



# iTool User's Guide

**RSI**

IDL Version 6.2  
July 2005 Edition  
Copyright © RSI  
All Rights Reserved

## Restricted Rights Notice

The IDL<sup>®</sup>, ION Script<sup>™</sup>, and ION Java<sup>™</sup> software programs and the accompanying procedures, functions, and documentation described herein are sold under license agreement. Their use, duplication, and disclosure are subject to the restrictions stated in the license agreement. RSI reserves the right to make changes to this document at any time and without notice.

## Limitation of Warranty

RSI makes no warranties, either express or implied, as to any matter not expressly set forth in the license agreement, including without limitation the condition of the software, merchantability, or fitness for any particular purpose.

RSI shall not be liable for any direct, consequential, or other damages suffered by the Licensee or any others resulting from use of the IDL or ION software packages or their documentation.

## Permission to Reproduce this Manual

If you are a licensed user of this product, RSI grants you a limited, nontransferable license to reproduce this particular document provided such copies are for your use only and are not sold or distributed to third parties. All such copies must contain the title page and this notice page in their entirety.

## Acknowledgments

IDL<sup>®</sup> is a registered trademark and ION<sup>™</sup>, ION Script<sup>™</sup>, ION Java<sup>™</sup>, are trademarks of ITT Industries, registered in the United States Patent and Trademark Office, for the computer program described herein.

Numerical Recipes<sup>™</sup> is a trademark of Numerical Recipes Software. Numerical Recipes routines are used by permission.

GRG2<sup>™</sup> is a trademark of Windward Technologies, Inc. The GRG2 software for nonlinear optimization is used by permission.

NCSA Hierarchical Data Format (HDF) Software Library and Utilities  
Copyright 1988-2001 The Board of Trustees of the University of Illinois  
All rights reserved.

NCSA HDF5 (Hierarchical Data Format 5) Software Library and Utilities  
Copyright 1998-2002 by the Board of Trustees of the University of Illinois. All rights reserved.

CDF Library  
Copyright © 2002 National Space Science Data Center  
NASA/Goddard Space Flight Center

NetCDF Library  
Copyright © 1993-1999 University Corporation for Atmospheric Research/Unidata

HDF EOS Library  
Copyright © 1996 Hughes and Applied Research Corporation

This software is based in part on the work of the Independent JPEG Group.

Portions of this software are copyrighted by DataDirect Technologies, 1991-2003.

Portions of this software were developed using Unisearch's Kakadu software, for which Kodak has a commercial license. Kakadu Software. Copyright © 2001. The University of New South Wales, UNSW, Sydney NSW 2052, Australia, and Unisearch Ltd, Australia.

Portions of this computer program are copyright © 1995-1999 LizardTech, Inc. All rights reserved. MrSID is protected by U.S. Patent No. 5,710,835. Foreign Patents Pending.

Portions of this software are copyrighted by Merge Technologies Incorporated.

This product includes software developed by the Apache Software Foundation (<http://www.apache.org/>)

IDL Wavelet Toolkit Copyright © 2002 Christopher Torrence.

Other trademarks and registered trademarks are the property of the respective trademark holders.



# Contents

|   |           |
|---|-----------|
| <b>Chapter 1</b>                          |           |
| <b>Introducing the IDL iTools</b> .....   | <b>17</b> |
| Introducing the iTools .....              | 18        |
| Using This Guide .....                    | 20        |
| <b>Chapter 2</b>                          |           |
| <b>Importing and Exporting Data</b> ..... | <b>23</b> |
| About the Data Manager .....              | 24        |
| Data Manager Interface .....              | 25        |
| Data Item Management .....                | 26        |
| Data Import Methods .....                 | 27        |
| Using the Data Import Wizard .....        | 28        |
| Using File Open .....                     | 32        |
| Using the Data Manager Dialog .....       | 33        |
| Importing Data from a File .....          | 34        |

|   |           |
|---|-----------|
| Importing Image Data .....                  | 34        |
| Importing ASCII Data .....                  | 34        |
| Importing Binary Data .....                 | 35        |
| Importing Shapefile Data .....              | 36        |
| Working with Unknown Data .....             | 37        |
| Using the Gridding Wizard .....             | 38        |
| Importing Data from the IDL Session .....   | 41        |
| Importing Graphic Objects .....             | 42        |
| Parameter Data and the Command Line .....   | 42        |
| Exporting Data .....                        | 44        |
| Exporting Data to a File .....              | 45        |
| Exporting Data to the IDL Session .....     | 48        |
| <b>Chapter 3</b>                            |           |
| <b>Visualizations .....</b>                 | <b>51</b> |
| About Visualizations .....                  | 52        |
| Visualization Creation Methods .....        | 53        |
| Creating Visualizations Automatically ..... | 53        |
| Inserting Visualizations .....              | 54        |
| Modifying Existing Visualizations .....     | 56        |
| The Parameter Editor .....                  | 56        |
| Removing Data Associations .....            | 57        |
| Replacing Data Associations .....           | 57        |
| Exporting Visualizations .....              | 58        |
| Exporting to a File .....                   | 58        |
| <b>Chapter 4</b>                            |           |
| <b>Manipulating the Display .....</b>       | <b>59</b> |
| Introduction .....                          | 60        |
| Selection of Objects .....                  | 61        |
| Select All .....                            | 61        |
| Undo/Redo .....                             | 62        |
| Adding a Data Space .....                   | 63        |
| Translation .....                           | 64        |
| Scaling .....                               | 65        |
| Zooming .....                               | 70        |
| Canvas Zoom .....                           | 70        |

|   |            |
|---|------------|
| View Zoom .....                           | 70         |
| View Panning .....                        | 72         |
| Window Layouts .....                      | 73         |
| <b>Chapter 5</b>                          |            |
| <b>Adding Annotations .....</b>           | <b>75</b>  |
| Introduction .....                        | 76         |
| Legends .....                             | 77         |
| Annotations .....                         | 79         |
| Text Annotations .....                    | 79         |
| Line Annotations .....                    | 80         |
| Rectangle Annotations .....               | 81         |
| Oval Annotations .....                    | 81         |
| Polygon Annotations .....                 | 82         |
| Freehand Annotations .....                | 83         |
| Additional Axes .....                     | 84         |
| <b>Chapter 6</b>                          |            |
| <b>Property Sheets and Browsers .....</b> | <b>85</b>  |
| Introduction .....                        | 86         |
| Property Sheets .....                     | 87         |
| Visualization Property Sheets .....       | 88         |
| Operations Property Sheets .....          | 88         |
| The Visualization Browser .....           | 90         |
| The Operations Browser .....              | 93         |
| The Preferences Browser .....             | 95         |
| General Settings .....                    | 97         |
| File Readers .....                        | 99         |
| File Writers .....                        | 104        |
| <b>Chapter 7</b>                          |            |
| <b>Common Operations .....</b>            | <b>109</b> |
| Introduction .....                        | 110        |
| File Operations .....                     | 111        |
| Opening Files .....                       | 111        |
| Importing Variables and Files .....       | 111        |
| Saving Files .....                        | 111        |

|  |            |
|--|------------|
| Exporting Variables and Files .....        | 112        |
| Exiting the iTool .....                    | 112        |
| Rotation .....                             | 113        |
| Mouse Rotation .....                       | 113        |
| Rotate Left and Rotate Right .....         | 115        |
| Rotate by Specified Angle .....            | 116        |
| Transformations .....                      | 117        |
| Resample .....                             | 117        |
| Rotate Data .....                          | 118        |
| Scale Data .....                           | 119        |
| Filtering .....                            | 120        |
| Smooth Filter .....                        | 120        |
| Median Filter .....                        | 121        |
| Convolution Filter .....                   | 122        |
| Unsharp Mask Filter .....                  | 123        |
| Morphing .....                             | 125        |
| Additional Operations .....                | 126        |
| Plotting a Histogram .....                 | 126        |
| Displaying Statistics .....                | 127        |
| Resetting Dataspace Ranges .....           | 129        |
| Rendering Translucent Objects .....        | 130        |
| Operations on Regions of Interest .....    | 131        |
| Operations Modifying ROI Data .....        | 131        |
| Operations Modifying ROI Vertices .....    | 131        |
| Printing .....                             | 132        |
| Print Preview .....                        | 132        |
| <b>Chapter 8</b>                           |            |
| <b>Working with Macros .....</b>           | <b>137</b> |
| Introduction .....                         | 138        |
| What Are Macros? .....                     | 139        |
| Recording Macros .....                     | 141        |
| Capturing Intermediate Manipulations ..... | 142        |
| Running Macros .....                       | 144        |
| Running from the Operations Menu .....     | 145        |
| Running from the Macro Editor .....        | 146        |

|   |            |
|---|------------|
| Running from the Command Line .....                   | 146        |
| Using the Macro Controls Dialog .....                 | 147        |
| Using the Macro Editor .....                          | 151        |
| Understanding the Macro Editor .....                  | 152        |
| Understanding Items in the Macro Editor .....         | 161        |
| Macro Items .....                                     | 161        |
| Source Items .....                                    | 162        |
| Making Selection and Tool Changes .....               | 176        |
| Macro Type Based on Recording Selection .....         | 176        |
| About Containers .....                                | 176        |
| Selection Changes .....                               | 177        |
| Tool Changes .....                                    | 180        |
| Importing and Exporting Macros .....                  | 183        |
| <b>Chapter 9</b>                                      |            |
| <b>Working with Styles .....</b>                      | <b>185</b> |
| What Are Styles? .....                                | 186        |
| Type of Styles .....                                  | 186        |
| Applying a Style .....                                | 187        |
| Creating Styles .....                                 | 188        |
| Creating a Style from the Current Visualization ..... | 188        |
| Creating a New Style from the Style Editor .....      | 191        |
| Working with the Current Style .....                  | 193        |
| Copying an Existing Style .....                       | 193        |
| Applying Styles .....                                 | 194        |
| Applying a Style to a Selected Item .....             | 194        |
| Applying a Style to All Items .....                   | 197        |
| Applying a Style When Launching an iTool .....        | 198        |
| Editing Styles .....                                  | 200        |
| Copying Properties Within Styles .....                | 200        |
| Cutting and Deleting Properties within Styles .....   | 201        |
| Selecting Multiple Properties for Editing .....       | 201        |
| Setting the Default Style .....                       | 203        |
| Importing and Exporting Styles .....                  | 204        |
| Exporting a File to Share .....                       | 204        |
| Importing a Received File .....                       | 204        |

|  |            |
|--|------------|
| <b>Chapter 10</b>                                |            |
| <b>Working with Images</b> .....                 | <b>205</b> |
| Introduction .....                               | 206        |
| Displaying Images .....                          | 207        |
| Displaying Multiple Images .....                 | 208        |
| Using the Image Panel .....                      | 211        |
| Image ROIs .....                                 | 212        |
| The Palette Editor .....                         | 212        |
| Window Level Control .....                       | 213        |
| Image Properties .....                           | 214        |
| Modifying Properties .....                       | 214        |
| Adding a Colorbar .....                          | 215        |
| Adding Axes .....                                | 216        |
| Resampling an Image .....                        | 217        |
| Filtering an Image .....                         | 218        |
| Convolving an Image .....                        | 218        |
| Applying a Median Filter .....                   | 218        |
| Smoothing an Image .....                         | 218        |
| Applying a Roberts Filter .....                  | 219        |
| Applying a Sobel Filter .....                    | 219        |
| Applying an Unsharp Mask .....                   | 219        |
| Applying a Morphological Operator .....          | 220        |
| Contouring an Image .....                        | 221        |
| Surfacing an Image .....                         | 223        |
| Manipulating the Image Display .....             | 224        |
| Rotating an Image .....                          | 224        |
| Scaling an Image and Byte Scaling an Image ..... | 224        |
| Inverting an Image .....                         | 224        |
| Flipping an Image .....                          | 224        |
| View Zoom .....                                  | 225        |
| Canvas Zoom .....                                | 225        |
| Pixel Scaling .....                              | 225        |
| Region Growing .....                             | 225        |
| Adding Annotations .....                         | 226        |
| Line Profiles .....                              | 226        |
| View Panning .....                               | 227        |



|                                     |            |
|-------------------------------------|------------|
| Cropping an Image .....             | 227        |
| iImage Tool Operations .....        | 229        |
| Viewing a Histogram .....           | 229        |
| Viewing Image Statistics .....      | 229        |
| Cropping Images .....               | 229        |
| <b>Chapter 11</b>                   |            |
| <b>Working with Surfaces .....</b>  | <b>231</b> |
| Introduction .....                  | 232        |
| Displaying Surfaces .....           | 233        |
| Surface Properties .....            | 235        |
| The Visualization Browser .....     | 235        |
| The Operations Browser .....        | 235        |
| Adding a Colorbar .....             | 237        |
| Adding a Light .....                | 238        |
| Adding a Legend .....               | 239        |
| Adding Axes .....                   | 240        |
| Imaging a Surface .....             | 241        |
| Contouring a Surface .....          | 242        |
| Resampling a Surface .....          | 244        |
| Filtering a Surface .....           | 245        |
| Convolving a Surface .....          | 245        |
| Median a Surface .....              | 245        |
| Smoothing a Surface .....           | 245        |
| Adding a Texture Map .....          | 246        |
| Manipulating Surface Displays ..... | 247        |
| Rotating a Surface .....            | 247        |
| Scaling a Surface .....             | 249        |
| Adding Annotations .....            | 250        |
| View Zoom .....                     | 250        |
| Canvas Zoom .....                   | 250        |
| Extracting a Line Profile .....     | 251        |
| iSurface Tool Operations .....      | 252        |
| Viewing a Histogram Plot .....      | 252        |
| Viewing Statistics .....            | 252        |

|  |            |
|--|------------|
| <b>Chapter 12</b>                        |            |
| <b>Working with Contours</b> .....       | <b>253</b> |
| Introduction .....                       | 254        |
| Displaying Contours .....                | 255        |
| Displaying Regular-grid Data .....       | 255        |
| Displaying Irregular-grid Data .....     | 256        |
| Contour Properties .....                 | 262        |
| Labelling Contours .....                 | 264        |
| Changing the Contour Colors .....        | 266        |
| Filling Contours .....                   | 267        |
| Adding a Colorbar .....                  | 269        |
| Adding a Legend .....                    | 270        |
| Adding Axes .....                        | 271        |
| Filtering a Contour .....                | 272        |
| Contour Smoothing .....                  | 272        |
| Contour Convolution .....                | 273        |
| Manipulating the Contour Display .....   | 274        |
| Translating .....                        | 274        |
| View Zoom .....                          | 274        |
| Flipping a Contour .....                 | 274        |
| Canvas Zoom .....                        | 274        |
| Scaling a Contour Display .....          | 275        |
| Adding Annotations .....                 | 275        |
| iContour Tool Operations .....           | 277        |
| Viewing a Histogram .....                | 277        |
| Viewing Statistics .....                 | 277        |
| <b>Chapter 13</b>                        |            |
| <b>Working with Plots</b> .....          | <b>279</b> |
| Introduction .....                       | 280        |
| Displaying Two-Dimensional Plots .....   | 281        |
| Displaying Three-Dimensional Plots ..... | 282        |
| Displaying Polar Plots .....             | 283        |
| Overplotting .....                       | 284        |
| Plot Properties .....                    | 286        |
| Modifying Properties .....               | 286        |

|   |            |
|---|------------|
| Adding Legends .....                    | 287        |
| Adding a Colorbar .....                 | 289        |
| Adding Error Bars .....                 | 290        |
| Curve Fitting .....                     | 292        |
| Filtering a Plot .....                  | 295        |
| Plot Smoothing .....                    | 295        |
| Plot Convolution .....                  | 296        |
| Plot Median .....                       | 296        |
| Manipulating the Plot Display .....     | 297        |
| Translating .....                       | 297        |
| Adding Annotations .....                | 297        |
| View Zoom .....                         | 298        |
| Canvas Zoom .....                       | 298        |
| Selecting the Data Range .....          | 298        |
| iPlot Tool Operations .....             | 299        |
| Scaling a Plot Display .....            | 299        |
| Viewing a Histogram .....               | 299        |
| Viewing Statistics .....                | 299        |
| <b>Chapter 14</b>                       |            |
| <b>Working with Volumes .....</b>       | <b>301</b> |
| Introduction .....                      | 302        |
| Displaying Volumes .....                | 303        |
| Multi-Channel Volumes .....             | 303        |
| Rendering Volumes .....                 | 304        |
| Using the Volume Panel .....            | 307        |
| Volume Properties .....                 | 309        |
| Modifying Properties .....              | 309        |
| Adding a Colorbar .....                 | 310        |
| Adding Axes .....                       | 311        |
| Resampling Volumes .....                | 312        |
| Showing an Image Plane .....            | 313        |
| Viewing the Image Plane in iImage ..... | 313        |
| Extracting an IsoSurface .....          | 314        |
| Extracting an Interval Volume .....     | 316        |
| Manipulating the Volume Display .....   | 318        |

|                               |     |
|-------------------------------|-----|
| Rotating a Volume .....       | 318 |
| Scaling a Volume .....        | 318 |
| View Zoom .....               | 318 |
| Canvas Zoom .....             | 318 |
| Adding Annotations .....      | 318 |
| iVolume Tool Operations ..... | 320 |
| Viewing a Histogram .....     | 320 |
| Viewing Statistics .....      | 320 |
| Smoothing a Volume .....      | 320 |
| Opening an Image Stack .....  | 320 |

## **Chapter 15**

### **Working with Maps ..... 323**

|   |     |
|---|-----|
| Introduction .....                              | 324 |
| Displaying Maps .....                           | 325 |
| Applying a Map Projection .....                 | 326 |
| Using the Map Panel .....                       | 330 |
| Displaying an Image .....                       | 332 |
| Registering an Image .....                      | 333 |
| Registering an Image in Meters .....            | 335 |
| Registering an Image in Degrees .....           | 338 |
| Displaying a Contour .....                      | 340 |
| Creating a Shape Visualization .....            | 341 |
| Inserting a Map Grid .....                      | 342 |
| Inserting an IDL Shapefile .....                | 343 |
| Inserting the Continents .....                  | 343 |
| Inserting the Countries (Low Resolution) .....  | 344 |
| Inserting the Countries (High Resolution) ..... | 344 |
| Inserting the Rivers .....                      | 345 |
| Inserting the Lakes .....                       | 346 |
| Inserting the United States .....               | 347 |
| Inserting the Canadian Provinces .....          | 348 |

## **Appendix A**

### **iTools Interface Reference ..... 351**

|   |     |
|---|-----|
| Introduction to iTools Interface Elements ..... | 352 |
| Menu Bar Items .....                            | 352 |

|                           |     |
|---------------------------|-----|
| Toolbar Items .....       | 352 |
| File Menu .....           | 353 |
| Edit Menu .....           | 355 |
| Insert Menu .....         | 358 |
| Operations Menu .....     | 359 |
| Window Menu .....         | 362 |
| Help Menu .....           | 363 |
| File Toolbar .....        | 364 |
| Edit Toolbar .....        | 365 |
| Manipulator Toolbar ..... | 366 |
| Annotation Toolbar .....  | 367 |
| Context Menu .....        | 368 |

## **Appendix B**

### **Property Controls ..... 371**

## **Appendix C**

### **Operations Properties ..... 375**

|                                  |     |
|----------------------------------|-----|
| The Operations Browser .....     | 376 |
| Macros Properties .....          | 377 |
| Statistics Properties .....      | 378 |
| Histogram Properties .....       | 379 |
| Filter Properties .....          | 380 |
| Convolution Properties .....     | 380 |
| Median Properties .....          | 382 |
| Smooth Properties .....          | 383 |
| Roberts Filter Properties .....  | 383 |
| Sobel Filter Properties .....    | 383 |
| Unsharp Mask Properties .....    | 384 |
| Curve Fitting Properties .....   | 384 |
| Rotate Properties .....          | 387 |
| Rotate Left Properties .....     | 387 |
| Rotate Right Properties .....    | 387 |
| Rotate By Angle Properties ..... | 387 |
| Flip Horizontal .....            | 387 |
| Flip Vertical .....              | 387 |
| Transform Properties .....       | 388 |

|                                     |     |
|-------------------------------------|-----|
| Resample Properties .....           | 388 |
| Rotate Data Properties .....        | 389 |
| Scale Data Properties .....         | 390 |
| Invert Image Properties .....       | 391 |
| Byte Scale Properties .....         | 391 |
| Map Projection Properties .....     | 392 |
| Map Register Image Properties ..... | 393 |
| Morphing Properties .....           | 394 |
| Crop Properties .....               | 395 |
| Region Grow Properties .....        | 396 |
| Contour Properties .....            | 398 |
| Image Properties .....              | 399 |
| Surface Properties .....            | 400 |
| Volume Properties .....             | 401 |
| Image Plane .....                   | 401 |
| Isosurface .....                    | 401 |
| Render Volume .....                 | 401 |
| Interval Volume .....               | 402 |
| Image Plane Properties .....        | 403 |
| Launch iImage .....                 | 404 |

## Appendix D

|  |            |
|--|------------|
| <b>Visualization Properties .....</b>          | <b>405</b> |
| Introduction to Visualization Properties ..... | 406        |
| The Visualization Browser .....                | 407        |
| Window Properties .....                        | 408        |
| View Properties .....                          | 410        |
| Visualization Layer Properties .....           | 411        |
| Data Space Properties .....                    | 413        |
| Rendering Objects at Data Space Depth .....    | 416        |
| Visualization Type Properties .....            | 417        |
| Image .....                                    | 418        |
| Plot .....                                     | 421        |
| Plot 3D .....                                  | 425        |
| Surface .....                                  | 428        |
| Contour .....                                  | 432        |

|  |            |
|--|------------|
| Volume .....                             | 437        |
| Isosurface .....                         | 443        |
| Interval Volume .....                    | 445        |
| Image Plane .....                        | 447        |
| Colorbar .....                           | 450        |
| Histogram .....                          | 454        |
| Axes .....                               | 458        |
| Lights .....                             | 466        |
| Polygonal ROI .....                      | 469        |
| IDL Graphics Objects .....               | 471        |
| Map Grid .....                           | 472        |
| ShapePolygon .....                       | 476        |
| ShapePolyline .....                      | 478        |
| ShapePoint .....                         | 479        |
| 2D Annotation Layer Properties .....     | 480        |
| Text Annotation Properties .....         | 481        |
| Line Annotation Properties .....         | 483        |
| Line Profile Annotation Properties ..... | 484        |
| Rectangle Annotation Properties .....    | 487        |
| Oval Annotation Properties .....         | 488        |
| Polygon Annotation Properties .....      | 489        |
| Freehand Annotation Properties .....     | 490        |
| Legend Properties .....                  | 491        |
| Legend Contour Items .....               | 495        |
| Legend Contour Level Items .....         | 496        |
| Legend Plot Items .....                  | 498        |
| Legend Surface Items .....               | 499        |
| <b>Index .....</b>                       | <b>501</b> |







# Chapter 1

# Introducing the IDL iTools

This chapter introduces you to the new IDL iTools and aids in using this guide.

---

|                              |    |                        |    |
|------------------------------|----|------------------------|----|
| Introducing the iTools ..... | 18 | Using This Guide ..... | 20 |
|------------------------------|----|------------------------|----|

# Introducing the iTools

The new IDL Intelligent Tools (iTools) are a set of interactive utilities that combine data analysis and visualization with the task of producing presentation quality graphics. Based on the IDL Object Graphics system, the iTools are designed to help you get the most out of your data with minimal effort. They allow you to continue to benefit from the control of a programming language, while enjoying the convenience of a point-and-click environment.

In IDL 6.1, six pre-built iTools are exposed for immediate interactive use. Each of these six tools is designed around a specific data or visualization type, including:

- Two- and three-dimensional plots (line, scatter, polar, and histogram style)
- Surface representations
- Contour data
- Map data
- Image displays
- Volume visualizations

The iTools are built upon a new object-oriented framework, or set of object classes, that serve as the building blocks for the interface and functionality of the iTools. IDL programmers can easily use this framework to create custom data analysis and visualization environments. Such custom iTools may be called from within a larger IDL application, or they may serve as the foundation for a complete application in themselves.

## A Single Tool with Many Faces

What sets the iTools apart from precursors such as the Live Tools (now obsolete) — and what gives them their optimal power, flexibility, and extensibility — is the cohesive, open architecture of the iTools system. The iTools system is actually comprised of a single tool, which adapts to handle the data that you pass to it. The plot, surface, image, contour, and volume tools are simply shortcut configurations, which facilitate ad hoc data analysis and visualization. Each tool encapsulates the functionality (data operations, display manipulations, and visualization types) required to handle its data or visualization type. However, you are not constrained to work with a single data or visualization type. Instead, using the iTools system, you may start by bringing up a surface plot in a surface tool and then import scattered point data into the same plot to see the relationship between two data sets. Or, you may start with an image display, overlay contours from another data set, and map

both the image and contours onto a three-dimensional surface representation of a third data set. By throwing new data into an iTool, it is easy to end up with a hybrid tool that can handle complex, composite visualizations.

Of course, you have always been able to create these kinds of powerful, composite visualizations in IDL to reveal important relationships and trends in data. The main enhancements the new iTools provide are more mouse interactivity, WYSIWYG (What-You-See-Is-What-You-Get) printing, built-in analysis, undo-redo capabilities, layout control, and better-looking plots. These robust, pre-built tools reduce the amount of programming IDL users must do to create interactive visualizations. At the same time, the iTools integrate in a seamless manner with the IDL Command Line, user interface controls, and custom algorithms. In this way, the iTools maintain and enhance the control and flexibility IDL users rely on for data exploration, algorithm design, and rapid application development.

## Foundation for the Future

As you will discover, the iTools are compelling new tools to add to your arsenal. They complement the strong foundation that IDL has maintained over the course of its evolution. This foundation has made possible countless valuable user-written applications across many disciplines and industries. However, the iTools also represent the start of a new, updated display paradigm for IDL. While the iTools system in IDL 6.1 is a powerful and flexible environment that will allow you to immediately accelerate your data interpretation and reporting, it is only the beginning. We will continue to build on this new technology in future releases. You can look forward to more functionality, flexibility, and optimization as the iTools system continues to grow.

We look forward to members of the IDL community building on the iTools system as well. The iTools source code is included in the IDL distribution to allow you to:

- extend the pre-built tools with your own operations, manipulations, visualization types, and GUI controls
- create your own custom tools based on the iTools component framework
- share your inventions with others in the IDL community via the RSI User-Contributed Library ([www.RSInc.com/codebank](http://www.RSInc.com/codebank)) or other avenues of collaboration and distribution

---

### Note

For more information on building your own iTools or building hybrid iTools, see the *iTool Developer's Guide*.

---

Tips and instructions for using this guide are detailed in the following section.

# Using This Guide

The *iTool User Guide* can show you important iTool functionality such as how to start the iTools, how to import data into an iTool, how to export data out of an iTool, the general layout of the iTools, and how to perform common iTool tasks.

This *User Guide* is organized to help you make the most of the IDL iTools. The User Guide contains the following chapters:

- [Chapter 2, “Importing and Exporting Data”](#) — This chapter introduces you to bringing data into the iTools as well as exporting data.
- [Chapter 3, “Visualizations”](#) — This chapter introduces what an iTool visualization is and how to work with visualizations.
- [Chapter 4, “Manipulating the Display”](#) — This chapter describes the various ways that you can manipulate your displays within an iTool.
- [Chapter 5, “Adding Annotations”](#) — This chapter describes the various types of annotations available in iTools and how to work with them.
- [Chapter 6, “Property Sheets and Browsers”](#) — This chapter describes the property sheets and browsers that are common to all iTools.
- [Chapter 7, “Common Operations”](#) — Many iTool operations are common to each tool. These operations are described in this chapter.
- [Chapter 8, “Working with Macros”](#) — This chapter describes macros in iTools and how they are created and used.
- [Chapter 9, “Working with Styles”](#) — This chapter describes iTool styles and how to create and work with them.
- [Chapter 10, “Working with Images”](#) — This chapter describes the iImage tool and gives you insight into unique image visualization and manipulation tasks.
- [Chapter 11, “Working with Surfaces”](#) — This chapter describes the iSurface tool and gives you insight into unique surfacing and surface manipulation tasks.
- [Chapter 12, “Working with Contours”](#) — This chapter describes the iContour tool and gives you insight into unique contouring and contour manipulation tasks.
- [Chapter 13, “Working with Plots”](#) — This chapter describes the iPlot tool and gives you insight into unique plotting and plot manipulation tasks.

- [Chapter 14, “Working with Volumes”](#) — This chapter describes the iVolume tool and gives you insight into unique volume visualization and volume manipulation tasks.
- [Chapter 15, “Working with Maps”](#) — This chapter describes the iMap tool and gives you insight into unique mapping and map manipulation tasks.
- [Appendix A, “iTools Interface Reference”](#) — This appendix gives you a detailed look at the iTool interface and its components.
- [Appendix B, “Property Controls”](#) — This appendix describes the iTool controls used to set properties in the iTool property sheets.
- [Appendix C, “Operations Properties”](#) — This appendix describes the properties of the iTools found in the Operations Browser of each iTool.
- [Appendix D, “Visualization Properties”](#) — This appendix describes the properties of the iTools found in the Visualization Browser of each iTool.





## Chapter 2

# Importing and Exporting Data

This chapter describes how to access data using the iTool.

---

|                                  |    |   |    |
|----------------------------------|----|---|----|
| About the Data Manager .....     | 24 | Importing Data from the IDL Session ..... | 41 |
| Data Import Methods .....        | 27 | Parameter Data and the Command Line ..    | 42 |
| Importing Data from a File ..... | 34 | Exporting Data .....                      | 44 |
| Working with Unknown Data .....  | 37 |   |    |

## About the Data Manager

All data used by any iTool is first loaded into the iTools *Data Manager*, which keeps track of which data items are associated with an iTool visualization. The Data Manager provides a convenient and structured environment in which to import and view files and variables.

The process of loading data into the Data Manager is entirely automatic if you specify data when launching an iTool at the IDL command line or if you open a data file using the **Open** command from the iTool's **File** menu. In these cases, the iTool will import the data in the specified file or variable and create a visualization of the default type for the selected data and the iTool you are using.

If you want more control over the process of creating a visualization, you can load data into the Data Manager manually, either from a data file or from one or more variables that exist in your current IDL session. Once a data item is placed in the Data Manager, it is available to all iTools until it is removed.

The IDL iTools support several *data types*. Data import and export capabilities within each iTool allow you to access these various types of data. Methods used to place data into the Data Manager are described in [this chapter](#). *File readers* allow you to import data stored in binary formats, ASCII files, and several image file types.

---

### Note

You can also create file readers for other data types besides those provided in IDL. For more information on creating file readers and creating your own iTools, see [Chapter 9, “Creating a File Reader”](#) in the *iTool Developer's Guide* manual.

---



## Data Manager Interface

The Data Manager's graphical user interface consists of these elements:

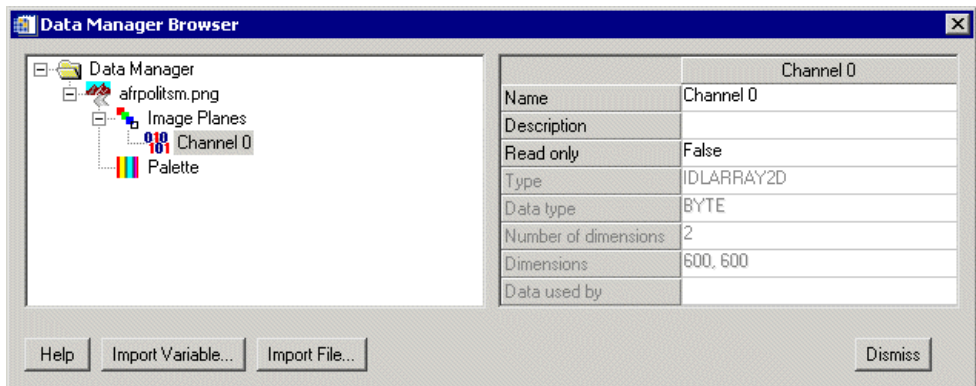

Figure 2-1: The iTools Data Manager

- **Data Tree View** — This window, on the left side of the dialog, shows all of the data items available within the Data Manager. Depending on how data items were added to the Data Manager, they may be collected into groups of related items; for example, individual image channels associated with a true-color image will show up underneath the Data Manager entry for the image itself. The data tree view will be empty unless you have read or imported data into the Data Manager.
- **Data Properties** — This window, on the right side of the dialog, shows you all properties and their values for the data item selected in the data tree view.
- **Help** — This button will invoke the IDL online help system.
- **Import Variable** — This button allows you to select a variable in the IDL Main scope to import into the Data Manager. For more information on importing a variable into your Data Manager, see [“Importing Data from the IDL Session”](#) on page 41.
- **Import File** — This button allows you to select a data file to import into the Data Manager.
- **Dismiss** — This button will dismiss the dialog.

## Data Item Management

In addition to the ability to import new data into the Data Manager, you can rename, duplicate, or remove existing data items.

- **Renaming data** — To rename a data item, enter a new name in the **Name** field on the data property sheet.
- **Deleting data** — To delete an unused or outdated data item, select the item in the tree view, click the right mouse button to display the Data Manager context menu, and choose the **Delete** option.

---

**Note**

Deletion is not reversible.

---

- **Duplicating data** — To create a copy of an existing data item, select the item in the tree view, click the right mouse button to display the Data Manager context menu, and choose the **Duplicate** option.

# Data Import Methods

Data items in the Data Manager are available to all iTools until it they are removed. You can bring data into the iTool Data Manager in the following ways:

- Using the Data Import Wizard (**File** → **Import**)
- By opening a data file directly (**File** → **Open**)
- Using the **Import Variable ...** or **Import File...** buttons on the Data Manager dialog (**Window** → **Data Manager**)
- By specifying data parameters at the IDL command line. For example, specifying the following at the IDL command line:

```
iPlot, myDataVariable
```

places the variable `myDataVariable` in the Data Manager.

These methods are described in the following sections.

- [“Using the Data Import Wizard”](#) on page 28
- [“Using File Open”](#) on page 32
- [“Using the Data Manager Dialog”](#) on page 33
- [“Importing Data from the IDL Session”](#) on page 41

---

**Note**

Once data has been imported into the iTool and is visible in the Data Manager, there are a numerous ways to visualize the data. To learn more about visualizing data, see [Chapter 3, “Visualizations”](#).

---

# Using the Data Import Wizard

The iTool *Data Import Wizard* steps you through the process of importing data into the Data Manager. Launch the Data Import Wizard by selecting **File** → **Import...** The Data Import Wizard has three screens:

## 1. Select the data source.

You can import data either from a data file or from the IDL session:

- **From a File** — allows you to select a data file to import.
- **From an IDL Variable** — allows you to select an IDL variable to import. For more information on importing a variable into your Data Manager, see [“Importing Data from the IDL Session”](#) on page 41.

## 2. Select the data and specify a data name.

If you are importing data from a file, the second screen of the Data Import Wizard contains the following items:

- **File Name** — The full path of the file want to open. You can populate this field using a standard dialog by clicking the **File Open** button.
- **File Open** button  — Displays the standard file-selection dialog.
- **File Type** — After a file is selected, the **File Type** field displays the format of the file.
- **Type Properties Window** — After a file is selected the properties window shows properties of the file reader that will import the data, if any exist. Modify these properties as necessary to import your data correctly.

### Note

---

For more information about file format types that are available in iTools, see [“File Readers”](#) on page 99.

---

- **Data Import Name** — The name that will be used for the imported data in the Data Manager.

Importing some types of data files may cause IDL to present additional screens that describe the data before import.

- For image data see [“Importing Image Data”](#) on page 34
- For ASCII data see [“Importing ASCII Data”](#) on page 34
- For binary data see [“Importing Binary Data”](#) on page 35

If you are importing data from an IDL variable, the second screen of the Data Import Wizard contains the following items:

- **List of IDL Variables** — All variables available in the current IDL session are listed in a tree view.
- **Variable Information** — Information about the selected variable is displayed to the right of the tree view.
- **Data Import Name** — The name that will be used for the imported data in the Data Manager.

### 3. Select the type of visualization you want to create.

The Data Import Wizard will automatically create a new visualization of the selected type. Choosing <Default> will create the default visualization for the selected data type, regardless of the type of iTool into which you are importing the data.

### Example: Importing a JPEG File

The following example describes how to import a JPEG image file using the Data Import Wizard and display the image:

1. From an iTool window select **File** → **Import**.

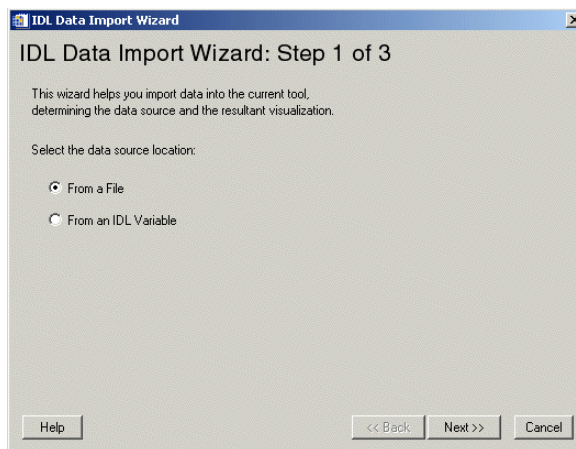

Figure 2-2: The IDL Data Import Wizard, Showing Step 1 of 3

2. Select **From a File** and click **Next**.

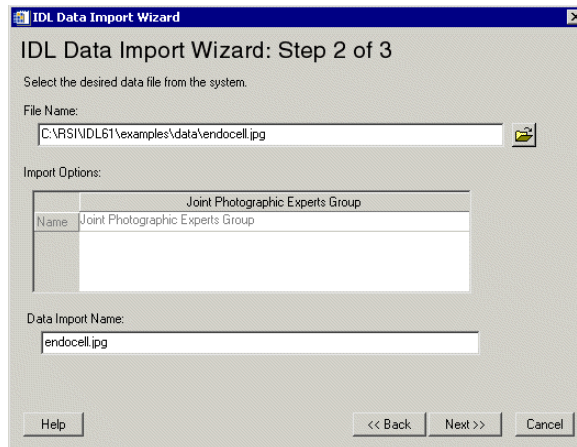



Figure 2-3: The IDL Data Import Wizard, Showing Step 2 of 3

3. Click the **File Open** button  just to the right of the **File Name** field and select the `endocell.jpg` file from the `examples/data` directory of the IDL distribution. Click **Next**.

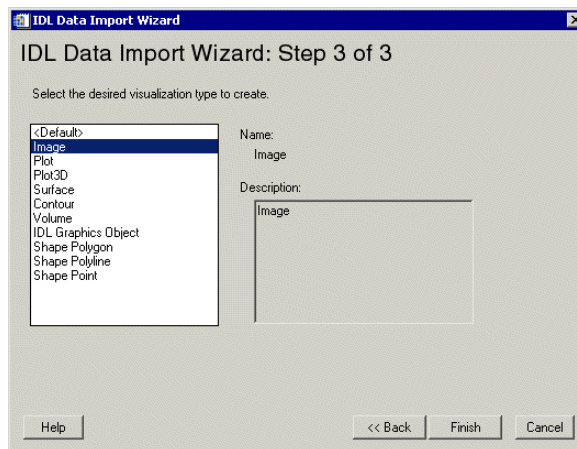

Figure 2-4: The IDL Data Import Wizard, Showing Step 3 of 3

4. Select **Image** as the desired visualization to create since we have a JPEG image.
5. Click **Finish**. The data is imported into the Data Manager, and a new image visualization appears in the iTool window.

---

**Note**

The process of creating visualizations is discussed in detail in [Chapter 3, “Visualizations”](#).

---

## Using File Open

Selecting a data file using **File** → **Open** will open the file using the default iTool file reader for the type of file you select. The data will be added to the Data Manager and the iTool will automatically create the default visualization for the data contained in the file.

If the data in the file you select is binary or ASCII, you will be prompted to specify further information that will allow the binary or ASCII file readers to correctly import the data. For an explanation of the handling of various file types see the following sections:

- For ASCII data see [“Importing ASCII Data”](#) on page 34
- For binary data see [“Importing Binary Data”](#) on page 35
- For ShapeFile data see [“Importing Shapefile Data”](#) on page 36
- For data of an unrecognized format see [“Working with Unknown Data”](#) on page 37



## Using the Data Manager Dialog

Selecting **Window** → **Data Manager** opens the Data Manager dialog. You can then click the **Import Variable...** or **Import File...** button.

### Importing a File

If you are importing data from a file, the File Import dialog appears. It contains the following items:

- **File name** — The full path of the file want to open. You can populate this field using a standard dialog by clicking the **File Open** button.
- **File Open** button  — displays the standard file-selection dialog.
- **Import options** — Displays a properties window shows properties of the file reader that will import the data, if any exist. Modify these properties as necessary to import your data correctly.

#### Note

---

For more information about file format types that are available in iTools, see [“File Readers”](#) on page 99.

---

- **Data import name** — The name that will be used for the imported data in the Data Manager.

### Importing a Variable

If you are importing data from an IDL variable, the IDL Variable Browser appears. It contains the following items:

- **List of IDL Variables** — All variables available in the current IDL session are listed in a tree view.
- **Variable Information** — Information about the selected variable is displayed to the right of the tree view.
- **Data Import Name** — The name that will be used for the imported data in the Data Manager.
- **Import Type** — The variable type to be used for the imported data in the Data Manager.

# Importing Data from a File

You can import data from several types of files into the iTool Data Manager. The following sections describe the process of importing different types of data.

- [“Importing Image Data”](#) on page 34
- [“Importing ASCII Data”](#) on page 34
- [“Importing Binary Data”](#) on page 35
- [“Importing Shapefile Data”](#) on page 36

## Importing Image Data

You can visualize image data stored in many common file formats. Common image file formats accepted are:

- DICOM Images
- Graphics Interchange Format Images (GIF)
- Joint Photographic Experts Group (JPEG)
- JPEG2000 (JP2 or JPX)
- Macintosh PICT
- Portable Network Graphics (PNG)
- Tag Image File Format (TIFF)
- Windows Bitmap (BMP)

---

### Note

You can also use the iTool’s export and export variable features to export image data and variables. For more information on exporting, see [“Exporting Data”](#) on page 44.

---

### Note

For more information on the iImage tool and its functions and features, see [Chapter 10, “Working with Images”](#).

---

## Importing ASCII Data

When you open a file containing ASCII data, you must specify the format of the file before the iTool can read the data and place it into the Data Manager. The iTool opens the **ASCII Template** dialog to allow you to specify the format of the ASCII data.

---

**Note**

You can also use the iTool's export and export variable features to export ASCII data and variables. For more information on exporting, see [“Exporting Data”](#) on page 44.

---

To import ASCII data in an iTool, select **File** → **Open** or click the **Import File** button in the Data Manager or Insert Visualization dialog. See [“Using the ASCII Template Dialog”](#) under [“ASCII\\_TEMPLATE”](#) in the *IDL Reference Guide* manual for instructions on how to use the dialog to define the structure of your ASCII data.

---

**Note**

Once data has been imported into the iTool and is visible in the Data Manager, there are a few ways to visualize the data. To learn more about visualizing data, see [Chapter 3, “Visualizations”](#).

---

For more information on using the ASCII file reader, see [“ASCII\\_TEMPLATE”](#) in the *IDL Reference Guide* manual.

## Importing Binary Data

When you open a file containing binary data that is not of a format recognized by any other file reader available to your iTool, you must specify the format of the file before the iTool can read the data and place it into the Data Manager. The iTool opens the **Binary Template** dialog to allow you to specify the format of the binary data.

---

**Note**

If the file contains binary data of a recognized format, such as TIFF or JPEG, the iTool will automatically choose the correct file reader to read the binary data.

---

---

**Note**

You can also use the iTool's export and export variable features to export binary data and variables. For more information on exporting, see [“Exporting Data”](#) on page 44.

---

To import binary data in an iTool, select **File** → **Open** or click the **Import File** button in the Data Manager or Insert Visualization dialog. See [“Using the BINARY\\_TEMPLATE Interface”](#) under [“BINARY\\_TEMPLATE”](#) in the *IDL Reference Guide* manual for instructions on how to use the dialog to define the structure of your binary data.

**Note** 

---

Once data has been imported into the iTool and is visible in the Data Manager, there are a few ways to visualize the data. To learn more about visualizing data, see [Chapter 3, “Visualizations”](#).

---

For more information on the binary file reader, see “[BINARY\\_TEMPLATE](#)” in the *IDL Reference Guide* manual.

For more information on plotting and plot functions, see [Chapter 13, “Working with Plots”](#).

## Importing Shapefile Data

For more information on shapefiles and inserting them into an iTool, see “[Inserting an IDL Shapefile](#)” on page 343.

**Note** 

---

Once data has been imported into the iTool and is visible in the Data Manager, there are a few ways to visualize the data. To learn more about visualizing data, see [Chapter 3, “Visualizations”](#).

---

# Working with Unknown Data

If you supply data in a format not recognized by the current iTool, the **Create Visualization** dialog allows you to specify how the data is to be used.

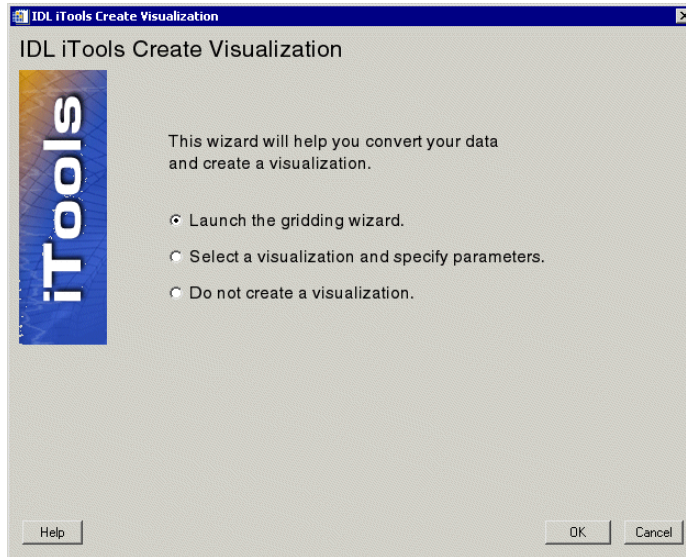

Figure 2-5: The iTools Create Visualization Dialog

You will see this dialog if the data you supply when launching an iTool from the IDL command line does not match a known data organization for the selected tool, or if you open an ASCII text file containing data that appears to be irregularly gridded.

The **Create Visualization** dialog contains the following choices:

- **Launch the gridding wizard**  
This option lets you transform irregularly-gridded data into regularly-gridded data using IDL's gridding routines. The resulting data is displayed by the iTool. See [“Using the Gridding Wizard”](#) on page 38 for details.
- **Select a visualization and specify parameters**  
This option lets you manually specify how the data should be assigned to a selected visualization's parameters.
- **Do not create a visualization**

## Using the Gridding Wizard

The iTools Gridding Wizard allows you to convert irregularly-gridded data into regularly-gridded data using a variety of methods. The gridding wizard processes your irregularly-gridded data in three steps.

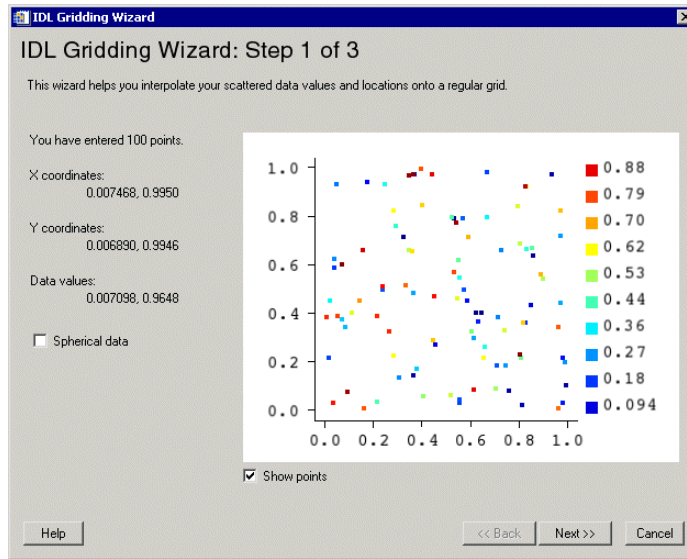
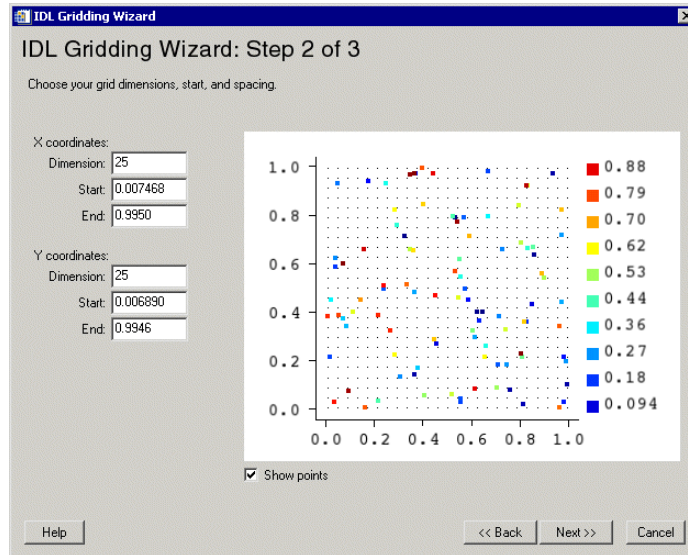

Figure 2-6: The IDL Gridding Wizard Step 1 of 3

The **IDL Gridding Wizard Step 1 of 3** dialog contains the following items:

- **Number of points entered**
- **X Coordinates** — The X coordinate range
- **Y Coordinates** — The Y coordinate range
- **Data values** — The data minimum and maximum values
- **Spherical data checkbox** — Check this box if the data is spherical
- **Coordinate diagram** — Shows coordinates of grid data
- **Show points checkbox** — Select to show all points (default = checked)
- **Help** — Obtain help on this dialog
- **Back** — Return to previous step

- **Next** — Proceed to Step 2 of 3
- **Cancel** — Dismiss the Gridding Wizard



*Figure 2-7: The IDL Gridding Wizard Step 2 of 3*

The **IDL Gridding Wizard Step 2 of 3** dialog contains the following items:

- **X Coordinates** — modify dimension, start or end
- **Y Coordinates** — modify dimension, start or end
- **Coordinate diagram** — shows coordinates of grid data
- **Show points checkbox** — select to show all points (default = checked)
- **Help** — obtain help on this dialog
- **Back** — return to previous step
- **Next** — proceed to Step 3 of 3
- **Cancel** — dismiss the Gridding Wizard

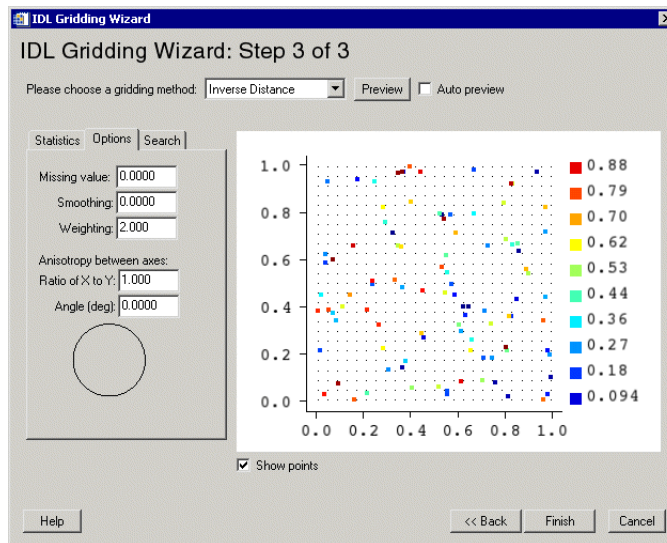

Figure 2-8: The IDL Gridding Wizard Step 3 of 3

The **IDL Gridding Wizard Step 3 of 3** dialog contains the following items:

- **Choose gridding method** — choose from pull-down list. See [“GRIDDATA”](#) in the *IDL Reference Guide* manual for a discussion of the gridding methods.
- **Preview** — click to preview selected method and data
- **Auto preview** — checkbox to turn auto preview on (default = off)
- **Statistics tab** — shows data statistics
- **Options tab** — set options for missing values, smoothing, weighting, and anisotropy between axes
- **Search tab** — set options for using search ellipse
- **Coordinate diagram** — shows coordinates of grid data
- **Show points checkbox** — select to show all points (default = checked)
- **Help** — obtain help on this dialog
- **Back** — return to previous step
- **Finish** — dismiss the Gridding Wizard with data gridded
- **Cancel** — dismiss the Gridding Wizard



# Importing Data from the IDL Session

Variables in your current IDL session can be imported into the Data Manager to be visualized in an iTool. Once you have entered variables into the IDL session at the command line, you can import a variable directly from the **Data Manager** dialog, or by using **File** → **Import**. See [Chapter 6, “Importing and Writing Data into Variables”](#) in the *Using IDL* manual for information on how to create variables that contain data within an IDL session.

## Note

If you specify a variable as a parameter to the iTool at the IDL command line, the variable is automatically imported into the Data Manager.

The following is an example of importing a variable using the **Data Manager** dialog:

1. From the **Data Manager** dialog, select **Import Variable**. The **IDL Variable Browser** appears.

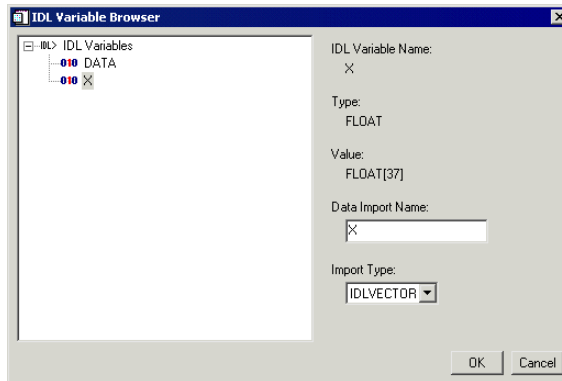

Figure 2-9: The IDL Variable Browser

2. From the **IDL Variable Browser** you can select available variables which you have created in your IDL session and click **OK** to add them to your Data Manager as available variables.

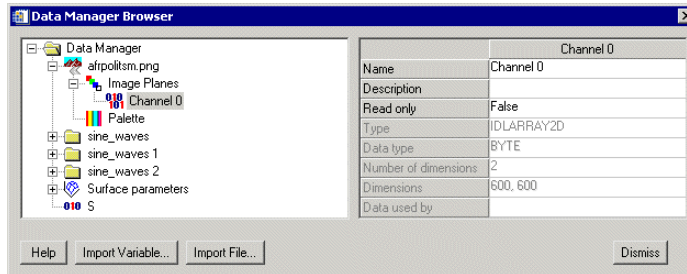

Figure 2-10: Imported Variable with Imported Files

After importing data into the Data Manager, you can display the data using the Insert Visualization dialog. See “[Inserting Visualizations](#)” on page 54 for details.

## Importing Graphic Objects

You can import graphic objects into your iTool using the **Visualization** pull-down menu on the **Insert Visualization** window. Select **IDL Graphics Object** and then import your variable from the Data Manager into the **Graphics Object** field and select **Insert**.

When importing graphic objects into an iTool it is important to remember:

- If the object hierarchy being inserted as a graphic object does not have the `REGISTER_PROPERTIES` keyword set, then no properties will be available in your iTool when the object is visualized.

If the object hierarchy being inserted as a graphic object includes an image object, rotation may not behave as expected. For more information on image objects and their behavior, see “[Transformations of IDLgrImage Objects](#)” in Chapter 8 of the *IDL Reference Guide* manual.

## Parameter Data and the Command Line

Parameter data can often be entered at the IDL command line in IDL when creating an iTool. Consider the following example:

1. At the IDL Command Line, enter the following:

```
myPlotData = RANDOMU(seed, 30)
iPlot, myPlotData
```

2. The variable `myPlotData` is inserted into the iTool Data Manager.
3. The following is produced in an iPlot window:

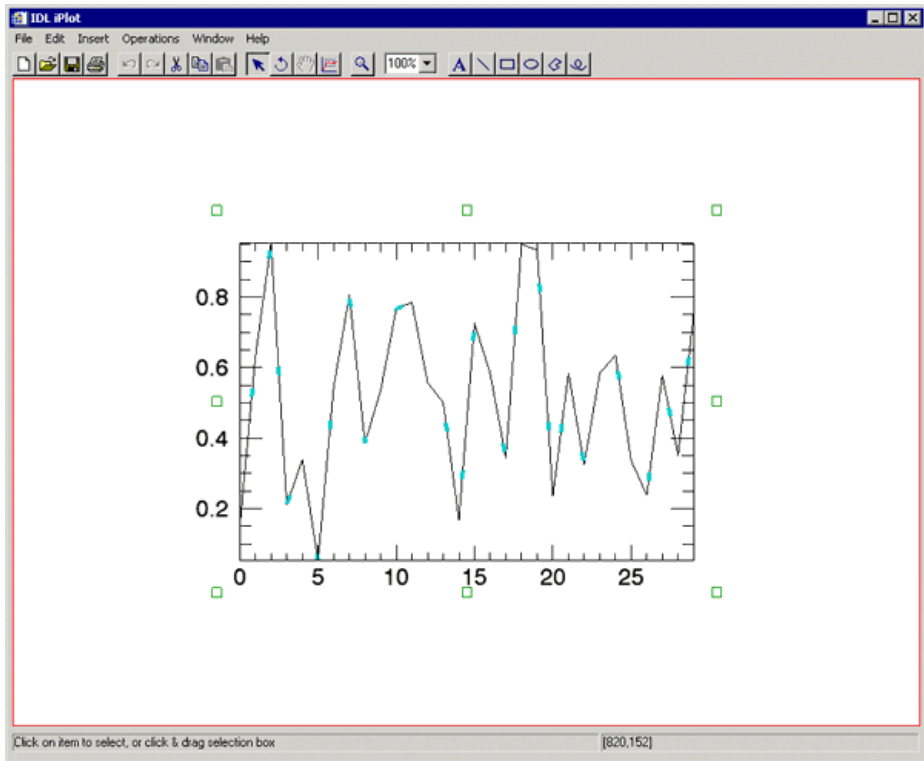

Figure 2-11: Reading Parameter Data in at the IDL Command Line

---

**Note**

See [Chapter 6, “Importing and Writing Data into Variables”](#) in the *Using IDL* manual for more information on Command Line data access.

---

# Exporting Data

Data of many common file formats can be exported by IDL iTools. File formats that are exportable are:

- ASCII text
- Binary data
- Encapsulated Postscript (EPS)
- Graphics Interchange Format (GIF)
- iTools State
- Joint Photographic Experts Group (JPG)
- JPEG2000
- Macintosh PICT
- Portable Network Graphics (PNG)
- Tag Image File Format (TIFF)
- Windows Bitmap (BMP)
- Windows Enhanced Metafile (WMF)

You can export data from an iTool to a data file or back to the current IDL session:

- [“Exporting Data to a File”](#) on page 45
- [“Exporting Data to the IDL Session”](#) on page 48

These methods are discussed next.

## Exporting Data to a File

You can export the contents of an entire iTool window into a single image or data file using the IDL Data Export Wizard.

For example, to export a file:

1. Select **File** → **Export**. The **IDL Data Export Wizard** appears.



*Figure 2-12: The IDL Data Export Wizard, Showing Step 1 of 3*

2. The first step asks you to choose to export the data to either a file or an IDL variable. Select **To a File** and then **Next**.

---

### Note

For more information on exporting data to an IDL variable, see the following section, [“Exporting Data to the IDL Session”](#) on page 48.

---

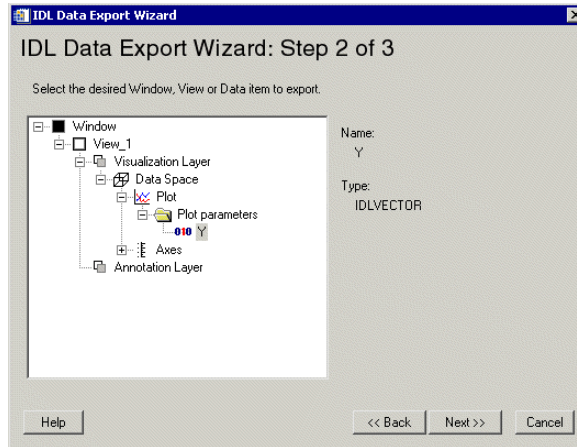

Figure 2-13: The IDL Data Export Wizard, Showing Step 2 of 3

3. From the next screen, select the data which you wish to export. Notice that only the Window level or View level can be exported. Click **Next**.

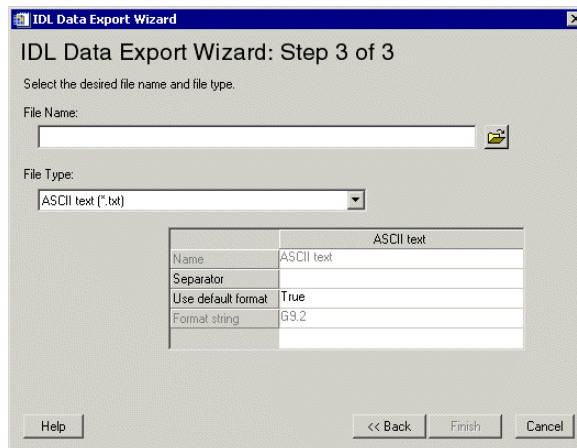

Figure 2-14: The IDL Data Export Wizard, Showing Step 3 of 3

4. You are now prompted for selection of the destination and file type. After entering a desired filename, extension, and destination, click **Finish**. The file is then exported.

## Exporting Data to the IDL Session

You can export data from an iTool into a single variable using the IDL Data Export Wizard.

For example, to export data to an IDL variable:

1. Select **File** → **Export**. The **IDL Data Export Wizard** appears.

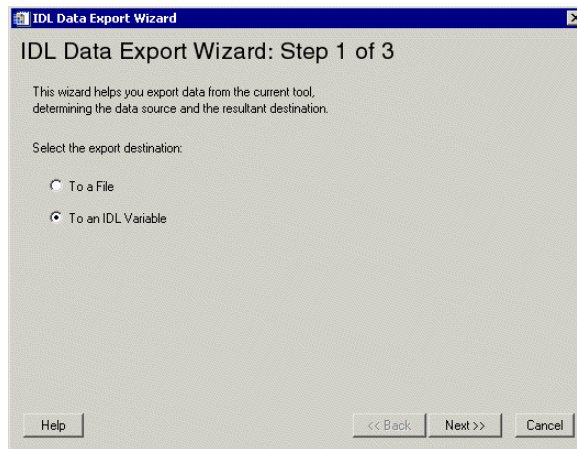

*Figure 2-15: The IDL Data Export Wizard, Exporting a Variable Step 1 of 3*



## 2. Select To an IDL Variable.

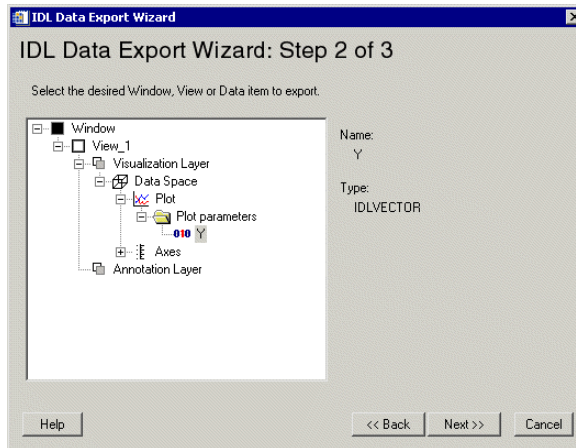

Figure 2-16: The IDL Data Export Wizard, Exporting a Variable Step 2 of 3

3. From the next screen, select the data that you wish to export. Notice that only data items can be exported as variables. Click **Next**.

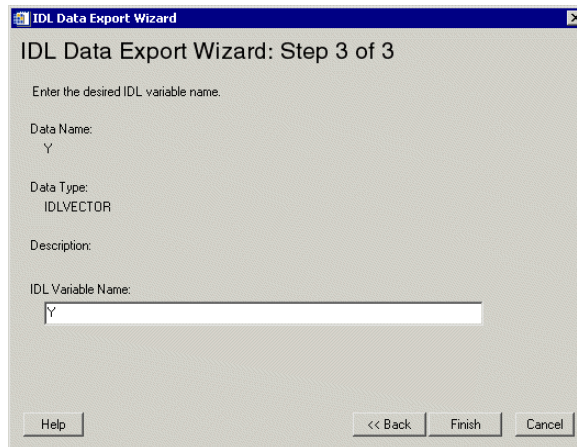

Figure 2-17: The IDL Data Export Wizard, Exporting a Variable Step 3 of 3

4. The final screen and step allow you to name your variable as you wish. A default name also appears as representative of the data item. Name your variable and click **Finish**.
5. The variable will now appear in the IDL Variable Watch window.

## Exporting via Context Menu

An alternate way to export a variable to IDL is to select the variable within the Visualization browser and right-click to choose **Export to IDL**. For more information on the Visualization browser, see [Appendix D, “Visualization Properties”](#).



# Chapter 3

# Visualizations

This chapter describes how working with visualizations within the iTool.

---

|  |    |   |    |
|--|----|---|----|
| <a href="#">About Visualizations</a> .....                 | 52 | <a href="#">Inserting Visualizations</a> .....          | 54 |
| <a href="#">Visualization Creation Methods</a> .....       | 53 | <a href="#">Modifying Existing Visualizations</a> ..... | 56 |
| <a href="#">Creating Visualizations Automatically</a> .... | 53 | <a href="#">Exporting Visualizations</a> .....          | 58 |

# About Visualizations

A *visualization* is a graphical representation of data that has been imported into the iTool Data Manager. This might mean a plot, image, or surface just to name a few. Visualizations can be created in any iTool window either automatically or manually. Visualizations can also be modified and exported. These topics are all discussed in [this chapter](#).

When data is imported into the IDL iTools system, it resides in the Data Manager. The Data Manager provides a convenient interface within which you can organize and manage data. For more information on importing and exporting data in an iTool and the use of the Data Manager, see [Chapter 2, “Importing and Exporting Data”](#).

This chapter deals with the process of visualizing data that is already imported into an iTool. Visualizations can be created automatically at the IDL Command Line or can be inserted manually within an existing tool window. Once created, visualizations contain parameters which can be modified in various ways. Visualizations can also be exported from an iTool. These topics are all discussed in detail in this chapter.

# Visualization Creation Methods

Visualizations can be created either automatically or manually. The following sections discuss automatic and manual creation methods.

## Creating Visualizations Automatically

Visualizations can be created automatically in the following ways:

- By specifying some data when creating an iTool at the IDL Command Line. For example:

```
myPlotData = RANDOMU(seed, 30)
iPlot, myPlotData
```

These statements will create a new data item in the iTool Data Manager and create a new iPlot tool that visualizes the data in a line plot.

- By opening a file in an existing iTool, either by selecting **File** → **Open** or using the Data Import Wizard (**File** → **Import...**).
- By using the Data Import Wizard (**File** → **Import...**) to import a variable from the IDL Session.

Both the Data Import Wizard and the process of using **File** → **Open** are described in detail in [Chapter 2, “Importing and Exporting Data”](#).

---

### Note

Certain data types (such as binary or ASCII) may require you to supply IDL with further information before they can be visualized. For more information about reading certain data types into iTools, see [“Importing Data from a File”](#) in Chapter 2.

---

## Inserting Visualizations

If you already have the necessary data in the iTool Data Manager, you can manually create a visualization in your iTool. This is done from your desired iTool window by selecting **Insert** → **Visualization**.

To access data using **Insert** → **Visualization** from your tool:

1. Start an iTool.
2. Select **Insert** → **Visualization**. The **Insert Visualization** Dialog appears.

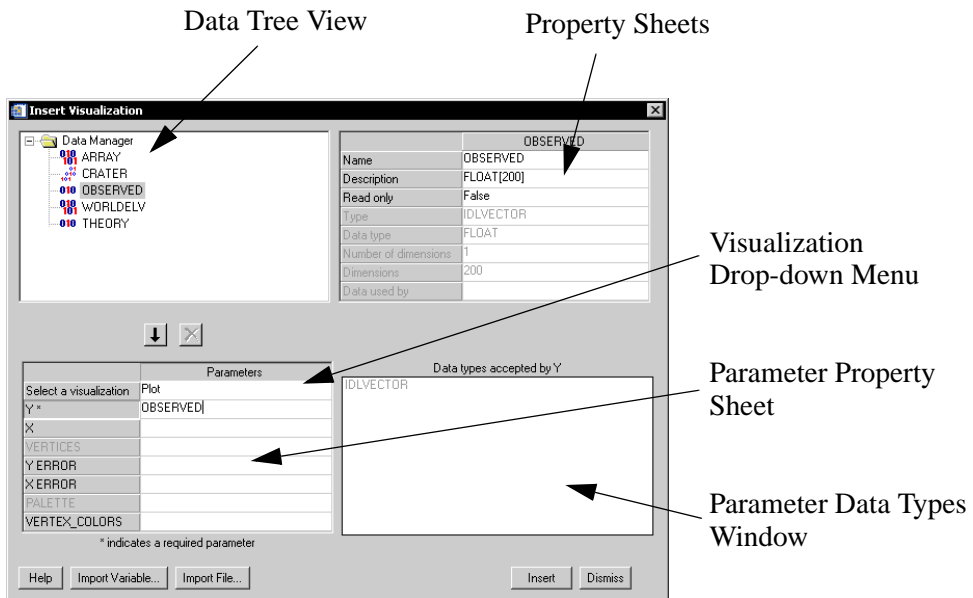

Figure 3-1: Insert Visualization Dialog With Image Visualization Type Selected

The **Insert Visualization** dialog contains the following items:

- **Data Tree View** — this tree contains any imported data and/or variables available for visualization in the Data Manager.
- **Data Properties** — this area, to the right of the Data Tree View, shows the properties of any selected Data Tree elements.
- **Select a Visualization Drop-down Menu** — this menu allows you to select the visualization type to use with the selected data.

- **Parameter Property Sheet**— these are the input parameters for the visualization type selected in the Visualization Type Drop-down Menu. These input variables will change per visualization type.
  - **Parameter Data Types Window** — this window to the right of the parameters table shows the properties of the selected parameter.
  - **Help** — this button will invoke the help system.
  - **Import Variable** — gives you the ability to select a variable to import into the Data Manager. For more information on importing a variable into your Data Manager, see [“Importing Data from the IDL Session”](#) on page 41.
  - **Import File** — gives you the ability to select data from a file to import into the Data Manager. For more information on importing a file into your Data Manager, see [“Importing Data from a File”](#) on page 34.
  - **Insert Button** — this button will insert the specified visualization into the current iTool. Insert is only active if data is associated with all required parameters.
  - **Dismiss** — this button will dismiss the dialog.
3. Select the visualization type from the visualization type drop-down menu.
  4. Next, assign data in the dialog to the parameters of the visualization being inserted.
  5. Now click **Insert** to finish inserting the visualization.

# Modifying Existing Visualizations

Once you have created your visualization, you can modify it as you wish. Use the Parameter Editor to modify parameter data.

## The Parameter Editor

The Parameter Editor is very similar to the Insert Visualization dialog. It shows the data tree view and parameter property sheet and parameter data types window.

If you have already created a visualization, you can change the data associated with one or more visualization parameters using the Parameter Editor. To display the Parameter Editor, select your visualization, then select **Edit** → **Parameters...**

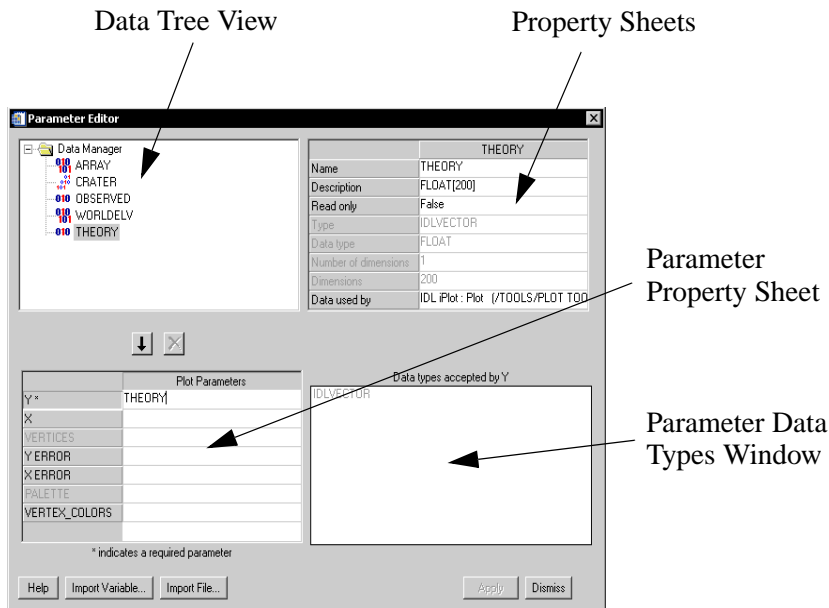

Figure 3-2: Parameter Editor

### Note

The Parameter Editor contains all of the fields shown in the Insert Visualization dialog, with the exception that you cannot change the visualization type of the selected visualization. See “[Inserting Visualizations](#)” on page 54 for details.



To associate data with a visualization's parameters using the Parameter Editor:

1. Select **Edit** → **Parameters**.
2. Do one of the following:
  - Select an item already in the Data Tree View.
  - Click **Import File** to import a file into the Data Tree View, and select the file.
  - Click **Import Variable** to import a variable into the Data Tree View, and select the variable.
3. Assign items to the appropriate input parameter and data item, then double-clicking or by selected the down arrow just below the Data Tree View.
4. Click **Apply** to apply your new changes or **Dismiss** to close the Parameter Editor.

---

**Note**

The **Apply** button will not be available unless all required parameters have been assigned within a visualization.

---

## Removing Data Associations

Once a visualization has been created, you can always remove associations within the parameter editor. Select the parameter in the parameter property sheet and click the X button between the data tree view and the parameter property sheet.

---

**Note**

If you remove a required parameter, you will not be able to apply your changes until you select a new data item for that parameter.

---

## Replacing Data Associations

To replace the data associated with a given parameter, select the parameter in the parameter property sheet, then select a new data item in the data tree. Double-click or click the down arrow button to replace the data associated with the selected parameter.

# Exporting Visualizations

Any iTool visualization can be saved. In order to save your visualization, select **File** → **Save As...** and then name the file. The file will automatically be assigned the extension `.isv`.

## Exporting to a File

You can export data from an iTool to a data file or back to the current IDL session. For more information on exporting to a file, see [“Exporting Data”](#) in Chapter 2.



# Chapter 4

# Manipulating the Display

This chapter describes the following common tasks that can be performed with all of the IDL Intelligent Tools:

---

|  |    |                                      |    |
|--|----|--------------------------------------|----|
| <a href="#">Introduction</a> .....         | 60 | <a href="#">Scaling</a> .....        | 65 |
| <a href="#">Selection of Objects</a> ..... | 61 | <a href="#">Zooming</a> .....        | 70 |
| <a href="#">Undo/Redo</a> .....            | 62 | <a href="#">View Panning</a> .....   | 72 |
| <a href="#">Adding a Data Space</a> .....  | 63 | <a href="#">Window Layouts</a> ..... | 73 |
| <a href="#">Translation</a> .....          | 64 |                                      |    |

# Introduction

The Standard IDL *iTools* supplied in the IDL distribution comprise six distinct tools: *iImage*, *iPlot*, *iSurface*, *iContour*, *iVolume*, and *iMap*. Each tool performs a specific set of tasks related to the type of data it is designed to use. In addition to these specific tasks, all six tools have a number of manipulation tasks in common. This chapter describes only these common display manipulation tasks; for information about specific tasks performed by the individual *iTools*, refer to the chapters describing those tools.

---

**Note**

This chapter describes manipulation tasks related only to the Standard IDL *iTools*, those *iTools* supplied in the IDL distribution. Other *iTools* written by users and third-party developers share a common interface with the RSI *iTools* because the *iTools* framework is used to create all *iTools*. However, the specific functionality of such *iTools* may be different from the functionality of the *iTools* described here.

---

# Selection of Objects

iTool elements such as axes and annotations have objects associated with them. These objects have their own associated *properties* — such as color, line style, size, and so on. There are two ways to select objects in IDL iTools:

- With the Select arrow
- From the Visualization Browser

To select an object or group of objects with the Select arrow:

1. If necessary, click the Select button  on the toolbar to enter Select mode.
2. Position the arrow mouse pointer over the object and click. A selection box appears around the object.
3. To select additional objects, hold down the SHIFT key while clicking them.

To select an object or group of objects from the Visualization Browser:

1. Select **Window** → **Visualization Browser**.
2. Click the name of the object in the Visualization Browser list. A selection box or selection highlight appears on that object in the iTool window.
3. To select additional objects, hold down the Shift key while selecting the names of additional objects in the Visualization Browser list.

## Select All

**Select All** selects all objects (visualizations, annotations, legends, etc.) displayed in the iTool window.

To select all objects:

1. Select **Edit** → **Select All**. All displayed objects are selected.
2. CTRL + click to deselect any objects that you do not want to include.

# Undo/Redo

Any action performed in an iTool window can be undone or redone. The Undo and Redo mechanism provides a useful way of retracing and repeating steps that have been performed in the iTool window.

---

**Note**

Operations which cannot be undone are Open, Save, Export, Export variable, Print, Exit, and window moving and resizing.

---

To undo the most recent action, do one of the following:

- Select **Edit** → **Undo**
- Click 

To undo multiple actions, simply repeat these commands. When no more actions remain to be undone, the Undo menu item or toolbar button is no longer active.

To repeat actions that have been undone, do one of the following:

- Select **Edit** → **Redo**
- Click 

---

**Tip**

Look at the text following the Undo or Redo menu item, or hover the mouse pointer over the Undo or Redo button on the toolbar to display the tooltip, to identify the action that will be undone or redone.

---

## Adding a Data Space

The data space is the area within your visualization window where imported data appears. A data space is added automatically when data is visualized directly into an iTool window. However, if you desire to add a data space manually to any of the iTools, you can select **Insert** → **Data Space** from the iTool window.

# Translation

**Translation** moves an object or group of objects in a specified direction. When an object is selected, a bounding box appears around the object.

To translate a selected object to another location:

1. Position the pointer inside the bounding box. The mouse pointer changes to the translation pointer  $\oplus$ .
2. Drag in the desired direction. The entire object moves to the new location.

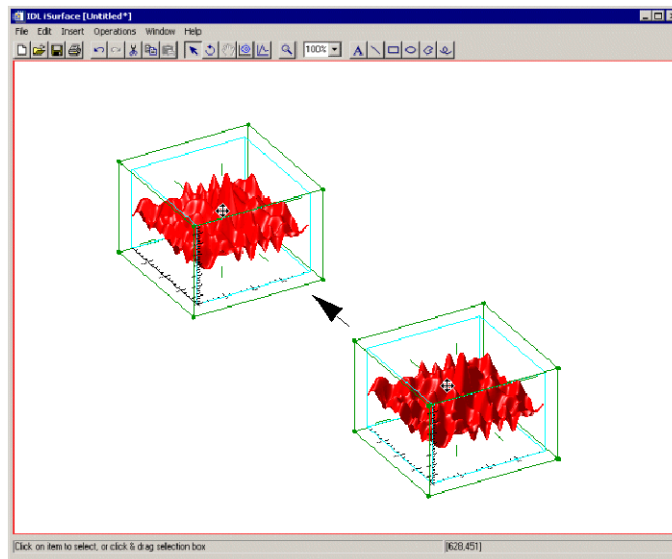

Figure 4-1: Translating Objects

---

**Note**

For information on creating a surface visualization which you can translate such as the one shown in the previous figure, see [Chapter 11, “Working with Surfaces”](#).

---

**Note**

An axis (or axes) will behave differently during translation if any other object is also selected.

---



# Scaling

Two types of scaling are possible: constrained scaling and unconstrained scaling.

## Constrained Scaling

Constrained scaling permits scaling of only one dimension while preserving the other dimensions.

### Constrained Scaling of 2-D Objects

To scale one dimension of a 2-D object, click on the object so that eight small selection-boxes appear at each corner of the object and also midway along each side of the object. Then position the mouse onto one of these boxes so that the mouse pointer changes to a four-headed arrow pointer (see the following figure). Drag the mouse in the desired direction to scale the object in the selected dimension.

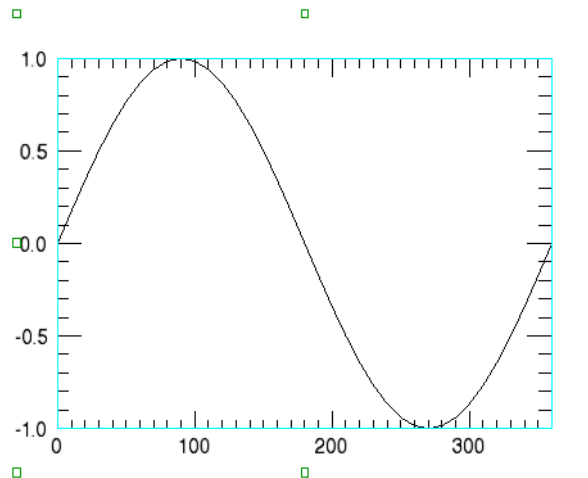

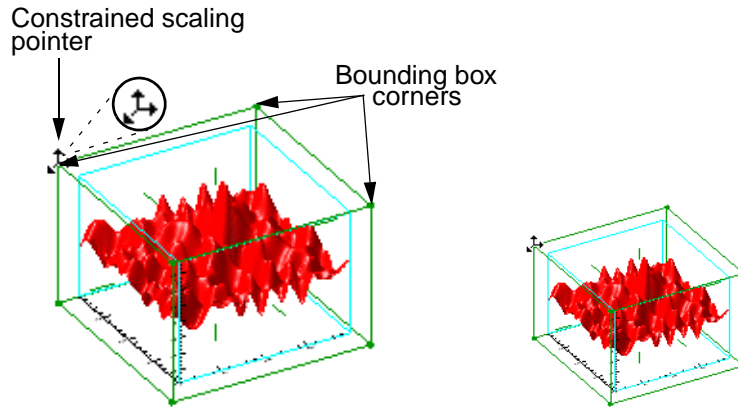

Figure 4-2: Resizing a 2-D Plot

### Constrained Scaling of 3-D Objects

Two types of constrained scaling are available for 3-D objects: multiple-axis scaling and single-axis scaling.

The multiple-axis scaling mouse pointer for 3-D objects is a three-headed arrow  displayed when the mouse pointer is positioned over a corner of a 3-D object's data space. Dragging the constrained scaling pointer scales the object a fixed distance along all axes in the direction of the drag.



*Figure 4-3: Constrained Scaling*

The single-axis scaling pointer for 3-D objects is a two-headed arrow  $\updownarrow$ , displayed when the pointer is positioned over an axis “whisker” in a 3-D image. Dragging an axis “whisker” scales the object only in the direction of the arrows.

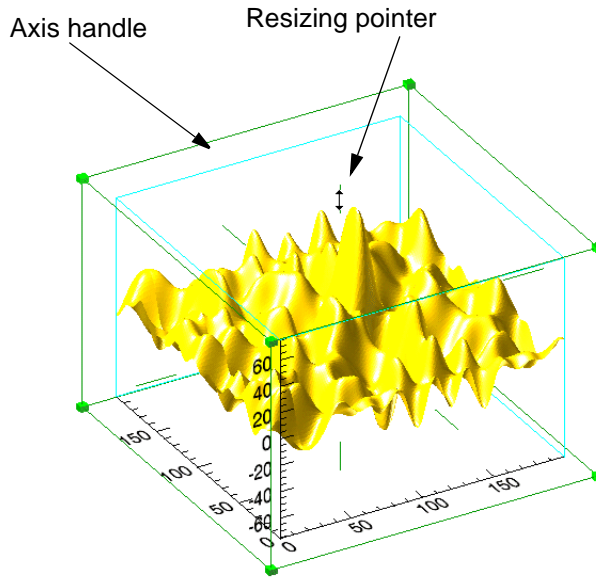

Figure 4-4: Resizing a 3-D Surface

## Unconstrained Scaling

Unconstrained scaling allows you to scale all dimensions of an object at once from any point within the object. Unconstrained scaling is different for 2-D and 3-D objects.

## Unconstrained Scaling of 2-D Objects

Unconstrained scaling of 2-D objects occurs when a corner of the data set bounding box is dragged. The mouse pointer changes to an unconstrained scaling pointer  $\times$ , and the object is scaled in the direction of the drag.

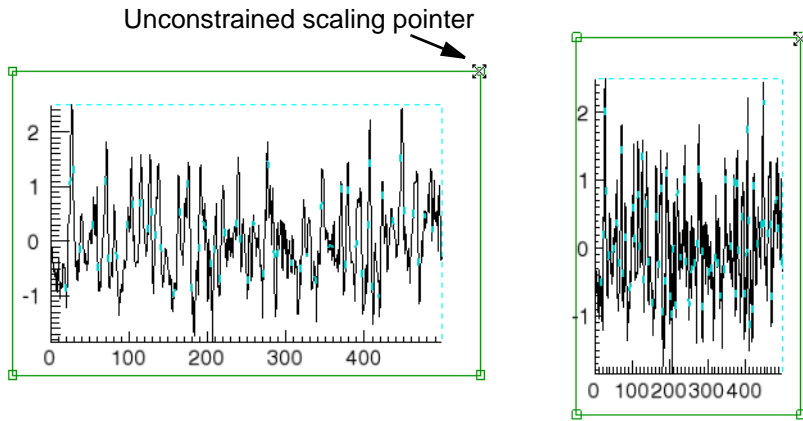

*Figure 4-5: Unconstrained Scaling of a 2-D Plot*

## Unconstrained Scaling of 3-D Objects

Unconstrained scaling of 3-D objects occurs when a single side of the data set bounding box is dragged. The mouse pointer changes to an unconstrained scaling pointer  $\times$ , and the object is scaled along the dimensions of the selected side.

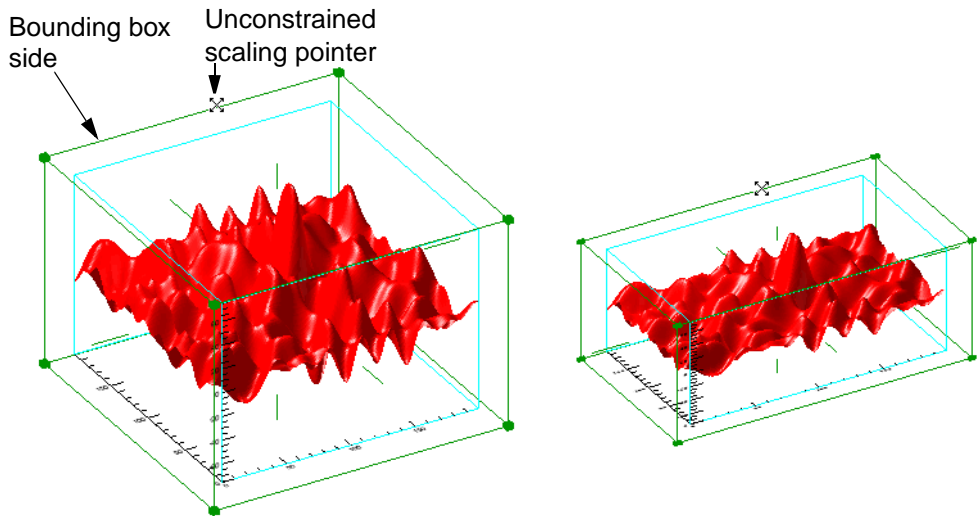

Figure 4-6: Unconstrained Scaling of a 3-D Surface

# Zooming

Two types of zooming are available in all iTools:

- **Canvas Zoom** changes the magnification of the entire display canvas (everything in the iTool window). If the display canvas is larger than the iTool window, scroll bars appear.
- **View Zoom** changes the magnification applied to the selected view. If the size of the view is larger than the visible portion of the view (that is, if the view zoom is greater than 100%), the *view pan* manipulator becomes active, allowing you to move different portions of the view into the visible area.

## Canvas Zoom

**Canvas Zoom** increases or decreases magnification of the entire iTool window without moving the observer's "eye."



To zoom in or out with Canvas Zoom:

1. Select **Window** → **Canvas Zoom** and select a percentage from the list.
  - To increase magnification, choose a percentage greater than **100%**.
  - To decrease magnification, choose a percentage less than **100%**.
2. Select **100%** to return to the default magnification.

## View Zoom

**View Zoom** increases or decreases magnification of items in the currently selected view in an iTool window. This is similar to moving the observer's "eye" closer to or farther away from the objects in the view. You can change the view zoom using the view zoom button or by using the view zoom pull-down menu.

To use the view zoom button:

1. Click Zoom  on the toolbar to enter Zoom mode.
2. Position the mouse pointer on the viewplane. The pointer changes to a zoom pointer .
3. Do either of the following:
  - Drag the zoom pointer toward the top of the iTool window to enlarge the display

- Drag the zoom pointer toward the bottom of the iTool window to make the display smaller
4. Click on the arrow Select button to leave Zoom mode and return to Select mode. The mouse pointer changes to an arrow pointer. In Select mode, dragging the arrow pointer positions the zoomed image.

The view zoom combobox is located just to the right of the view zoom manipulator button on the toolbar and always reports the zoom factor of the currently selected view. You can also use this combobox to set a requested zoom factor for the currently selected view by simply using the pull-down menu to select a value.

# View Panning

The view pan button appears on the iTool's toolbar as a hand (shown depressed below) and allows panning within an iTool view by clicking and dragging the mouse.



*Figure 4-7: View Pan Selected*

Notice that panning will only be possible if the iTool view is not completely within the window, or the iTool view is larger than viewable area of the window.



# Window Layouts

You can change the minimum size of the canvas displayed in the iTool window, display multiple views in the iTool window, or select a preset arrangement of views, with the Window Layout dialog.

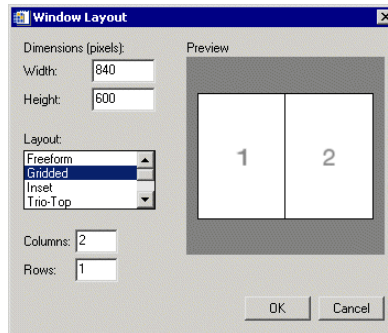

Figure 4-8: Window Layout Tool

## Note

If you are in Freeform mode, canvas size can also be changed interactively by dragging the corners or sides of the iTool window.

To change the minimum size of the canvas displayed in the iTool window:

1. Select **Window** → **Layout**.
2. Edit the pixel values in the **Width** and **Height** text boxes (Default = Width 512, Height 384). A preview of the shape of the new canvas size is displayed in the Preview window.
3. Click **OK** to apply the changes or **Cancel** to close the window without applying changes.

To change the number of views displayed:

1. Select **Window** → **Layout**.
2. Select **Gridded** from the Layout list.
3. Edit the number of columns and rows in the Grid text boxes (Default = 1 by 1).

- Click **OK** to apply the changes or **Cancel** to close the window without applying changes.

To select a preset arrangement of views:

- Select **Window** → **Layout**.
- Select from the following arrangements in the Layout list:

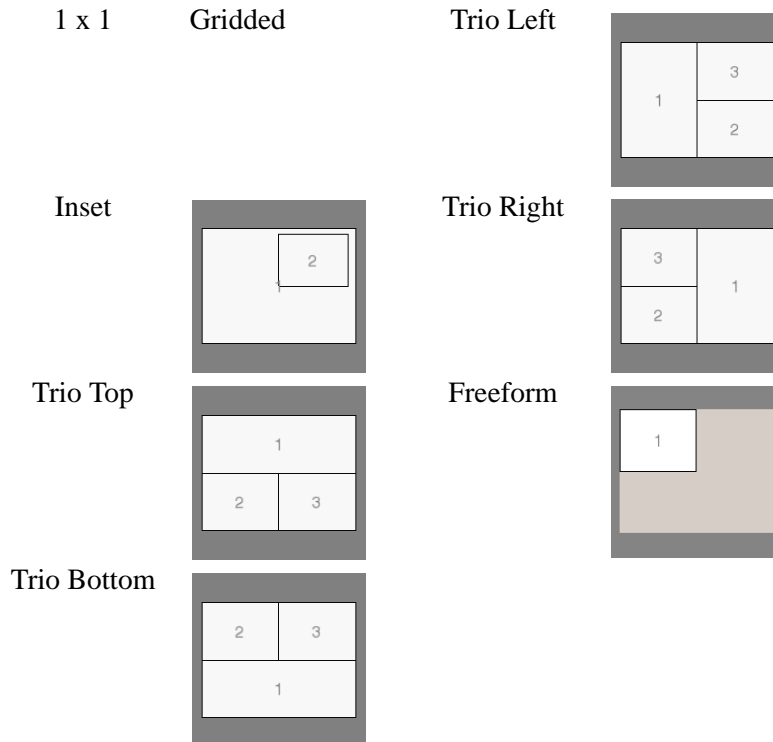

- Click **OK** to apply the changes, or **Cancel** to close the window without applying changes.



# Chapter 5

# Adding Annotations

This chapter describes the following common tasks that can be performed with all of the IDL Intelligent Tools:

---

|                                    |    |                                       |    |
|------------------------------------|----|---------------------------------------|----|
| <a href="#">Introduction</a> ..... | 76 | <a href="#">Annotations</a> .....     | 79 |
| <a href="#">Legends</a> .....      | 77 | <a href="#">Additional Axes</a> ..... | 84 |

# Introduction

The six Standard IDL iTools supplied in the IDL distribution (iImage, iPlot, iSurface, iContour, iVolume, and iMap) each possess common annotation capabilities. This chapter describes this common annotation functionality and how it can be used.

---

**Note**

This chapter describes Annotation functionality for only the Standard IDL iTools, those iTools supplied in the IDL distribution. Other iTools written by users and third-party developers share a common interface with the RSI iTools because the iTools framework is used to create all iTools. However, the specific functionality of such iTools may be different from the functionality of the iTools described here.

---

# Legends

Legends identify the visualizations displayed in the iTool window. For example, a legend displayed in an iPlot window can include a description of each plot line in a plot. Or a legend can be displayed in an iSurface window to identify surfaces and contour levels displayed on those surfaces.

To insert a legend for a surface or contour:

1. Select specific items to include in the legend, or click in an empty area of the iSurface window dataspace to select the dataspace and include all items in the legend.
2. Select **Insert** → **New Legend**.

To add to a legend:

1. Select the visualization item or items to add to the legend.
2. If there are multiple legends, add the desired legend to the selection by shift-clicking the legend border.
3. Select **Insert** → **Legend Item**.

---

**Note**

Only a single legend item may exist for a given visualization. If you are inserting multiple visualization items into an existing legend, only legend items for those visualizations not already represented will be added to the legend.

---

Each legend entry consists of a sample and a label. For example, in [Figure 5-1](#), the sample for the first entry is an unbroken line of thickness 1, and the label is Noisy Sine Plot. The sample for the second is a broken blue line of thickness 2, and the label is Clean Sine Plot.

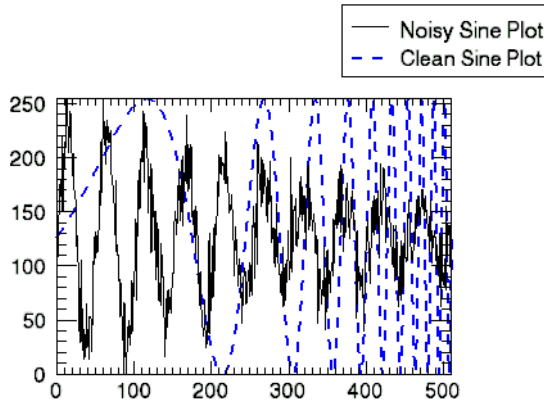

*Figure 5-1: Legend for Two Plot Lines*

---

**Tip**

To alter your legend's properties such as in the example shown previously, display the property sheet. To do this, double-click the border of the legend box.

---

# Annotations

The following types of annotations can be added to iTool visualizations:

| Annotation Type | Description   |
|-----------------|---|
| Text            | Single lines or multiple lines of text can be added to a visualization to provide a label or description.     |
| Line            | Straight line annotations can be added to a visualization to link labels to objects or to identify an object. |
| Rectangle       | Rectangular annotations can be added to a visualization to identify rectangular areas.                        |
| Oval            | Oval annotations can be added to a visualization to identify circular areas.                                  |
| Polygon         | Polygon annotations can be added to a visualization to identify areas bounded by a multi-sided polygon.       |
| Freehand        | Freehand annotations can be added to a visualization to identify an area.                                     |

*Table 5-1: Types of Annotations*

## Note

Annotations are 2-D in nature and are defined in their own data space. They are most useful for adding notes to a data visualization for which the orientation has been finalized.

## Text Annotations

To add a text annotation:

1. Click the Text Annotation button  on the toolbar.
2. Click anywhere on the canvas. A text insertion bar appears where you click.
3. Type the annotation text.
  - To add a new line, press **Ctrl + Enter**
  - To add superscript characters, press **Ctrl + U**

- To add subscript characters, press **Ctrl + D**
- To return to normal characters, press **Ctrl + N**



**Note**

For information on how to embed these and other formatting commands from the Text Annotation property sheet, refer to “Text Annotation Properties” on page 481.

4. Press Enter. A bounding box appears around the annotation text.
  - To position the annotation, position the mouse pointer within the bounding box so that it changes to a translation pointer . Click and drag the annotation to the desired location.
  - To display and modify text annotation properties such as font, text color and transparency, double-click the bounding box or inside the bounding box.

## Line Annotations





To add a line annotation:

1. Click the Line Annotation button  on the toolbar.
2. Click in an empty part of the canvas and, without releasing the mouse button, drag to draw a line of the desired length.
  - To constrain in the direction that you are drawing, hold down the **Shift** key while drawing
  - To draw the line from the center, hold down the **Ctrl** key while drawing
3. Release the mouse button. Selection handles appear at both ends of the line annotation.
  - To position the line annotation, position the mouse pointer over the selected line so that it changes to a translation pointer . Click and drag the annotation to the desired location.
  - To resize the line annotation, position the mouse pointer over the selection handle at one end of the line so that it changes to a resize pointer . Click and drag the selection handle to obtain the desired line length.
  - To display and modify line annotation properties such as line thickness and arrow style, double-click the annotation.



## Rectangle Annotations



To add a rectangle annotation:

1. Click the Rectangle Annotation button  on the toolbar.
2. Click in an empty part of the canvas and, without releasing the mouse button, drag to draw a rectangle of the desired size.
  - To constrain the rectangle to a square, hold down the **Shift** key while drawing
  - To draw the rectangle from the center, hold down the **Ctrl** key while drawing
3. Release the mouse button. Selection handles appear at the corners and sides of the rectangle annotation.
  - To position the rectangle annotation, position the mouse pointer inside the selected rectangle so that it changes to a translation pointer . Click and drag the annotation to the desired location.
  - To resize the rectangle annotation, position the mouse pointer over the selection handle on one side of the rectangle so that it changes to a resize pointer . Click and drag the selection handle to obtain the desired shape.
  - To scale the rectangle annotation, position the mouse pointer over the selection handle at one corner of the rectangle so that it changes to an unconstrained scaling pointer . Click and drag the selection handle to obtain the desired scaling.
  - To display and modify rectangle annotation properties such as background color and transparency, double-click the annotation.

## Oval Annotations

To add an oval annotation:

1. Click the Oval Annotation button  on the toolbar.
2. Click in an empty part of the canvas and, without releasing the mouse button, drag to draw a circular annotation of the desired size.
  - To constrain the oval to a circle, hold down the **Shift** key while drawing.
  - To draw the oval from the center, hold down the **Ctrl** key while drawing.
3. Release the mouse button. Selection handles appear at the corners and sides of the oval annotation.

- To position the oval annotation, position the mouse pointer inside the selected oval so that it changes to a translation pointer . Click and drag the annotation to the desired location.
- To resize the oval annotation, position the mouse pointer over the selection handle on one side of the oval so that it changes to a resize pointer . Click and drag the selection handle to obtain the desired shape.
- To scale the oval annotation, position the mouse pointer over the selection handle at one corner of the oval so that it changes to an unconstrained scaling pointer . Click and drag the selection handle to obtain the desired scaling.
- To display and modify oval annotation properties such as background color and transparency, double-click the annotation.

## Polygon Annotations

To add a polygon annotation:



1. Click the Polygon Annotation button  on the toolbar.
2. Click in an empty part of the canvas to specify the first point of the polygon.
3. Click again to specify the second point of the polygon. A line is drawn to connect the first and second points.
4. Click to specify the third and each consecutive point of the polygon. Lines are drawn to connect each subsequent point, forming a multi-sided shape.

---

### Tip

To remove the last point, press the Esc key.

---





5. Double-click to specify the last point of the polygon. Selection boxes appear at the corners and sides of the newly-created annotation.
  - To position the polygon annotation, position the mouse pointer inside the selected polygon so that it changes to a translation pointer . Click and drag the annotation to the desired location.
  - To resize the polygon annotation, position the mouse pointer over the selection handle on one side of the polygon so that it changes to a resize pointer . Click and drag the selection handle to obtain the desired shape.
  - To scale the polygon annotation, position the mouse pointer over the selection handle at one corner of the polygon so that it changes to an

unconstrained scaling pointer . Click and drag the selection handle to obtain the desired scaling.

- To display and modify polygon annotation properties such as background color and transparency, double click the annotation.

## Freehand Annotations

To add a freehand annotation:

1. Click the Freehand Annotation button  in the toolbar.
2. Click in an empty part of the canvas and, without releasing the mouse button, drag to draw a freehand shape.
3. Release the mouse button. Selection handles appear at the corners and sides of the selected freehand annotation.
  - To position the freehand annotation, position the mouse pointer inside the selected freehand shape so that it changes to a translation pointer . Click and drag the annotation to the desired location.
  - To resize the freehand annotation, position the mouse pointer over the selection handle on one side of the freehand shape so that it changes to a resize pointer . Click and drag the selection handle to obtain the desired shape.
  - To scale the freehand annotation, position the mouse pointer over the selection handle at one corner of the freehand shape so that it changes to an unconstrained scaling pointer . Click and drag the selection handle to obtain the desired scaling.
  - To display and modify rectangle annotation properties such as background color and transparency, double-click the annotation.

# Additional Axes

By default, X, Y, and (for 3-D data spaces) Z axes are displayed in the iTool window. The display of these axes is controlled by property sheets for the axes container and for individual axes (see “[Axes](#)” on page 458). Additional X, Y or Z axes can be added to most data spaces to make it easier to identify characteristics.

To add an additional axis to your data space:

1. Select the data space.
2. Select **Insert** → **Axis**.
3. Choose from the following options:
  - X axis
  - Y axis
  - Z axis

Use the mouse to position the new axis, and double-click the axis to display the axis property sheet.

---

**Note**

For a 3-D visualization, you can use the **Shift + Ctrl** to translate an axis in the opposite direction. This will be shown in the Status message when an axis is selected for translation. You can also use the arrow keys to change axes placement direction.

---



## Chapter 6

# Property Sheets and Browsers

This chapter describes the following common tasks that can be performed with all of the IDL Intelligent Tools:

---

|   |    |   |    |
|---|----|---|----|
| <a href="#">Introduction</a> .....              | 86 | <a href="#">The Preferences Browser</a> ..... | 95 |
| <a href="#">Property Sheets</a> .....           | 87 | <a href="#">The Operations Browser</a> .....  | 93 |
| <a href="#">The Visualization Browser</a> ..... | 90 |   |    |

# Introduction

The six Standard IDL iTools supplied in the IDL distribution (iPlot, iSurface, iContour, iVolume, and iMap) each share several common property sheets and browsers. This chapter discusses those property sheets and browsers and their uses.

---

**Note**

This chapter describes only the Standard IDL iTools, those iTools supplied in the IDL distribution. Other iTools written by users and third-party developers share a common interface with the RSI iTools because the iTools framework is used to create all iTools. However, the specific functionality of such iTools may be different from the functionality of the RSI iTools described here.

---

# Property Sheets

Most iTool visualizations and operations have attributes or *properties* that can be modified to change their characteristics. These properties are organized into *property sheets* for each operation and visualization type. For example, the skin of a surface visualization has a gold color by default. To change this color, modify the surface color property in the surface visualization property sheet.

A property sheet consists of rows and columns. The left-most column identifies the properties, and the other column or columns identify the property values of one or more objects. A single property value can be selected at one time. When a single property value is clicked on, the associated property name appears indented. In the Style Editor and Macro Editor, multiple properties can be selected at a single time as shown in the following figure. Hold down the **Ctrl** key while left-clicking with the mouse to make nonadjacent selections, or hold down the **Shift** key to select an adjacent range of properties.

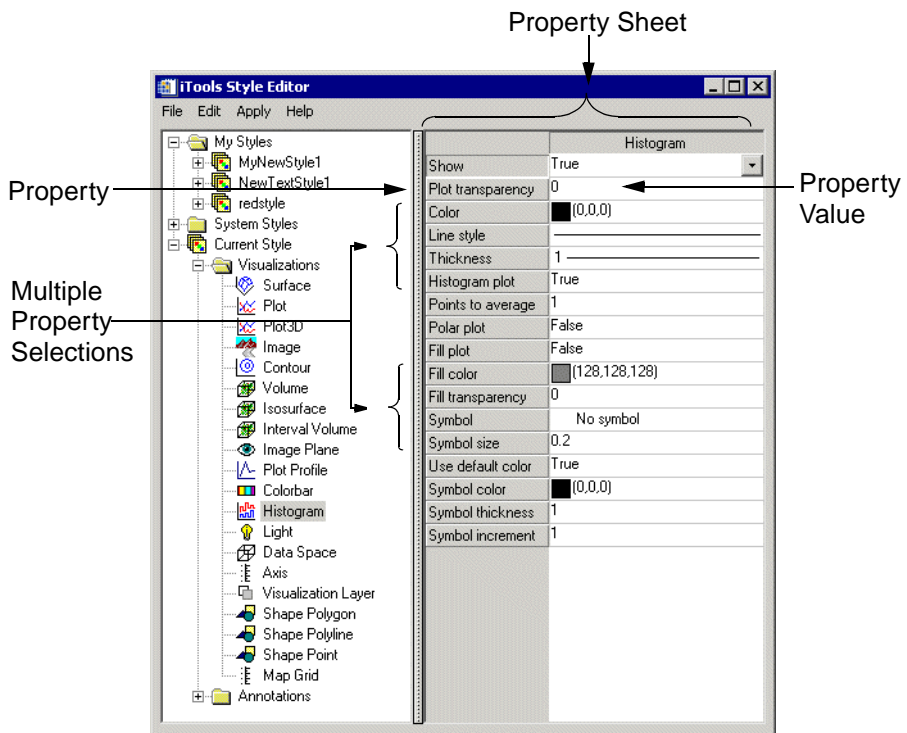

Figure 6-1: Property Sheet with Multiple Property Selections

## Visualization Property Sheets

Visualization property sheets can be displayed from the Visualization Browser or from the iTool window.

To display a visualization's property sheet from the Visualization Browser:

1. Select **Window** → **Visualization Browser**.
2. Select the name of the object in the Visualization Browser list. The object's properties are displayed in the right-hand pane of the Visualization Browser window (the small arrows at the top-left of the Browser window will allow you to display both panes).

To display a visualization's property sheet from the iTool window:

1. Click to select the object in the iTool window.
2. Do one of the following to display the property sheet for the selected visualization:
  - Double-click the visualization in the iTool window
  - Select **Edit** → **Properties**
  - Right-click to display the Context Menu, and select the **Properties** menu item

---

### Note

For detailed information on Visualization Browser properties, see [Appendix D, "Visualization Properties"](#).

---

## Operations Property Sheets

Operations property sheets can only be displayed from the Operations Browser. To display an operations property sheet:

1. Select **Operations** → **Operations Browser**.
2. Select the name of the operation in the Operations Browser list. The operation properties are displayed in the right-hand pane of the Operations Browser window (the small arrows at the top-left of the Browser window will allow you to display both panes).



**Note**

---

For detailed information on Operations Browser properties, see [Appendix C, “Operations Properties”](#).

---

# The Visualization Browser

The Visualization Browser provides access to *visualizations* (objects displayed in the iTool window) and the properties of those visualizations. When the Visualization Browser is displayed, you can select graphical objects from a nested list and display the property sheets for those objects. For example, if a surface visualization is displayed and you would like to change the appearance of the X axis in that visualization, you can select the axis in the Visualization Browser (Figure 6-2), display the property sheet for that axis (Figure 6-3), and modify the properties to change the appearance of the axis.

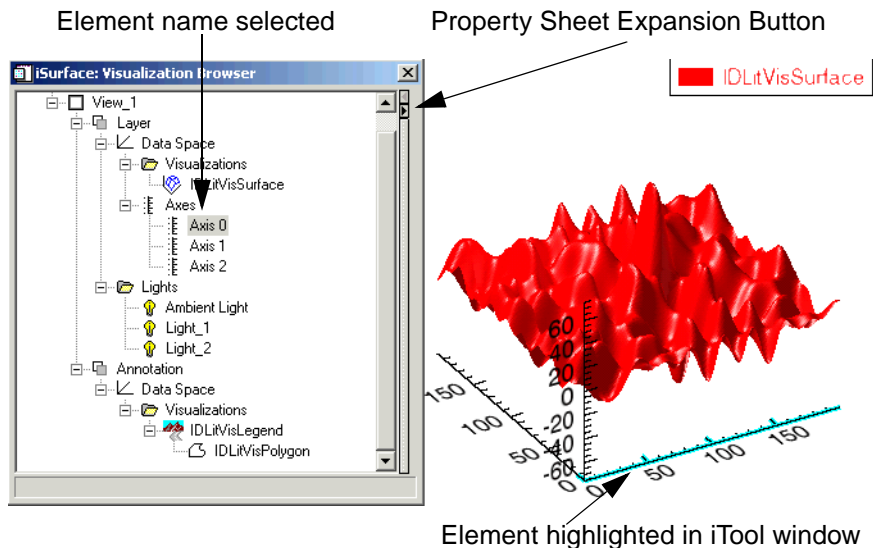



Figure 6-2: Visualization Browser with Axis 0 Selected

To select an object with the visualization browser:

1. Select **Window** → **Visualization Browser**.
2. Select the name of the object in the list. The element is highlighted in the iTool window.
  - To expand a list item, click the + icon 
  - To collapse an expanded list item, click the - icon 

- To display the property sheet for the object, click the expansion button to the right of the list or double-click the property.

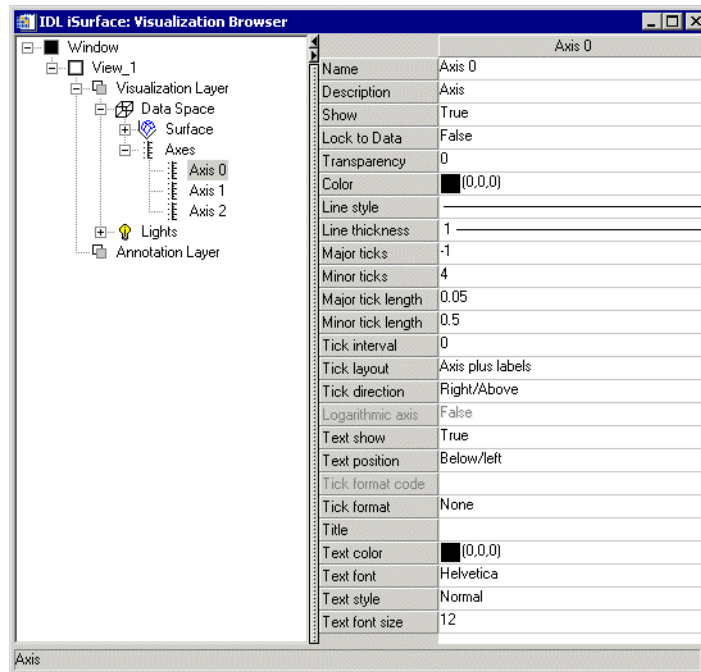



Figure 6-3: Visualization Browser with Property Sheet Displayed

- To change a property setting, click in the settings column.
  - If a drop-down button  appears in the settings column, click the button to choose a new setting from the list of options, activate a slider to change the setting value, display a selection dialog or list, or display an Edit button providing access to a user-defined property control.
  - If the text is editable, edit the text to change the setting.

See [Appendix B, “Property Controls”](#) for a detailed description of the types of property settings included in property sheets.

- Click the Close button  to close the Visualization Browser.

**Note**

---

Properties of standard graphical objects are described in detail in [Appendix D, “Visualization Properties”](#) and in the “IDL Commands” chapter of the *IDL Reference Guide*.

---

# The Operations Browser

The Operations Browser provides a quick way to display and modify the properties for a given iTool *operation* (task performed on iTool data) before that operation is performed. For example, to display the properties of the Convolution filter, select the name of the filter in the left pane of the Operations Browser (see [Figure 6-4](#)), and modify the Scale factor property value in the right pane to change the default scale factor for convolution.

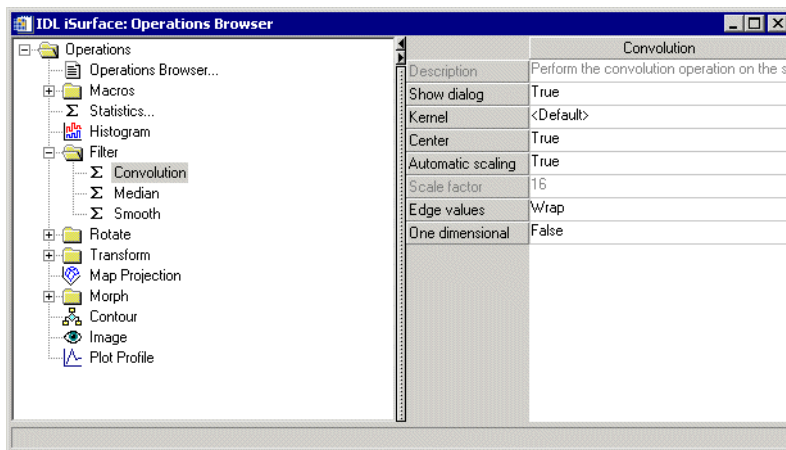



Figure 6-4: Operations Browser with Convolution Filter Properties Displayed

The Operations Browser displays a nested list of operations available in the current iTool in the left pane, and a property sheet for the currently selected operation in the right pane.

- To expand a list item, click the + icon
- To collapse an expanded list item, click the - icon

To change the properties of an operation from the Operations Browser:

1. Select **Operations** → **Operations Browser**.
2. Select the name of the operation in the list. A list of properties and the property settings appears in the right-hand pane of the Operations Browser window.
3. Locate the property you want to change in the list, and click in the settings column.

- If a drop-down button  appears in the settings column, click the button to choose a new setting from the list of options, activate a slider to change the setting value, display a selection dialog or list, or display an Edit button providing access to a user-defined property control.
- If the text is editable, edit the text to change the setting.

See [Appendix B, “Property Controls”](#) for a detailed description of the types of property settings included in property sheets.

4. Click the Close button  to close the Operations Browser.

---

**Note**

Properties of standard iTool operations are described in [Appendix C, “Operations Properties”](#) and in the “IDL Commands” chapter of the *IDL Reference Guide*.

---

# The Preferences Browser

The Preferences Browser provides a means of setting *preferences*, or default properties, for the general settings and file readers and writers used by all iTools. For example, if you prefer default drag quality to be low rather than high, you can change the default property for Default drag quality from **High** to **Low** in the Preferences Browser, as shown in [Figure 6-5](#).

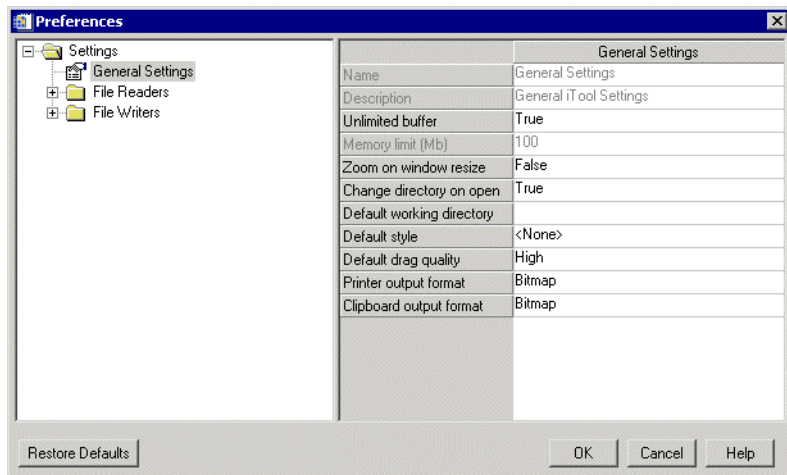

*Figure 6-5: Preferences Browser with Contour Projection Properties Displayed*



For more information on the property sheets displayed in the right-hand pane of the Preferences Browser, see [Appendix D, “Visualization Properties”](#).

The Preferences Browser displays a nested list of general preferences, file readers, and file writers available for all iTools in the left pane, and a property sheet for the currently selected item in the right pane.

- To expand a list item, click the + icon
- To collapse an expanded list item, click the - icon

To change the properties of a general setting, file reader, or file writer from the Preferences Browser:

1. Select **File** → **Preferences**.

2. Select the name of the general setting, file reader, or file writer in the list. A list of properties and the current property settings appears in the right-hand pane of the Preferences Browser window.
3. Locate the property you want to change in the list, and click in the settings column.
  - If a drop-down button  appears in the settings column, click the button to choose a new setting from the list of options, activate a slider to change the setting value, display a selection dialog or list, or display an Edit button providing access to a user-defined property control.
  - If the text is editable, edit the text to change the setting.
4. Click the Close button  to close the Preferences Browser.

---

**Note**

Changes to preferences are saved between iTool sessions. When the **OK** button is clicked, preferences are saved in their current state.

---



## General Settings

The first option on the Preferences Browser is the General Settings option. Settings listed here will be applied to all iTools if altered. The properties listed here are:

| Property                  | Control Type: Values  |
|---------------------------|---|
| Unlimited Buffer          | <p><b>Boolean:</b> Set to determine undo/redo buffer size as limited or unlimited:</p> <ul style="list-style-type: none"> <li>• <b>True</b> (limited)</li> <li>• <b>False</b> (unlimited)</li> </ul> <p>Default = <b>True</b></p> |
| Zoom on Window Resize     | <p><b>Boolean:</b> Set to determine if iTool data resizes upon window resizing:</p> <ul style="list-style-type: none"> <li>• <b>True</b></li> <li>• <b>False</b></li> </ul> <p>Default = <b>False</b></p>                         |
| Change directory on open  | <p><b>Boolean:</b> Set to be prompted to change directory upon open:</p> <ul style="list-style-type: none"> <li>• <b>True</b></li> <li>• <b>False</b></li> </ul> <p>Default = <b>True</b></p>                                     |
| Default working directory | <p>Select <b>Edit</b> to bring up the <b>Browse for folder</b> dialog.</p> <p>Default = none</p>  |
| Default style             | <p><b>Boolean:</b> Select from existing style list.</p> <p>Default = none</p>   |
| Default drag quality      | <p><b>Boolean:</b> Set the window drag quality.</p> <ul style="list-style-type: none"> <li>• <b>Low</b></li> <li>• <b>Medium</b></li> <li>• <b>High</b></li> </ul> <p>Default = <b>High</b></p>                                   |

Table 6-1: General Settings Properties

| Property                | Control Type: Values  |
|-------------------------|---|
| Printer output format   | <b>Boolean:</b> Set the format for printing output. <ul style="list-style-type: none"> <li>• <b>Bitmap</b></li> <li>• <b>Vector</b></li> </ul> Default = <b>Bitmap</b>              |
| Clipboard output format | <b>Boolean:</b> Set the output format for clipboard copied data. <ul style="list-style-type: none"> <li>• <b>Bitmap</b></li> <li>• <b>Vector</b></li> </ul> Default = <b>Bitmap</b> |

*Table 6-1: General Settings Properties (Continued)*

**Note**

The **Restore Defaults** button at the bottom of the Preferences Browser restores all default settings immediately.

## File Readers

Select this folder to edit file reader preferences and properties. Available file reader types and their editable properties are listed in the following tables. For more information on reading in data of various types, see [Chapter 2, “Importing and Exporting Data”](#).

### ASCII text

The ASCII text File Reader properties are:

| Property | Control Type: Values   |
|----------|--|
| None     | The ASCII text File Reader has no configurable properties other than Name and Description. |

*Table 6-2: ASCII Text File Reader Properties*

### Binary data

The Binary data File Reader properties are:

| Property | Control Type: Values   |
|----------|--|
| None     | The Binary data Graphics File Reader has no configurable properties other than Name and Description. |

*Table 6-3: Binary Data File Reader Properties*

### DICOM Image

The DICOM Image File Reader properties are:

| Property | Control Type: Values  |
|----------|---|
| None     | The DICOM Image File Reader has no configurable properties other than Name and Description. |

*Table 6-4: DICOM Image File Reader Properties*

## ESRI Shapefile

The ESRI Shapefile File Reader properties are:

| Property           | Control Type: Values   |
|--------------------|--|
| Combine all shapes | <b>Boolean:</b> If True then combine all of the shapes within the file into a single visualization (ShapePolygon, ShapePolyline, or ShapePoint). The default is to create a separate visualization for each shape.   |
| Name attribute     | <b>String List:</b> If the shapefile has attributes associated with each shape, then the Shapefile reader will attempt to use one of these attributes for the Name of the newly-created data and visualizations. The droplist contains all of the available attributes, and allows you to choose a different attribute to be used for the visualization name. If "Combine all shapes" is True then this property is insensitive, and the filename will be used for the Name of the resulting data and visualization. |

*Table 6-5: ESRI Shapefile File Reader Properties*

## Graphics Interchange Format

The Graphics Interchange Format (GIF) File Reader properties are:

| Property    | Control Type: Values  |
|-------------|---|
| Image index | <b>Number:</b> The index of the image within the GIF file that should be read into the image data object. |

*Table 6-6: GIF File Reader Properties*

## iTools State

The iTools State File Reader properties are:

| Property | Control Type: Values   |
|----------|--|
| None     | The iTools State File Reader has no configurable properties other than Name and Description. |

*Table 6-7: iTools State File Reader Properties*

## Joint Photographic Experts Group

The Joint Photographic Experts Group File Reader properties are:

| Property | Control Type: Values   |
|----------|--|
| None     | The Joint Photographic Experts Group File Reader has no configurable properties other than Name and Description. |

*Table 6-8: Joint Photographic Experts File Reader Properties*

## JPEG2000

The JPEG2000 File Reader properties are:

| Property          | Control Type: Values   |
|-------------------|--|
| Levels to discard | A droplist giving the number of highest resolution levels which will not appear in the result. Image dimensions are divided by 2 to the power of this number. For example, if the image in the object has dimensions of 1024 x 1026, and DISCARD_LEVELS is set to 3, the resulting image will have dimensions of 128 x 129, which is the ceiling of [1024, 1026] divided by $2^3$ . The default is "None", implying that the full resolution image will be returned. |
| Quality layers    | A droplist giving the maximum number of quality layers which will be returned in the result. Each layer contains the information required to represent the image at a higher quality, given the information from all the previous layers. A value of "All", the default, implies that all layers should be returned.   |

*Table 6-9: JPEG2000 File Reader Properties*

## Macintosh PICT

The Macintosh PICT File Reader properties are:

| Property | Control Type: Values   |
|----------|--|
| None     | The Macintosh PICT File Reader has no configurable properties other than Name and Description. |

*Table 6-10: Macintosh PICT File Reader Properties*

## Portable Network Graphics

The Portable Network Graphics File Reader properties are:

| Property | Control Type: Values  |
|----------|---|
| None     | The Portable Network Graphics File Reader has no configurable properties other than Name and Description. |

*Table 6-11: Portable Network Graphics File Reader Properties*

## Tag Image File Format

The Tag Image File Format File Reader properties are:

| Property    | Control Type: Values   |
|-------------|--|
| Image index | <b>Number:</b> Level at which to begin image index. Edit the number to change the value. Default = 0 |

*Table 6-12: Tag Image File Format File Reader Properties*

| Property       | Control Type: Values   |
|----------------|--|
| Image Stacking | <p><b>String List:</b> Image stacking method. Select a method from the list. Choose between these values:</p> <ul style="list-style-type: none"> <li>• +X</li> <li>• -X</li> <li>• +Y</li> <li>• -Y</li> <li>• +Z</li> <li>• -Z</li> </ul> <p>Default = <b>Read Single Image</b></p> |

*Table 6-12: Tag Image File Format File Reader Properties (Continued)*

## Windows Bitmap

The Windows Bitmap File Reader properties are:

| Property | Control Type: Values   |
|----------|--|
| None     | The Windows Bitmap File Reader has no configurable properties other than Name and Description. |

*Table 6-13: Windows Bitmap File Reader Properties*

## Windows Waveform Audio Stream

The Windows Waveform Audio Stream File Reader properties are:

| Property | Control Type: Values  |
|----------|---|
| None     | The Windows Waveform Audio Stream File Reader has no configurable properties other than Name and Description. |

*Table 6-14: Windows Waveform Audio Stream File Reader Properties*

## File Writers

Select this folder to edit file write preferences and properties. Available file writer types and their editable properties are shown in the following tables. For more information on writing data of various types, see [Chapter 2, “Importing and Exporting Data”](#).

### ASCII text

The ASCII text File Writer properties are:

| Property           | Control Type: Values  |
|--------------------|---|
| Separator          | Enter a value.<br>Default = None  |
| Use default format | <b>Boolean:</b> Use default format? Choose <b>True</b> or <b>False</b> .<br>Default = <b>True</b> |
| Format string      | <b>Number:</b> Enter a number to change the value.<br>Default = G9 . 2                            |

Table 6-15: ASCII Text File Writer Properties

### Binary data

The Binary data File Writer properties are:

| Property      | Control Type: Values  |
|---------------|---|
| Byte ordering | <b>String List:</b> Byte ordering type. Select from the list. Choose between these values: <ul style="list-style-type: none"> <li>• <b>Native</b></li> <li>• <b>Little endian</b></li> <li>• <b>Big endian</b></li> </ul> Default = <b>Native</b> |

Table 6-16: Binary Data File Writer Properties



## Encapsulated Postscript

The Encapsulated Postscript File Writer properties are:

| Property        | Control Type: Values   |
|-----------------|--|
| Graphics format | Bitmap or Vector: Render graphics using bitmap or vector output<br><b>Note</b> - Only a Window or View can be exported to EPS. |
| Color model     | RGB or CMYK  |

*Table 6-17: Encapsulated Postscript File Writer Properties*

## Graphics Interchange Format

The Graphics Interchange Format (GIF) File Writer properties are:

| Property | Control Type: Values  |
|----------|---|
| None     | The Graphics Interchange Format File Writer has no configurable properties other than Name and Description. |

*Table 6-18: GIF File Writer Properties*

## iTools State

The iTools State File Writer properties are:

| Property | Control Type: Values  |
|----------|---|
| None     | The iTool State File Writer has no configurable properties other than Name and Description. |

*Table 6-19: iTools State File Writer Properties*

## Joint Photographic Experts Group

The Joint Photographic Experts Group File Writer properties are:

| Property | Control Type: Values   |
|----------|--|
| Color    | <p><b>String List:</b> Select a depth from the list. Choose between these values:</p> <ul style="list-style-type: none"> <li>• <b>TrueColor</b></li> <li>• <b>Grayscale</b></li> </ul> <p>Default = <b>TrueColor</b></p> |
| Quality  | <p><b>Number:</b> Factor from 0 - 100 determining the level of quality. Move slider to change the level.</p> <p>Default = 75</p>   |

*Table 6-20: Joint Photographic Experts Group File Writer Properties*

## JPEG2000

The JPEG2000 File Writer properties are:

| Property       | Control Type: Values  |
|----------------|---|
| Reversible     | <b>Boolean:</b> Use reversible (lossless) compression.  |
| Wavelet levels | <b>Number:</b> The number of wavelet decomposition levels, or stages, in the range of 0...15. Higher values take longer to store and read, but may give better compression. The default is 5.   |
| Quality layers | <b>Number:</b> A positive integer specifying the number of quality layers. Each layer contains the information required to represent the image at a higher quality, given the information from all the previous layers. A larger number of layers takes longer to encode and produces a larger file, but provides more flexibility when decoding. |

*Table 6-21: JPEG2000 File Writer Properties*

## Macintosh PICT

The Macintosh PICT File Writer properties are:

| Property | Control Type: Values   |
|----------|--|
| None     | The Macintosh PICT File Writer has no configurable properties other than Name and Description. |

*Table 6-22: Macintosh PICT File Writer Properties*

## Portable Network Graphics

The Portable Network Graphics File Writer properties are:

| Property  | Control Type: Values   |
|-----------|--|
| Bit depth | <p><b>String List:</b> Bit depth in bits. Select a depth from the list. Choose between these values:</p> <ul style="list-style-type: none"> <li>• <b>Automatic</b></li> <li>• <b>8 bit</b></li> <li>• <b>24 bit</b></li> </ul> <p>Default = <b>Automatic</b></p> |

*Table 6-23: Portable Network Graphics File Writer Properties*

## Tag Image File Format

The Tag Image File Format File Writer properties are:

| Property  | Control Type: Values   |
|-----------|--|
| Bit depth | <p><b>String List:</b> Bit depth in bits. Select a depth from the list. Choose between these values:</p> <ul style="list-style-type: none"> <li>• <b>Automatic</b></li> <li>• <b>8 bit</b></li> <li>• <b>24 bit</b></li> </ul> <p>Default = <b>Automatic</b></p> |

*Table 6-24: Tag Image File Format File Writer Properties*

| Property    | Control Type: Values  |
|-------------|---|
| Compression | <p><b>String List:</b> Compression type. Select a type from the list. Choose between these values:</p> <ul style="list-style-type: none"> <li>• <b>None</b></li> <li>• <b>Packbits</b></li> <li>• <b>JPEG</b></li> </ul> <p>Default = <b>None</b></p> |

*Table 6-24: Tag Image File Format File Writer Properties (Continued)*

## Windows Bitmap

The Windows Bitmap File Writer properties are:

| Property  | Control Type: Values   |
|-----------|--|
| Bit depth | <p><b>String List:</b> Bit depth in bits. Select a depth from the list. Choose between these values:</p> <ul style="list-style-type: none"> <li>• <b>Automatic</b></li> <li>• <b>8 bit</b></li> <li>• <b>24 bit</b></li> </ul> <p>Default = <b>Automatic</b></p> |

*Table 6-25: Windows Bitmap File Writer Properties*

## Windows Enhanced Metafile

The Windows Enhanced Metafile File Writer properties are:

| Property        | Control Type: Values  |
|-----------------|---|
| Graphics format | <p>Bitmap or Vector: Render graphics using bitmap or vector output</p> <p><b>Note</b> - Only a Window or View can be exported to EMF.</p> |

*Table 6-26: Windows Enhanced Metafile File Writer Properties*



# Chapter 7

# Common Operations

This chapter describes the following common tasks that can be performed with all of the IDL Intelligent Tools:

---

|                                       |     |   |     |
|---------------------------------------|-----|---|-----|
| <a href="#">Introduction</a> .....    | 110 | <a href="#">Morphing</a> .....                          | 125 |
| <a href="#">File Operations</a> ..... | 111 | <a href="#">Additional Operations</a> .....             | 126 |
| <a href="#">Rotation</a> .....        | 113 | <a href="#">Rendering Translucent Objects</a> .....     | 130 |
| <a href="#">Transformations</a> ..... | 117 | <a href="#">Operations on Regions of Interest</a> ..... | 131 |
| <a href="#">Filtering</a> .....       | 120 | <a href="#">Printing</a> .....                          | 132 |

# Introduction

The six Standard IDL iTools supplied in the IDL distribution (iPlot, iSurface, iImage, iContour, iVolume, and iMap) each have many common operations. This chapter discusses the use of these common operations.

---

**Note**

This chapter describes only the Standard IDL iTools, those iTools supplied in the IDL distribution. Other iTools written by users and third-party developers share a common interface with the RSI iTools because the iTools framework is used to create all iTools. However, the specific functionality of such iTools may be different from the functionality of the iTools described here.

---

# File Operations

File operations are provided in the iTools to allow you to open files, save files, import variables and files, export variables, or export the contents of the iTool window as an image file.

## Opening Files

Data files, text files, and previously saved iTools State (\*.isv) files can be opened with **File** → **Open**. For more information on opening files, see [“Using File Open”](#) on page 32.

## Importing Variables and Files

IDL variables and files can be imported into the current iTool with **File** → **Import**. The IDL Data Import Wizard offers you the choice of importing a variable or a file, and then asks you to identify the location of the data source and the type of visualization to be created with the data.

### Import a Variable

The Data Import Wizard can import an IDL variable created at the IDL command line or exported from an iTool session into the current iTool. For more information on importing variables, see [“Importing Data from the IDL Session”](#) on page 41.

### Import a File

The Data Import Wizard can import text files, data files, or image files into the current iTool. For more information on importing files, see [“Importing ASCII Data”](#) on page 34, [“Importing Binary Data”](#) on page 35, or [“Importing Image Data”](#) on page 34.

## Saving Files

The current state of the iTool can be saved as an iTools State (\*.isv) file. Whenever you close an iTool window, you will be prompted to save the current state as an \*.isv file so that you can return to the current state of the data later when you open the \*.isv file. Other IDL users running IDL 6.2 for Windows, UNIX or Mac OS X can open \*.isv files.

## Save

**File** → **Save** saves the state of the current iTool to a file. If the file has already been saved, it will be saved under the same filename it was previously saved under. If the state has not been previously saved and has no filename, enter a filename. The saved file can be opened by IDL on either the Windows or the UNIX platform.

## Save As...

**File** → **Save As** also saves the state of the current iTool to a file, but it prompts you to enter a filename even if the file has been saved previously. Use **Save As** to save an existing iTools State file under a different name.

## Exporting Variables and Files

Data items created within the current iTool can be exported as IDL Variables, and the contents of the current iTool window can be exported as an image file. Select **File** → **Export**, and follow the instructions in the IDL Data Export Wizard.

### Export as a Variable

Data from the currently selected object can be exported as a variable from the IDL Data Export Wizard to the main IDL program.

For more information, see [“Exporting Data to the IDL Session”](#) on page 48.

### Export as a File

The contents of the current window can be exported from the IDL Data Export Wizard as an image file.

For more information, see [“Exporting Data to a File”](#) on page 45.

## Exiting the iTool

Clicking the Close button  on the iTool window will close the selected window.

**File** → **Exit** also closes the iTool window. You will be prompted to save any changes to the current state (see **File** → **Save** above for details). All visualizations and views within the window are removed from memory.



# Rotation

The iTools provide a number of ways to rotate graphical objects. Objects that are 3-D can be rotated freely or along an axis using the mouse. In addition, both 2-D and 3-D objects can be rotated left or right in 90-degree increments, or they can be rotated by a specified number of degrees. These tools rotate the entire data space.

---



**Note**

Special consideration should be given when attempting to rotate a graphic image object within iImage. See for more details.

---

## Mouse Rotation

To rotate a 3-D object with the mouse:

1. Select the object in the iTool window.
2. Click Rotate  on the toolbar to enter Rotate mode. The rotation sphere, consisting of circular x-, y-, and z-dimension axes, is displayed around the object, as illustrated in [Figure 7-1](#) and [Figure 7-2](#):
3. 3-D objects can be constrained to rotate only along one of the three displayed axes, or they can be rotated freely.
  - To rotate an object along an axis, position the mouse pointer on the axis. The constrained rotation pointer  is displayed. Drag in the desired direction to rotate the object along the selected axis.

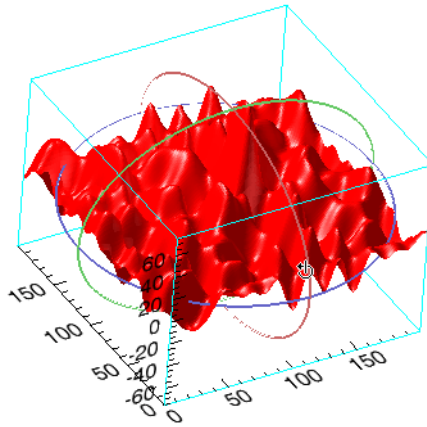

*Figure 7-1: Rotating a 3-D Object*

- To rotate an object freely, position the mouse pointer anywhere on the object. The free rotation pointer  is displayed. Drag in any direction to rotate the object in that direction.

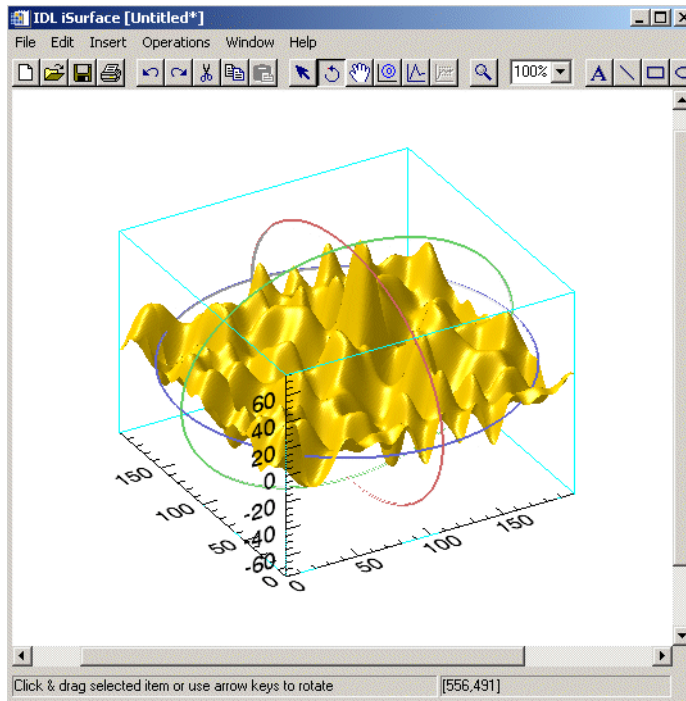



Figure 7-2: Free Rotation

4. Click  or select **Edit** → **Undo** to undo the rotation, or click  to leave rotate mode.

## Rotate Left and Rotate Right

To rotate a selected 2-D or 3-D object 90° left or right, select **Operations** → **Rotate** → **Rotate Left** or **Operations** → **Rotate** → **Rotate Right**.

### Note

For three-dimensional objects, the rotation is about the Z axis.

## Rotate by Specified Angle

To rotate a selected 2-D or 3-D object a specific number of degrees, select **Operations** → **Rotate** → **Rotate by Angle**, specify the number of degrees in the Rotate Angle dialog, and click **OK**.

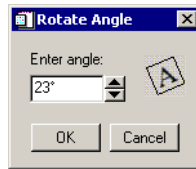

*Figure 7-3: Rotate Angle Dialog*

---

### Note

For two-dimensional objects (such as plots, images, annotations, contours, and so on) the angle is absolute. The rotation angle is remembered and displayed in the **Rotate By Angle** dialog. So for example, you can set the angle to zero degrees to make your visualization angle rotate back to zero. For 3D visualizations, Rotate by Angle is relative and does not remember the current rotation angle.

---

# Transformations

Three types of transforms are common to all iTools: Resample, Rotate Data, and Scale Data.

## Resample

The **Resample** transform resamples the selected data. Resampling operation properties include factors for each dimension of the data, as well as the interpolation method to be used.

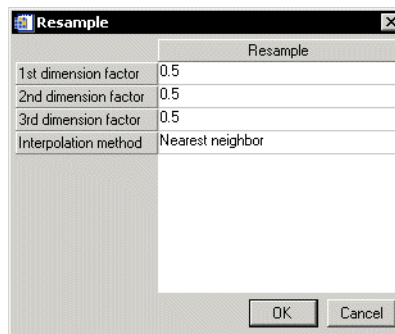

Figure 7-4: Resample Dialog

For example, if the X, Y, or Z value of a visualization needs to be different from the original data value, you can resample the data to adjust the X, Y, or Z value by the specified resample factor. Or, if the default interpolation method produces undesirable artifacts in the visualization of the data, you can resample the data with a different interpolation method.

To resample data:

1. Select one or more objects in the iTool window for resampling.
2. Select **Operation** → **Transform** → **Resample**.
3. Use the property sheet that appears to specify the resampling factor in each dimension, along with the interpolation method. See “[Resample Properties](#)” on page 388 for details.
4. Click **OK** to resample the data, or **Cancel** to abort the operation.

**Note**

For more information on the iTool's Operations Browser, see [Appendix C](#), “Operations Properties”.

## Rotate Data

The Rotate Data transform makes it possible to rotate the data within the visualization by a specified number of degrees without affecting the rest of the data space (graphical objects and axes).

To rotate data:

1. Select the visualization.
2. Select **Operation** → **Transform** → **Rotate Data**. The Rotate Data dialog is displayed.

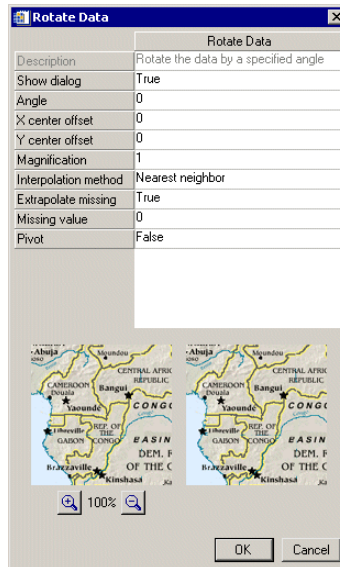

Figure 7-5: Rotate Data Dialog

3. Specify the number of degrees to rotate by clicking the up-down control, or by editing the text.

4. Click OK.

## Scale Data

The Scale Data transform makes it possible to scale the data within an object by a specified scale factor.

To scale data:

1. Select one or more objects which contain the data to be scaled.
2. Select **Operations** → **Scale Data**. The Scale Data dialog appears.

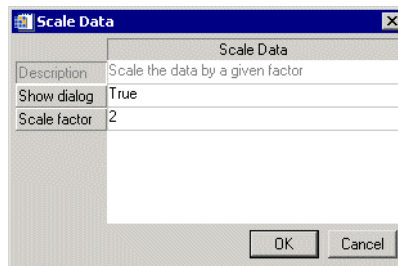

*Figure 7-6: Scale Data Dialog*

3. Change the scale factor, if necessary, by editing the number in the Scale Factor field, and click **OK** to scale the selected object(s) or **Cancel** to close the Scale Data dialog without scaling the object(s).

# Filtering

Four types of filters are common to all iTools: Smooth filtering, Median Filtering, Convolution, and Unsharp Masking.

## Smooth Filter

To remove unwanted noise from data, apply the Smooth filter to the data.

To apply the Smooth filter:

1. Select the data that you want to smooth.
2. Select **Operations** → **Filter** → **Smooth**.
3. The smooth filter editor appears (as shown in the following figure) and desired settings can be edited.

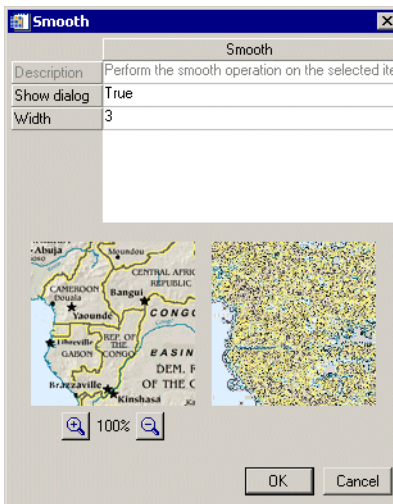

Figure 7-7: The Smooth Filter Editor

4. Click **OK** and the filter is applied.



## Median Filter

Median smoothing replaces each point with the *median* (a value in an ordered set of values with an equal number of values above and below it) of the one- or two-dimensional neighborhood of a given width. It is similar to smoothing with a boxcar or average filter, but does not blur edges larger than the neighborhood. Median filtering is effective in removing “salt and pepper” noise (isolated high or low values).

To apply the Median filter:

1. Select the data that you want to smooth.
2. Select **Operations** → **Filter** → **Median**.
3. The median filter editor appears (as shown in the following figure) and desired settings can be edited.



Figure 7-8: The Median Filter Editor

4. Click **OK** and the filter is applied.

## Convolution Filter

To convolve data:

1. Select the data to be convolved.
2. Select **Operations** → **Filter** → **Convolution**. The **Convolution Kernel Editor** dialog is displayed.

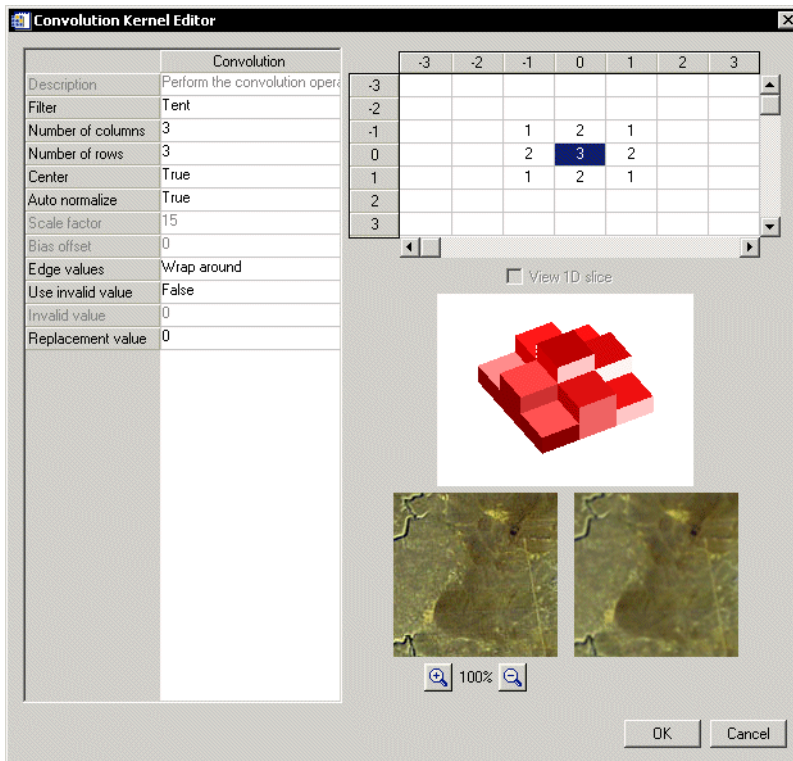

Figure 7-9: Convolution Kernel Editor

The dialog displays an image preview for two-dimensional data only. The **View 1D slice** option is always disabled when you use the editor with existing data. You have access to the option when you open the editor through the Operations Browser (see “[Convolution Properties](#)” on page 380).

3. Change **Convolution Kernel Editor** settings as necessary by modifying any of the following items in the property sheet:
  - **Filter** — select a filter type from the list. The default filter is **Tent**.
  - **Number of Columns (Rows)** — edit if necessary.
  - **Center** — position is centered by default. Select **False** to turn centering off.
  - **Auto normalize** — scaling is automatic by default. To use a different scale factor, select **False** and enter a value in the **Scale factor** property field. You can also set **Bias offset** to add an offset that will be added to the results after **Scale factor**.
  - **Edge values** — edges wrap around by default. To choose a different edge format, select **Zero result**, **Repeat last value**, or **Zero pad** from the list.
  - **Use invalid value** — filtering missing data is off by default. To filter missing data using an invalid value, select **True** and enter the value in the **Invalid value** property field. You can also set **Replacement value** to give IDL a value that will replace missing results.
4. Click **OK** to apply the filter with the current settings and close the Convolution Kernel Editor window, or click **Cancel** to close the window without applying the filter.

## Unsharp Mask Filter

An unsharp-mask filter can be applied to any two-dimensional array or a TrueColor image. The unsharp mask enhances the contrast between neighboring pixels in an image, and is widely used for astronomical images and for digital photographs.

To apply the Unsharp Mask filter:

1. Select the data that you want to unsharp mask.
2. Select **Operations** → **Filter** → **Unsharp Mask**.
3. The unsharp mask filter editor appears (as shown in the following figure) and desired settings can be edited.

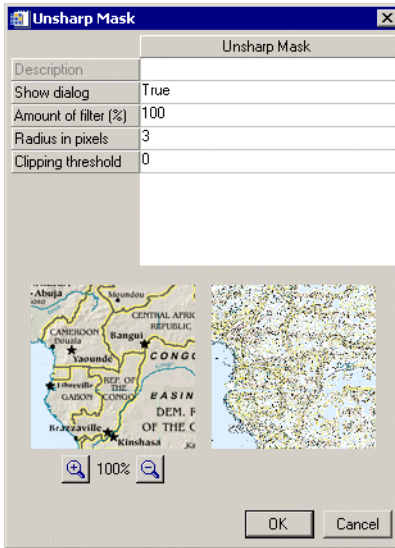

Figure 7-10: The Unsharp Mask Filter Editor

4. Click **OK** and the filter is applied.

# Morphing

Mathematical morphology is a method of processing digital images on the basis of shape. Morphing is available when working with images, surfaces, and contours. Six morphing options are available for use in iTools: dilate, erode, morph open, morph close, morph gradient, and morph tophat.

| Morphing Option | Description  |
|-----------------|--|
| Dilate          | <b>Dilate</b> is commonly known as “fill”, “expand”, or “grow.” It can be used to fill “holes” of a size equal to or smaller than the structuring element.   |
| Erode           | <b>Erode</b> does to the background what dilation does to the foreground. Given an image and a structuring element, erode can be used to remove islands smaller than the structuring element.                  |
| Morph open      | <b>Morph open</b> is simply an erosion operation followed by a dilation operation. Applying morph open more than once produces no further effect.  |
| Morph close     | <b>Morph close</b> is simply a dilation operation followed by an erosion operation. Applying morph close more than once produces no further effect.  |
| Morph gradient  | <b>Morph gradient</b> is the subtraction of an eroded version of the original image from a dilated version of the original image.  |
| Morph tophat    | <b>Morph tophat</b> is implemented by first applying the opening operator to the original image, then subtracting the result from the original image. Applying tophat shows the bright peaks within the image. |

*Table 7-1: Morph Menu Options*

To apply a morphology option:

1. Select the object to be morphed.
2. Select **Operations** → **Morph** → *<option>*.

# Additional Operations

The Histogram, Statistics, and Console tools display additional information about data displayed in the iTool windows, and about operations performed with the iTools.

## Plotting a Histogram

**Histogram** displays a histogram plot of the data currently selected in the iTool window. The Histogram plot appears in a separate iPlot window.

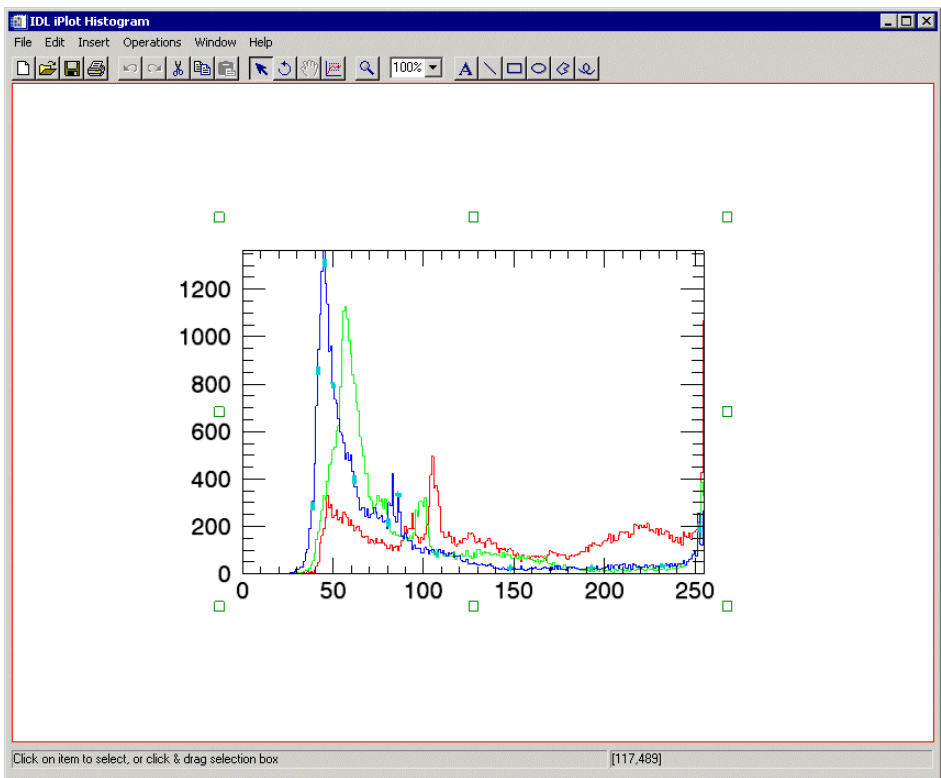

*Figure 7-11: Histogram Plot*

To display a histogram plot:

1. Select an object or group of objects in the iTool window.
2. Select **Operations** → **Histogram**.

## Displaying Statistics

The Statistics dialog displays all available statistical information pertaining to the object or objects currently selected in the iTool window.

To display the Statistics dialog:

1. Select an object or a group of objects in the iTools window.
2. Select **Operations** → **Statistics**. The Statistics window is displayed.

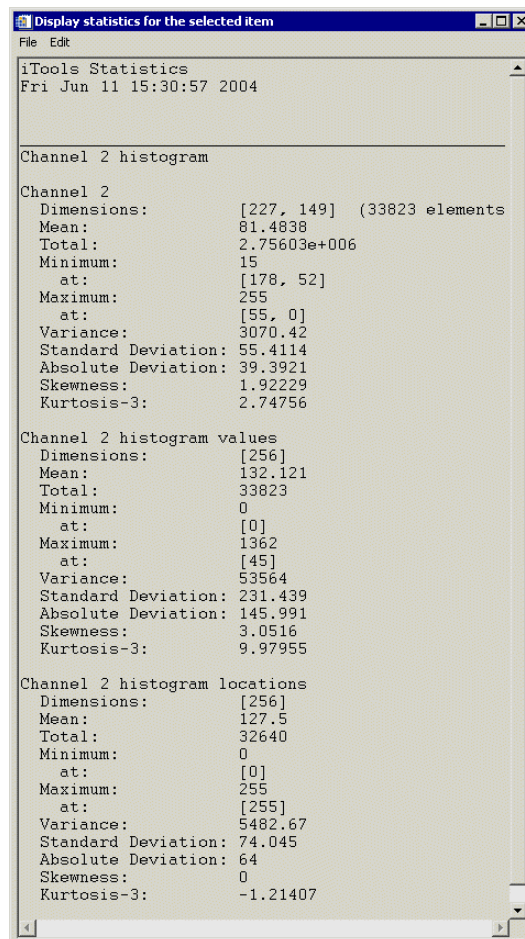

Figure 7-12: The iTools Statistics Window

The information displayed in the Statistics window varies depending upon the type of objects selected.

- For scalars, the name of the variable and its value are displayed in the Statistics window.
- For arrays, the following information is displayed:
  - Name
  - Maximum and location
  - Dimensions
  - Standard deviation
  - Mean
  - Variance
  - Absolute deviation
  - Total
  - Skewness
  - Minimum & location
  - Kurtosis - 3

The information in the Statistics window can be edited (by selecting **Edit**), printed, or saved as a file.

- On Windows platforms, the standard Windows editing context menu containing Cut, Copy, Paste and Delete commands can be displayed by right-clicking anywhere in the Statistics window.
- On UNIX platforms, use the left or right mouse buttons to cut, copy or paste.

To save the text as an ASCII file:

1. Select **File** → **Save As**.
2. Enter a filename. If the filename already exists, you will be asked if you want to replace the file.
3. Select **Cancel** to return to the Statistics window without saving the file.

To print the text, select **File** → **Print**. The standard Windows or Motif printer dialog is displayed.

To close the Statistics window, select **File** → **Close**.



## Resetting Dataspace Ranges

You can reset the ranges of your data space to accommodate all your contained visualizations. When you reset your ranges, the following properties of the data space are reset to a value of True:

- Automatic X range updates
- Automatic Y range updates
- Automatic Z range updates

To reset the ranges of your data space, select **Window** → **Reset Dataspace Range**.

# Rendering Translucent Objects

Within iTools, you can set the transparency of an object to make it appear totally opaque, transparent, or translucent. Isosurface objects are just such a case. Text objects can also be made partially transparent so that you can see through the labels on a complex plot and still see both the labels and the data. In the majority of scenarios where you will utilize opaque data objects and translucent text labeling, this translucent rendering works very well.

It is important to know, however, that translucent rendering does not always work well in more complex situations. This is because translucent objects must be strictly rendered from the back (far from the viewer) towards the front (closer to the viewer). IDL accomplishes translucent rendering by blending the pixels already drawn on the device with the pixels that are drawn to represent a translucent object. Therefore, it is important that the objects that are positioned behind the translucent object be rendered before the translucent object. If the ordering is not correct, then you will not be able to see the objects behind the translucent object.

For most cases in iTools, ordering is not a problem. If you encounter it as a problem, the **Bring to Front** (and related) operation can help you improve the appearance of your translucent objects. In some cases, however, the ordering is not easily accomplished. For example, a complex isosurface rendered as a translucent object does not always appear correct from all angles.

An isosurface is composed of a large number of triangles stored in an IDLgrPolygon object. The triangles are always drawn in the same order, the order in which they are stored in the object. Thus, as the viewing angle changes, the apparent back-to-front ordering of the triangles also changes. In some cases, the triangles closest to the viewer draw first and end up blocking the view of other triangles drawn later and behind them that should be visible through the translucent triangles drawn first.

For all these reasons, transparency should be used with care in dealing with objects like a complex isosurface. The rendering of these objects ultimately may not appear correct.

---

## Note

For more detailed information on alpha channel support in IDL Object Graphics, see [“Controlling Object Transparency”](#) in Chapter 2 of the *Object Programming* manual.

---

# Operations on Regions of Interest

A *region of interest* (or ROI) is an area that contains data you wish to identify. An ROI can be drawn anywhere within your image and can be selected from rectangular, elliptical, polygonal, and freehand region of interest buttons on the iImage Image Panel. You can also apply operations to image data contained within an ROI area.

Some operations applied to ROIs affect the ROI data while others affect the ROI vertices.

## Operations Modifying ROI Data

If the operation acts on the pixel values of the underlying data, the pixels that are contained within the ROI are changed as a result of the operation. Pixel values outside of the ROI area remain unchanged but pixel values within the ROI are set to correspond with the pixel result of the chosen operation.

Examples of operations acting upon the ROI data are:

- Filter operations including Convolution, Median, Smooth, Roberts, and Sobel
- Morphological operations
- Transform operations including scaling and inverting data

## Operations Modifying ROI Vertices

If the operation acts on the vertices of the ROI itself, the vertices are changed as a result of the operation. If the entire image is selected for an operation, the ROI will follow the behavior of the entire image as the operation acts upon it. If only the ROI is selected, then only the ROI will respond to the operation.

Examples of operations acting upon the ROI vertices are:

- Rotate right, left, or by a specified angle
- Flip horizontal or vertical
- Region grow

# Printing

**File** → **Print** sends the current view of the contents of the graphics window to the specified printer via the standard Windows or Motif printer dialog. If the contents have been modified in the current view, they will appear modified in the printer output.

To print the contents of the graphics window:

1. Select **File** → **Print**. The standard Windows or Motif printer dialog appears.
2. Select the desired printer and printer properties from the printer dialog.
3. Click **Print**. The current view of the contents of the graphics window is sent to the chosen printer, with the chosen options.

## Print Preview

The **Print Preview** dialog in iTools allows you to view and manipulate your iTool window content before sending it to the printer.

To open the **Print Preview** dialog, select **File** → **Print Preview...**

You can reposition your content in the Print Preview window by clicking it and dragging it to a new location. If you move your content in such a way that part of it is no longer visible in the **Print Preview** dialog, this same part will not be shown when printed.

---

### Note

If your **Print Preview** dialog shows the red border, it will not appear on paper when printed.

---

You can resize your content by clicking and dragging the small black rectangle at the upper right corner of the window area. The aspect ratio of the content cannot be changed. If **Center** is unchecked then the content will be resized while keeping the location of the lower left corner static. If **Center** is checked then resizing will take place while keeping the content centered.

The **Print Preview** dialog and its functions are shown here:

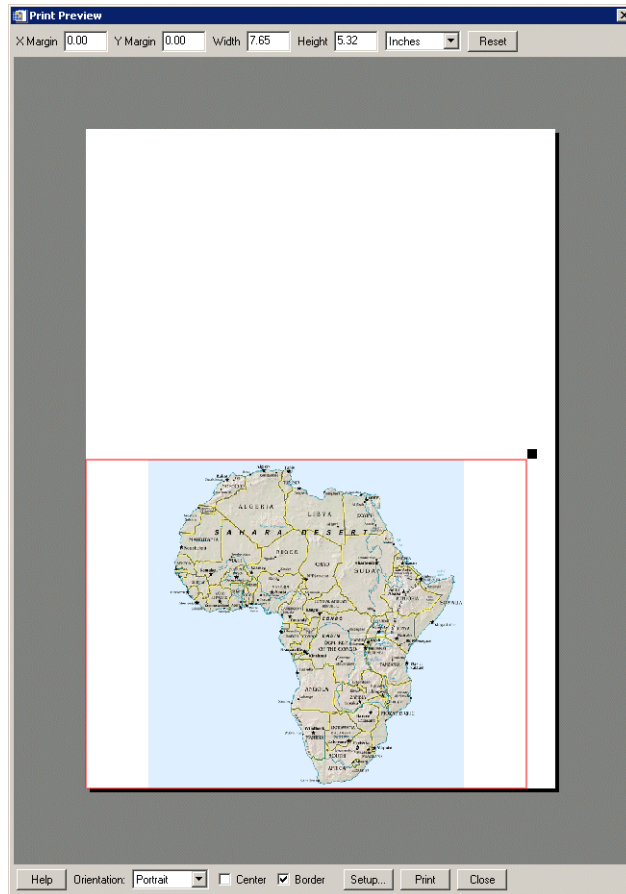

Figure 7-13: The **Print Preview** Dialog

| Component | Function  |
|-----------|---|
| X Margin  | Sets the left margin to your desired value. Values can be manually entered. |

Table 7-2: *Print Preview Functions*

| Component   | Function  |
|-------------|---|
| Y Margin    | Sets the bottom margin to your desired value. Values can be manually entered.   |
| Width       | Select your desired printout width. Values can be manually entered. Only positive values are accepted. The aspect ratio of the content is kept constant so a change in width will also change the height.   |
| Height      | Select your desired printout height. Values can be manually entered. Only positive values are accepted. The aspect ratio of the content is kept constant so a change in height will also change the width.  |
| Units       | Set width and height units in <b>inches</b> or <b>centimeters</b> . Default is <b>inches</b> .  |
| Reset       | Resets all settings to the original value when the <b>Print Preview</b> dialog was first opened. The margins, units, center, and border settings will be reset to defaults and the size is reset based on the size of the tool window.  |
| Help        | This invokes the IDL help for print and print preview procedures.   |
| Orientation | Select <b>Portrait</b> or <b>Landscape</b> . Changing the orientation will reset the X and Y margins and the width and height, unless the <b>Center</b> check box is checked, in which case the width and height will be reset but the image will remain centered. Default is <b>Portrait</b> . |
| Center      | Click to center your content on the page. When center is checked the X and Y margin text boxes are no longer available and the ability to drag the image with the mouse is removed. Default is off.   |
| Border      | Click to show or hide the content border as a red outline. The border does not print and is included only to indicate the boundary of the contents. The border setting is not saved. Default is on.   |

Table 7-2: Print Preview Functions

| <b>Component</b> | <b>Function</b>  |
|------------------|--|
| Setup            | Select to edit printer information. If the <b>Print</b> button is pressed while in the setup dialog, the contents of the <b>Print Preview</b> dialog will be printed and the dialog will be dismissed. |
| Print            | Prints the contents of the <b>Print Preview</b> dialog to the currently selected printer and closes the dialog.  |
| Close            | Closes the <b>Print Preview</b> dialog and saves the current settings without printing.  |

*Table 7-2: Print Preview Functions*







## Chapter 8

# Working with Macros

This chapter describes how to use the iTool macros.

---

|                        |     |   |     |
|------------------------|-----|---|-----|
| Introduction .....     | 138 | Using the Macro Editor .....                  | 151 |
| What Are Macros? ..... | 139 | Understanding Items in the Macro Editor ..... | 161 |
| Recording Macros ..... | 141 | Making Selection and Tool Changes .....       | 176 |
| Running Macros .....   | 144 | Importing and Exporting Macros .....          | 183 |

# Introduction

The macros in IDL iTools provide a shortcut mechanism that lets you quickly and automatically repeat a sequence of operations. You can record a series of actions in one iTool or several iTools, save the series as a macro, and then apply it to a new set of data to save you from having to repeat the actions manually.

This chapter discusses the following areas:

- More information about macros (see [“What Are Macros?”](#) on page 139)
- Recording macros (see [“Recording Macros”](#) on page 141)
- Running macros (see [“Running Macros”](#) on page 144)
- Editing macros (see [“Using the Macro Editor”](#) on page 151)
- Making selection and tool changes within a macro (see [“Making Selection and Tool Changes”](#) on page 176)
- Importing and exporting macros (see [“Importing and Exporting Macros”](#) on page 183)

# What Are Macros?

In the context of the iTools, a *macro* is a collection of operations and property values that can be applied to an existing visualization or visualizations. There are two kinds of macros, depending on what you have selected when you start recording. For more information, see [“Macro Type Based on Recording Selection”](#) on page 176.

Macros are not linked to the objects or visualizations to which they are applied. When you run a macro, the operations or property settings apply to the objects currently selected. (The macro system does include functionality to change selections and tools during the execution of a macro. For more information, see [“Making Selection and Tool Changes”](#) on page 176.) This means that property settings can be applied to multiple visualization types, unlike property settings in styles.

## Note

Property settings in macros apply to the selection, but are not tied to visualization type, whereas in styles they are tied to visualization type and might or might not apply to selection.

The following figure shows part of the display of the Macro Editor, covered in detail in [“Using the Macro Editor”](#) on page 151:

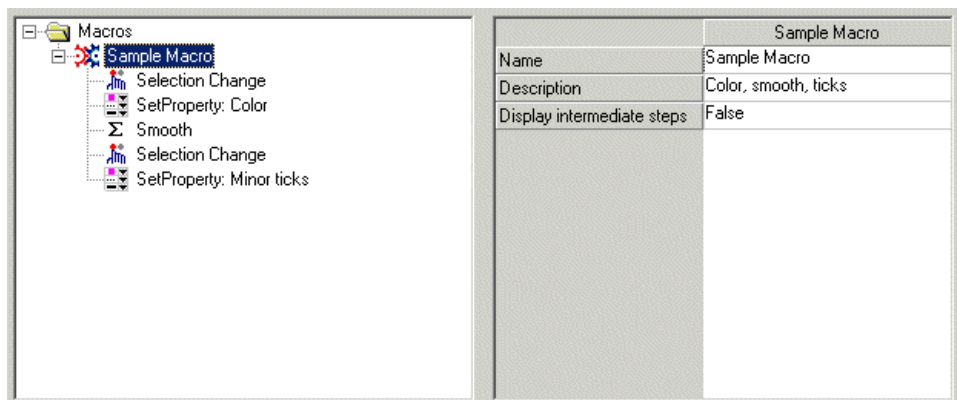

*Figure 8-1: A Macro in the iTools Macro Editor*

This figure shows an example macro called New Macro, composed of several operations and property settings. Operations in this macro change the selection and

apply the smooth operation. Property settings change the color and minor ticks properties.

Macro information is stored in one or more macro files located on your system. Macros are stored in IDL SAVE files. Macros are stored in a subdirectory of the user's `.idl` directory. When you create a new macro within an iTool, it will automatically be saved in the specified location.

**Note**

---

Macro information is never stored along with an iTool.

---

# Recording Macros

You can create macros in two ways:

- Using the recording functionality in the iTools **Operations** → **Macros** menu, described in this section
- Using the Macro Editor, described in “[Using the Macro Editor](#)” on page 151

To record a macro:

1. Start an iTool.
2. Select **Operations** → **Macros** → **Start Recording**.
3. If the **Start Recording** dialog appears (as it does if the **Show dialog** property is True), select whether to record manipulator steps and press **OK**, which puts the iTools system into recording mode.



Figure 8-2: The Start Recording Dialog

---

**Note**

For more information on recording manipulator steps, see “[Capturing Intermediate Manipulations](#)” on page 142.

---

4. Select operations or set properties as desired to create the macro.
5. Select **Operations** → **Macros** → **Stop Recording** to complete the recording.

Putting the iTools system into recording mode creates a new macro folder in the macro registry, using a unique name based on ‘New Macro’ (as shown in the macro tree; see “[The Macro Tree](#)” on page 154). If the New Macro folder already exists, then the new name is New Macro (1) and so on until the system finds a uniquely numbered name. You can change the macro’s name when macro recording finishes.

At the end of recording, IDL saves the completed macro, and the Macro Editor opens. Note that using the **Stop Recording** menu command is the only way to stop recording without exiting the iTools system. Changing tools or closing the tool does not stop recording, and a recording started in one iTool will continue to other iTools. You can select the **Stop Recording** command in any active iTool.

---

**Note**

What you select in the iTools system before starting recording dictates what happens when you run the completed macro. For more information, see “[Macro Type Based on Recording Selection](#)” on page 176.

---

## Capturing Intermediate Manipulations

A manipulation such as Translate typically consists of a series of transformations based on the screen position of the mouse. They start with a mouse-down operation and end with a mouse-up operation, but each mouse motion while the mouse button is down generates a transformation. Typically, when a manipulation such as Translate or Rotate is recorded, a single macro item is created that contains the overall translation from mouse-down to mouse-up. This applies to the history item that is created whether recording or not. When this macro item is processed during macro playback, the complete transformation is applied, but the individual transformations based on the individual mouse motions are not available.

A different mode of recording has been added which allows a recording of a manipulation to save the individual steps based on each mouse movement. This is useful if the purpose of the macro is to demonstrate the transformation such as a smooth 3D rotation of a surface. This new mode records each step of the manipulation while the mouse is down, based on the original motion events from the operating system.

A new property, **Record manipulator steps**, has been added to the **Start Recording** operation. This Boolean property lets you specify whether to record the individual movements of a manipulation. The default value is False, meaning that the macro recording captures only the overall transformation rather than individual steps. This property applies to the following manipulators when they are used within a recording:

- Rotate
- Translate (includes Image Plane translation)
- Scale
- View Pan
- View Zoom

While they are distinctly different properties, the value of **Record manipulator steps** is used to set the default value for the **Display intermediate steps** property of the macro itself. If **Record manipulator steps** is set to True when starting a recording, it is most likely that the user wants to see the intermediate steps during playback, so **Display intermediate steps** is set to True to provide that display.

Note that this property applies only to the macro item generated during recording. The history item generated for a transformation always consists of the single overall transformation, regardless of the setting of **Record manipulator steps** if recording as well as if not recording.

There are a number of other manipulators that are not affected by the **Record manipulator steps** property. For these manipulators, their primary purpose is to specify an overall movement with the mouse to specify how a succeeding operation will be applied. Therefore, an overall movement is always used to create a single macro item. These other manipulators are the following:

- Crop Box
- Range Box
- Range Pan
- Range Zoom
- Line Profile
- Surface Contour

# Running Macros

When you run a macro, its operations apply to the item or items selected in the active iTool.

---

**Note**

For more information on a macro's application to the current selection, see [“Macro Type Based on Recording Selection”](#) on page 176.

---

To run a macro, do one of the following:

- From an iTool window, select **Operations** → **Macros** → **Run Macro**
- From the Macro Editor, select the macro to run and then select **Run** → **Run Macro**
- At the IDL command line, use the `MACRO_NAMES` keyword with an iTool command

Macro items are processed sequentially, each item either applying an operation or applying property values. Macros can contain operations that change the selection so that subsequent operations or property settings apply to different visualization objects in one or more iTools. For more information, see [“Making Selection and Tool Changes”](#) on page 176.

While the macro is running, you have access to the **Macro Controls** dialog, which lets you pause, step, and stop the macro. You can also hide or show intermediate steps in the macro, set the step delay, and hide or show the macro items. For more information, see [“Using the Macro Controls Dialog”](#) on page 147.

After running a macro, you can use the **Undo/Redo** operation, which treats the actions performed by a macro as a single event. This means that if you run a macro and then select **Undo**, all of the operations and properties changed by the macro revert to their pre-macro values.



## Running from the Operations Menu

You can run a macro by selecting **Operations** → **Macros** → **Run Macros** from any open iTool. This selection opens the **Run Macro** dialog, as shown in [Figure 8-3](#).

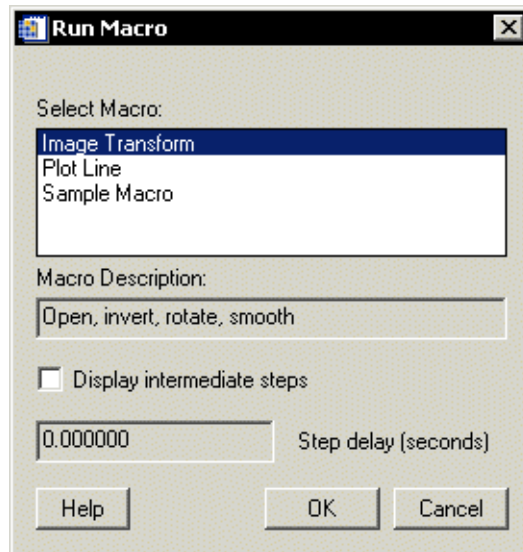

*Figure 8-3: The Run Macro Dialog*

This dialog lets you select the macro to run. The macro names are obtained from all saved macros. Macros that have been created in the macro editor, but not saved are not available. By default, the first item in the list is selected, and the description of that first macro appears in the **Macro Description** field. After you select a macro name from the list, the **Macro Description** field is updated with the description of the selected macro.

The **Display intermediate steps** option is set based on the value of the macro property of the same name. Set it to display each step of the macro as it runs, or clear it to prevent any updates of the display until the macro is complete. The **Step delay** field displays the number of seconds IDL delays between each step of the macro. You can change the delay by entering a floating-point value in the field. The minimum delay is 0.0 seconds; the maximum delay is 60.0 seconds. IDL truncates the delay value to fall within that range after you click **OK**.

The values of both of these properties are retrieved from the specified macro when you select it in the list. Changes made to these properties with this dialog affect the

succeeding invocation of the macro specified, but are not applied to the macro itself. This lets the macro properties maintain default values while the settings of the dialog can be modified for a single invocation. To make a permanent change to these properties, edit them in the Macro Editor and save your changes. For more information on these properties, see [“The Macro Property Sheet”](#) on page 154.

To run a macro from this dialog, either:

- Double-click its name in the list
- Select its name in the list and click **OK**

## Running from the Macro Editor

You can run macros from within the Macro Editor by doing the following:

1. In the macro-tree panel (top left), select the macro to run.
2. Select **Run** → **Run Macro**.

The macro runs on the selected visualization or visualizations in the active iTool.

For more information, see [“Using the Macro Editor”](#) on page 151.

## Running from the Command Line

You can also apply macros in a non-interactive situation by running them from the IDL command line.

The iTools routines (such as `IPLOT`) have a `MACRO_NAMES` keyword that you can set when calling them. For example, you can enter the following at the command line, if you have a macro named ‘plotmacro’ already defined:

```
IPLOT, RANDOMU(1, 20), MACRO_NAMES='plotmacro'
```

This command creates a simple two-dimensional plot of 20 randomly generated data points and then applies the ‘plotmacro’ macro to it.

The keyword can take either a single string, as in the example above, or an array of strings. In the latter case, the macro names are retrieved and run sequentially at the conclusion of the iTool’s actions. This action follows the creation of the iTool and, if applicable, any visualization created by the command.

### Note

---

For more information on the `MACRO_NAMES` keyword, see the iTools routine commands in the *IDL Reference Guide*.

---

## Using the Macro Controls Dialog

The **Macro Controls** dialog is a floating dialog that, when launched, appears in the bottom-right corner of the iTool window containing the running macro. You cannot resize or close it, but you can move it to a different location. It appears initially in its small or collapsed form, as shown in [Figure 8-4](#).



*Figure 8-4: The Macro Controls Dialog (Collapsed) While Running*

The **Macro Controls** dialog lets you:

- Pause and continue the currently running macro
- Step through the macro one item at a time
- Stop the macro
- Hide or show the macro's intermediate steps
- Set the step delay
- Hide or show the macro items

These actions are described in more detail below.

### Continue / Pause

If the macro is running, the button label is the pause symbol. Click this button to pause the macro. [Figure 8-4](#) shows the **Macro Controls** dialog while running.

If the macro is paused, the button label is the continue symbol. Click this button to resume macro execution. [Figure 8-5](#) shows the **Macro Controls** dialog while paused.



*Figure 8-5: The Macro Controls Dialog (Collapsed) While Paused*

**Note**

---

Under Microsoft Windows systems, you can invoke either action by pressing **F5**.

---

**Step**

When a macro is paused, you can click the button with the step symbol to execute the next macro item. When a macro is running, this button is desensitized.

**Note**

---

Under Microsoft Windows systems, you can invoke this action by pressing the right arrow key.

---

The macro step delay (if nonzero) is not applied when you click the **Step** button. In addition, the discrete delay from a Delay or Step Delay Change operation is not applied. For more information, see [“Delay Operation Item”](#) on page 172 or [“Step Delay Change Operation Item”](#) on page 172.

**Stop**

You can use the button with the stop symbol to stop execution of the macro. The remaining macro items are skipped, and the **Macro Controls** dialog is dismissed. You can use the **Stop** button while the macro is paused or running.

**Hide Steps / Show Steps**

If the intermediate steps of the macro are being displayed, the button label is the closed-eye image, for **Hide Steps**. Click this button to turn off the display of intermediate steps.

If the intermediate steps of the macro are not being displayed, the button label is the open-eye image, for **Show Steps**. Click this button to turn on the display of intermediate steps.

Using these controls lets you interactively toggle whether the display of the iTool window is updated after the execution of each macro item. This ability has several useful applications. If the list of macro items is displayed (see [“Show Macro Items / Hide Macro Items”](#) on page 149), you can monitor what the macro is doing and interactively turn on the display of intermediate steps for a particular part of the macro. You can also interactively test a macro playback when planning to insert Step Display Change operations into the macro. Inserting these operations might be useful when a macro recording contains many intermediate steps, but the author of the macro wants to show only a subset of the steps. For more information on this operation, see [“Step Display Change Operation Item”](#) on page 173.

## Set Step Delay

You can use the button with the hourglass symbol to set the step delay. This action pops up a floating dialog, shown in [Figure 8-6](#), that allows setting the step delay in seconds. The **Set Step Delay** button is active while the macro is paused and while it is running. You cannot resize the **Step Delay** window, but you can move and close it.



*Figure 8-6: The Step Delay Window of the Macro Controls Dialog*

You can set the step delay to a floating-point value by either:

- Using the **Step Delay** window's slider
- Typing a value in the window's field

The minimum value is 0.0 seconds, the maximum value is 60.0 seconds, and the default step is 0.01 seconds. You can set the step delay value while the macro is paused or running.

Modifying the step delay value does not set the macro's step delay property. Setting the step delay through the **Macro Controls** dialog applies a temporary override value that remains in effect until the end of the macro execution, until the value is modified again with the dialog, or until a [Step Delay Change Operation Item](#) (see "[Step Delay Change Operation Item](#)" on page 172).

## Show Macro Items / Hide Macro Items

If the **Macro Controls** dialog is collapsed, you can use the button with the down arrow (shown in [Figure 8-5](#)) to expand the dialog and show the macro items. During macro execution, the current macro item is selected in the tree view. When the macro is paused, the tree view shows the macro item to be executed next when you click either **Step** or **Continue**.

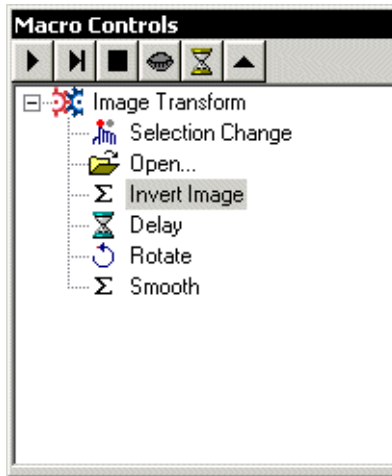

*Figure 8-7: The Macro Controls Dialog (Expanded)*

If the **Macro Controls** dialog is expanded, as shown in [Figure 8-7](#), you can use the button with the up arrow to collapse the dialog so that macro items are not displayed.

# Using the Macro Editor

You can use the Macro Editor to modify existing macros and create new macros. The Macro Editor is launched automatically after you record a macro interactively. You can also launch the Macro Editor at any time by selecting **Operations** → **Macros** → **Macro Editor** from any iTool.

The Macro Editor is a system-wide dialog, shared by all current iTools. Closing all current iTools does not close the Macro Editor.

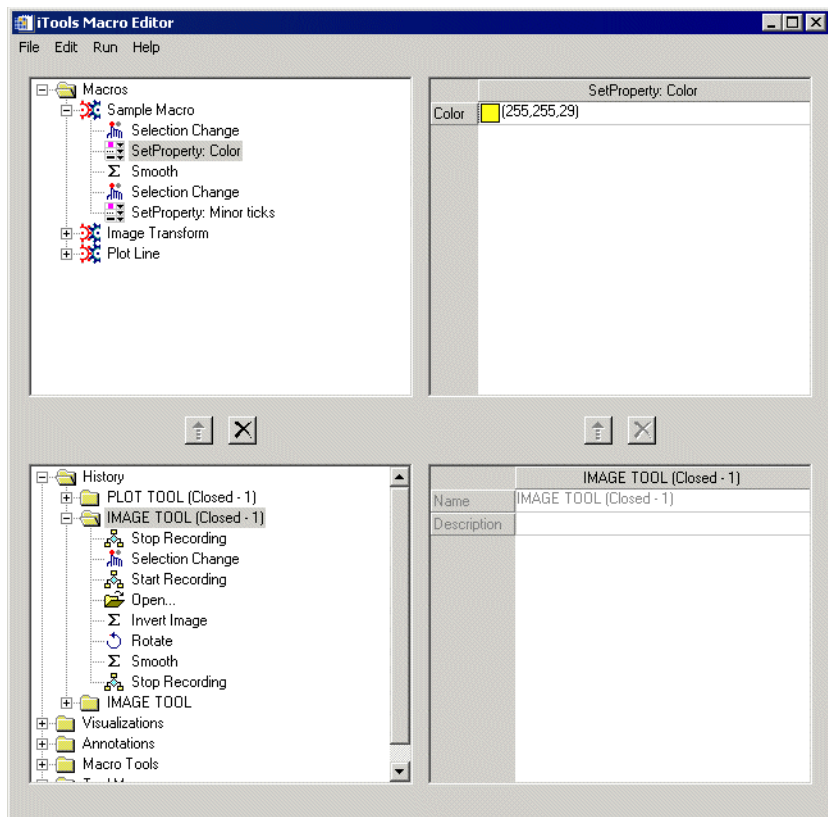

Figure 8-8: The Macro Editor

Figure 8-8 shows the Macro Editor with the History folder expanded to show the history items that were generated while the iImage tool was open (that is, all iImage

operations, whether recorded in a macro or not). The Macros folder in the upper-right panel shows a macro with its SetProperty item selected.

## Understanding the Macro Editor

The Macro Editor consists of four panels and two sets of add/remove buttons. The four panels consist of the two macro panels on the top and the two source panels on the bottom. You use the add/remove buttons to move operations and settings from the source panels to the macro panels.

### The Menu Bar

The following menus appear on the Macro Editor menu bar:

- File
- Edit
- Run
- Help

You can use the **Edit** and **Run** operations in a right-click context menu on items in the macro and source trees.

The **File** menu, shown in [Table 8-1](#), contains tools for creating, importing, exporting, and saving macros.

| Menu Selection | Function  |
|----------------|---|
| New            | Creates a new macro in the macro tree, with a name based on 'New Macro.' If New Macro already exists, then the new name is New Macro (1) and so on until the system finds a uniquely numbered name. |
| Import...      | Imports a macro from an external file. See <a href="#">“Importing and Exporting Macros”</a> on page 183 for details.  |
| Export...      | Exports the selected macro to an external file. See <a href="#">“Importing and Exporting Macros”</a> on page 183 for details.   |
| Save           | Saves all macros to external IDL SAVE files with names based on the macro names.  |

*Table 8-1: The File Menu*



| Menu Selection | Function  |
|----------------|---|
| Close          | Closes the Macro Editor, prompting you to save any unsaved macro changes. |

*Table 8-1: The File Menu (Continued)*

The **Edit** menu, shown in [Table 8-2](#), contains tools for editing, deleting, duplicating, and moving items within the macro and source trees.

| Menu Selection | Function   |
|----------------|--|
| Cut            | Copies the selected item to an internal clipboard and removes the item from the tree.  |
| Copy           | Copies the selected item to an internal clipboard.   |
| Paste          | Pastes the contents of the internal clipboard into the tree.   |
| Delete         | Deletes the selected item without making a copy. If the selected item is a SetProperty item and the last selection was in the macro property sheet, this action deletes selected properties from the SetProperty item. If the last selection was in the macro tree, the whole SetProperty item is deleted. |
| Duplicate      | Duplicates the selected item.  |
| Move Item Up   | Moves the selected item up one position in the tree.   |
| Move Item Down | Moves the selected item down one position in the tree.   |

*Table 8-2: The Edit Menu*

The **Run** menu contains only one operation: Run Macro, which runs the selected macro. See [“Running from the Macro Editor”](#) on page 146 for details.

The **Help** menu opens the online help for the Macro Editor.

## The Macro Tree

The macro tree (top left) contains folders for existing macros, as shown in [Figure 8-9](#). Macros are indicated by the gears folder icon. Macro items are indicated by their own object icons or by the SetProperty icon.

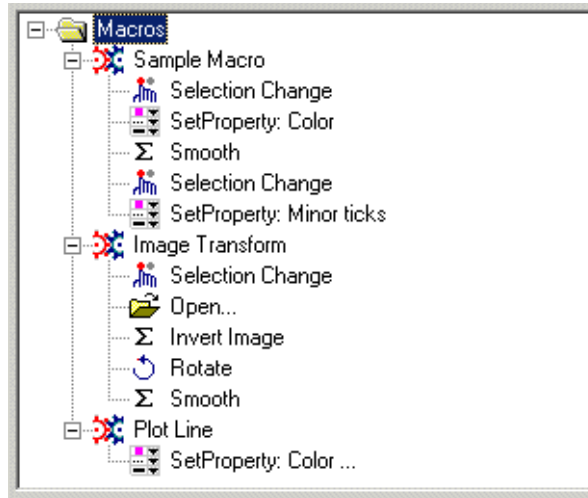

*Figure 8-9: The Macro Editor's Macro Tree*

Clicking on an item in the tree selects the item and displays its property sheet to the right of the tree panel. Right-clicking within the tree brings up the context menu of available actions (see [“The Menu Bar”](#) on page 152). If you right-click on a tree item, then that item is selected.

For more information on these items, see [“Macro Items”](#) on page 161.

## The Macro Property Sheet

The macro property sheet (top right) lets you set properties of macro folders and items.

To see a macro's properties, click on its folder in the macro tree. The macro's properties appear in the macro property sheet, as shown in [Figure 8-10](#). To change any of the properties, click on it in the sheet and make the modification you want.

| Sample Macro               |                      |
|----------------------------|----------------------|
| Name                       | Sample Macro         |
| Description                | Color, smooth, ticks |
| Display intermediate steps | False                |
| Step delay (seconds)       | 0                    |
|                            |                      |

Figure 8-10: The Macro Editor’s Macro Property Sheet: Macro Properties

Macros have several properties, described in [Table 8-3](#).

| Property                   | Value   |
|----------------------------|---|
| Name                       | Used to select the desired macro from the Run Macro dialog (for more information, see <a href="#">“Running from the Operations Menu”</a> on page 145). Also serves as the basis for the filename of a saved macro.        |
| Description                | Used to describe the behavior or purpose of the macro. Its value appears in the <b>Run Macro</b> dialog’s <b>Description</b> field when you select a macro from the list.   |
| Display intermediate steps | Typically set to False so that the display updates only on completion of the macro. Set this property to True to display each step of the macro, which might be useful when using a macro to animate a series of actions. |

Table 8-3: Macro Property Values

| Property             | Value  |
|----------------------|--|
| Step delay (seconds) | Used to specify the time in seconds to delay between each step of the macro. The default value is 0.0. The minimum value is 0.0, and the maximum value is 60.0.<br><br><b>Note</b> - You can also add the Delay operation to a macro to create a single specific delay (see “ <a href="#">Delay Operation Item</a> ” on page 172). |

*Table 8-3: Macro Property Values (Continued)*

**Note**

If **Display intermediate steps** is set to False (the default value), updates to the display are suppressed while a macro is being run. Operations that typically update the display, such as the Volume Render operation, do not change the display if **Display intermediate steps** is set to False.

To see an individual macro item’s properties, click on the item in the macro tree. The properties appear in the macro property sheet, as shown in [Figure 8-11](#). To change any of the properties, click on a property in the sheet and make the modification you want.

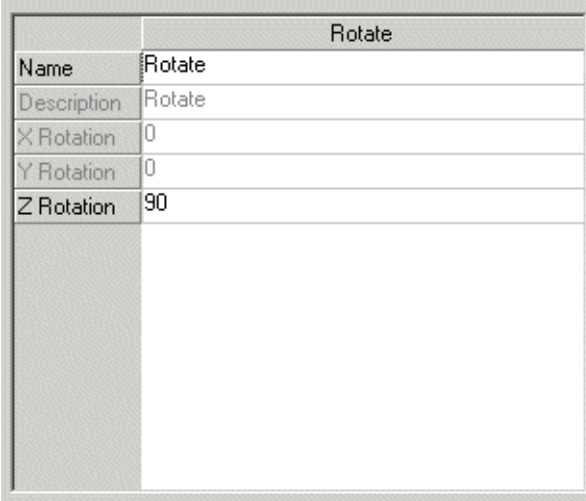

| Rotate      |        |
|-------------|--------|
| Name        | Rotate |
| Description | Rotate |
| X Rotation  | 0      |
| Y Rotation  | 0      |
| Z Rotation  | 90     |

*Figure 8-11: The Macro Editor’s Macro Property Sheet: Macro Item*

You can modify any properties of a macro item except for user-defined properties, which are not available for modification.

## The Source Tree

The source tree (bottom left), as shown in [Figure 8-12](#), contains the following items that you can use for macro creation:

- History items, grouped by tool (see [“History Items”](#) on page 163)
- Visualizations (see [“Visualization Items”](#) on page 166)
- Annotations (see [“Annotation Items”](#) on page 167)
- Macro tool items (see [“Macro Tools Items”](#) on page 168)
- Tool menu items (see [“Tool Menus Items”](#) on page 174)

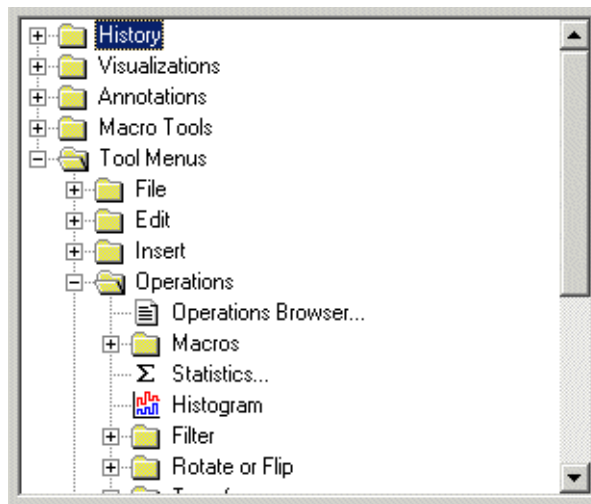

*Figure 8-12: The Macro Editor's Source Tree*

You can use these property settings and operations as a source for macro items. Selecting one of these items displays its properties in the source property sheet next to the tree panel. While the visualizations and annotations cannot be used directly in macros, you can use their properties as the source for macro property settings. The source tree also contains operations for the current tool, in the **Tool Menus** → **Operations** subfolder, which you can use as a source for macro operations.

Clicking on an item in the tree selects the item and displays its property sheet to the right of the tree panel. You cannot multi-select within the tree. Right-clicking within the tree brings up the context menu of available actions (see “[The Menu Bar](#)” on page 152). If you right-click on a tree item, then that item is selected.

## The Source Property Sheet

The source property sheet (bottom right) displays the properties of items in the source tree to its left. As described above, properties can be used as source items for macros.

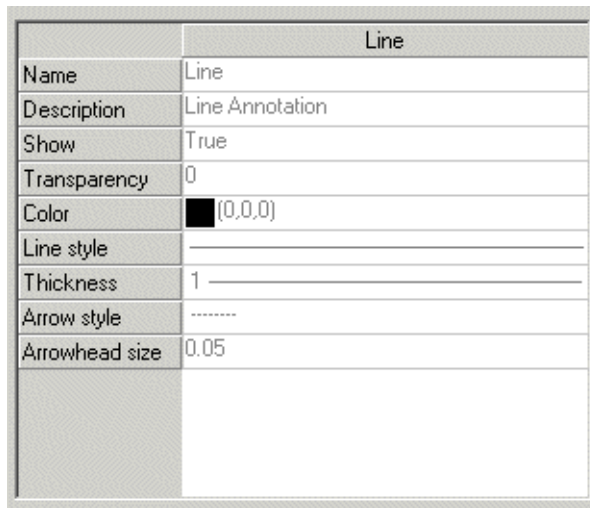

*Figure 8-13: The Macro Editor's Source Property Sheet*

[Figure 8-13](#) shows the properties for the Line operation, found in the source tree's Annotations folder. You can multi-select properties in the sheet. Selected properties may be moved to a macro property setting item. Although all properties in the source property sheet are grayed out (desensitized), you can select them for creation of SetProperty macro items (for more information, see “[SetProperty Settings](#)” on page 162).

### Note

User-defined properties are available only if they are part of a macro recording; they will apply like any other property during playback. You cannot otherwise use a user-defined property (moving, copying, modifying, etc.) in the macros system.

## The Add and Remove Buttons

There are two sets of Add and Remove buttons, one for the source and macro trees and one for the source and macro property sheets. Both sets have similar behavior.

### The Item Add Button

The item Add button (in the left pair) copies items from the History and operations folders up into macros. If a macro folder is selected in the macro tree then the new item is placed at the end of existing items. If a macro item is currently selected in the macro tree, then the new item is added to the macro folder, immediately following the selected macro item. If the top-level Macros folder is selected, then a new macro is created, and the item is placed within it.

With a visualization selected, the Add button adds a ‘Visualization...’ operation to the macro. This item will make a running macro present the Insert Visualization dialog to let you define parameters and insert a new visualization. Note that the **Show Dialog** property is set to True because you must define the parameters interactively, unlike with an Insert Visualization operation that has been recorded or copied from history.

You can select annotations in the source tree to select their properties, but you cannot move the annotations directly up into macros because they require initialization with data. The exception is annotations in the History folder (for more information, see [“Annotation Items”](#) on page 167).

### The Item Remove Button

The item Remove button (in the left pair) removes the selected item or folder from the macro tree.

### The Property Add Button

The property Add button (in the right pair) moves selected properties up into a new or existing SetProperty operation in a macro. Running a macro with a SetProperty operation applies the property setting to the selected visualization, letting you set the specified property on any applicable object.

---

#### Note

Once a property setting is added to a macro, it is no longer tied to a particular visualization type.

---

If you add a desensitized property to a macro item, the property will be sensitized (not grayed out) in the macro property sheet.

If you select an existing SetProperty item in the macro tree, IDL adds properties to it instead of creating a new SetProperty item.

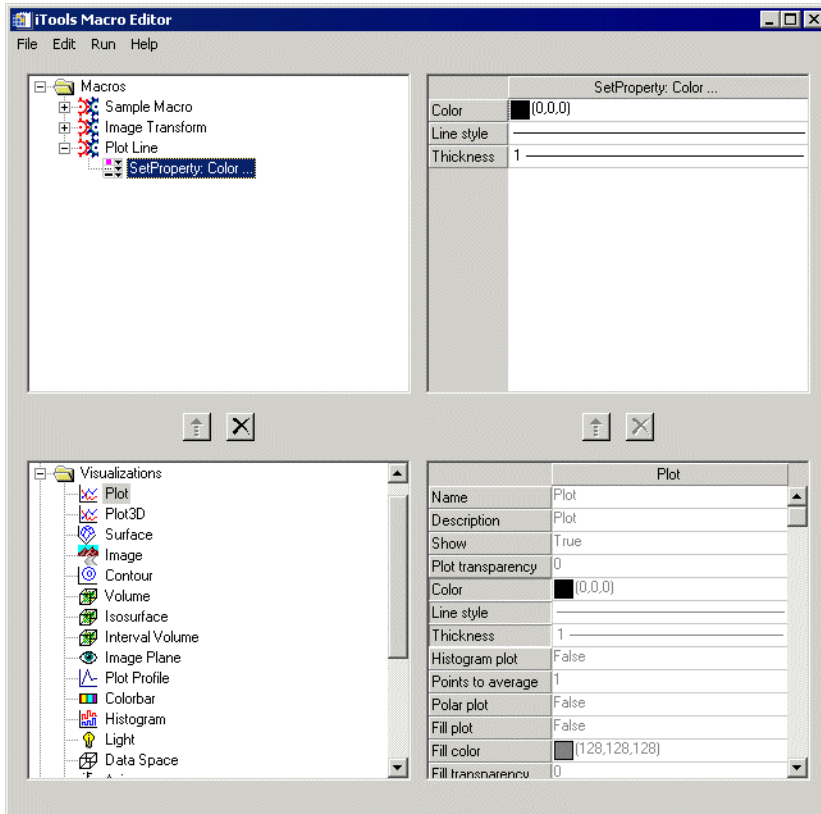

Figure 8-14: An Example Using the Property Add Button

Figure 8-14 shows a SetProperty macro item created by selecting the Plot visualization in the source tree and three properties (Color, Line Style, and Thickness) in the source property sheet. The property Add button copied the desired property settings up into a SetProperty macro item containing all three properties.

### The Property Remove Button

The property Remove button (in the right pair) removes any selected properties from SetProperty items. It is not enabled for other types of macro items.



# Understanding Items in the Macro Editor

In the Macro Editor, you work with two main groups of items: those that make up a macro (items in the macro tree) and those that you use to create a macro (items in the source tree).

## Macro Items

Macro items are the elements that make up a macro, namely operations and property settings. You insert them into a macro either during recording or, in the Macro Editor, by moving them from the source tree up into the macro tree. The properties of a selected macro item appear in the macro property sheet.

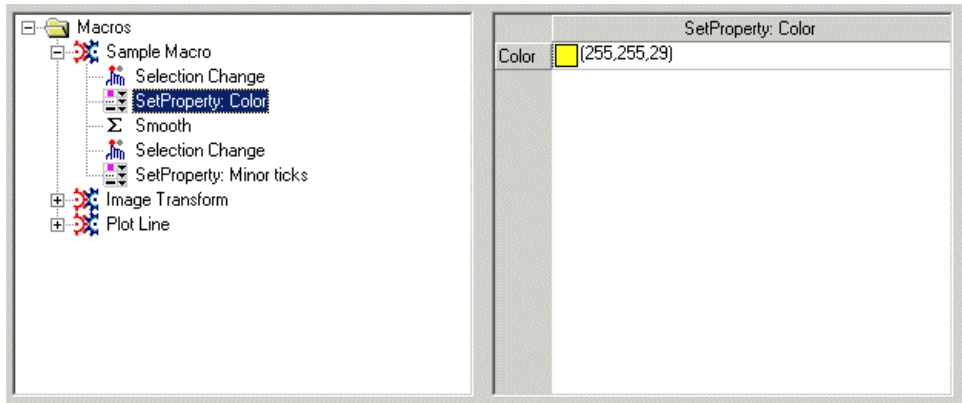

Figure 8-15: Macro Items in the Macro Editor

Figure 8-15 shows the macro items in the Sample Macro macro, both operations (Selection Change and Smooth) and property settings (SetProperty: Color, SetProperty: Minor ticks). The first SetProperty item is selected to show the property value (Color) that it will set on the selected object during playback.

## Operations

Operations are the actions that you want the macro to perform on the selected object or objects, such as inserting a plot legend or applying a convolution filter. You can modify an operation's properties to customize it.

Some operations have the **Show dialog** property set to False by default when the operation is added to a macro, either by recording or in the editor. This setting lets the

operation run without displaying its dialog when the macro is run. In this case, any operation properties will be obtained from the saved macro item and used during playback. You can alter the value of this property to allow customization of operation properties during playback. If the **Show dialog** property of the macro item is set to True, then during macro playback the operation's dialog will be displayed, letting you alter any operation properties. Once the dialog is closed, the execution of the macro will continue.

## SetProperty Settings

SetProperty settings contain only the properties being modified, which will apply to the currently active object during macro playback. They do not contain the **Name** and **Description** properties typically displayed for an object because the property can apply to whatever object is selected (that is, these fields are no longer tied to a certain type). However, if the name and description properties are selected in the editor or modified in a recording, the SetProperty item will display these properties as expected.

You can modify properties in the Macro Editor to customize your macros.

## Source Items

This group consists of history items and four folders of operation items that you can use in macro creation: Visualizations, Annotations, Macro Tools, and Tool Menus. The items in all five groups are also available as a source for property settings to be added to a SetProperty macro item.

## History Items

The History folder in the source tree, shown in [Figure 8-16](#), contains history items. The properties of a selected history item appear in the source property sheet.

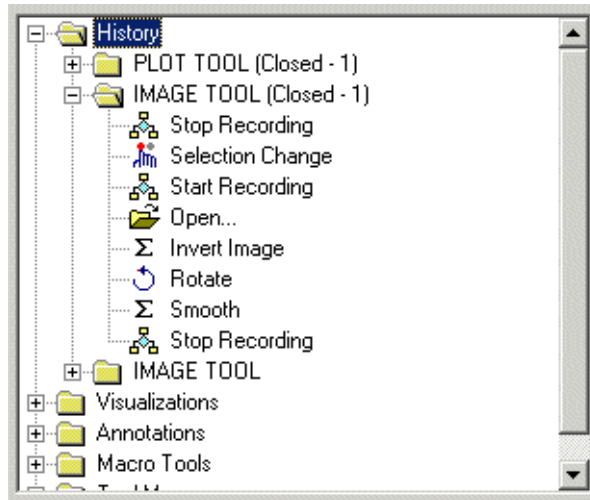

*Figure 8-16: The Macro Editor's History Folder*

The History folder records actions that occur in an iTool. The history items are grouped into folders for each tool in current or past use, with each folder named by its tool identifier (e.g., 'PLOT TOOL' for an open iPlot tool). History items will continue to be added to history folders for the duration of the iTools session. This sequence of history items thus represents an audit trail for actions taken in a tool. It also serves as a source for the creation of macros.

### Note

The History folder is cleared at the end of an iTools session (through the `itreset` command or by exiting IDL).

When you change a property value in an iTool, IDL creates a corresponding history item. The name of the property being changed is appended to the name of that item (e.g., 'SetProperty: Color' instead of simply 'SetProperty'). When you select or deselect an object in an iTool, the name of the object selected or deselected is concatenated to the name of that item (e.g., 'Selection Change: Axes'). In both cases, this additional information in the audit trail can show which properties were changed or which objects were selected or deselected.

**Note**

The object name is specified on history items but not on macro items, because when you run the macro, it might be operating on different objects based on the current selection. For more information, see [“Selection Changes”](#) on page 177.

**Items from Closed Tools**

When a tool is closed, the name and identifier of the history folder changes to indicate that the tool has been closed. The string ‘(Closed-N)’ is appended to the name of the history folder, where *N* is an integer starting at 1 and is incremented each time the tool with the same identifier is closed. After a tool is closed and the History folder renamed, creation of another tool of the same type causes the creation of a new tool with the name of the tool identifier. Actions in this tool would be recorded in a history folder named by the simple tool identifier.

For example, the following sequence creates the History folder items shown in [Figure 8-17](#):

1. Start iImage, open an image, and apply the Smooth operation.
2. Close iImage.
3. Start iImage, open an image, and apply the Median operation.
4. Close iImage.
5. Start iImage, open an image, and apply the Convolution operation.
6. Keep iImage open, start a new iImage tool, open an image in the new iImage, and apply the Dilate operation to it.
7. Close the second (newer) iImage.
8. Open the Macro Editor from the existing iImage tool.

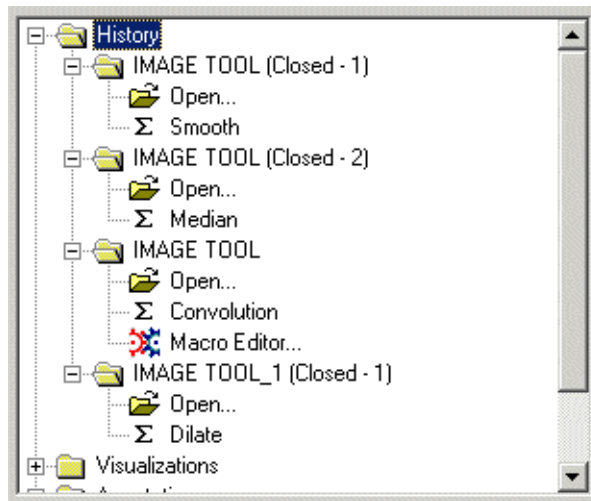

Figure 8-17: A History Example with Open and Closed Tools

## Run Macro Items

The Run Macro operation is itself an operation that will show up in the history and can be added to a macro. Using the Run Macro macro item lets you nest macros for grouping of common tasks.

If a macro has been run, you can copy a Run Macro item to a macro from the History folder. You can also add it from the **Tool Menus** → **Operations** → **Macros** subfolder in the source tree. The item contains a **Macro name** property to allow specifying the name of the macro to run. If you copy the item from history, this property is set to the name of the macro that was run, but you can set it to the name of any macro. If you add the item from the **Tool Menus** → **Operations** → **Macros** subfolder, the macro name property will be blank and should be set to the name of the desired macro to run. If you try to run a macro containing a nested Run Macro operation, you will get an error dialog if the macro name is invalid or the macro cannot be found.

## Visualization Items

The Visualizations folder, shown in [Figure 8-18](#), contains the visualizations that you can use in the iTools.

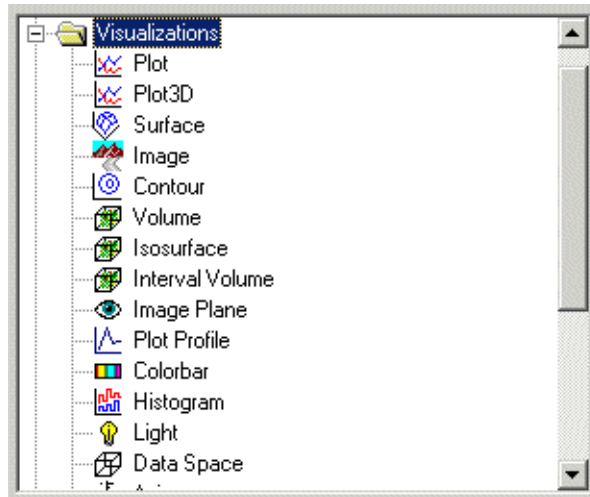

*Figure 8-18: The Macro Editor's Visualizations Folder*

Visualizations require data for their creation, and so you cannot copy default items from this folder directly into a macro. When you add a visualization to a macro from the Visualizations folder, using the item Add button, the ‘Visualization...’ operation appears as a macro item with the **Show dialog** property set to True because you must define the visualization parameters interactively to define the data. If you want to add a visualization without having to show the **Insert Visualization** dialog, add an Insert Visualization operation from the History folder because that visualization already contains data.

You can select visualization items in the source tree to select their properties and add them to a macro (e.g., while editing a recorded macro, you could add a SetProperty item that changes the isovalue of an isosurface).

## Annotation Items

The Annotations folder, shown in [Figure 8-19](#), contains the operations that create text, line (including geometric shapes), and legend annotations in a tool.

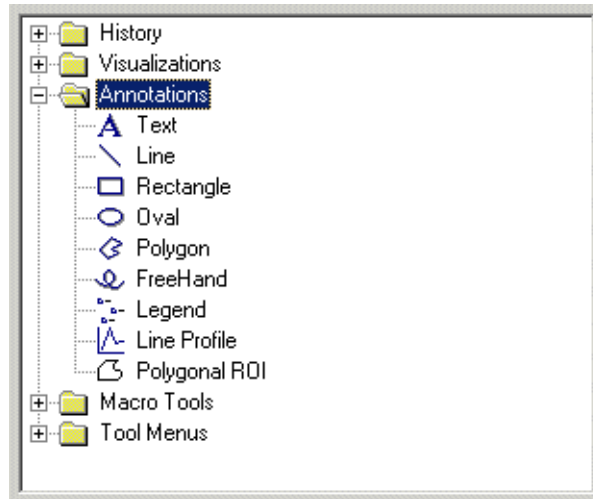
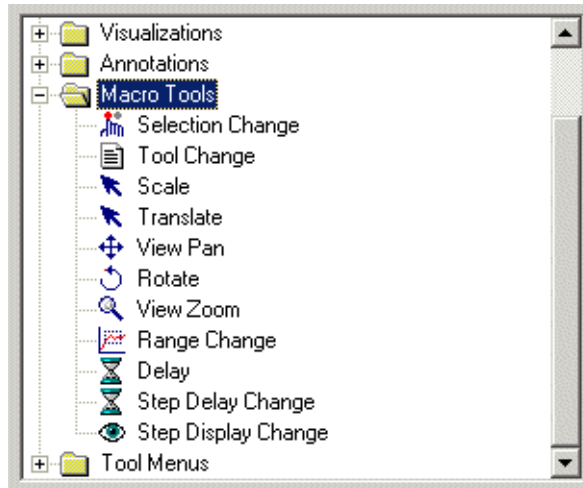

*Figure 8-19: The Macro Editor's Annotations Folder*

Annotations require data for their creation, and so default items from those folders cannot be copied directly to a macro. You can select annotations in the source tree to select their properties and add them to a macro (e.g., a SetProperty item that changes the caption of a text annotation), but you cannot move these items directly up into macros because they require initialization with data. If you want to add an annotation directly, you can only add an **Insert Annotation** operation from the History folder because that annotation already contains data.

## Macro Tools Items

The Macro Tools folder, shown in [Figure 8-20](#), contains operations that are not in the standard menu system. You can use these items to build macros.



*Figure 8-20: The Macro Editor's Macro Tools Folder*

The operations in this folder deal with selection changes, tool changes, and the Scale, Translate, View Pan, Rotate, View Zoom, Range Change, Delay, Step Delay, and Step Display Change manipulations.

For information on selection and tool changes, see [“Making Selection and Tool Changes”](#) on page 176.

### Scale Operation Item

The Scale operation stores the scaling factors from an interactive scale manipulation.

[Table 8-4](#) shows the Scale operation's properties and values.

| Property    | Value   |
|-------------|---|
| Description | Operation description, set by default to Scale                  |
| X Scale     | Factor to scale the selected object's data in the $x$ direction |

*Table 8-4: The Scale Operation's Property Values*



| Property | Value   |
|----------|---|
| Y Scale  | Factor to scale the selected object's data in the y direction |
| Z Scale  | Factor to scale the selected object's data in the z direction |

*Table 8-4: The Scale Operation's Property Values (Continued)*

Note that you could have unpredictable behavior if you modify those properties in the Macro Editor and then run the macro containing the modified operation (e.g., an object scaled further than desired and thus obscuring important details). Be careful with estimating these values.

### Translate Operation Item

The Translate operation stores the translation in pixels in the  $x$  and  $y$  directions from an interactive translate manipulation. This operation lets the macro system record and play back movements made with the Translate manipulator from the iTools toolbar (the Arrow icon).

Table 8-5 shows the Translate operation's properties.

| Property      | Value   |
|---------------|---|
| Description   | Operation description, set by default to Translate                |
| X Translation | Number of pixels to move the selected object in the $x$ direction |
| Y Translation | Number of pixels to move the selected object in the $y$ direction |

*Table 8-5: The Translate Operation's Property Values*

Because the  $[x, y]$  translation is relative to the selected object's current position, not absolute within an iTool view, you could have unpredictable behavior if you modify those properties in the Macro Editor and then run the macro containing the modified operation (e.g., an object moving out of view). Be careful with estimating these values.

### View Pan Operation Item

The View Pan operation stores the movement in pixels in the  $x$  and  $y$  directions from an interactive view pan manipulation. This operation lets the macro system record and play back movements made with the View Pan manipulator from the iTools toolbar (the Hand icon).

Table 8-6 shows the View Pan operation's properties and values.

| Property    | Value  |
|-------------|--|
| Description | Operation description, set by default to View Pan          |
| X Pan       | Number of pixels to pan the view in the <i>x</i> direction |
| Y Pan       | Number of pixels to pan the view in the <i>y</i> direction |

*Table 8-6: The View Pan Operation's Property Values*

Note that you could have unpredictable behavior if you modify those properties in the Macro Editor and then run the macro containing the modified operation (e.g., a view panned further than desired and thus obscuring important details). Be careful with estimating these values.

### Rotate Operation Item

The Rotate operation stores the rotation angles from an interactive rotate manipulation. This operation lets the macro system record and play back movements made with the Rotate manipulator from the iTools toolbar.

Table 8-7 shows the Rotate operation's properties and values.

| Property    | Value  |
|-------------|--|
| Description | Operation description, set by default to Rotate                      |
| X Rotation  | Angle to rotate the selected object about the <i>x</i> -axis         |
| Y Rotation  | Angle to rotate to move the selected object about the <i>y</i> -axis |
| Z Rotation  | Angle to rotate to move the selected object about the <i>z</i> -axis |

*Table 8-7: The Rotate Operation's Property Values*

Because the [*x*, *y*, *z*] rotation is relative to the selected object's current position, not absolute within an iTool view, you could have unpredictable behavior if you modify those properties in the Macro Editor and then run the macro containing the modified operation (e.g., an object rotating further than desired and thus obscuring important details). Be careful with estimating these values.

## View Zoom Operation Item

The View Zoom operation stores the zoom percentage from an interactive zoom manipulation. This operation lets the macro system record and play back movements made with the View Zoom manipulator from the iTools toolbar.

Table 8-8 shows the View Zoom operation's properties and values.

| Property        | Value   |
|-----------------|---|
| Description     | Operation description, set by default to Zoom |
| Zoom Percentage | Zoom percentage on the selected object        |

*Table 8-8: The View Zoom Operation's Property Values*

Because the zoom percentage is relative to the selected object's current position, not absolute within an iTool view, you could have unpredictable behavior if you modify this property in the Macro Editor and then run the macro containing the modified operation (e.g., an object zooming further in than desired). Be careful with estimating this value.

## Range Change Operation Item

The Range Change operation stores the changes to the dataspace range from interactive range zoom, range pan and range box manipulators. This operation lets the macro system record and play back changes made with the Data Range manipulator from the iTools toolbar (the graph icon).

Table 8-9 shows the Range Change operation's properties and values.

| Property    | Value   |
|-------------|---|
| Description | Operation description, set by default to Range Change |
| X Minimum   | Minimum value for the $x$ coordinate of the data set  |
| X Maximum   | Maximum value for the $x$ coordinate of the data set  |
| Y Minimum   | Minimum value for the $y$ coordinate of the data set  |
| Y Maximum   | Maximum value for the $y$ coordinate of the data set  |
| Z Minimum   | Minimum value for the $z$ coordinate of the data set  |

*Table 8-9: The Range Change Operation's Property Values*

| Property  | Value  |
|-----------|--|
| Z Maximum | Maximum value for the z coordinate of the data set |

*Table 8-9: The Range Change Operation's Property Values (Continued)*

Note that you could have unpredictable behavior if you modify those properties in the Macro Editor and then run the macro containing the modified operation (e.g., the data range scaled up or down further than desired and thus obscuring important details). Be careful with estimating these values.

### Delay Operation Item

The Delay operation can be added to a macro to cause a discrete delay at a particular place in a macro. The **Delay (seconds)** property of the operation allows setting a value in seconds to delay macro execution. This specific delay allows for a custom delay at a specified location in a macro, in contrast to the macro's **Step delay** property, which causes a delay between each step of the macro (see [“The Macro Property Sheet”](#) on page 154).

#### Note

When you are using the **Macro Controls** dialog to step manually through a macro, the delay is not applied. For more information on this dialog operation, see [“Step”](#) on page 148.

[Table 8-10](#) shows the Delay operation's properties and values.

| Property        | Value   |
|-----------------|---|
| Description     | Operation description, set by default to Delay.   |
| Delay (seconds) | Value, in seconds, to delay. The default value is 0.0. The minimum value is 0.0. There is no maximum value or step. |

*Table 8-10: The Delay Operation's Property Values*

### Step Delay Change Operation Item

The Step Delay Change operation can be added to a macro to change the step delay during macro execution. The Step Delay property of the operation allows setting a value in seconds to delay between macro items.

This step delay remains in place until the end of macro execution or until another Step Delay Change operation is encountered. The Step Delay value from this

operation is not saved in the Step Delay property of the macro containing this operation. The step delay of the Step Delay Change operation is a temporary override of the macro's Step Delay property.

This delay allows setting the step delay for part of a macro. You can use several Step Delay Change operations within a macro to make different parts of a macro have delays of different length. If you want a discrete delay in a single location, use the Delay operation. For more information, see “[Delay Operation Item](#)” on page 172.

### Note

When you are using the **Macro Controls** dialog to step manually through a macro, the step delay is not applied. For more information on this dialog operation, see “[Step](#)” on page 148.

[Table 8-11](#) shows the Step Delay Change operation's properties and values.

| Property             | Value  |
|----------------------|--|
| Description          | Operation description, set by default to “Change the macro step delay.”  |
| Delay mode           | Indicates which delay to use. If <b>Delay mode</b> is set to “Use specified delay,” the <b>Step delay (seconds)</b> value becomes the current step delay. If <b>Delay mode</b> is set to “Use macro folder delay,” the step delay is retrieved from the macro applied to the current step delay. |
| Step delay (seconds) | Value, in seconds, to delay. The minimum value is 0.0, the maximum value is 60.0, and the default step is 0.01.  |

*Table 8-11: The Step Delay Change Operation's Property Values*

### Step Display Change Operation Item

The Step Display Change operation can be added to a macro to toggle the visibility of intermediate steps during macro execution.

The setting for the **Display intermediate steps** property remain in place until the end of macro execution or until another Step Display Change operation is encountered. The **Display intermediate steps** value from this operation is not saved in the corresponding property of the macro containing this operation. The setting is instead a temporary override of the macro's **Display intermediate steps** property.

This property allows setting the visibility of intermediate steps for part of a macro. You can use several Step Display Change operations within a macro to make

different parts of a macro show intermediate steps while other parts do not update the display.

### Note

An update of the display is always done at the completion of macro execution.

Table 8-12 shows the Step Display Change operation's properties and values.

| Property                   | Value  |
|----------------------------|--|
| Description                | Operation description, set by default to "Change the macro step display"                                     |
| Display intermediate steps | Indicates whether to display intermediate steps, set by default to False (do not display intermediate steps) |

Table 8-12: The Step Display Change Operation's Property Values

## Tool Menu Items

The Tool Menu folder, shown in Figure 8-21, contains the operations from the iTools' menus.

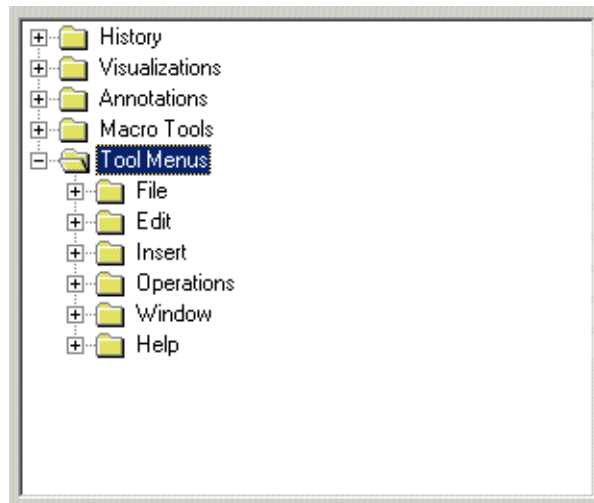

Figure 8-21: The Macro Editor's Tool Menu Folder

You can use items from the Tool Menus folder as a source for property settings or as a direct source for macro items. When you add one of these operations to a macro (e.g., to change the view layout of an iTool), you can modify the resulting macro item's property values to customize the actions taken by the operation when the macro runs.

**Note**

---

These operations are for the current tool. Therefore, this folder is no longer available if all tools are closed.

---

# Making Selection and Tool Changes

You can change the selection of objects and even iTools in the course of a macro, to let you apply macro items to different objects within and across iTools. You can add these operations during macro recording or by using the Macro Editor, where you can find the selection change operations in the Macro Tools folder of the source tree.

## Macro Type Based on Recording Selection

What you have selected when you start recording a macro gives rise to two general types of macros, where one of the following states is true:

- A visualization or annotation selected
- No visualization or annotation selected (e.g., a view selected instead)

In the first case, the macro's first item is a Selection Change operation with the **Selection type** property set to Existing Selection. This item represents the selection active when recording starts. When you play back the macro, it begins to apply its items (operations, property settings, or both) to the object that is selected when playback begins.

In the second case, the macro's first item is a Selection Change operation with the **Selection type** property set to No Items (De-Select All). When you play back the macro, the current selection is cleared before additional macro items are processed. You can create this type of macro if you want it to work on only specific objects or selections. The macro would typically clear the selection and then select the particular objects and then operate on them.

## About Containers

The following discussion on the creation of these change operations and the properties of the operation introduces the concept of a container and position in the container. These concepts apply to both selection and tool changes, with some differences in the details.

For both changes, the term *container* is a generic term for one of the iTools objects that contains other objects. In relation to selection changes, the commonly referenced containers are the Data Space, the Annotation Layer, and the Window.

The Data Space contains visualizations that can be referenced by their position in the container. If you use the Visualization Browser to look at the visualization hierarchy, you can see that the order of the visualizations within the tree view represents their



positions in the container. This arrangement is also true of annotations within the Annotation Layer.

You can see the Window in the Visualization Browser as well. The Window is a container that holds Views, and the order of Views within the Window folder of the Visualization Browser is equivalent to the Views' positions in the container.

In relation to tool changes, the container is the current iTools session, containing all the tools. The tools container contains the individual tools, which can be referenced by their zero-based position in the container. The order of the tools is determined by their order of creation.

## Selection Changes

The Selection Change operation is a macro item that can alter the current selection so that subsequent macro items are applied to different objects. During the recording of a macro, the selection change operations are added to the macro when the selection is changed interactively. In addition, when you start recording a macro, a Selection Change operation is added to reflect the current state of the selection (for more information, see [“Macro Type Based on Recording Selection”](#) on page 176).

### Adding a Selection Change Operation

You can add a Selection Change operation either when you start recording a macro or during recording.

A Selection Change operation is inserted during recording if the selection is changed interactively. In this case, the type of the selection change operation is set to Position in Container. The values of the Container and Item Identifier properties are set. The value of the Selection Mode property is set to the applicable value of ['New Selection', 'Add to selection', 'Remove from selection'].

As with other operations, you can modify and delete the Selection Change operation by using the Macro Editor. You can also add the operation from the Macro Tools folder in the source tree.

## Selection Change Operation Properties

Figure 8-22 shows a Selection Change operation's property sheet.

| Selection Change      |                    |
|-----------------------|--------------------|
| Description           | Selection Change   |
| Selection type        | Existing Selection |
| Selection mode        | New Selection      |
| Container             |                    |
| Item identifier       |                    |
| Position in container | 0                  |

Figure 8-22: The Selection Change Operation's Property Sheet

The **Description** property is set by default to Selection Change.

The **Selection type** property indicates the selection upon which the macro will act when you run it. This property can have the following values:

| Property Value        | Description  |
|-----------------------|--|
| Existing Selection    | Applies macro to the current selection.                                      |
| Position in Container | Applies macro to the object indicated by the Position in Container property. |
| All in Container      | Applies macro to all objects in the container.                               |

Table 8-13: The Selection Type Property Values

| Property Value          | Description   |
|-------------------------|---|
| Next in Container       | Applies macro to the next object in the container based on the currently selected object or objects in the container. If multiple objects in the container are selected, the object with the highest position index is used as the starting point from which to determine the next in container. If the currently selected object is the last in the container, this operation wraps to the beginning when selecting the next in container.       |
| Previous in Container   | Applies macro to the previous object in the container based on the currently selected object or objects in the container. If multiple objects in the container are selected, the object with the lowest position index is used as the starting point from which to determine the previous in container. If the currently selected object is the first in the container, this operation wraps to the end when selecting the previous in container. |
| By Identifier           | Applies macro to the object indicated by the Item Identifier property.  |
| All Items               | Applies macro to all items in all containers.   |
| No Items (Deselect All) | Applies macro to no items (requires a Selection Change operation in the macro to select an object).   |

*Table 8-13: The Selection Type Property Values (Continued)*

As [Table 8-13](#) indicates, several Selection Change properties deal with containers (for more information, see [“About Containers”](#) on page 176). For example, if the **Container** property is set to Data Space, a Selection Change operation with a Selection Type property of All in Container selects all visualizations.

The **Selection mode** property indicates the selection upon which the macro will act when you run it. This property can have the following values ([Table 8-14](#)):

| Property Value   | Description                              |
|------------------|--|
| New Selection    | Makes the current object the selection   |
| Add to Selection | Adds the current object to the selection |

*Table 8-14: The Selection Mode Property Values*

| Property Value        | Description                                   |
|-----------------------|---|
| Remove from Selection | Removes the current object from the selection |

*Table 8-14: The Selection Mode Property Values (Continued)*

The **Container** property defines the container within which the Selection Change operation will act (e.g., Window/View\_1/Visualization Layer/Data Space for the first View's data space).

The **Item identifier** property names the object upon which the Selection Change operation will act (e.g., View\_1 for the first View in the Window).

The **Position in container** property identifies the selected object's position by number (e.g., 0 for the first item in the Visualization Layer).

## Tool Changes

The Tool Change operation represents a macro item that sets the current tool so that subsequent macro items are applied in a different tool. During macro recording, a Tool Change operation is added when the currently selected tool is changed interactively. Note that when the tool selection changes because of an operation such as Histogram rather than changing interactively, a Tool Change operation is not added because it would be redundant (that is, the tool change is part of such an operation).

### Adding a Tool Change Operation

You can add a Tool Change operation either when you record a macro or by adding the operation from the Macro Editor's source tree, in the Macro Tools folder.

If the operation is added during recording, the **Change type** property is set to By Identifier, and the identifier and position values are set. If it is added through the Macro Editor, only the **Change type** and **Position in container** properties are set (to By Identifier and 0, respectively).

As with other operations, you can modify and delete the Tool Change operation by using the Macro Editor.

## Tool Change Operation Properties

Figure 8-23 shows a Tool Change operation's property sheet.

| Tool Change           |               |
|-----------------------|---------------|
| Description           | Tool Change   |
| Change type           | By Identifier |
| Tool identifier       |               |
| Position in container | 0             |

Figure 8-23: The Tool Change Operation's Property Sheet

The **Description** property is set by default to Tool Change.

The **Change type** property indicates the kind of tool change that the macro will perform when you run it. This property can have the following values (Table 8-15):

| Property Value        | Description  |
|-----------------------|--|
| By Identifier         | Change selection to the tool indicated by the Tool Identifier property   |
| Position in Container | Change selection to the tool indicated by the Position in Container property   |
| Next in Container     | Change selection to the next tool in the container. If the current tool is the last in the container, the search for the next tool will wrap to the beginning of the container, and the first tool in the container will become the current tool |

Table 8-15: The Change Type Property Values

| Property Value        | Description  |
|-----------------------|--|
| Previous in Container | Change selection to the previous tool in the container. If the current tool is the first in the container, the search for the next tool will wrap to the end of the container, and the last tool in the container will become the current tool |

*Table 8-15: The Change Type Property Values (Continued)*

Recall that in terms of tool changes, the container means simply the current iTools session, encompassing all tools. For more information, see [“About Containers”](#) on page 176.

The **Tool identifier** property names the tool to which the Tool Change operation will change (e.g., ‘IMAGE TOOL’ for an iImage tool). This property is used only if the value of the Change Type property is By Identifier; otherwise, it is ignored.

The **Position in container** property identifies the tool to which the Tool Change operation will change by number (e.g., 0 for the first tool in the session). This property is used only if the value of the **Change type** property is Position in Container; otherwise, it is ignored.

# Importing and Exporting Macros

You can import a macro from a file by selecting **File** → **Import** from the Macro Editor, which opens a dialog that lets you select one or more macro files to import. Macro files are IDL SAVE files created by exporting an existing macro.

---

**Note**

Macros created in future versions of IDL might contain features not present in the current release and might not behave as designed. Users will be warned if they are importing macros from a future version of IDL.

---

You can export a macro to a file by selecting **File** → **Export** from the Macro Editor. The filename that you specify will be used to create an IDL SAVE file containing the macro. The macro to be saved is specified by either the macro folder selected explicitly or the macro folder containing the selected macro item.

---

**Note**

If a Run Macro operation is in the macro being exported, you must export the macro to which that operation refers as well, to ensure proper playback behavior of the original exported macro.

---







# Chapter 9

# Working with Styles

This chapter introduces IDL iTool styles and discusses the following related-tasks:

---

|                        |     |                                      |     |
|------------------------|-----|--------------------------------------|-----|
| What Are Styles? ..... | 186 | Editing Styles .....                 | 200 |
| Creating Styles .....  | 188 | Setting the Default Style .....      | 203 |
| Applying Styles .....  | 194 | Importing and Exporting Styles ..... | 204 |
| Editing Styles .....   | 200 |                                      |     |

# What Are Styles?

iTool *styles* provide a convenient way to store and apply a set of properties to items in your iTool. While modifying individual property items within a style has the same effect as creating a new style that sets the same properties, a new style can be created, customized, and applied in a current session or in later sessions. Styles provide a shortcut mechanism that allows you to quickly apply groups of properties to your visualization, and to automatically alter the properties of newly-created visualizations. Styles are available across all iTools. For example, a style created in the iPlot tool will also appear as a Style selection when working in the iImage tool. However, only relevant style properties are applied to a selected visualization. Property settings for absent visualization items in the style are ignored.

Nearly all properties can be stored in styles. The only exception to this are user-defined properties (such as the color look-up table associated with an image). Individual property styles are never global, that is, the color property associated with a plot object applies only to a plot, and does not affect the color property of a surface. Nevertheless, a style can easily be created to set the color property for these individual visualization types.

When applied, styles are not permanently linked to a visualization. In other words, the visualization is exactly the same as it would be if individual properties had been set instead of the style being applied. Changes to the style are not automatically updated in the visualization unless the style is re-applied to the visualization. All of these characteristics ensure that when an iTool is saved and then shared with any other users, it will display identically. There is no need to send an associated style file.

---

**Note**

You can share styles with other users. See [“Importing and Exporting Styles”](#) on page 204 for details.

---

## Type of Styles

Style information is stored in one or more style files located on your system. The two classes of style files are System Styles and Personal Styles:

- **System Styles** — IDL System Styles are pre-loaded in your IDL distribution. IDL’s supplied System Styles are:
  - **IDL Classic** - This System Style contains IDL Direct Graphics’ common black background with white text and white linestyle.

- **IDL Standard** - This System Style is the iTools default and contains a white background with black text and black lines.
- **Personal Styles** — IDL Personal Styles are styles which you create. These are stored inside your `.idl` directory. When you create a new style within an iTool, it is automatically saved in this location.

---

**Note**

Style information is stored independently of any iTool. Styles are never automatically saved by simply making style changes in an iTool. They must always be saved explicitly.

---

## Applying a Style

As mentioned, System Styles exist in your IDL distribution and are ready to use immediately (creating your own new Personal Styles is discussed at-length in the [Creating Styles](#) section). From an iTool window, in order to apply a style, select **Edit** → **Style** → **Apply Style...** or **Edit** → **Style** → **Style Editor...**

For more in-depth information on style application, see “[Applying Styles](#)” on page 194.

# Creating Styles

There are two ways a new Personal Style can be created. You can use the iTool's Style Editor or you can select one or more visualizations within your iTool view (or the view itself) and create a new style. Both of these options are discussed here.

## Creating a Style from the Current Visualization

You can create a new style by selecting one or more visualization objects within the view (or by selecting the entire view). A new style created in this manner will contain all property settings of the selected objects (or all objects in the view if nothing was selected).

### Creating a Style From All Items in a View

The following example shows how to create a new style from all items in a view:

1. From the IDL Command Line, plot a simple line graph within iPlot:

```
iPlot, RANDOMU(seed, 30)
```

2. From the iPlot window, select one or more visualization objects or the entire view within the window. Then select: **Edit** → **Style** → **Create Style from Selection...**
3. Enter a name for your new style (in this example it is named **MyNewStyle1**) in the **Create Style from Selection** dialog shown in the following figure.



Figure 9-1: Create Style from Selection Dialog (MyNewStyle1 Style)

4. Now you can select between creating the new style using the selected items or using all items in the view. In this instance, choose **Create using all items in view**.

5. Select **OK** and the **iTools Style Editor** appears.
6. You can now expand the newly named style to view its properties. Under **MyNewStyle1**, select **Plot** and change the **Color** to your preference as shown here:

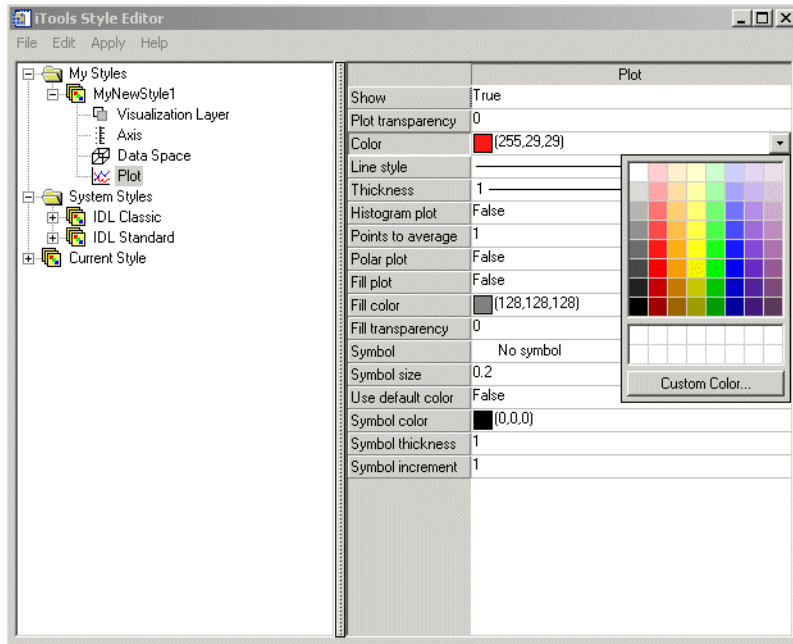

*Figure 9-2: Selecting Background Color*

7. Change the **Symbol** to **Asterisk**.
8. Now, from the Style Editor window, select the **Axis** object and change the color.
9. Select **File** → **Save** to save changes to **MyNewStyle1**.
10. Next, from the iPlot window, select **Edit** → **Style** → **Apply Style** and select **MyNewStyle1** from the **Apply Style** dialog that appears. Your new style, which contains changes to your line style color, plot symbol type (asterisks) and color of plot axes, is applied to the plot object.

**Note**

If multiple items of the same class are within a container (e.g. the axes container), the first one within the container will be used when creating the style.

## Creating a Style From Selected Items

The following example shows how to create a new style from selected items within an iTool view:

1. From your existing iPlot window, select the text annotation tool (the letter A on the top of the window on the annotation toolbar).
2. Click anywhere in the window you wish to add a title for your plot. Type in “My Plot”.
3. Double-click on your new text annotation, and the Visualization Browser appears. Here you can edit the properties of your annotation. Change the text font, size, and color.
4. With your text annotation “My Plot” is selected (a box appears around the title when selected), select **Edit** → **Style** → **Create Style from Selection...**
5. Enter a name for your new style in the **Create Style from Selection** dialog shown in the following figure.

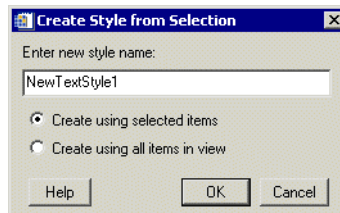

*Figure 9-3: Create Style from Selection Dialog (NewTextStyle1 Style)*

6. Name your new style **NewTextStyle1**. Now you can select between creating the new style using the selected items or using all items in the view. In this instance, choose **Create using selected items**.
7. Select **OK** and the **iTools Style Editor** appears.
8. Since we have already set our text options as we want them to appear, you can close the **Style Editor**.

9. Now open a new iPlot window and add a new title (for example, “My New Plot”) using the text annotation tool.
10. Select **Edit** → **Style** → **ApplyStyle** and select to apply **NewTextStyle1**. This applies the personal text style to the new annotation.

For details on applying a style to selected items or to all items within a view, or when launching an iTool, see “[Applying Styles](#)” on page 194. For information on modifying existing styles, see “[Editing Styles](#)” on page 200.

---

**Note**

If nothing is currently selected, then the Visualization Layer within the current view will be used when creating the style.

---

## Creating a Style from Multiple Selected Items

Within an iTool view, you can select one or more visualization objects or annotations (or a combination of the two) to be included in a new Personal Style. To select one object or annotation simply click on the item. To select multiple items, select the first and then, holding down the **Ctrl** key, click on the other items.

Changes to the properties of the object or annotation can be made prior to creating a new style (by double-clicking on the item and altering the properties in the Visualization browser) or after creating a new style (within the iTools Style Editor).

---

**Note**

If multiply items of the same class are selected (say two axes), the first one selected will be used when creating the style.

---

## Creating a New Style from the Style Editor

The Style Editor can be used to manually create a new style and specify the values of individual properties. Options are available in the Style Editor to duplicate existing styles, or to copy items from one style to another.

The following example shows how to create a new style using the iTool’s Style Editor:

1. First, open any iTool window and import some data.
2. From the iTool window, select **Edit** → **Style** → **Style Editor...** The iTools Style Editor window appears.

3. You will see *My Styles*, *System Styles*, and *Current Style* listed. Select *Current Style* and right-click and select **Duplicate**. A **Copy of Current Style** appears under *My Styles* and is named **Copy of Current Style**.

**Note**

---

From the iTool window you can also select **File** → **New Style**.

---

4. Select the **Copy of Current Style** and rename it to your desired name in the right-hand side of the Editor.

**Note**

---

To avoid confusion, styles should be given unique names. You may not name a style the same name as an IDL system style.

---

5. You are now able to make any changes within the new style by expanding the new style's object tree and making changes to the properties of individual visualization objects.
6. When finished, select **File** → **Save**.

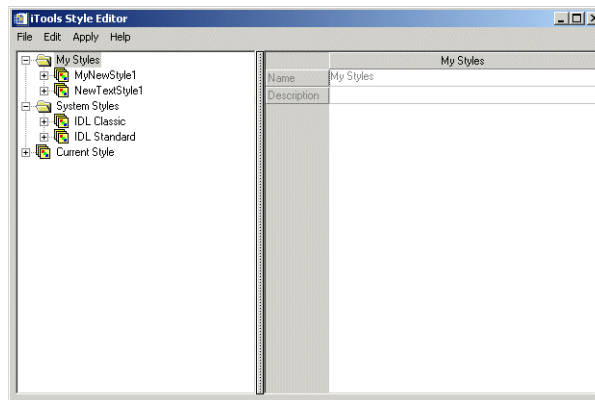

Figure 9-4: The iTool's Style Editor

**Note**

---

For more information on how to populate the new style with properties, see [“Editing Styles”](#) on page 200.

---



## Working with the Current Style

The Current Style contains the properties that will be used to create new visualizations in the current tool. The Current Style can be found in the iTools Style Editor. The Current Style can be modified by:

- Changing individual property values. These changes can be copied into another style, or applied to a visualization when the Current Style item is selected.
- Updating the Current Style when applying style modifications. See [“Applying Styles”](#) on page 194 for details.
- Updating the Current Style from a style in the Style Editor. Select a Personal or System style and select **Update Current Tool Style** from the context menu or **Apply** menu.

---

### Note

The Current Style is not saved between IDL sessions or between iTools. Because of this, one use of the Current Style can be as a practice area to define new styles. Changes can be made to the Current Style and then used to create your desired style. You can then save this new style under a new name. The new style can be set as the "Default style" in the Preferences. For more information on setting a default style, see [“Setting the Default Style”](#) on page 203.

---

## Copying an Existing Style

Any existing style can be copied within the Style Editor. This is useful when you want to change only a few style properties while maintaining the majority of a style’s existing properties. Simply click on the style name and choose **Edit** → **Copy** or **Edit** → **Duplicate**. Alternately, you can right-click on the style and choose **Duplicate** (or **Copy** and then **Paste**). A style named "Copy of *style name*" is then added in the My Styles folder of the Style Editor.

---

### Note

Styles may be named and renamed as you wish.

---

# Applying Styles

Styles can be applied to a single item or all items within a view. When a new visualization is added to an existing tool, the style of any previous visualization will not be automatically applied unless the preferred style is set as the default style (as described in “[Setting the Default Style](#)” on page 203) or unless the `STYLE_NAME` keyword is used. `STYLE_NAME` allows you to specify the name of a user-defined or system style to be applied to the created visualizations.

Changes to style properties are not automatically reflected in your visualization. To update a visualization with a modified style, you must reapply the style.

When the **Update current tool style** checkbox is selected on the **Apply Style** dialog, the Current Style is updated. Any properties set in the style you have just applied are also changed in the Current Style. Other properties are left unchanged. Any new visualizations added from that point on will have the updated style applied.

Applying a style modifies only applicable items. If the style does not contain any properties that are relevant to the selected item or visualization, no changes are made to the visualization.

---

**Note**

Selecting **Edit** → **Undo/Redo** will completely undo the application of a style. If a style is applied and **Undo** is selected, all properties changed by the style revert to their pre-application values.

---

## Applying a Style to a Selected Item

You can apply a style to selected items in a visualization. For example:

1. From the IDL Command Line, visualize the following simple line graph:  

```
iPlot, RANDOMU(seed, 30)
```
2. Highlight and select the plot line by clicking on the line.
3. Select **Edit** → **Style** → **Apply Style...**

The **Apply Style** dialog appears (as shown in the following figure). Here you can select your preferred style to be applied to the plot item.

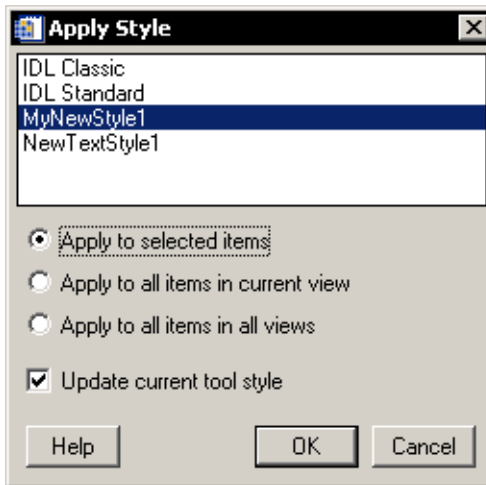

Figure 9-5: The Apply Style Dialog

4. After selecting your preferred style (here **MyNewStyle1** has been selected), choose **Apply to selected items** so that the style changes will only be made to the selected item. **MyNewStyle1** was created to contain properties to change line color, plot symbol type, and axis color. Because **Apply to selected items** is selected and not **Apply to all items in view**, you can expect that the axes will remain their original color (black).

---

**Note**

If a particular existing style does not contain style information for an item that you have selected (for instance, if a style does not contain text information and you have selected a text item), no changes will be made to that item when the style is applied.

---

5. Click **OK** and your style changes will be visualized (as shown in the following figure).

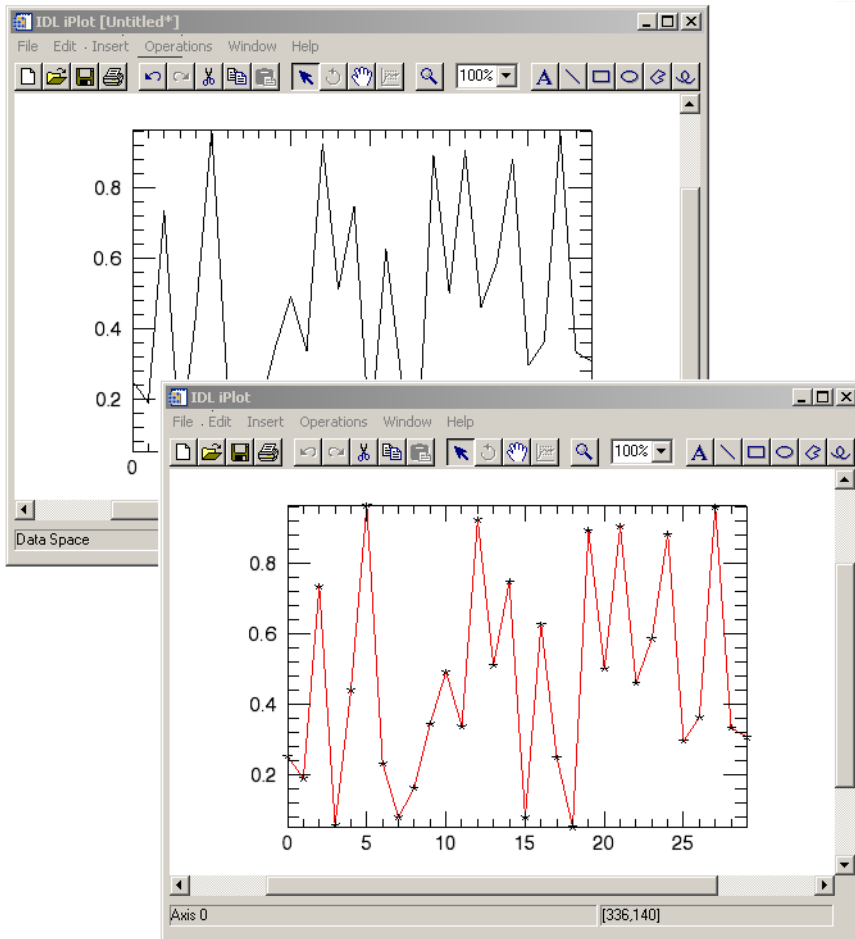

*Figure 9-6: iPlot Window Before (background) and After (foreground) Style Selection Application Changes Line Color and Plot Symbol Only*

**Note**

If nothing is currently selected, then style will be applied to the Visualization Layer within the current view.

## Applying a Style to All Items

You can also apply a style to all items within a view. For example:

1. Visualize a surface from the IDL Command Line by typing:  

```
iSurface, dist(20)
```
2. Next add a text annotation to your image reading: **New Surface**.
3. Now select **Edit** → **Style** → **Apply Style...**
4. The **Apply Style** dialog appears (as shown in the following figure), here you can select your preferred style to be applied to the text item.

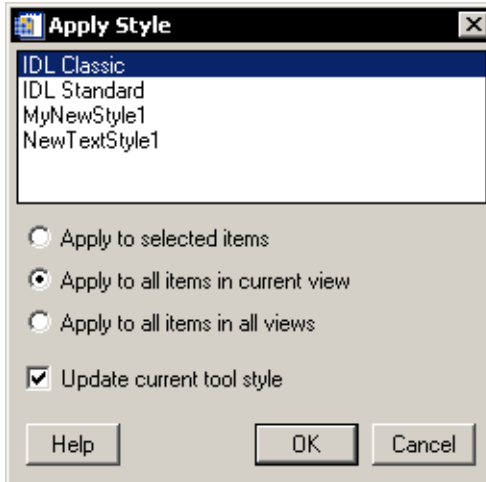

Figure 9-7: The Apply Style Dialog

5. After selecting your preferred style (here **IDL Classic** has been selected), select **Apply to all items in current view** so that the style changes will be made to all the items in the view.

### Note

Selecting **Apply to all items in all views** applies the style changes to every item in every view available in the current iTool (e.g., an iPlot tool)

subdivided into four views using the `VIEW_GRID` keyword from the command line).

6. Click **OK** and the style is applied to the entire visualization.

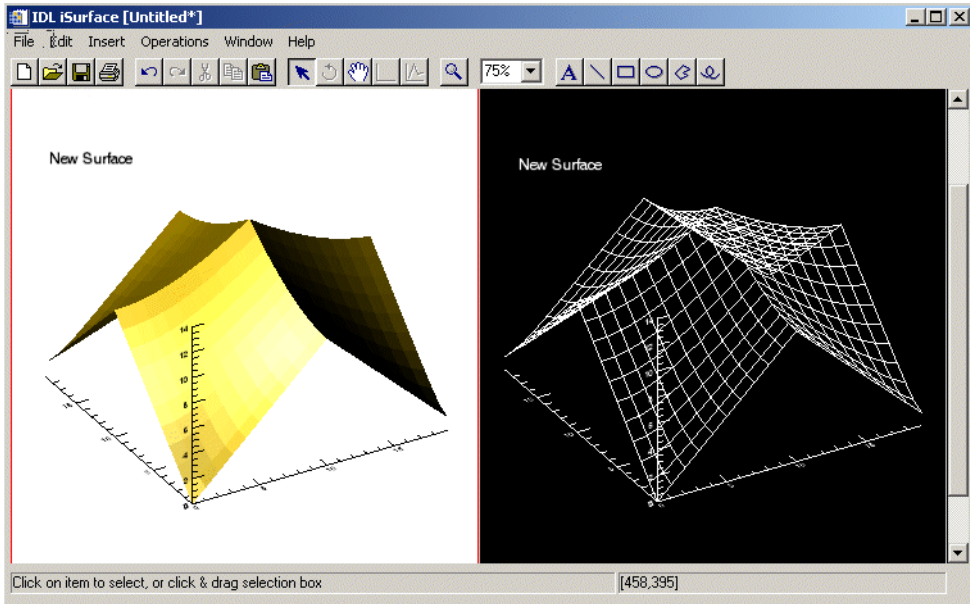

Figure 9-8: *iSurface* Window Before (left) and After (right) Entire Style Application

#### Note

Applying a style to all items will ignore items that have the **Show** property is set to `False` (i.e. hidden items).

## Applying a Style When Launching an iTool

The `STYLE_NAME` keyword allows you to apply a style to a visualization when an iTool is launched from the command line. This keyword can be used with any of the iTool routines (`ICONTOUR`, `IIMAGE`, `IMAP`, `IPLLOT`, `ISURFACE`, and `IVOLUME`).

Several system styles are included in your IDL distribution. For more information on setting a system style or created style, see [“Setting the Default Style”](#) on page 203.

**Note**

---

Styles specified in the STYLE\_NAME string override the default style.

---

# Editing Styles

The iTools Style Editor makes it possible to edit your existing personal styles as well as copies of IDL System Styles. The Style Editor is shown in the following figure.

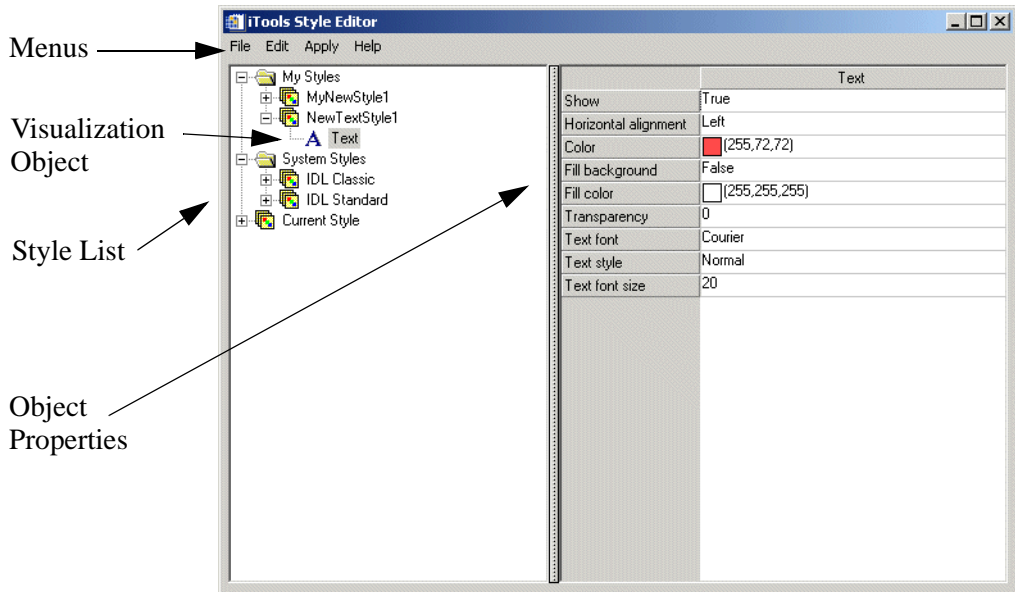

Figure 9-9: The iTools Style Editor

It is important to note that IDL's System Styles cannot be edited. These can, however, be copied as a new style and then edited. For information on copying styles, see “[Copying an Existing Style](#)” on page 193. The following section describes various editing tasks related to styles.

## Copying Properties Within Styles

You can copy properties from the Current Style, My Styles, and System Styles within the iTools Style Editor and paste these into any new or existing personal style. For example:

1. Select a style by clicking on it.
2. Select the style visualization object whose properties you wish to copy. The properties appear in the right panel of the editor.



3. Select a property by clicking on the property name and selecting **Edit** → **Copy** or right-clicking and selecting **Copy**.
4. Select the style name of the style in which you wish to add the copied property. The properties will be copied to corresponding visualization object within that style.
5. Select **Edit** → **Paste** or right click to select **Paste**. Your selected property is added to your selected style.

## Cutting and Deleting Properties within Styles

You can cut or delete properties from your personal styles but not from the Current Style or from the System Styles. For example:

1. From the iTools Style Editor, select a personal style and select a visualization object property you wish to delete.
2. Select **Edit** → **Cut** or **Edit** → **Delete**. Alternately, you can right-click on the property and select **Cut** or **Delete**.

### Note

---

Deleting a property from a personal style cannot be undone. Cutting a property places the property on the clipboard and the property may then be pasted within another style.

---

## Selecting Multiple Properties for Editing

Multiple properties may be copied and pasted (for all styles), and cut or deleted (only for personal styles) as shown for individual properties in the previous sections. To select multiple properties for these operations:

1. Select a style by clicking on it.
2. Select the style visualization object whose properties you wish to copy. The properties appear in the right panel of the editor.
3. Click on the property name and then, for the selection of multiple discontinuous items, hold down the **Ctrl** key while clicking on any other properties you wish to select. For continuous selection, hold down the **Shift** key while clicking on the final property you wish to select in your group. All selected property names should appear depressed.

4. With your cursor over one of the property names and all desired properties selected, right-click and select **Copy**. Alternately, with all properties selected, you can select **Edit** → **Copy**.

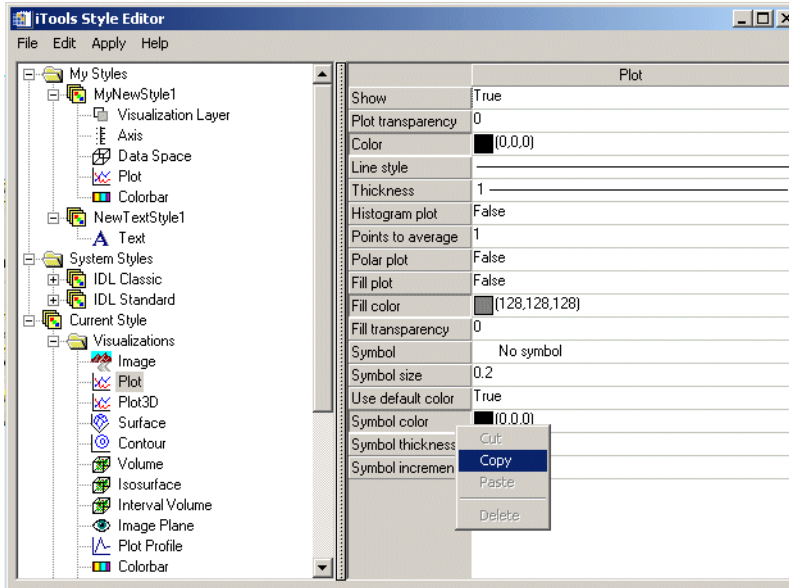

Figure 9-10: The iTools Style Editor with Multiple Properties Selected to Copy

5. You can now select the style name of the style in which you wish to add the copied properties and find and highlight the corresponding visualization object within that style.
6. Select **Edit** → **Paste** or right click to select **Paste**. Your selected properties are added to your selected style.

# Setting the Default Style

The default iTools style for your system can be set via the Preferences Browser. The Preferences Browser contains default property values used by all iTools. You can assign a personal style or any of the System Styles as the default iTools style preference. The default setting is none. To set a default style:

1. Select **File** → **Preferences**.
2. Select **General Settings**.
3. Select the desired style from the **Default Style** field drop-down list.

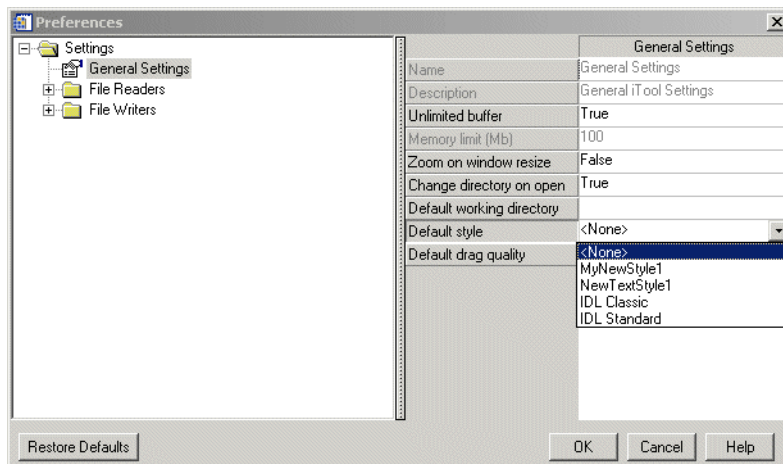

*Figure 9-11: Selecting the Default Style*

Once a default style is set, when a new iTool is started, the Current Style will contain a set of default values. That is, the default style is read into the Current Style.

---

**Note**

Because a default style is applied over the IDL system default settings, a default style does not need to include properties for all visualization types.

---

# Importing and Exporting Styles

You can use the Styles import/export functionality to share style files between yourself and other users.

## Exporting a File to Share

You can save (export) a style file to a place on your system to then share with other users. To do this:

1. From the Style Editor, select **File** → **Export...** and name the file, then save it into a directory as a style file (.sav).
2. This file can then be saved to a disk or sent via E-mail, FTP, etc. to another user.

## Importing a Received File

You can import a saved style file. To do this:

1. From the Style Editor, select **File** → **Import...** and locate the desired file.
2. Click **Open**.
3. The style should now appear in your style listing in the iTools Style Editor.



# Chapter 10

# Working with Images

This chapter describes how to use the Image iTool.

---

|                             |     |   |     |
|-----------------------------|-----|---|-----|
| Introduction .....          | 206 | Filtering an Image .....                | 218 |
| Displaying Images .....     | 207 | Applying a Morphological Operator ..... | 220 |
| Using the Image Panel ..... | 211 | Contouring an Image .....               | 221 |
| Image Properties .....      | 214 | Surfacing an Image .....                | 223 |
| Adding a Colorbar .....     | 215 | Manipulating the Image Display .....    | 224 |
| Adding Axes .....           | 216 | iImage Tool Operations .....            | 229 |
| Resampling an Image .....   | 217 |   |     |

# Introduction

The IDL `iImage` tool displays your data in image form. The `iImage` tool then allows you great flexibility in manipulating and visualizing image data. To use `iImage`, from the IDL Command Line, type `iImage`. An empty `iImage` tool appears. You can then import image data using any of several data import methods. For more information importing image data see [Chapter 2, “Importing and Exporting Data”](#).

---

**Note**

For more information on accepted arguments and keywords, see “[IIMAGE](#)” in the *IDL Reference Guide* manual.

---

The `iImage` tool can be launched in many different ways:

- At the IDL Command Line without arguments or keywords
- At the IDL Command Line with arguments or keywords
- Through the **File** → **New** → **Visualization** → **iImage** menu option in the IDL Development Environment
- Through the **File** → **New** → **iImage** menu option in an `iTool`

Common image file formats accepted are listed in “[Importing Image Data](#)” on page 34.

# Displaying Images

The iImage tool's primary design is to visualize image data, though the tool is capable of much more once the data is displayed. The iImage tool also allows you to manipulate and edit the displays. The first task is to display the image data.

Your options for invoking the iImage tool are:

- At the IDL Command Line without arguments or keywords
- At the IDL Command Line with arguments or keywords

For more information on accepted arguments and keywords, see “**IIMAGE**” in the *IDL Reference Guide* manual.

- Through the **File** → **New** → **Visualization** → **iImage** menu option in the IDL Development Environment
- Through the **File** → **New** → **iImage** menu option in an iTool

To visualize image data in the iImage tool:

1. Image data can be loaded into the data manager. Image data of any supported type can also be directly visualized into the iImage tool using **File** → **Open** or the File Open icon  at the top left of your iImage window, and the File Open Dialog appears.
2. Select the desired image file from your directory structure. For example here we will visualize an `examples/data` file named `afrpolitsm.png`. Select the file name and click **Open**.

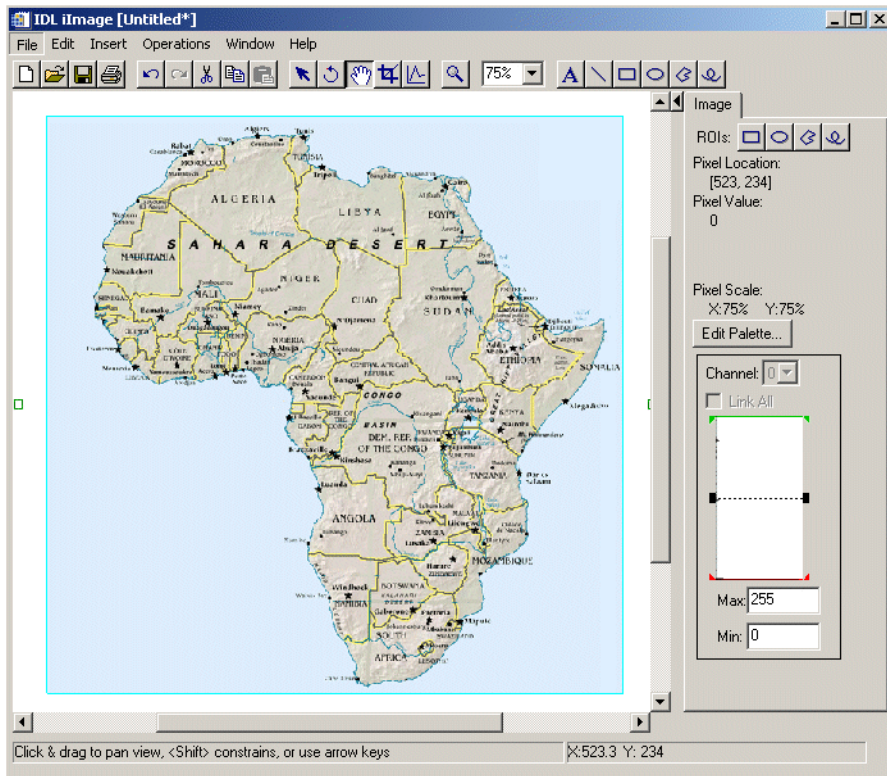

Figure 10-1: A JPEG File Visualized Using the *iImage* Tool

### Note

The examples/data subdirectory of your IDL distribution contains a text file named `index.txt`. This file lists all data files available in the example directory and also lists their dimensions and values.

## Displaying Multiple Images

You can use the window layout dialog to provide for multiple image display within your window. To add another image to the window containing the image you just visualized:

1. From the *iImage* window displaying the political map of Africa JPEG image, select **Window** → **Layout**.



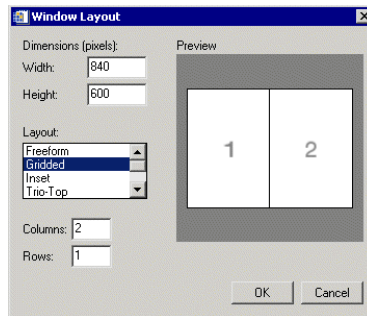



Figure 10-2: The Window Layout Dialog

The Window Layout dialog contains these items:

- **Dimensions** — Allows you to enter specific window dimensions.
- **Layout** — Allows you to pick from a scroll-down list of layout options and grids.
- **Preview** — Gives you a visual preview of the selected layout.

For more information on working with window layouts, see [“Window Layouts”](#) on page 73.

2. Select a layout, in this case select **Gridded** and then enter 2 and 1 for **Columns** and **Rows** and then **OK**.

3. The window now displays a two by two arrangement of views. You will notice the original political map of Africa image is shifted to the top-left view. Select and highlight the top-right view.
4. Select **File** → **Open** or the File Open icon  at the top left of your iImage window, and from the **File Open** Dialog select the `examples/data` image named `africavlc.png` and click **Open**.
5. The second image of the African continent now appears in the top-right view.

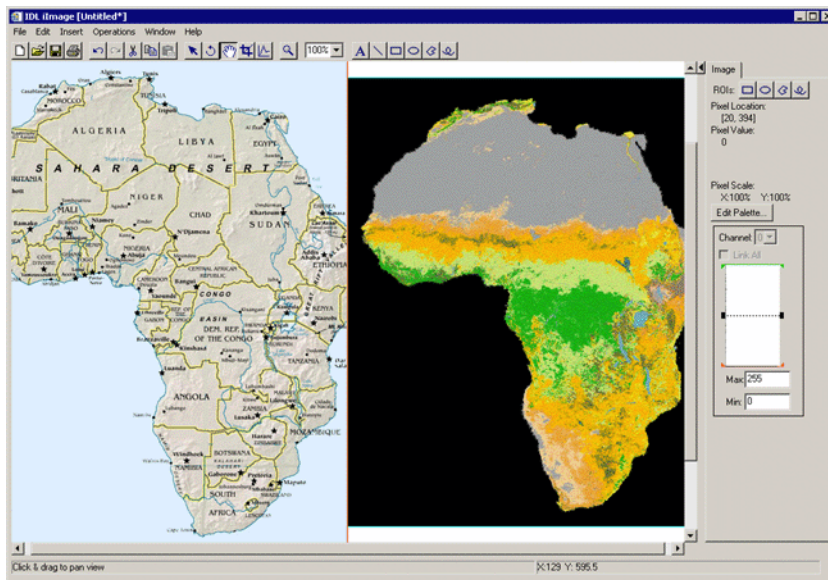

Figure 10-3: Displaying Multiple Images in iImage

## Using the Image Panel

The image panel appears to the right of the visualization window of the iImage tool. This panel allows you to view and manipulate various image properties such as pixel location and values and color properties. You can also draw ROIs within your visualization. The components and functions of the image panel are discussed in the following figure and list.

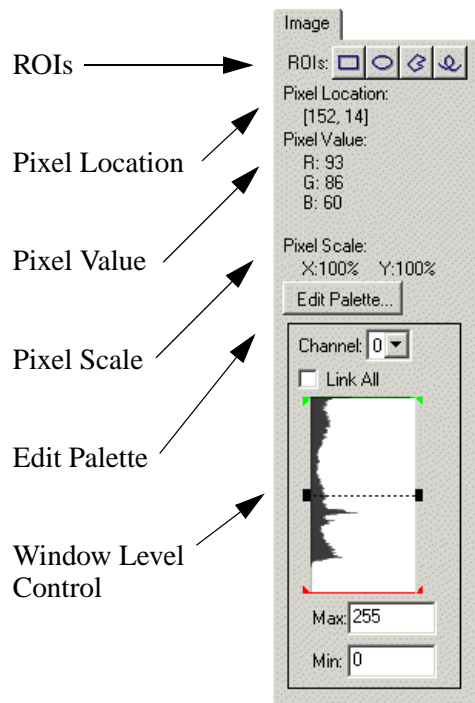

Figure 10-4: The Image Panel

- **ROIs** — The ROI buttons on the image panel allow you to draw regions of interest within your visualization. For more information on ROIs, see [Image ROIs](#) in the following section.
- **Pixel Location** — If your pointer/cursor is held over the visualization, the precise pixel location will be shown in this area.
- **Pixel Value** — Pixel color values are shown in this area.

**Note**

---

If the byte scaled pixel value (used for display) is different from the image data value at that pixel, it will be displayed in parentheses.

---

- **Pixel Scale** — Pixel scale data is shown in this area.
- **Edit Palette** — This button is enabled for indexed binary and greyscale color images. For more information on the Palette Editor, see [The Palette Editor](#) in the following section.
- **Window Level Control** — The window level control allows you to adjust and manipulate the image brightness and contrast by changing the RGBA or indexed channel values. For more information on the window level control, see [Window Level Control](#) in the following section.

## Image ROIs

The ROI buttons (shown in the Image Panel in the preceding figure) allow you to draw regions of interest within your visualization. You can select from rectangular, elliptical, polygonal, and freehand region of interest buttons. Once you have created your ROI, you can also apply operations to image data contained within an ROI area.

**Note**

---

The ROI tools are not available for images that have an associated map projection.

---

Select the desired button and then hold your cursor over the area in the visualization where you wish your ROI to appear. Click the left mouse button and drag until the ROI is the desired shape and location. ROIs can be selected and moved or deleted after they are drawn.

**Note**

---

For more information on operations and regions of interest, see [“Operations on Regions of Interest”](#) on page 131.

---

## The Palette Editor

RGB images contain their own color information while color information for indexed images is separate from the image itself. Color information can be modified for indexed and greyscale images.

The easiest way to modify color attributes for a selected indexed, binary, or greyscale image is to click on the **Edit Palette...** button on the image panel to the right of your visualization.

The various components and functions of the Palette Editor are discussed in “[CW\\_PALETTE\\_EDITOR](#)” in the *IDL Reference Guide* manual.

---

**Note**

You can also access the palette editor by selecting the image visualization (clicking once on the visualization and then double-clicking on it to bring up the Visualization Browser) and selecting **Image Palette** → **Edit Color Table** → **Edit**.

---

## Window Level Control

The Window Level Control on the iImage tool allows you to adjust and manipulate the image brightness and contrast for each channel of the currently selected image. The **Channel** droplist allows you to select the channel to be adjusted. The **Link All** checkbox may be selected to cause all channels to be adjusted simultaneously. A small plot window shows the histogram for the currently selected channel. For indexed color images, Channel 0 represents the image data values. For RGBA images, Channel 0 represents the red values, Channel 1 represents the green values, Channel 2 the blue values, and Channel 3 the alpha values (if present). Within the plot area is a red bar representing minimum values and a green bar representing maximum values. You can click on each bar to manipulate these values. The dotted black bar represents the level; you can click and drag this bar to move both the minimum and maximum values simultaneously.

# Image Properties

The iImage tool is a self-contained image display and manipulation tool. You can import, export, modify, and manipulate image data. For more information on the basic iImage interface and its layout, see [Appendix A, “iTools Interface Reference”](#).

## Modifying Properties

By selecting **Edit** → **Properties** from the iImage tool, you may modify your image properties. You may modify your image’s name, description, transparency, interpolation, pixel dimensions, pixel origin, and so on. For more information on editing properties in the iTools, see [Appendix D, “Visualization Properties”](#).

# Adding a Colorbar

You can add a colorbar to your visualized image which will show on a color scale the minimum to maximum pixel values. To add a colorbar, click on the image and then from the iImage window, select **Insert** → **Colorbar**. A colorbar will be placed in the visualization window. This colorbar can be resized and moved around the window. You can also double-click on the colorbar to invoke the Visualization Browser, which will allow you to change properties for the colorbar.

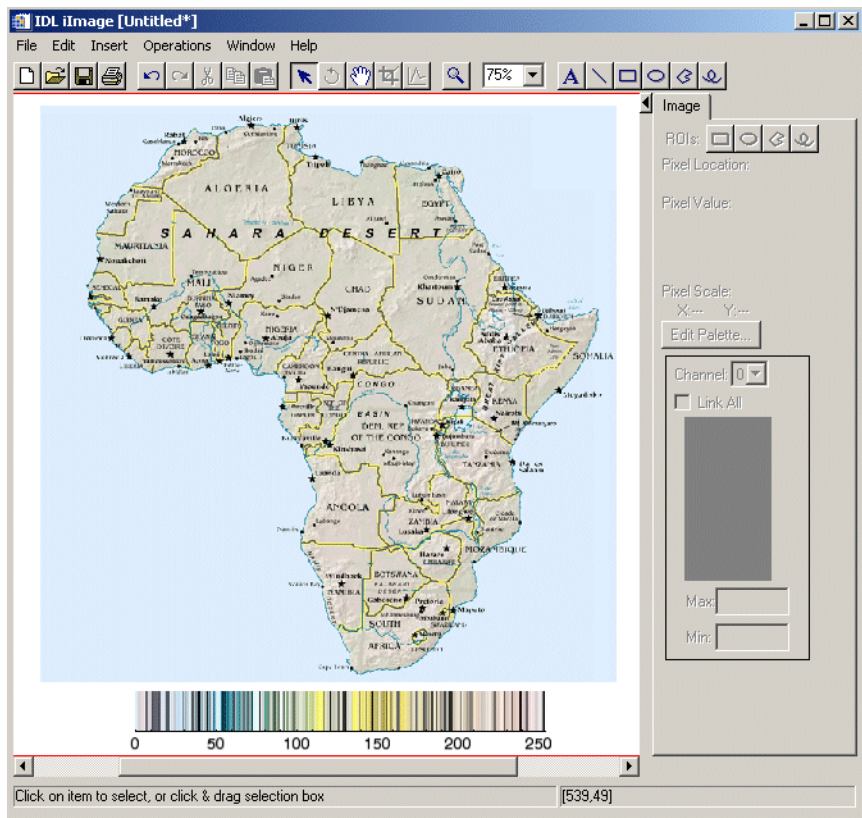

Figure 10-5: Image With Inserted Colorbar

# Adding Axes

You can add X and Y axes to your image data by selecting **Insert** → **Axis** from the iTool window. From here you can select **X Axis** or **Y Axis**. You can modify axis properties by opening the Visualization Browser and selecting **Axes** and then changing the **Style** property from **None** to the desired style. Another option is to double-clicking on the axis itself within the visualization and modify its properties.

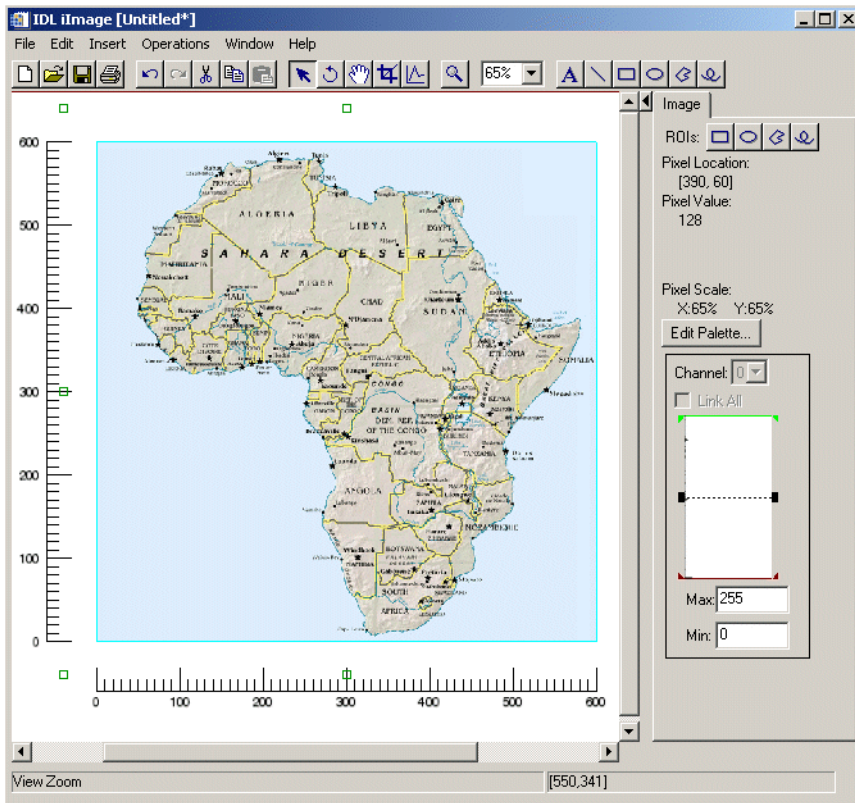

Figure 10-6: Image in *ilimage* with Axes Inserted and Placed



# Resampling an Image

Resampling re-imports the selected image data using parameters specified in the Resample properties. Resampling parameters include factors for adjusting the X, Y, or Z dimensions of the data, as well as the interpolation method to be used.

To resample image data:

1. Select one or more images in the iImage window for resampling.
2. If necessary, use the Operations Browser to set the desired parameters through the Resample properties. See [“Resample Properties”](#) on page 388 for details.
3. Select **Operation** → **Transform** → **Resample**.

# Filtering an Image

There are six types of filters available in the iImage tool.

## Convolving an Image

To convolve an image:

1. Select the image to be convolved.
2. Select **Operations** → **Filter** → **Convolution**.
3. The convolution filter editor appears and desired settings can be edited.
4. Click **OK** and the filter is applied.

For more details on the convolution filter, see “[Convolution Filter](#)” on page 122.

## Applying a Median Filter

The median filter replaces each pixel with the *median* (a value in an ordered set of values with an equal number of values above and below it) of the two-dimensional neighborhood of a given width.

To apply the median filter to an image:

1. Select the image.
2. Select **Operations** → **Filter** → **Median**.

For more details on the median filter, see “[Median Filter](#)” on page 121.

## Smoothing an Image

The smooth filter removes unwanted noise from an image using a weighted average.

To apply the smooth filter to an image:

1. Select the image.
2. Select **Operations** → **Filter** → **Smooth**.

For more details on the smooth filter, see “[Smooth Filter](#)” on page 120.

## Applying a Roberts Filter

The Roberts filter uses the Roberts edge enhancement operator to detect edges within the image.

To apply the Roberts filter to an image:

1. Select the image.
2. Select **Operations** → **Filter** → **Roberts**.
3. The Roberts filter is applied.

## Applying a Sobel Filter

The Sobel filter uses the Sobel edge enhancement operator to detect edges within the image.

To apply the Sobel filter to an image:

1. Select the image.
2. Select **Operations** → **Filter** → **Sobel**.
3. The Sobel filter is applied.

## Applying an Unsharp Mask

The unsharp mask enhances the contrast between neighboring pixels in an image.

To apply the Unsharp Mask filter:

1. Select the data that you want to unsharp mask.
2. Select **Operations** → **Filter** → **Unsharp Mask**.

For more details on the unsharp mask filter, see [“Unsharp Mask Filter”](#) on page 123.

# Applying a Morphological Operator

Mathematical morphology is a method of processing digital images on the basis of shape. Six morphing options are available for use in iImage: dilate, erode, morph open, morph close, morph gradient, and morph tophat. For more information on morphing, see “[Morphing](#)” on page 125. To morph your image, select **Operations** → **Morph** → *<option>*.

# Contouring an Image

You can also insert a contoured representation of your image data into your visualization. To do this:

1. From the iImage window containing a visualized image, select **Operations** → **Contour**.
2. The Contour dialog appears (shown below) allowing you to adjust contour setting, including:
  - **Number of levels:** Set the number of contouring levels
  - **Value:** Set the contour value to use
  - **Projection:** Choose the contour type (Planar or 3D)

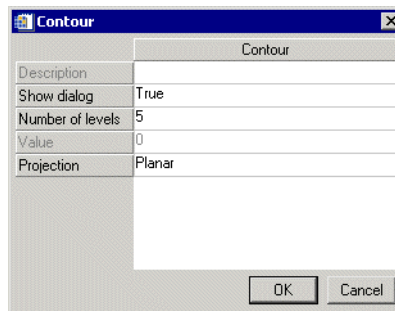

*Figure 10-7: The Contour Dialog*

3. After making any contour property changes, select **OK** to contour your image data.

The following figure shows contouring added to the image of a meteor surface.

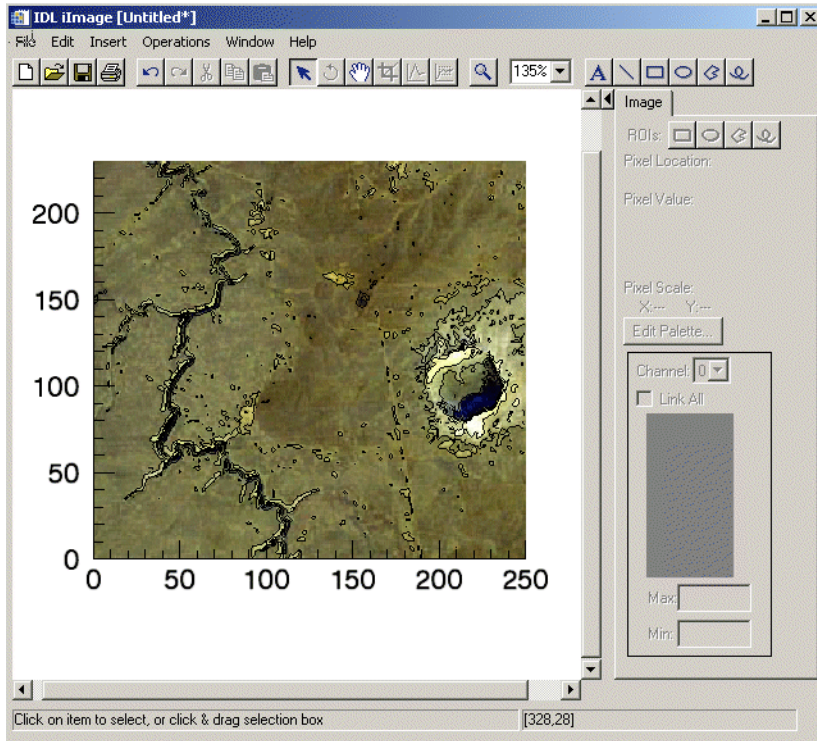
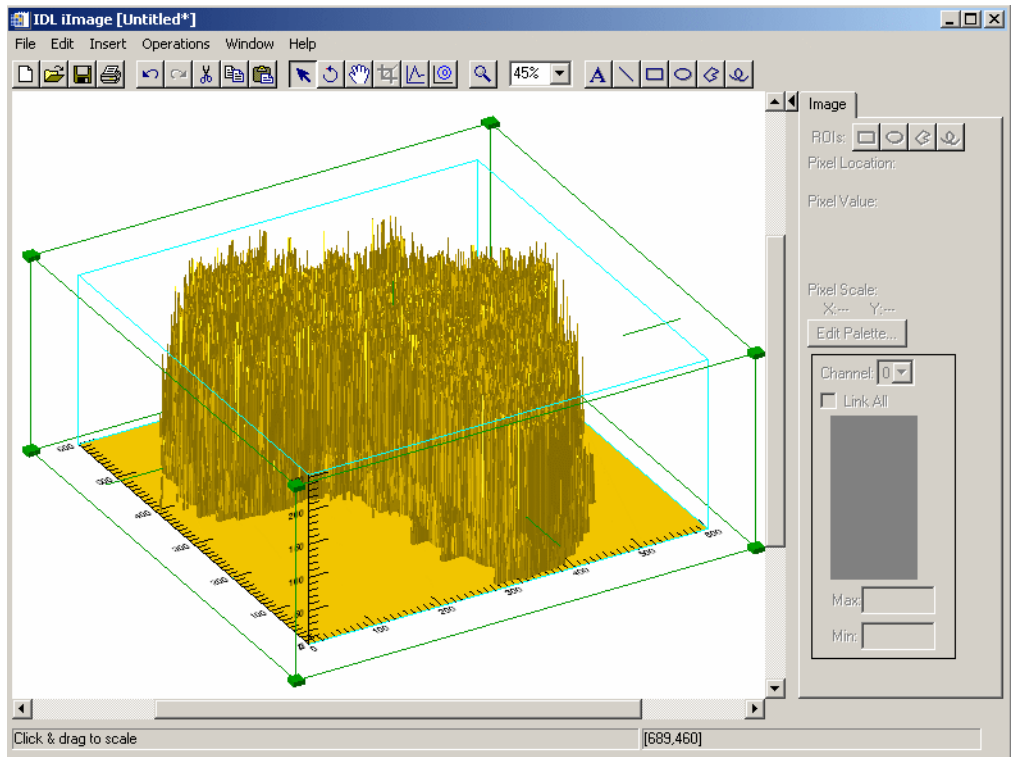

*Figure 10-8: A Contoured Image in iImage*

You can highlight and double-click your contoured image data, invoking the Visualization Browser which allows you to edit Contour Level properties and Contour Level color table data. For more information on these edit options, see “[Contour](#)” on page 432.

# Surfacing an Image

You can also insert a surface representation of your image data into your visualization by selecting **Operations** → **Surface**. This causes the display to become three-dimensional. The following figure shows a surface added to the image of the African political map.



*Figure 10-9: Image Data Shown as a Surface*

You can highlight and double-click your new surface, invoking the Visualization Browser which allows you to edit surface properties. For more information on these edit options, see “[Surface](#)” on page 428.

# Manipulating the Image Display

The iImage tool allows you many options to manipulate your existing image displays. Once you have visualized your image, you may rotate, flip, translate, scale, and zoom as well as modify image properties, scroll, and select image ROIs. The following options are available for manipulating images.

For more information on manipulation tasks which are common to iImage as well as other iTools, see [Chapter 4, “Manipulating the Display”](#).

## Rotating an Image

The rotate operation makes it possible to rotate the image within the visualization by a specified number of degrees. To rotate your selected image, select **Operations** → **Transform** → **Rotate Data**. For more information about rotating, see [“Rotation”](#) on page 113.

## Scaling an Image and Byte Scaling an Image

It is possible to scale the pixel values within an image by a specified scale factor. To scale your image, select **Operations** → **Transform** → **Scale Data**. For more information on scaling data, see [“Scaling”](#) on page 65.

### Note

---

When working with byte data, the default byte scale range is always 0-255. Therefore, even if data ranges from 0-100, it will display using 0-255. This may cause visualized data to appear darker.

---

## Inverting an Image

You can also invert the data associated with your image, or with each channel of an RGB or RGBA image. If the data is byte data, the inversion occurs relative to the maximum byte value (255). Otherwise, the inversion occurs relative to the maximum data value per channel. To invert your image, select **Operations** → **Transform** → **Invert Image**.

## Flipping an Image

You can flip your image within the data space either horizontally or vertically. These operations flip the actual data associated with the image. To flip your data, select **Operations** → **Flip** → **Flip Horizontal** or **Operations** → **Flip** → **Flip Vertical**.



## View Zoom

View Zoom allows you to zoom in or out on a specific area of the image display area. To zoom in or out in View Zoom mode click Zoom  on the toolbar or select a percentage value from the View Zoom droplist. For more information on working with View Zoom, see “[Zooming](#)” on page 70.

## Canvas Zoom

Canvas Zoom allows you to increase or decrease the magnification of the entire display canvas (which may contain multiple views, depending on the layout) by a specified percentage. Canvas Zoom is available by selecting a percentage from the **Window** → **Canvas Zoom** menu. For more information on working with Canvas Zoom, see “[Zooming](#)” on page 70.

## Pixel Scaling

The pixel scale represents the number of window pixels used to display a single image pixel (horizontally and vertically). Pixel scaling is shown on the image panel (which appears on the right side of the iImage tool) and can be manipulated via the View Zoom manipulator on the iImage window toolbar and using its accompanying pull-down menu.

When an image is first loaded into iImage, the X and Y pixel scales are by default set to 100% (one window pixel is used to display one image pixel horizontally). Typically, when iImage first displays an image, the view zoom factor matches the X pixel scale. Changing the view zoom factor also updates the pixel scale labels.

If the currently selected image has been rotated, or if the visualization has switched to 3D (for example, because a surface was inserted), then the pixel scale labels are set to an empty string.

## Region Growing

The iImage region growing operation lets you apply a region growing algorithm to the currently selected ROI. A new ROI is then created and displayed. To apply region growing to your ROI, select **Operations** → **Region Grow**. You can then select the region grow method (by threshold or by standard deviation).

## Adding Annotations

Annotations can be added to label or describe image visualizations displayed in the iImage tool.

The following types of annotations can be added to iImage displays:

| Image Annotation Type | Description  |
|-----------------------|--|
| Text                  | Single lines or multiple lines of text can be added to a visualization to provide a label or description     |
| Line                  | Straight line annotations can be added to a visualization to link labels to objects or to identify an object |
| Rectangle             | Rectangular annotations can be added to a visualization to identify rectangular areas                        |
| Oval                  | Oval annotations can be added to a visualization to identify circular areas                                  |
| Polygon               | Polygon annotations can be added to a visualization to identify areas bounded by a multi-sided polygon       |
| Freehand              | Freehand annotations can be added to a visualization to identify an area                                     |

*Table 10-1: Types of Image Annotations*

For more information on creating and using annotations, see [Chapter 5, “Adding Annotations”](#).

## Line Profiles

You can plot image pixel values along a selected line. These values are extracted as a line profile of part of your image visualization and displayed in a new iPlot window:

1. From an iImage window with a visualized image, click on the **Line Profile** icon on the toolbar.
2. Use the mouse to position the jagged-edge line profile tool over the place which you wish your line profile to begin and click.
3. Drag to the ending point of your line profile and release.

4. A new plot window appears showing a plot of the image pixel values that fall along that line.

Once a line profile has been drawn, it will remain until deleted. The line may be translated (or its endpoints moved individually). If it is translated or edited, the profile plot will automatically update.

**Note**

Line profiles on map projections always connect points using the image coordinates (either degrees or meters). See “[Registering an Image](#)” on page 333 for more information on image coordinates.

## View Panning

To pan an image, select the View Pan tool button  on the toolbar and then click on the image and drag until it is in the desired location. Panning causes the extents of the visible portion of the view to be shifted.

## Cropping an Image

The iImage crop manipulator button allows you to crop your image to your specified size and dimension. It also allows you to translate and resize the crop box, and then apply the crop to the currently selected image or images. The button appears in the toolbar as shown in the following figure.



*Figure 10-10: The Crop Manipulator Button on the Toolbar*

The crop box will appear only if information has been set and is applicable to the currently-selected image. If the crop box information has not been set for the crop operation, or does not fit within your image, then no crop box appears. For more information see “[Cropping Images](#)” on page 229

If no crop box visual is present, you can click using the mouse anywhere on an image and drag to create a crop box.

**Note**

---

All portions of the image that fall outside of the crop box are grayed out.

---

Once a crop box is present, it may be translated (by clicking and dragging anywhere within the crop box, or along its edges) or scaled (by clicking and dragging on one of the scale handles). A new crop box can also be created by clicking anywhere within the gray area outside of the current crop box.

The arrow keys can also be used to translate the crop box (when the mouse location is anywhere within the crop box or along its edges).

When your crop box is correctly sized and positioned, you can crop the image by:

- Double-clicking anywhere within the defined crop box
- Right clicking to invoke the context menu, and then selecting Crop
- Selecting **Operations** → **Crop** from the iImage tool.

# ilImage Tool Operations

The iImage tool provides the following operations:

## Viewing a Histogram

A histogram is a density plot showing a distribution of data values. To view a histogram of image data, use the iTool's histogram feature by selecting **Operations** → **Histogram**. For information on histogram creation, see [“Plotting a Histogram”](#) on page 126.

## Viewing Image Statistics

To view statistics for image data or for ROIs, use the iTool's statistics feature by selecting **Operations** → **Statistics**. For information on viewing statistics, see [“Displaying Statistics”](#) on page 127.

## Cropping Images

The iImage cropping operation allows you to crop one or more selected images at a specified location and specified dimensions. To activate the cropping operation, select **Operations** → **Crop**. The Crop manipulator is automatically activated.

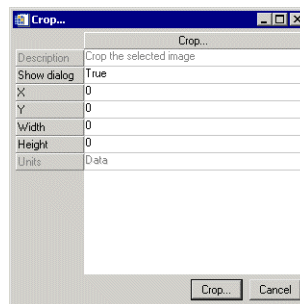

Figure 10-11: The Crop Operation Dialog

### Note

The appearance of this dialog can be disabled for future uses of the crop operation by setting the Show dialog property to False.

The X, Y and Width, Height properties in the dialog represent the location and dimensions of the crop box to be applied. If these values have never been set, they are by default initialized to match the full extent of your first selected image. If these values have previously been set, they are constrained to fit within the first selected image. You can enter new values manually, or the mouse can be used to define, resize, and/or translate the crop box.

The Units property can be set to indicate the units of measure to be used for reporting crop box coordinates. The default is data units. This property will automatically reset to data units (and become de-sensitized) if multiple images are selected and their pixel origins or pixel sizes differ.

Once your crop dialog is present on your image, you can crop by doing the following:

- Double-clicking anywhere within your defined crop box (in the primary visualization window).
- Pressing the Crop button within the crop operation dialog.

Once your image is cropped, the original image is replaced by the new, cropped image data. You can only retrieve your original data by selecting **Edit** → **Undo crop**, or by reloading the original image data as a separate visualization.

---

**Note**

If your original image contains any ROIs, those that do not lie completely within the crop box will be lost in the new image.

---



## Chapter 11

# Working with Surfaces

This chapter describes how to work with surfaces in the iSurface tool.

---

|                           |     |                                     |     |
|---------------------------|-----|-------------------------------------|-----|
| Introduction .....        | 232 | Contouring a Surface .....          | 242 |
| Displaying Surfaces ..... | 233 | Resampling a Surface .....          | 244 |
| Surface Properties .....  | 235 | Filtering a Surface .....           | 245 |
| Adding a Colorbar .....   | 237 | Adding a Texture Map .....          | 246 |
| Adding a Light .....      | 238 | Manipulating Surface Displays ..... | 247 |
| Adding a Legend .....     | 239 | iSurface Tool Operations .....      | 252 |
| Adding Axes .....         | 240 |                                     |     |

# Introduction

The IDL iSurface tool provides interactive access to surface data. You can visualize surfaces and then modify and manipulate those surfaces in the ways that you need. The following sections describe how surfaces can be displayed, modified, and manipulated in iSurface.

To use iSurface from the IDL Command Line, type `iSurface`. An empty iSurface tool appears. You can then import surface data using any of several data import methods. For more information on importing surface data, see [Chapter 2, “Importing and Exporting Data”](#).

---

**Note**

For more information on accepted arguments, see “`ISURFACE`” in the *IDL Reference Guide* manual.

---

The iSurface tool can be launched in the following ways:

- At the IDL Command Line without arguments or keywords
- At the IDL Command Line with arguments and keywords
- Through the **File** → **New** → **Visualization** → **iSurface** menu option in the IDL Development Environment
- Through the **File** → **New** → **iSurface** menu option in an existing iTool



# Displaying Surfaces

Three-dimensional visualizations of surfaces can be displayed in the iSurface window.

To open an iSurface window, do one of the following:

- At the IDL command line, enter `ISURFACE`
- From an iTool window, select **File** → **New** and select **iSurface**

Surface data can be displayed by specifying data parameters at the IDL command line, or by importing a binary or ASCII text file containing surface data.

To import a file containing surface data into the iSurface tool:

1. Select **File** → **Open** from the iSurface tool and locate the file to open. For example, from your IDL `examples/data` directory, select `idemosurf.dat`.
2. Double-click the filename or select the filename and click **Open** to open the surface data file. You will be prompted to enter information regarding your file type (for example, ASCII or binary). For more information on entering this information and on importing data, see [Chapter 2, “Importing and Exporting Data”](#). In this example, enter *demosurface* for your template name and then select **New Field** and specify *demosurface* as the **Field Name** and specify it as a two-dimensional 200 by 200 Floating type.
3. Then select **OK** and **OK** to dismiss and visualize.

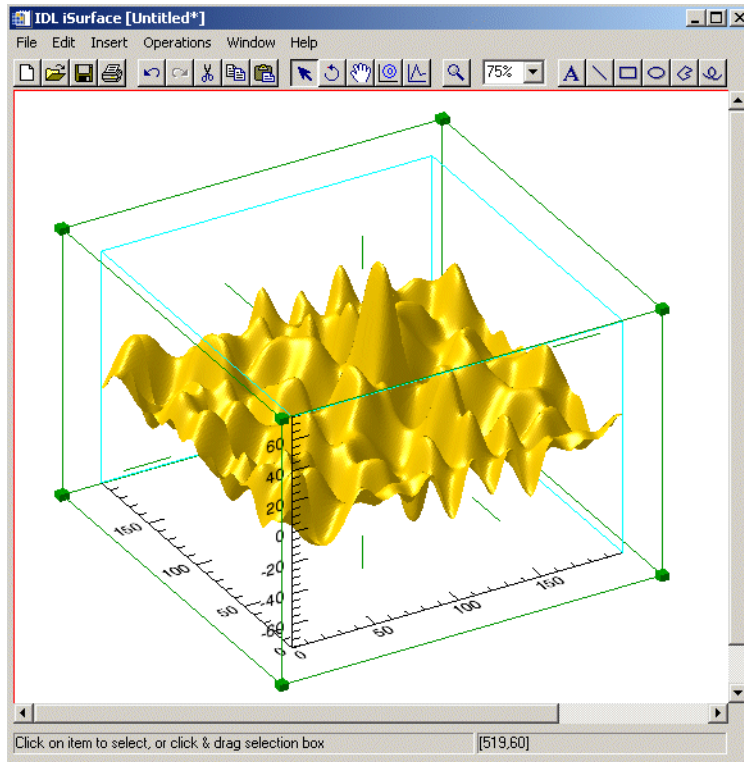

*Figure 11-1: Surface Data Visualized in iSurface*

# Surface Properties

Surfaces have attributes or *properties* that can be modified to change their characteristics. These properties are organized into *property sheets* for each operation and visualization type. For example, the skin of a surface visualization has a gold color by default. To change this color, modify the surface color property in the surface visualization property sheet.

To display the property sheet for a surface, do one of the following:

- Double-click the surface in the iTool window
- Select the surface, and select **Edit** → **Properties**
- Display the Visualization Browser, and double-click the entry for the surface

For more information, see [Chapter 6, “Property Sheets and Browsers”](#).

## The Visualization Browser

The Visualization Browser provides a nested list of all visualizations displayed in the iSurface window. From the Visualization Browser, you can select visualizations and display property sheets for those visualizations.

To display the Visualization Browser:

1. Select **Window** → **Visualization Browser**.
2. Do either of the following:
  - Click an item to select it in the Visualization Browser
  - Double-click an item in the iTool window to display its property sheet

For more information, see [Chapter 6, “Property Sheets and Browsers”](#) and [Appendix D, “Visualization Properties”](#).

## The Operations Browser

The Operations Browser provides a nested list of all operations available from the iSurface Operations menu. From the Operations Browser, you can display property sheets for each of the items in the iSurface Operations menu.

To display the Operations Browser:

1. Select **Operations** → **Operations Browser**
2. Click an item to display its property sheet

For more information, see [Chapter 6, “Property Sheets and Browsers”](#) and [Appendix C, “Operations Properties”](#).

## Adding a Colorbar

If you have added vertex coloring or texture to your surface visualization, you can add a colorbar that will show on a color scale the minimum to maximum values of data in the visualization. To add a colorbar, click on the surface data and then from the iSurface window, select **Insert** → **Colorbar**. A colorbar will be placed in the visualization window. This colorbar can be resized and moved around the data space. You can also double-click on the colorbar to invoke the Visualization Browser which will allow you to change the values for the colorbar. For more information on the colorbar, see “[Colorbar](#)” on page 450.

# Adding a Light

Adding a light to your surface display allows you to highlight various parts of the surface. To add a light to your surface display, select **Insert** → **Light**. you can click on the light bulb which appears and drag it around the display area to manipulate the lighting. You can also adjust the lighting settings using the Visualization Browser by double-clicking on the light bulb.

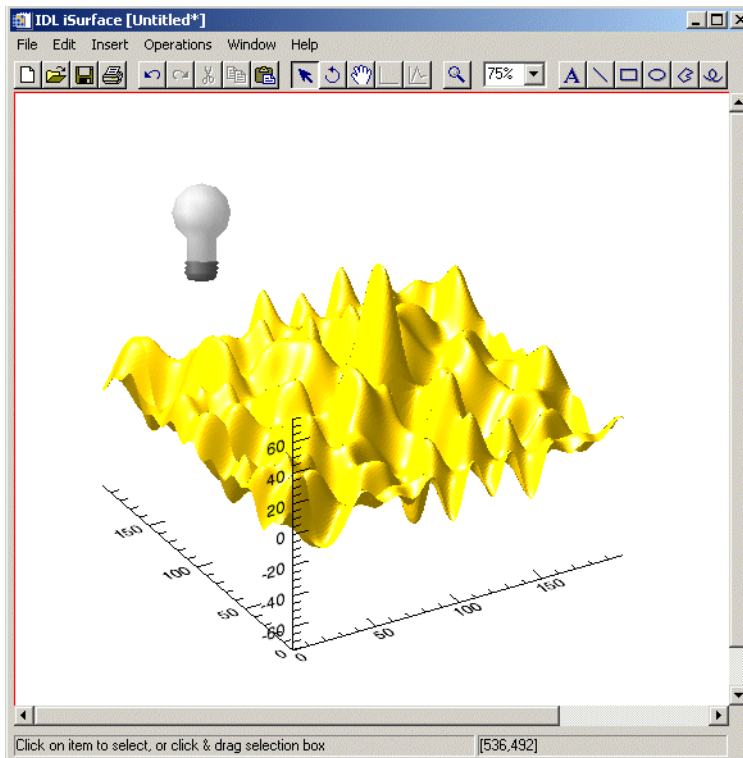

Figure 11-2: Inserting Light into a Surface Display

# Adding a Legend

Legends identify the visualizations displayed in the iTool window. Legends can be displayed in the iSurface window to identify surfaces and contours on those surfaces.

To insert a legend for a surface or contour:

1. Select specific items to include in the legend, or click in an empty area of the iSurface dataspace to deselect and include all dataspace items in the legend.
2. Select **Insert** → **New Legend**.

To add to a legend:

1. Select the visualization item or items to add to the legend.
2. If there are multiple legends, add the desired legend to the selection by shift-clicking the legend border.
3. Select **Insert** → **Legend Item**.

---

**Note**

Only a single legend item may exist for a given visualization. If you are inserting multiple visualization items into an existing legend, only legend items for those visualizations not already represented will be added to the legend.

---

For more information, see [“Legends”](#) on page 77.

# Adding Axes

By default, surfaces are displayed with X, Y and Z axes. The display of these axes is controlled by property sheets for the axes container and for individual axes (see [“Axes”](#) on page 458). Additional X, Y or Z axes can be added to a surface visualization to make it easier to identify surface characteristics.

To add an axis to your surface visualization:

1. Select the surface.
2. Select **Insert** → **Axis**.
3. Choose from the following options:
  - **X axis**
  - **Y axis**
  - **Z axis**

Use the mouse to position the new axis, and double-click the axis to display the axis property sheet.

For more information on adding axes, see [“Additional Axes”](#) on page 84.



# Imaging a Surface

You can insert an image of your surface data by using **Operations** → **Image**. An image visualization of your original surface data is then displayed with your original surface visualization.

For example at the IDL command line,

1. Enter `iSurface, DIST (10)`
2. Now select **Operations** → **Image**.

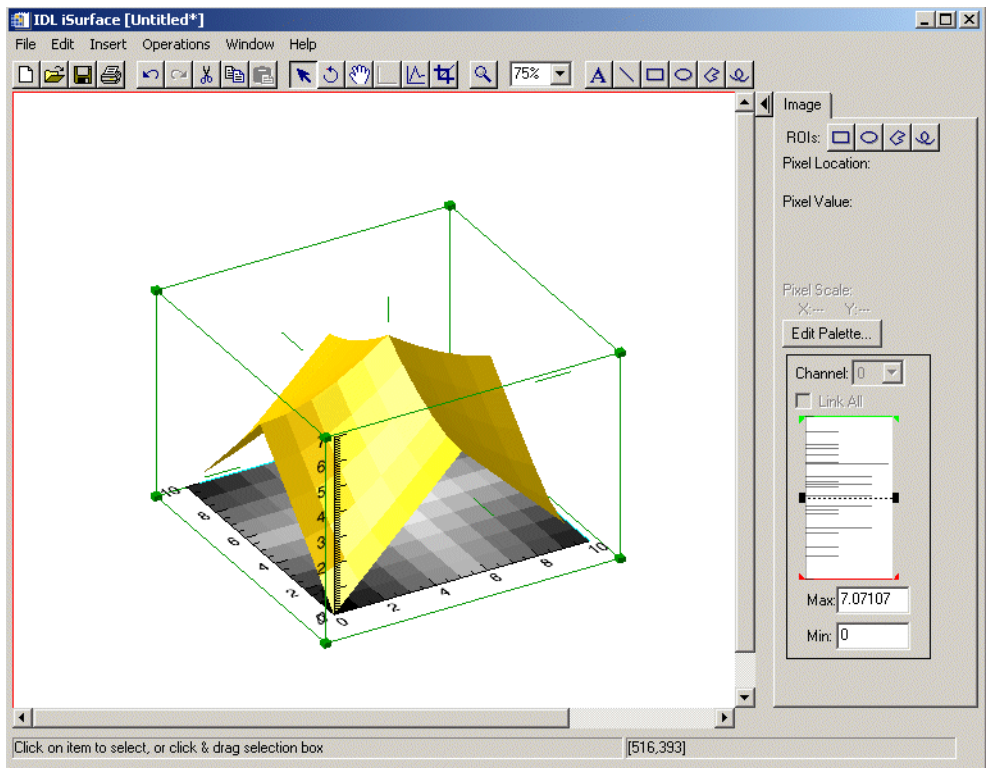

Figure 11-3: Surface Visualization with Image Added

# Contouring a Surface

Contour lines can be drawn directly on a surface to provide information about the levels of the surface, such as elevation. Two types of contours can be applied: multiple-level contour operations that apply to the surface in general, and single-level contour objects applied at a specific location on the surface.

To add contour lines to a surface:

1. Select the surface in the iTools window. For example, select the `isurfdemo.dat` surface data previously visualized.
2. Select **Operations** → **Contour**.
3. The Contour dialog appears (shown below) allowing you to adjust contour setting, including:
  - **N\_LEVELS**: Set the number of contouring levels
  - **Value**: Set the contour value to use
  - **Projection**: Choose the contour type (Planar or 3D)

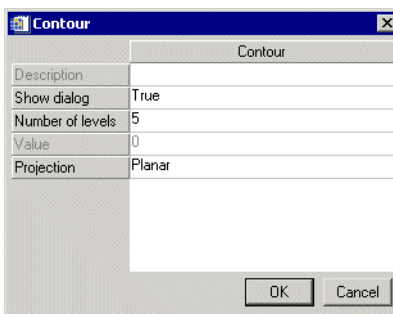

Figure 11-4: The Contour Dialog

4. After making any contour property changes, select **OK** to contour your surface.
5. Contour lines are applied to the surface at the interval specified in the contour dialog.

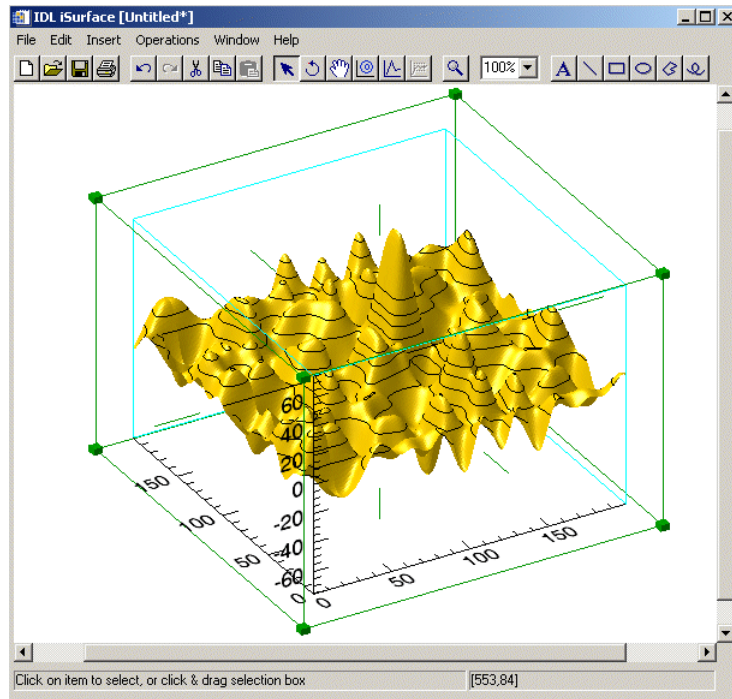



Figure 11-5: Surface with Contours Added

6. To adjust the properties of the contour, double-click the contour in the iTool window or in the Visualization Browser to display the Contour property sheet. For information on the contour properties, see “Contour” on page 432.

To insert a contour object at a specific location on a surface:

1. Select a surface in the iSurface window.
2. Click the Surface Contour button  in the Manipulator toolbar.
3. Click the level on the surface at which you would like the contour to appear. Contour lines are displayed on the surface at that level.
4. To adjust the properties of the contour object, double-click the contour object in the iTool window or in the Visualization Browser to display the Contour property sheet. For information on the contour properties, see “Contour” on page 432.

# Resampling a Surface

Once surface data has been imported into the iSurface window, that data can be re-imported using different import parameters by *resampling* the data. See “Resample” on page 117 for details.

To resample a surface:

1. Select a surface in the iSurface window. For example, select the `isurfdemo.dat` surfaced data.
2. Select **Operations** → **Transform** → **Resample**.

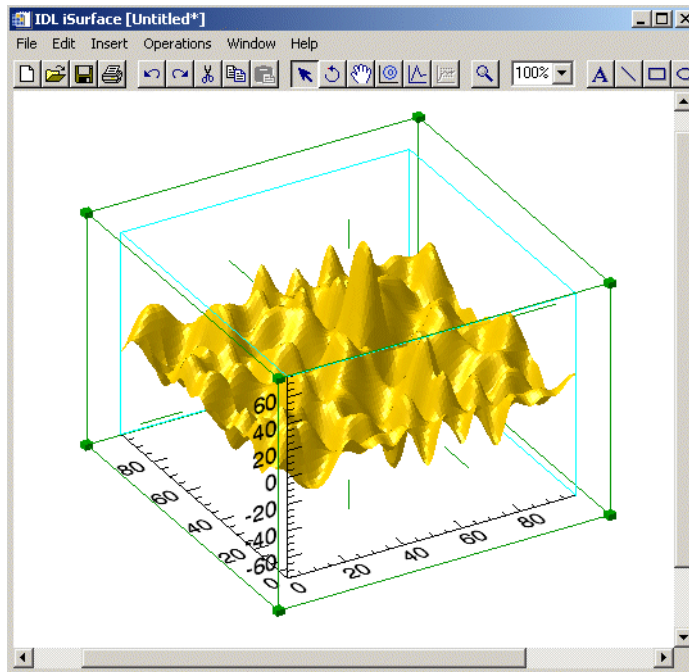

Figure 11-6: Resampled Surface in iSurface

# Filtering a Surface

Three types of filters are available in the iSurface tool: smooth filtering and convolution filtering.

## Convolving a Surface

To convolve a surface:

1. Select the surface to be convolved.
2. Select **Operations** → **Filter** → **Convolution**.

For details on using the convolution filter, see “[Convolution Filter](#)” on page 122.

## Median a Surface

The median filter replaces each point with the *median* (a value in an ordered set of values with an equal number of values above and below it) of the one- or two-dimensional neighborhood of a given width.

to median a surface:

1. Select the surface.
2. Select **Operations** → **Filter** → **Median**.

For details about using the median filter, see “[Median Filter](#)” on page 121.

## Smoothing a Surface

The smooth filter removes unwanted noise from a surface.

To apply the smooth filter to a surface:

1. Select the surface.
2. Select **Operations** → **Filter** → **Smooth**.

For details on using the smooth filter, see “[Smooth Filter](#)” on page 120.

## Adding a Texture Map

An image file can be imported into a surface visualization to serve as a *texture map*: an image projected onto the surface skin in place of the default red skin.

To add a texture map to a surface:

1. Select the surface.
2. Select **Edit** → **Parameters** to open the Parameter Editor.
3. Click **Import File** to import the image file to be used as a texture map into the Data Manager.
4. Find the image file in the list of files in the Data Manager tree and select either a specific image channel to import, or select **Image Planes** to import all channels of the image.
5. Click the **Assign Data** button  under TEXTURE. The name of the data to import appears in the TEXTURE field.

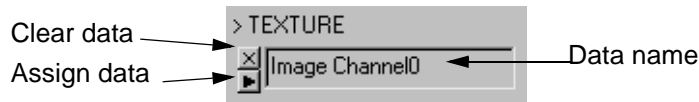

Figure 11-7: TEXTURE Field in Parameter Editor

6. Click **OK**. The Parameter Editor window closes, and the texture map appears on the surface.

# Manipulating Surface Displays

The iSurface tool provides options for manipulating surface data. You can rotate as well as scale surfaces. These manipulations are described in the following sections.

## Rotating a Surface

Rotation tools are provided in the iSurface tool to make it easier to see all aspects of a 3-D surface visualization. Surfaces can be rotated freely or along an axis with the mouse, and they can be rotated in fixed or arbitrary increments from the Operations menu.

To rotate a surface freely or along an axis with the mouse:

1. Select the surface in the iSurface window.
2. Click Rotate  on the Manipulator toolbar. The rotation sphere is displayed around the surface.

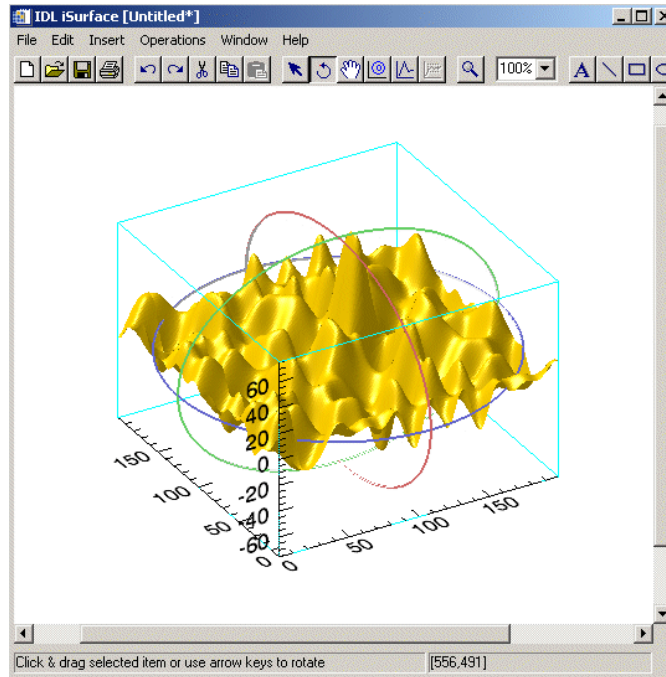



Figure 11-8: Surface with Rotation Sphere Displayed

- To rotate the surface freely, position the mouse pointer over the surface so that it changes to a free rotation pointer . Click and drag to rotate the surface in the desired direction.
- To rotate the surface along an axis, position the mouse pointer over an axis so that it changes to an axis rotation pointer . Click and drag to rotate the surface along the axis in the desired direction.

To rotate a surface in 90° increments left or right from the Operations menu:

1. Select the surface in the iTool window.
2. Select **Operations** → **Rotate** → **Rotate Left** or **Operations** → **Rotate** → **Rotate Right**.

To rotate a surface an arbitrary number of degrees from the Operations menu:

1. Select the surface in the iTool window.
2. Select **Operations** → **Rotate** → **Rotate by Angle**.



3. In the Rotate Angle dialog, enter the desired number of degrees to rotate the surface.

For more information, see “Rotation” on page 113.

## Scaling a Surface

Surfaces can be scaled freely, or scaling can be constrained to one or more dimensions.

To scale a surface freely:

1. Select the surface in the iTool window.
2. Position the mouse pointer over a side of the data set bounding box so that it changes to an unconstrained scaling pointer .
3. Click and drag to scale all points of the surface in the desired direction.

To constrain scaling of a surface:

1. Select the surface in the iTool window.
2. Position the mouse pointer over an axis “whisker” to scale along only one axis, or over a corner of the bounding box for multi-axis scaling.

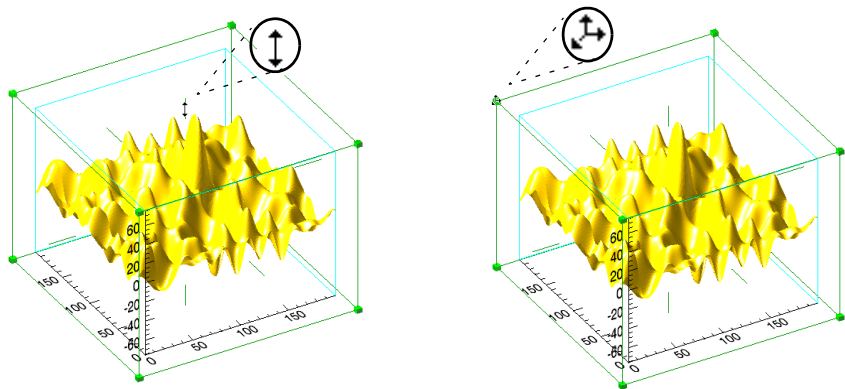

Figure 11-9: Constrained Single-Axis (left) and Multi-Axis (right) Scaling

3. Click and drag to scale in the desired direction.

For more information, see “Scaling” on page 65.

## Adding Annotations

Annotations can be added to label or describe surface visualizations displayed in the iSurface tool.

The following types of annotations can be added to iSurface displays:

| Plot Annotation Type | Description   |
|----------------------|---|
| Text                 | Single lines or multiple lines of text can be added to a visualization to provide a label or description.     |
| Line                 | Straight line annotations can be added to a visualization to link labels to objects or to identify an object. |
| Rectangle            | Rectangular annotations can be added to a visualization to identify rectangular areas.                        |
| Oval                 | Oval annotations can be added to a visualization to identify elliptical areas.                                |
| Polygon              | Polygon annotations can be added to a visualization to identify areas bounded by a polygon.                   |
| Freehand             | Freehand annotations can be added to a visualization to identify an area.                                     |

*Table 11-1: Types of Surface Annotations*

For more information on creating and using annotations, see [Chapter 5, “Adding Annotations”](#).

## View Zoom

View Zoom allows you to zoom in or out on a specific area of the surface display area. To zoom in or out in View Zoom mode click Zoom  on the toolbar. For more information on working with View Zoom, see [“Zooming”](#) on page 70.

## Canvas Zoom

Canvas Zoom allows you to increase or decrease the magnification of the entire display canvas (which may contain multiple views, depending on the layout) by a

specified percentage. Canvas Zoom is available by selecting the pull-down percentage list from the top of the tool just under the Help menu. For more information on working with Canvas Zoom, see “[Zooming](#)” on page 70.

## Extracting a Line Profile

To extract a line profile of part of your surface visualization in an iPlot window:

1. Click on the **Line Profile** icon on the iSurface window toolbar.
2. Use the mouse to position the jagged-edge line profile tool over the place which you wish your line profile to begin.
3. Drag to the ending point of your line profile.
4. The profile plot appears in an iPlot window.

Once a line profile has been drawn, it will remain until deleted. The line may be translated (or its endpoints moved individually) by switching back to the arrows. If it is translated or edited, the profile plot will automatically update.

# iSurface Tool Operations

The iSurface tool provides the following operations:

## Viewing a Histogram Plot

To display a histogram plot of your surface:

1. Select the surface.
2. Select **Operations** → **Histogram**.

For more information, see [“Plotting a Histogram”](#) on page 126.

## Viewing Statistics

To display the Statistics dialog:

1. Select an object or a group of objects in the iTools window.
2. Select **Operations** → **Statistics**. The Statistics window displays the statistics for the selected object(s).

For more information, see [“Displaying Statistics”](#) on page 127.



## Chapter 12

# Working with Contours

This chapter describes how to work with contours in the iContour tool.

---

|                                   |     |  |     |
|-----------------------------------|-----|--|-----|
| Introduction .....                | 254 | Adding a Colorbar .....                | 269 |
| Displaying Contours .....         | 255 | Adding a Legend .....                  | 270 |
| Contour Properties .....          | 262 | Adding Axes .....                      | 271 |
| Labelling Contours .....          | 264 | Filtering a Contour .....              | 272 |
| Changing the Contour Colors ..... | 266 | Manipulating the Contour Display ..... | 274 |
| Filling Contours .....            | 267 | iContour Tool Operations .....         | 277 |

# Introduction

The IDL iContour tool allows you interactive access to contour data. You may visualize contours and then modify and manipulate those contours in the ways that you need.

The IDL iContour tool displays your data as contours and allows you great flexibility in manipulating and visualizing these contours. The iContour tool can be used for irregular or regular grid data. Irregularly-grid data arranged as three fields (three one-dimensional vectors) are gridded by a Gridding Wizard if this data is imported into the iTool. Regular grid data arranged as a two-dimensional array is directly imported.

To use iContour from the IDL Command Line, type `iContour`. An empty iContour tool appears. You can then import contour data using any of several data import methods. For more information on importing contour data, see [Chapter 2, “Importing and Exporting Data”](#).

---

**Note**

For more information on accepted arguments and keywords, see “**ICONTOUR**” in the *IDL Reference Guide* manual.

---

The iContour tool can be launched in the following ways:

- At the IDL Command Line without arguments or keywords
- At the IDL Command Line with arguments and keywords
- Through the **File** → **New** → **Visualization** → **iContour** menu option in the IDL Development Environment
- Through the **File** → **New** → **iContour** menu option in an existing iTool

# Displaying Contours

The iContour tool's primary purpose is to display contours, though the tool is capable of much more once the data is displayed. The iContour tool can display regular-grid data or irregular-grid data. Gridding is the creation of uniformly-spaced planar data from data points. These points may initially be irregular.

## Displaying Regular-grid Data

Regular-grid data points are presented by two-dimensional arrays. The following example shows one way of importing and displaying this type of data into the iContour tool. The 248-by-248 two-dimensional array contained within the `convec.dat` binary file in the `examples/data` directory is imported into IDL with the `READ_BINARY` function. The iContour tool then displays this data as contours.

At the IDL Command Line, enter:

```
file = FILEPATH('convec.dat', SUBDIRECTORY = ['examples', 'data'])
data = READ_BINARY(file, DATA_DIMS = [248, 248])
iContour, data
```

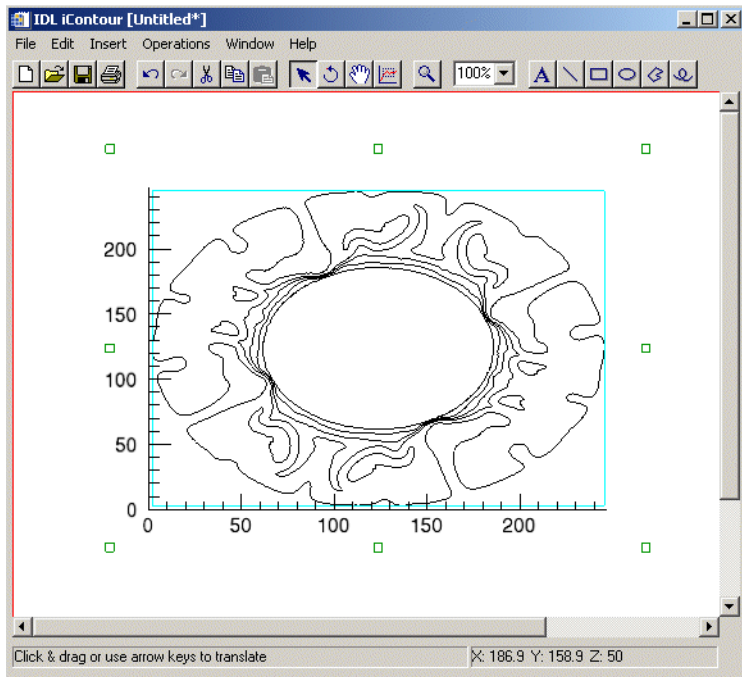

Figure 12-1: Earth Convection Contours in the iContour Tool

---

### Note

The `examples/data` directory of your IDL 6.2 distribution contains a text file named `index.txt`. This file lists all data files available in the example directory and also lists their dimensions and values.

---

## Displaying Irregular-grid Data

Irregular-grid data points are presented by three one-dimensional vectors, usually known as fields. The following example shows one way of importing and displaying this type of data into the iContour tool. The three fields contained within the `irreg_grid1.txt` ASCII file in the `examples/data` directory is imported into IDL with the **File** → **Open** option in the iContour tool. This option uses the ASCII Template wizard to import the data, which is then gridded into contour data with the Gridding Wizard. The iContour tool then displays this data as contours.



1. At the IDL Command Line, enter:

```
ICONTOUR
```

2. Select **File** → **Open** from the pulldown menus of the empty iContour tool. The Open dialog will appear.
3. Use the Open dialog to find and select the `irreg_grid1.txt` file in the `example/data` directory. The ASCII Template wizard will appear.

The `irreg_grid1` file contains three columns of data points. These columns represent the  $x$ -locations,  $y$ -locations, and the elevation (respectively) of this data. These columns are specified as three fields (vectors) of data with the ASCII Template wizard.

4. Click **Next** on the first and second step of the wizard, then click **Finish** on the third (last) step of the wizard. The **IDL iTools Create Visualization** dialog will appear.

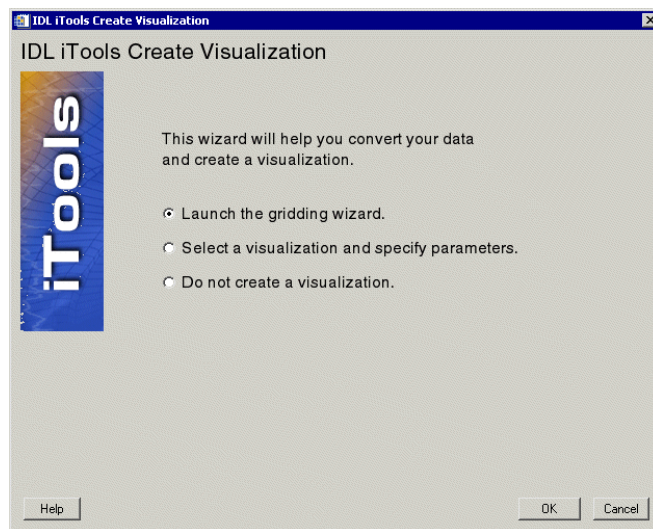

Figure 12-2: The iTools Create Visualization Dialog

The **IDL iTools Create Visualization** dialog contains the following choices:

- Launch the gridding wizard
- Select a visualization and specify parameters

- Do not create a visualization
5. Select the **Launch the gridding wizard** radio button, then click **OK**. The **IDL Gridding Wizard Step 1 of 3** dialog will appear.

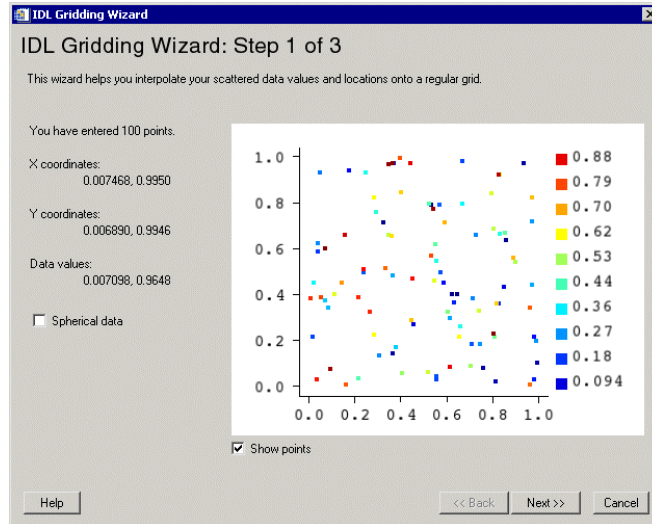

Figure 12-3: The IDL Gridding Wizard Step 1 of 3

The Gridding Wizard allows you to specify the method of gridding while showing you the possible results for that method. The **IDL Gridding Wizard Step 1 of 3** dialog contains the following items:

- **Number of points entered**
- **X Coordinates** — X coordinate range
- **Y Coordinates** — Y coordinate range
- **Data values** — Data values are shown here
- **Spherical data checkbox** — Check to make data spherical
- **Coordinate diagram** — Shows coordinates of grid data
- **Show points checkbox** — Select to show all points (default is checked)
- **Help** — Obtain help on this dialog
- **Back** — Return to previous step

- **Next** — Proceed to Step 2 of 3
  - **Cancel** — Dismiss the Gridding Wizard
6. In the Gridding Wizard Step 1, click **Next** to accept the interpolation of data values and locations. The **IDL Gridding Wizard Step 2 of 3** dialog will appear.



Figure 12-4: The IDL Gridding Wizard Step 2 of 3

The **IDL Gridding Wizard Step 2 of 3** dialog contains the following items:

- **X Coordinates** — modify dimension, start or end
- **Y Coordinates** — modify dimension, start or end
- **Coordinate diagram** — Shows coordinates of grid data
- **Show points checkbox** — Select to show all points (default is checked)
- **Help** — Obtain help on this dialog
- **Back** — Return to previous step
- **Next** — Proceed to Step 3 of 3
- **Cancel** — Dismiss the Gridding Wizard

7. At Step 2, click **Next** to accept the dimensions, start and spacing. The **IDL Gridding Wizard Step 3 of 3** dialog will appear.

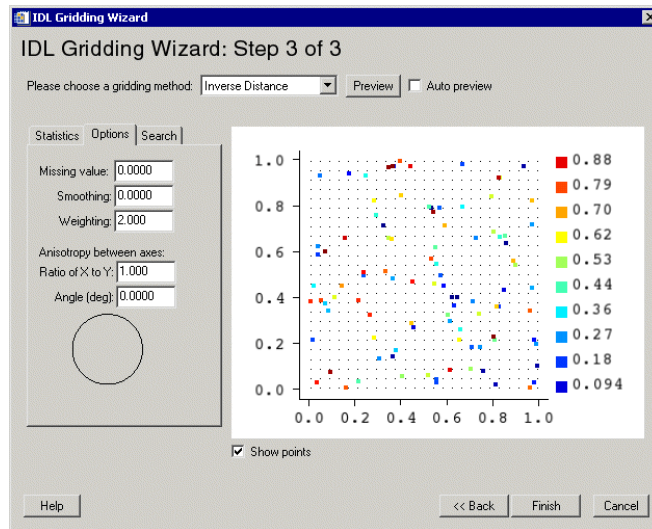

Figure 12-5: The IDL Gridding Wizard Step 3 of 3

The **IDL Gridding Wizard Step 3 of 3** dialog contains the following items:

- **Choose gridding method** — Choose from pull-down list of methods
- **Preview** — Click to preview selected method and data
- **Auto preview** — Checkbox to turn auto preview on (default = off)
- **Statistics tab** — Shows data statistics
- **Options tab** — Set options for missing values, smoothing, weighting, and anisotropy between axes
- **Search tab** — Set options for using search ellipse
- **Coordinate diagram** — Shows coordinates of grid data
- **Show points checkbox** — Select to show all points (default = checked)
- **Help** — Obtain help on this dialog
- **Back** — Return to previous step

- **Finish** — Dismiss the Gridding Wizard with data gridded
  - **Cancel** — Dismiss the Gridding Wizard
8. At Step 3, select **Inverse Distance** as the gridding method and click **Finish** to display the surface.
  9. The resulting contours are displayed in the iContour tool.

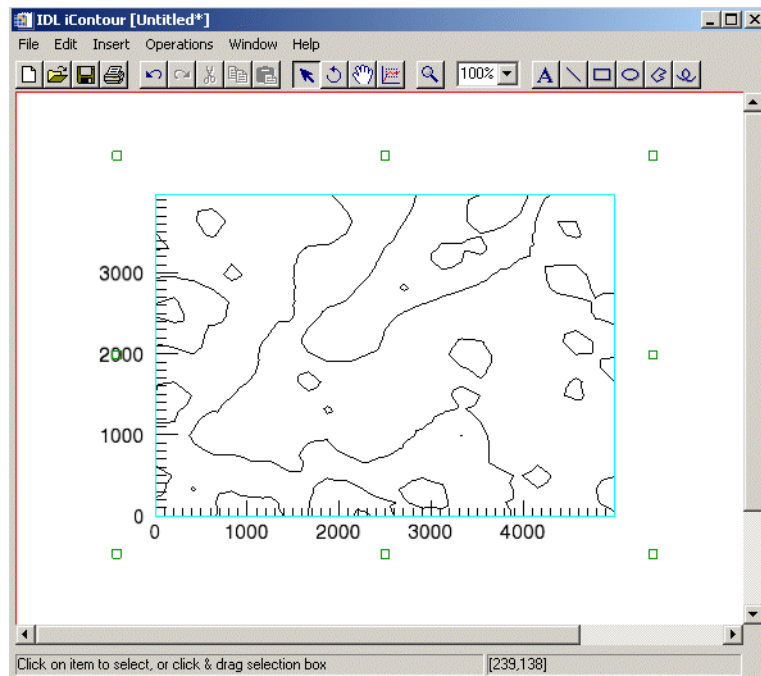
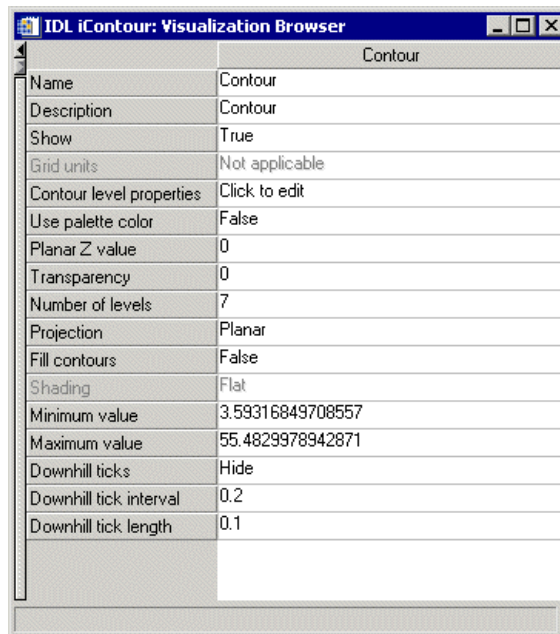

Figure 12-6: Irregular-grid Elevation Contours in the iContour Tool

# Contour Properties

The iContour window is a self-contained contour display and manipulation device. You can import and export contour data, and modify and manipulate contours. For more information on the basic iContour interface and its layout, see [Appendix A, “iTools Interface Reference”](#).

With the contour selected, the **Edit** → **Properties...** option allows access to the contour property sheet. You can change many contour properties through this sheet.



*Figure 12-7: Contour Property Sheet*

The following examples show how to modify some contour properties. These examples are performed on the contours imported by using the following steps:

1. At the IDL Command Line, enter:  

```
ICONTOUR
```
2. Select **File** → **Open** from the pulldown menus of the empty iContour tool. The Open dialog will appear.

3. Use the Open dialog to find and select the `convect.dat` file in the `example/data` directory. The Binary Template wizard will appear.
4. In the Binary Template dialog, click **New Field**, and enter the following information in the New Field dialog:
  - **Field name:** `data` (or a name of your choosing)
  - **Type:** `byte`
  - **Number of dimensions:** 2
  - **1st dimension Size:** 248
  - **2nd dimension Size:** 248
5. Click **OK** to close the New Field dialog and the Binary Template dialog, and the contours are displayed in the tool.

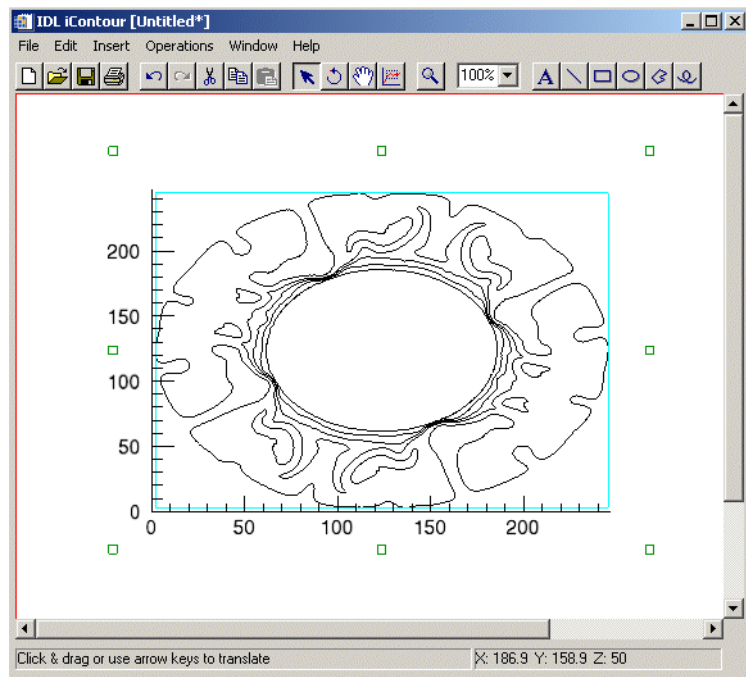

Figure 12-8: Earth Convection Contours in the iContour Tool

# Labelling Contours

Each contour level line has its own properties. You can access these properties through **Contour level properties** in the contour property sheet by clicking **Contour level properties**, clicking on the arrow button, and then clicking **Edit...** The Contour Levels property sheet will appear.

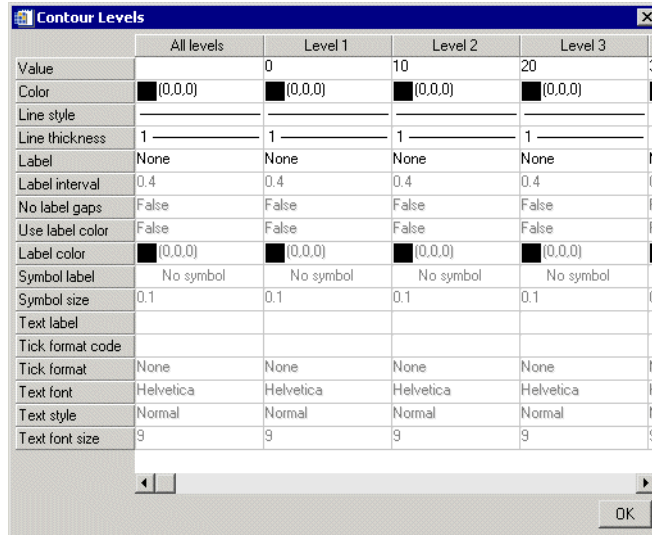

Figure 12-9: Contour Levels Property Sheet



The first column of the Contour Levels property sheet contains the property values for all the levels. In this column, change the **Label** setting from `None` to `Value`. The value of each contour line appears as labels in the iContour display.

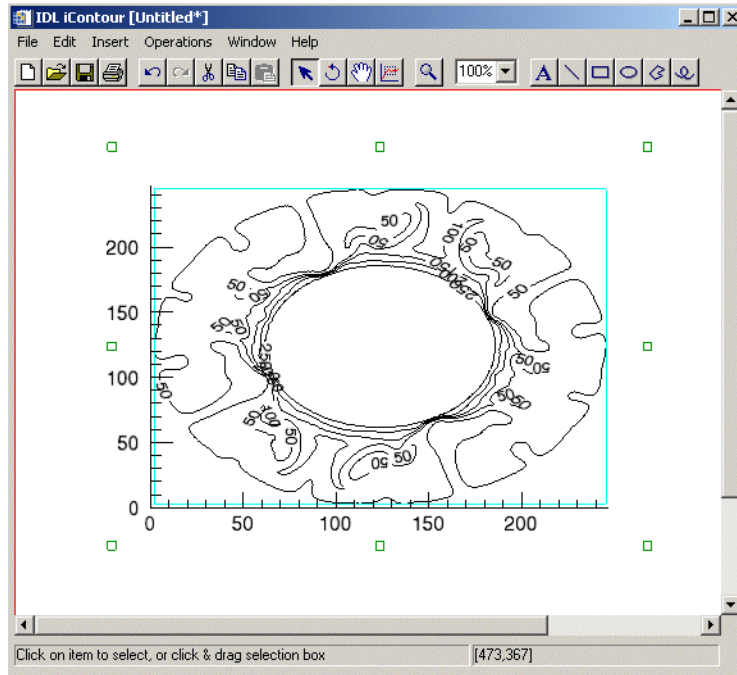
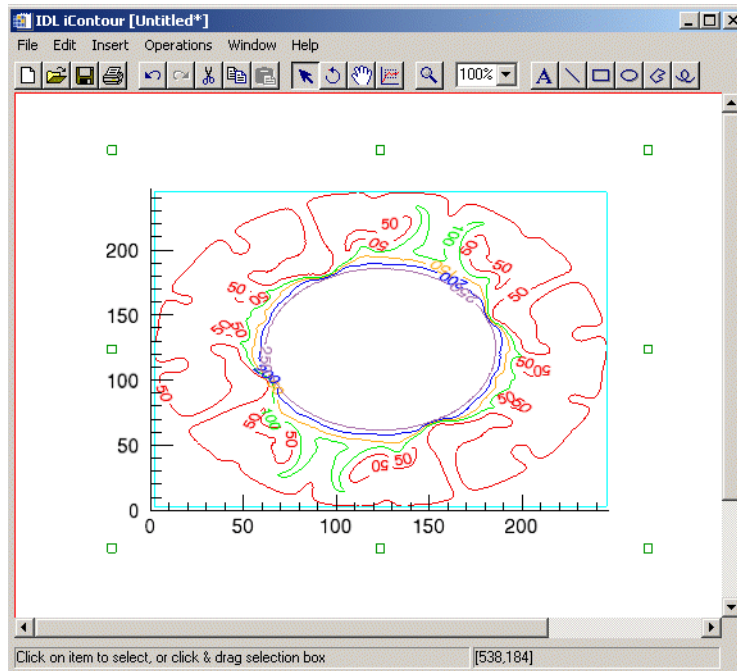

Figure 12-10: Labelled Contour Levels

# Changing the Contour Colors

The columns after the first one are for each individual contour level. In each level column, change the Color setting from black to a different color making sure to use a different color for each level. When a level color is changed in the property sheet, that level is updated in the iContour display.

The resulting display contains a different color contour for each level.



*Figure 12-11: Color Contour Levels*

After changing the colors of each level, click **OK** in the Contour Levels property sheet. The Contour Labels property sheet closes.

# Filling Contours

The Fill contours setting in the original contour property sheet controls whether the contour levels are filled or not. Change the **Fill contours** setting to `True`.

## Note

You must also change the **Use palette color** setting to `True` as well before colors can be used. After that, you can choose or set your own color scheme from the **Levels Color Table** → **Edit color table** function.

The contour colors are now more distinctive.

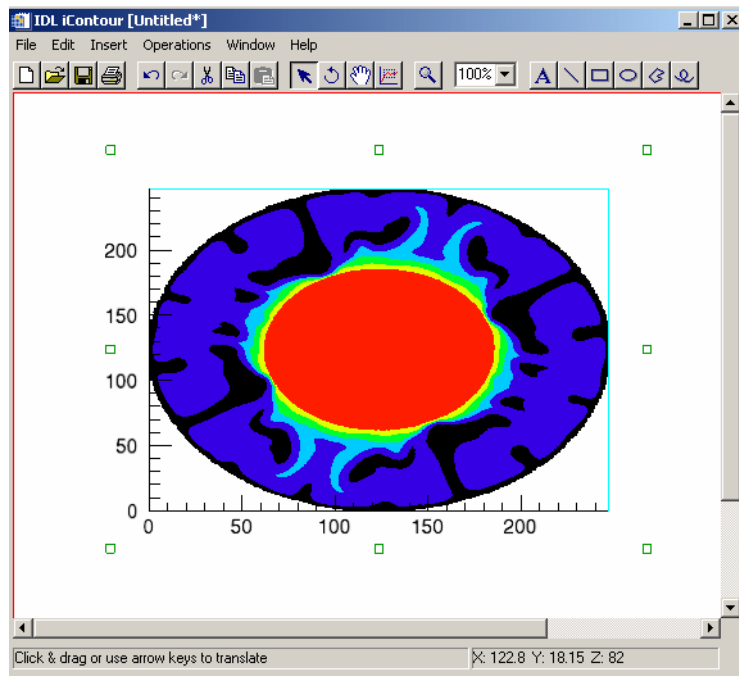

Figure 12-12: Filled Contour Levels Using the Predefined Blue Waves Scheme

Even more detail can be added by increasing the number of levels in the contour display. Change the **Number of levels** from 6 to 20.

The color set for each of the original seven levels is repeated every set of seven within the 20 new levels.

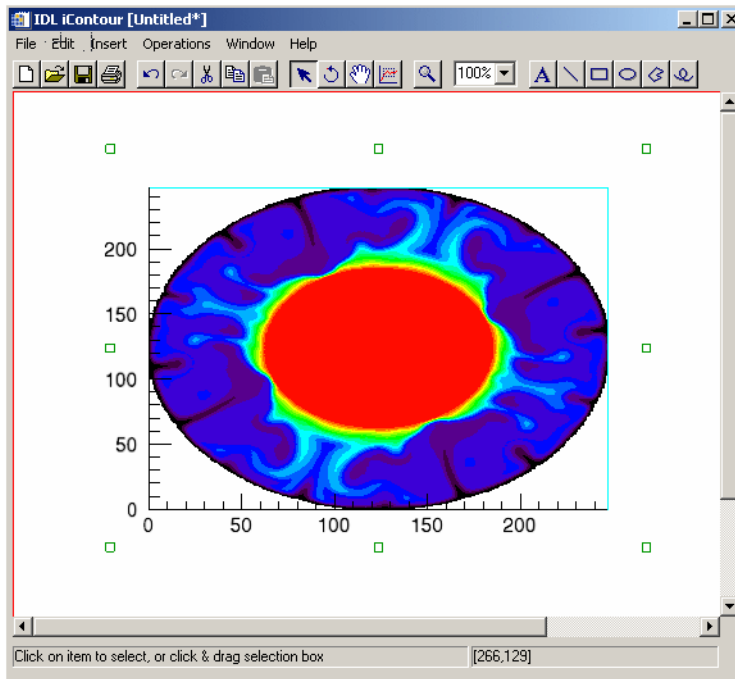

Figure 12-13: 20 Filled Contour Levels Reset at 20 Levels

## Adding a Colorbar

You can add a colorbar to your visualized contour which will show on a color scale the minimum to maximum values of data in the visualization. To add a colorbar, click on the contour data and then from the iContour window, select **Insert** → **Colorbar**. A colorbar will be placed in the visualization window.

---

**Note**

Be sure that the **Use palette color** setting in the Visualization Browser is `True` so that colors can be used. After that, you can choose or set your own color scheme from the **Levels Color Table** → **Edit color table** function.

---

This colorbar can be resized and moved around the data space. You can also double-click on the colorbar to invoke the Visualization Browser which will allow you to change the values for the colorbar and edit color tables. For more information on the colorbar, see “[Colorbar](#)” on page 450.

# Adding a Legend

You can add a legend to your contour which shows the levels of the contour in their increments. To add a legend, select **Insert** → **New Legend** from the iContour tool window.

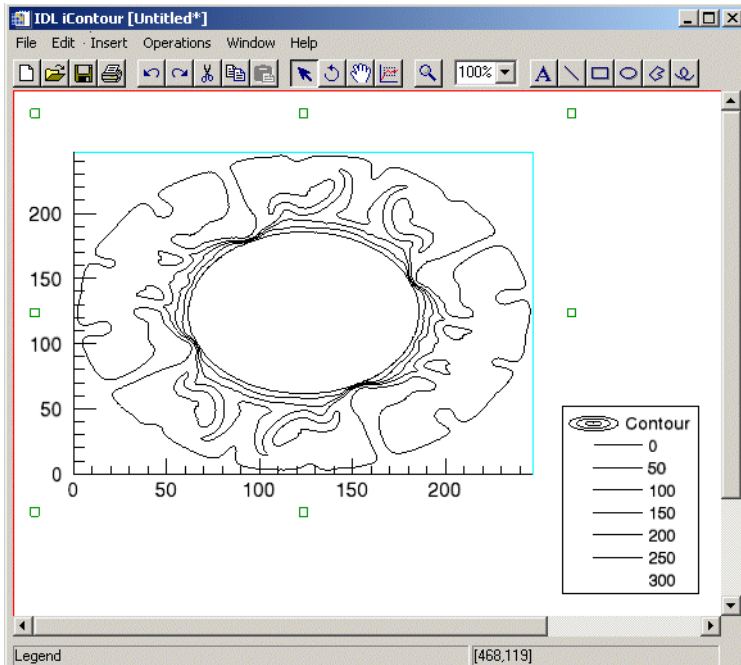
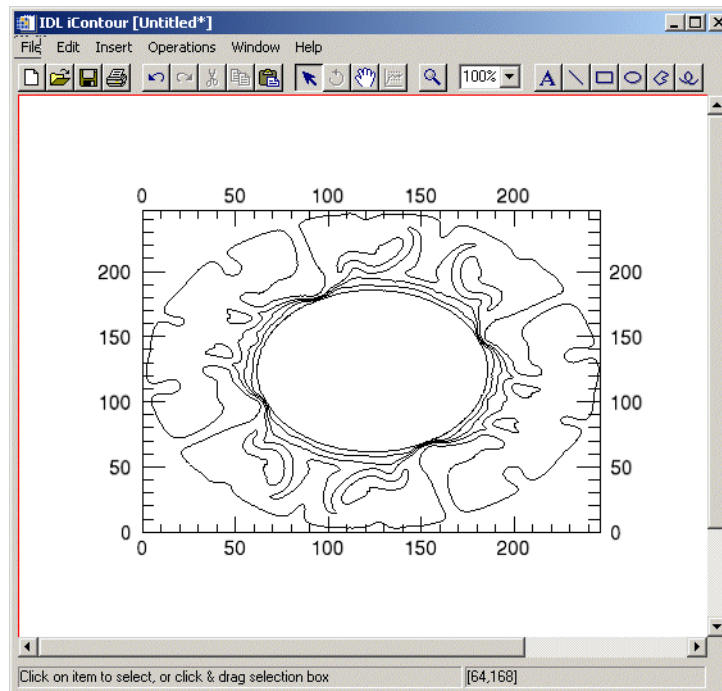

*Figure 12-14: A Contour With Legend Added Showing Levels*

Once you have placed a legend on your contour, you can edit the legend settings such as the title and level increments as well as the color options on the legend. Double-clicking on the legend itself will show you the Visualization Browser. For more information on the options available, see [“Legend Properties”](#) on page 491.

## Adding Axes

You can also add axes to your contour as visual aids for reading contour data. Although axes are added to two- and three-dimensional contour data there are advantages to adding additional axes. For example in the figure which follows, additional axes have been added in order to create a box-style contour showing the tick marks and increments on all sides of the image. You can add X, Y and Z axes depending on your contour and needs. To insert axes, select **Insert** → **Axis** and then select **X Axis**, **Y Axis**, or **Z Axis** or from the Visualization Browser, select the **Axes** group and then set **Style** to **Box Axes**.



*Figure 12-15: A Contour With Axes Added and Altered in Box-Style*

Once you have placed an axis on your contour you can edit the axis settings by changing the title and increments as well as the color options on the axis. Double-clicking on the axis itself will show you the Visualization Browser.

# Filtering a Contour

The iContour tool allows you to modify your contour data in the following ways:

## Contour Smoothing

Within the iContour tool, contours can also be smoothed to refine edges or compensate for random noise in the data. To smooth your data from the iContour window, select **Operations** → **Filter** → **Smooth**.

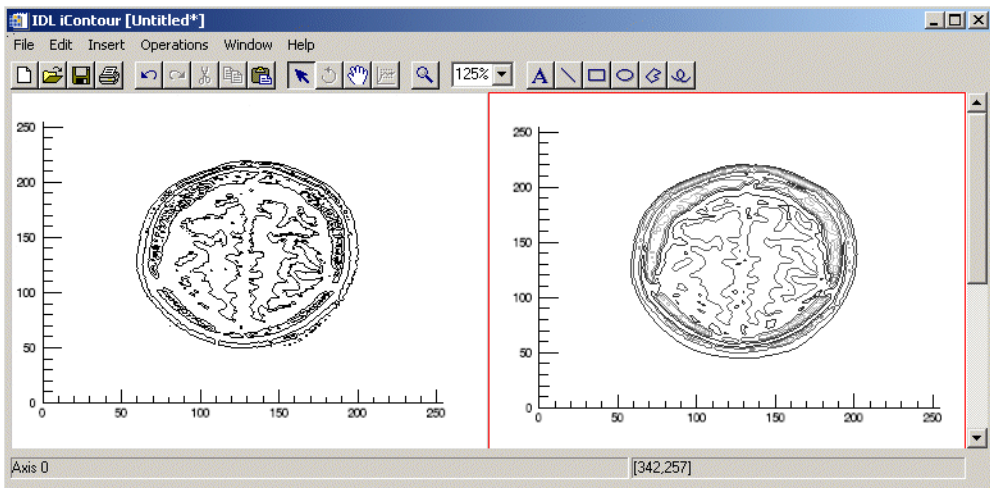

Figure 12-16: Brain MRI Data (left) and Smoothed Data (right)

---

### Note

The previous figure shows brain MRI data taken from the IDL `examples\data` directory in a file named `mr_brain.dcm`.

---

### Note

The window's default size is three, however this can be changed via the operations browser. For more information on smoothing properties, see [“Smooth Properties”](#) on page 383.

---



## Contour Convolution

You can also use iContour convolution feature by selecting **Operations** → **Filter** → **Convolution**. By selecting this, the **Convolution Editor** appears.

From this dialog, you can select the desired convolution type from a drop-down list or you may manipulate the columns and rows and scale factor and details manually. For more details on the convolution filter, see “[Convolution Filter](#)” on page 122.

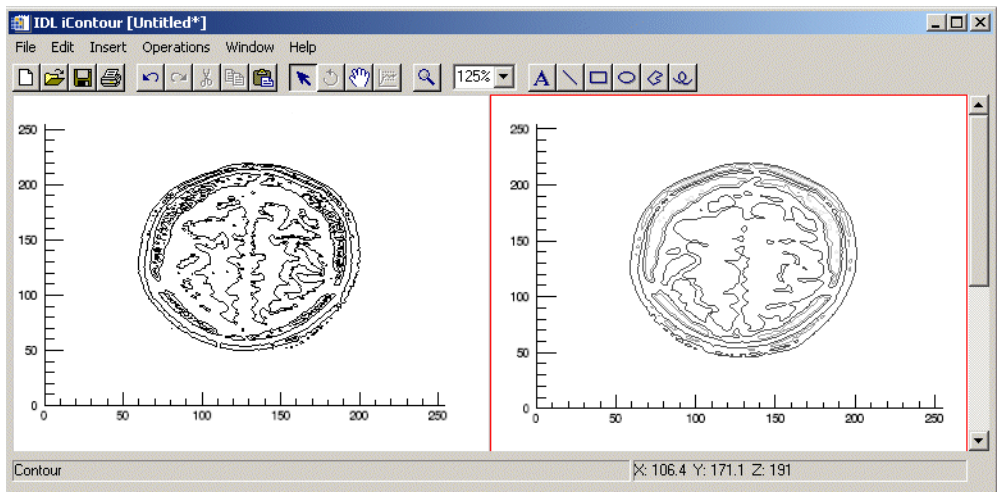

Figure 12-17: Brain MRI Data (left) and Convolved (right) Using Gaussian Convolution

For more information on convolution properties, see “[Convolution Properties](#)” on page 380.

# Manipulating the Contour Display

The iContour tool allows you many options to manipulate your existing plot displays. Once you have visualized your contours, you may rotate, flip, translate, scale, and zoom as well as modify contour properties, scroll, and select contour ROIs. The following options are available for manipulating contours.

## Translating

Translation moves an object or group of objects in a specific direction. When an object is selected, a bounding box appears around the object. For information on translating objects, see “[Translation](#)” on page 64.

## View Zoom

View Zoom allows you to zoom in or out on a specific area of the contour display area. To zoom in or out in View Zoom mode click **Zoom**  on the toolbar. For more information on working with View Zoom, see “[Zooming](#)” on page 70.

## Flipping a Contour

You can flip your contour within the data space either horizontally or vertically. These operations flip the actual data associated with the contour. To flip your data, select **Operations** → **Flip** → **Flip Horizontal** or **Operations** → **Flip** → **Flip Vertical**.

## Canvas Zoom

Canvas Zoom allows you to increase or decrease the magnification of the entire display canvas (which may contain multiple views, depending on the layout) by a specified percentage. Canvas Zoom is available by selecting the pull-down percentage list from the top of the tool just under the Help menu. For more information on working with Canvas Zoom, see “[Zooming](#)” on page 70.

## Scaling a Contour Display

The iContour tool allows you to scale your contour data by selecting **Operations** → **Transform** → **Scale Data**. You can scale your data by a factor which you provide in the **Scale Factor** dialog.

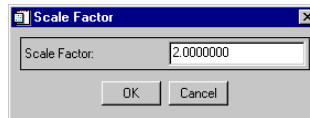

Figure 12-18: Setting the Contour Scale Factor

Once you have set the scale factor, select **OK** and the scaling takes place.

You may zoom in and out from your plot using either the Zoom In and Zoom Out buttons on the iPlot toolbar, or by selecting **Window** → **Zoom In** or **Window** → **Zoom Out**.

## Adding Annotations

The following types of annotations can be added to iContour displays:

| Plot Annotation Type | Description   |
|----------------------|---|
| Text                 | Single lines or multiple lines of text can be added to a visualization to provide a label or description.     |
| Line                 | Straight line annotations can be added to a visualization to link labels to objects or to identify an object. |
| Rectangle            | Rectangular annotations can be added to a visualization to identify rectangular areas.                        |
| Oval                 | Oval annotations can be added to a visualization to identify oval areas.                                      |

Table 12-1: Types of Contour Annotations

| <b>Plot Annotation Type</b> | <b>Description</b>  |
|-----------------------------|---|
| Polygon                     | Polygon annotations can be added to a visualization to identify areas bounded by a polygon. |
| Freehand                    | Freehand annotations can be added to a visualization to identify an area.                   |

*Table 12-1: Types of Contour Annotations*

For more information on creating and using annotations, see [Chapter 5, “Adding Annotations”](#).

# iContour Tool Operations

## Viewing a Histogram

A density histogram is a density plot showing the distribution of data values. The X-axis represents data values and the Y-axis represents density or frequency. Another type of histogram is a style plot histogram. To view a density histogram of contour data, use the iTool's histogram feature by selecting **Operations** → **Histogram**. For information on histogram creation, see [“Plotting a Histogram”](#) on page 126.

## Viewing Statistics

To view statistics for contour data, use the iTool's statistics feature by selecting **Operations** → **Statistics**. For information on viewing statistics, see [“Displaying Statistics”](#) on page 127.





# Chapter 13

# Working with Plots

This chapter describes plotting tasks and the iPlot tool.

---

|  |     |                                     |     |
|--|-----|-------------------------------------|-----|
| Introduction .....                       | 280 | Adding Legends .....                | 287 |
| Displaying Two-Dimensional Plots .....   | 281 | Adding a Colorbar .....             | 289 |
| Displaying Three-Dimensional Plots ..... | 282 | Adding Error Bars .....             | 290 |
| Displaying Polar Plots .....             | 283 | Curve Fitting .....                 | 292 |
| Overplotting .....                       | 284 | Filtering a Plot .....              | 295 |
| Plot Properties .....                    | 286 | Manipulating the Plot Display ..... | 297 |
| Adding Error Bars .....                  | 290 | iPlot Tool Operations .....         | 299 |

# Introduction

The IDL iPlot tool displays your data in plot form. The iPlot tool then allows you great flexibility in manipulating and visualizing plot data. iPlot can be used for any type of two- or three-dimensional plot, including scatter plots, line plots, polar plots, and histogram plots. To use iPlot, from the IDL Command Line, type `iPlot`. An empty iPlot tool appears. You can then import plot data using any of several data import methods. For more information importing plot data see [Chapter 2, “Importing and Exporting Data”](#).

---

**Note**

For more information on accepted arguments, see “**IPlot**” in the *IDL Reference Guide* manual.

---

The iPlot tool can be launched in many different ways:

- At the IDL Command Line without arguments or keywords
- At the IDL Command Line with arguments or keywords
- Through the **File** → **New** → **Visualization** → **iPlot** menu option in the IDL Development Environment
- Through the **File** → **New** → **iPlot** menu option in an iTool



# Displaying Two-Dimensional Plots

The iPlot tool's primary design is to display plot data, though the tool is capable of much more once the data is plotted. The iPlot tool can display multiple types of plots and allows you to manipulate and edit the displays.

The first task is to display plot data. Here is a simple example of how to display a plot.

At the IDL command line, enter:

```
iPlot, RANDOMU(seed, 20)
```

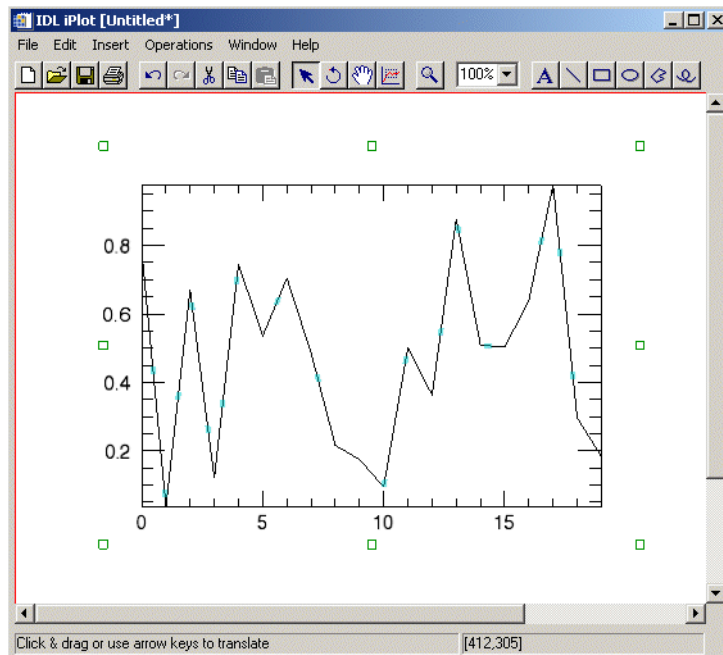

*Figure 13-1: A Simple 2D Plot Using the iPlot Tool*

---

**Note**

The `examples/data` directory of your IDL 6.2 distribution contains a text file named `index.txt`. This file lists all data files available in the example directory and also lists their dimensions and values.

---

# Displaying Three-Dimensional Plots

iPlot can display multiple types of plots and allows you to manipulate and edit the displays. You can also display three-dimensional plots. Here is a simple example of how to display a 3D plot.

At the IDL command line, enter:

```
iPlot, FINDGEN(20), FINDGEN(20), RANDOMU(seed, 20)
```

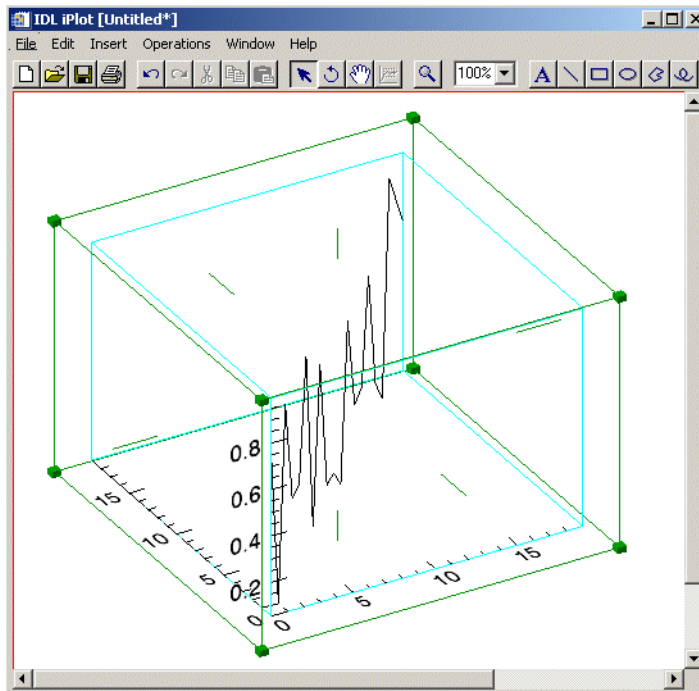

*Figure 13-2: A Simple 3D Plot Using the iPlot Tool*

# Displaying Polar Plots

iPlot can display multiple types of plots and allows you to manipulate and edit the displays. You can also display polar plots. Here is a simple example of how to display a polar plot.

At the IDL command line, enter:

```
iPlot, FINDGEN(20), FINDGEN(20), /POLAR
```

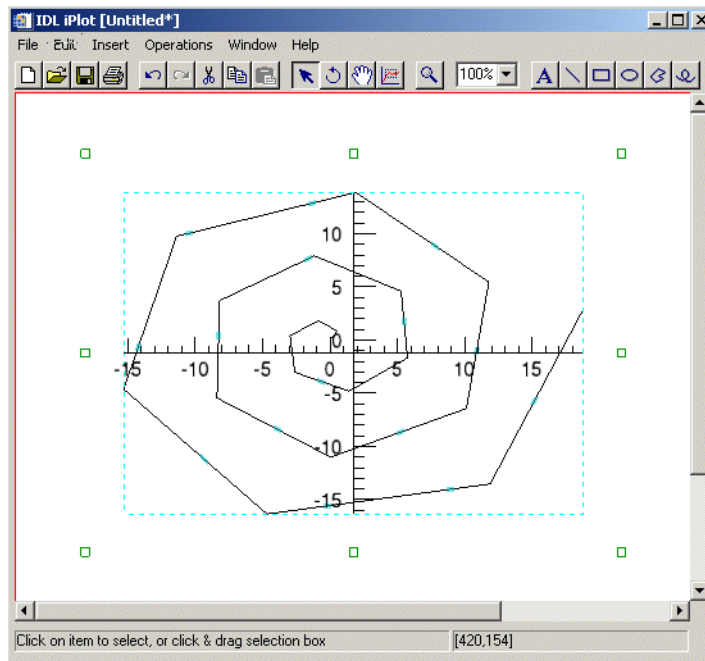

*Figure 13-3: A Simple Polar Plot Using the iPlot Tool*

---

**Note**

The `examples/data` directory of your IDL 6.2 distribution contains a text file named `index.txt`. This file lists all data files available in the example directory and also lists their dimensions and values.

---

# Overplotting

Once you have plotted data, you may overplot new plot data in the original iPlot window. Overplotting is the process of plotting new data over the top of original data or datasets for the purpose of analyzing or comparing more than one dataset at a time.

For example, in order to overplot cosine data onto a plot of sine wave data follow these steps:

1. Create a variable named “theory” to contain sine wave data to be plotted:

```
theory = SIN(2.0*FINDGEN(200)*!PI/25.0)*EXP(-0.02*FINDGEN(200))
```

2. Plot theory using iPlot:

```
iPlot, theory
```

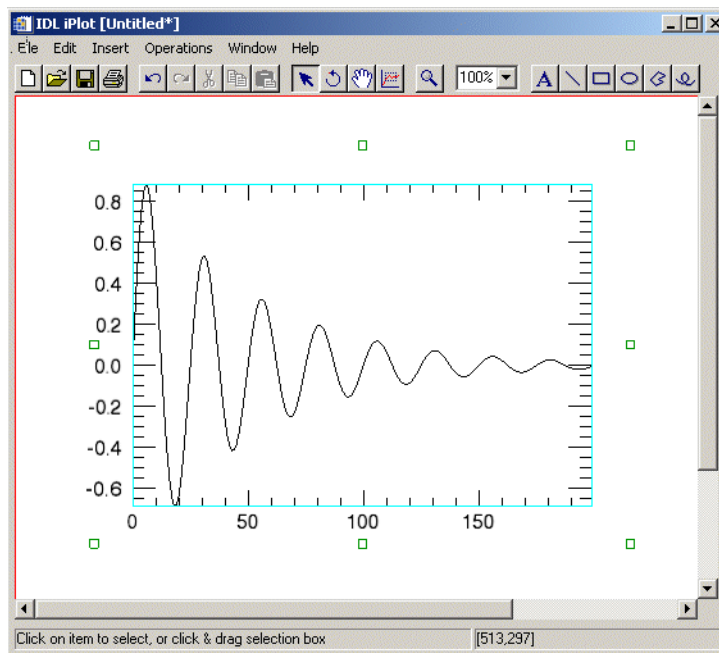

*Figure 13-4: Sin Wave Data Plotted*

3. Create a variable named “newtheory” which stores cosine data to be used for overplotting:

```
newtheory = COS(2.0*FINDGEN(200)*!PI/25.0)*EXP(-0.02*FINDGEN(200))
```

4. Now overplot the new cosine data onto your original plot:

```
iPlot, newtheory, /OVERPLOT
```

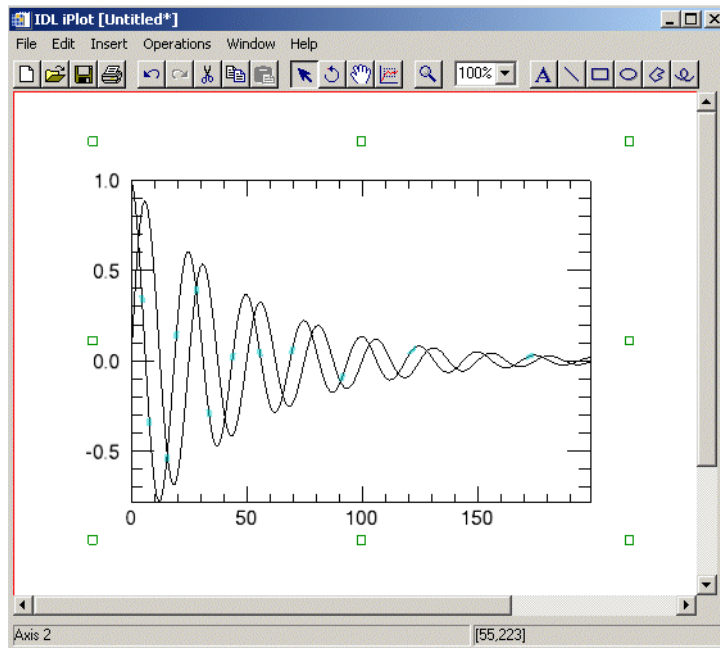

Figure 13-5: Cosine Data Overplotted on Sine Data

# Plot Properties

The iPlot window is a self-contained plot display and manipulation device. You can import and export plot data, and modify and manipulate plot data. For more information on the basic iPlot interface and its layout, see [Appendix A, “iTools Interface Reference”](#).

## Modifying Properties

By selecting **Edit** → **Properties** from the iPlot tool, you may modify your plot properties. You may modify your plot’s name, description, fill type and fill color, opacity as well as the show/hide properties and the line color, style and thickness. For more information on editing properties in the iTools, see [Appendix D, “Visualization Properties”](#).

# Adding Legends

A legend is text that describes aspects of a visualization. For example, a legend might show the plot line or plot points. If multiple plots are present the legend may show which colors and linestyles represent which plots. An inserted legend will include items selected at the time of insertion. If no specific dataset is selected, the legend will include all datasets in the plot.

To add a legend to your plot, select **Insert** → **New Legend**.

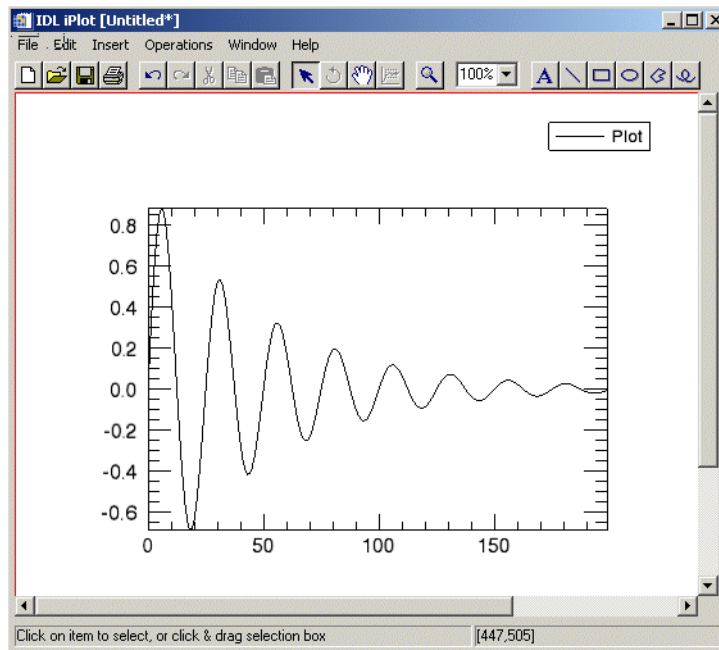

*Figure 13-6: A Simple Sine Plot with Default Legend Added*

You can add new information to your existing legend, or you can also use the **Insert** → **Legend** option can be used over again to add more legends. For example, in the theory plot with `newtheory` overplot displayed in the previous section, you can add a legend for each plot:

1. Select the `newtheory` plot by clicking once on the line.
2. Select **Insert** → **New Legend**. A new legend appears on top of the previous legend (this new legend can be selected and repositioned).

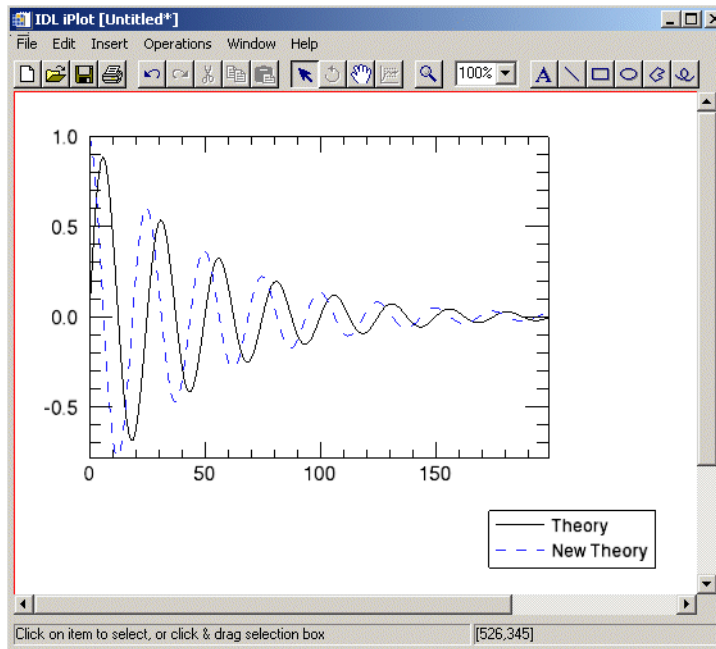

*Figure 13-7: Plot and Overplot in iPlot with Legend Added for Each*

You can double-click on the legend to bring up a property sheet to alter its settings. Through the property sheet, you can also access the Visualization Browser, which can be used to navigate through other legends and objects within the visualization. In the previous example the names of the legends have been altered to reflect the data names. For more information on editing settings in the Visualization Browsers, see [“The Visualization Browser”](#) on page 407.



## Adding a Colorbar

If you have added vertex coloring to your plot visualization, you can add a colorbar which will show on a color scale the minimum to maximum values of data in the visualization.

To add a colorbar,

1. Click on the plot data.
2. From the iPlot window, select **Insert** → **Colorbar**.
3. A colorbar will be placed in the visualization window.

This colorbar can be resized and moved around the data space. You can also double-click on the colorbar to invoke the Visualization Browser which will allow you to change the values for the colorbar. For more information on the colorbar, see “Colorbar” on page 450.

# Adding Error Bars

Error bars are used to show uncertainty in data values. These uncertainties may be caused by measurement errors or instrument noise, and are usually specified in terms of standard deviations away from the data value.

For example, to create a 2D plot with asymmetric error bars on the X and Y axes, follow these steps:

1. To set asymmetric error bars for X and Y with X bars initially hidden, enter:

```
err = FLTARR(2,10)
err[0, *] = FINDGEN(10)/10.
err[1, *] = FLTARR(10) + 0.5
```

2. Plot the error bars in the iPlot window:

```
iPlot, FINDGEN(10), COLOR = [255, 0, 255], $
  ERRORBAR_COLOR = [255, 0, 0], $
  ERRORBAR_CAPSIZE = 0.25, X_ERRORBARS = 0, $
  XERROR = err, YERROR = err
```

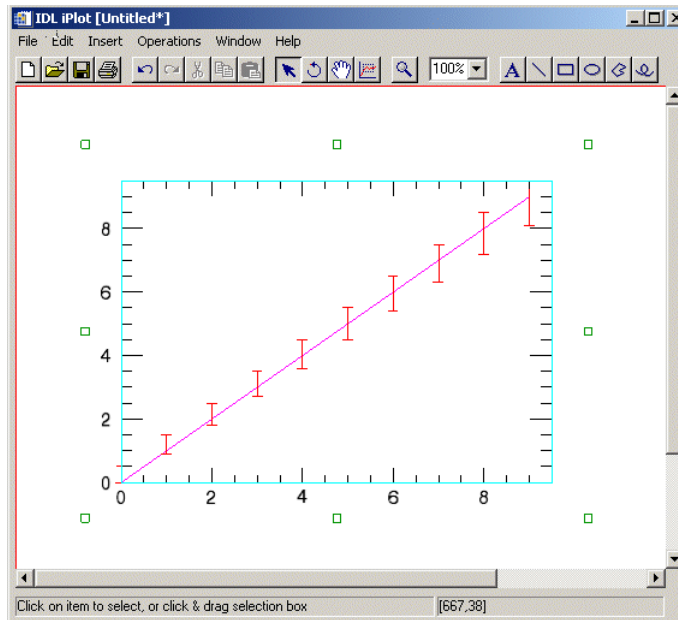

Figure 13-8: 2D Plot with Error Bars

Also, to create a 3D plot with asymmetric error bars on the X, Y and Z axes:

1. To set asymmetric error bars for a 3D plot, enter:

```
nVerts = 30
x = FINDGEN(nVerts)/10.
y = (SIN(x*2) + 1.)*25.
z = x
err = FLTARR(2, nVerts)
err[0, *] = RANDOMU(seed, nVerts)
err[1, *] = RANDOMU(seed, nVerts)
```

2. Plot the error bars in the iPlot window with 3D plot and name the plot “3D Plot with Error Bars”:

```
iPlot, x, y, z, COLOR = [0, 0, 255], $
  THICK = 2, ERRORBAR_COLOR = [255, 0, 0], $
  XERROR = err/2., YERROR = err*5., ZERROR = err, $
  NAME = '3D Plot with Error Bars'
```

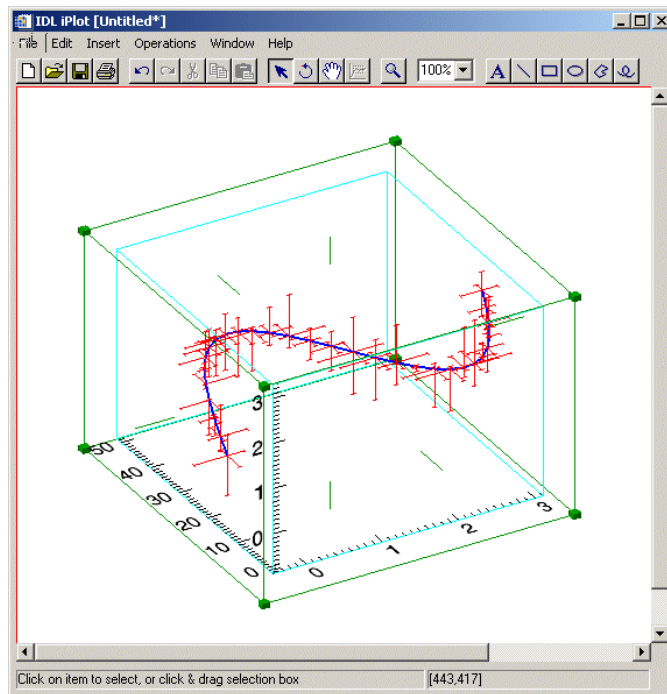

Figure 13-9: 3D Plot with Error Bars and Name

For more information on error-bar properties, see “Plot” on page 421.

# Curve Fitting

Curve fitting is the process of finding various ways to fit a curve to a series of data points which best represents all points. More specifically, since data, such as plot data, is often given as values along a continuum, you may wish at times to give estimates at points between values. Curve fitting allows you to find intermediate estimates for these values.

## Note

For both 2D and 3D plots, the curve fitting operation is performed on the X versus Y plot dimensions.

For example, to fit a curve to the damped sine plot we have already created:

1. Select **Operations** → **Filter** → **Curve Fitting**.
2. The Curve Fitting dialog appears.

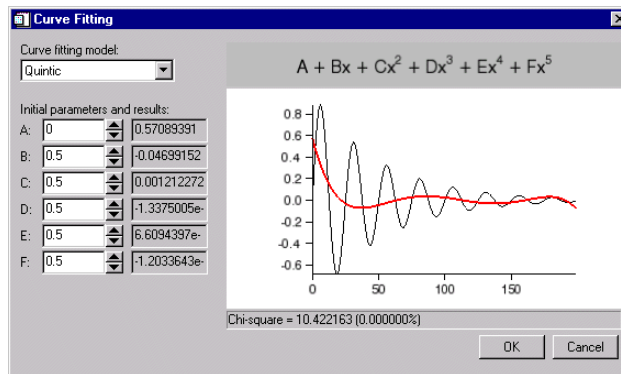

Figure 13-10: The Curve Fit Dialog with Curve Fitting Model Choices

The Curve Fitting dialog contains the following fields:

- **Curve fitting model** — used to select the type of model used to try to fit a curve to the data.
- **Initial parameters and results** — used to specify the initial values of the parameters of the model used to fit a curve to the data and to display the resulting values of these parameters for the model selected in the **Curve**

**fitting model** drop-down list. The initial values are specified in the text boxes on the left side and the results are shown in the labels on the right side.

- **Equation of the model** — shows the equation of the model used to try to fit a curve to the data. This model is selected from the **Curve fitting model**.
- **Display of resulting fit** — graphically shows how well the model specified by the **Curve fitting model** drop-down menu and the **Initial parameters** text boxes fits the data.
- **Chi-square value** — shows the resulting chi-square value, which is a measure of goodness-of-fit.

You can use this dialog to determine what type of model would best fit your data by changing the **Curve fitting model** drop-down menu setting and the **Initial parameters** text boxes values.

3. Select the desired curve fit from the **Curve fitting model** drop-down list. You can also set initial parameters if desired.

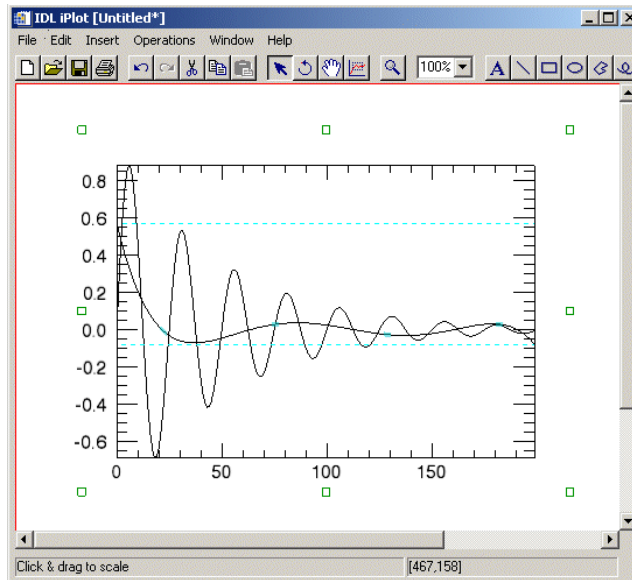

*Figure 13-11: A Quintic Curve Fit to a Sin Wave Plot*

The new curve created by the curve fitting operation is added to the Data Manager.

# Filtering a Plot

The iPlot tool allows you to modify your plot data in the following ways:

## Plot Smoothing

Within the iPlot tool, plots can also be smoothed to soften edges or compensate for random noise in the plot. To smooth your plot from the iPlot window, select **Operations** → **Filter** → **Smooth**.

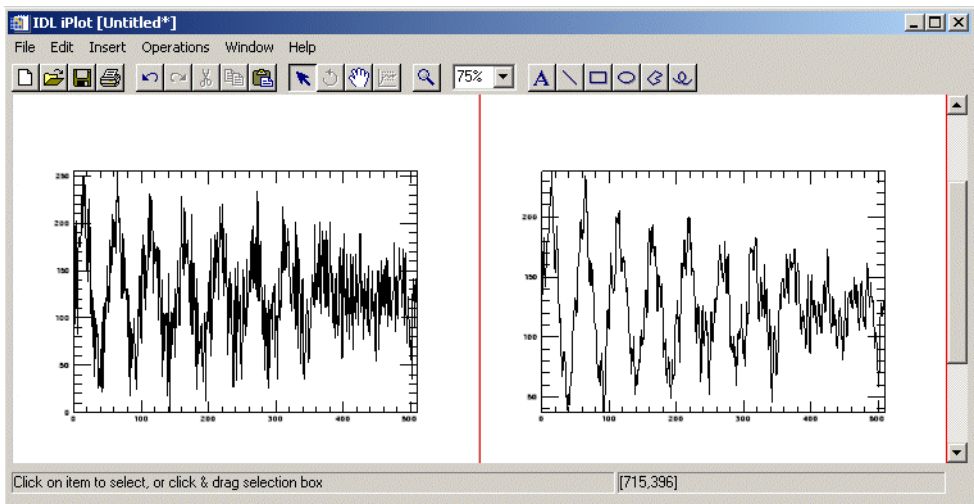

Figure 13-12: Damped Sine Plotted Data (left) and Smoothed Data (right)

---

### Note

The example shown in the previous figures is taken from example data available in the `examples\data` directory of your IDL installation. The data is contained in a file called `damp_sn.dat`.

---

### Note

The window's default size is three, however this can be changed via the operations browser. For more information on smoothing properties, see [“Smooth Properties”](#) on page 383.

---

## Plot Convolution

You can also use the iPlot convolution feature by selecting **Operations** → **Filter** → **Convolution**. By selecting this, the **Convolution Editor** appears. From this dialog, you can select the desired convolution type from a drop-down list or you can manually manipulate the columns, rows, scale factor, and details.

For more information on convolution properties, see “[Convolution Properties](#)” on page 380.

## Plot Median

The median filter replaces each point with the *median* (a value in an ordered set of values with an equal number of values above and below it) of the one- or two-dimensional neighborhood of a given width.

To apply the smooth filter to an image:

1. Select the plot.
2. Select **Operations** → **Filter** → **Median**.

For more details on the median filter, see “[Median Filter](#)” on page 121.



# Manipulating the Plot Display

The iPlot tool allows you many options to manipulate your existing plot displays. Once you have visualized your plot data, you may rotate, flip, translate, scale, and zoom as well as modify plot properties, scroll, and select plot ROIs. The following options are available for manipulating plots.

## Translating

Translation moves an object or group of objects in a specific direction. When an object is selected, a bounding box appears around the object. For information on translating objects, see [“Translation”](#) on page 64.

## Adding Annotations

The following types of annotations can be added to iPlot displays:

| Plot Annotation Type | Description   |
|----------------------|---|
| Text                 | Single lines or multiple lines of text can be added to a visualization to provide a label or description.     |
| Line                 | Straight line annotations can be added to a visualization to link labels to objects or to identify an object. |
| Rectangle            | Rectangular annotations can be added to a visualization to identify rectangular areas.                        |
| Oval                 | Oval annotations can be added to a visualization to identify elliptical areas.                                |
| Polygon              | Polygon annotations can be added to a visualization to identify areas bounded by a multi-sided polygon.       |
| Freehand             | Freehand annotations can be added to a visualization to identify an area.                                     |

*Table 13-1: Types of Plot Annotations*

For more information on creating and using annotations, see [Chapter 5, “Adding Annotations”](#).

## View Zoom

View Zoom allows you to zoom in or out on a specific area of the plot display area. To zoom in or out in View Zoom mode click Zoom  on the toolbar. For more information on working with View Zoom, see “[Zooming](#)” on page 70.

## Canvas Zoom

Canvas Zoom allows you to increase or decrease the magnification of the entire display canvas (which may contain multiple views, depending on the layout) by a specified percentage. Canvas Zoom is available by selecting the pull-down percentage list from the top of the tool just under the Help menu. For more information on working with Canvas Zoom, see “[Zooming](#)” on page 70.

## Selecting the Data Range

In a two-dimensional plot, your data range can be manipulated in several ways. First, enter into the Data Range tool mode by clicking on the Data Range button  on the toolbar. You can then manipulate your data range in the following ways:

- Clicking and dragging a selection box within the view. The selected range becomes the new data range.
- Panning in one direction or another along a single axis by clicking on the arrow manipulators.
- Zooming in or out by clicking on one of the plus or minus symbols. When isotropic scaling is in effect (the default for the iPlot tool), these symbols appear at the axis origin, and will impact both the X and Y ranges simultaneously.

---

**Note**

Plots are clipped to fit within newly selected data ranges.

---

# iPlot Tool Operations

The iPlot tool allows you many operations for your existing plot displays. Once you have visualized your plot data, you can scale and filter as well as creating a histogram or viewing statistics for your plot. The following operations are available for plots.

## Scaling a Plot Display

iPlot allows you to scale your plotted data by selecting **Operations** → **Transform** → **Scale Data**. You can scale your data by a factor which you provide in the **Scale Factor** dialog.

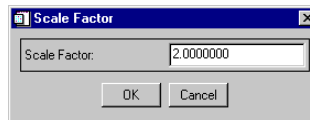

*Figure 13-13: Setting the Plot Scale Factor*

Once you have set the scale factor, select **OK** and the scaling takes place.

## Viewing a Histogram

A density histogram is a plot consisting of either horizontal or vertical bars. The widths or heights of these bars represent data values. Another type of histogram is a style plot histogram which plots different data sets side-by-side using differently styled points or bars to represent the data. To view a density histogram of plot data, use the iTool's histogram feature by selecting **Operations** → **Histogram**. For information on histogram creation, see [“Plotting a Histogram”](#) on page 126.

## Viewing Statistics

To view statistics for plot data, use the iTool's statistics feature by selecting **Operations** → **Statistics**. For information on viewing statistics, see [“Displaying Statistics”](#) on page 127.





# Chapter 14

# Working with Volumes

This chapter describes how to use the iVolume tool.

---

|                              |     |                                       |     |
|------------------------------|-----|---------------------------------------|-----|
| Introduction .....           | 302 | Resampling Volumes .....              | 312 |
| Displaying Volumes .....     | 303 | Showing an Image Plane .....          | 313 |
| Using the Volume Panel ..... | 307 | Extracting an IsoSurface .....        | 314 |
| Volume Properties .....      | 309 | Extracting an Interval Volume .....   | 316 |
| Adding a Colorbar .....      | 310 | Manipulating the Volume Display ..... | 318 |
| Adding Axes .....            | 311 | iVolume Tool Operations .....         | 320 |

# Introduction

The IDL iVolume tool displays your data in volume form. The iVolume tool then allows you great flexibility in manipulating and visualizing volume data. To use iVolume, from the IDL Command Line, type `iVolume`. An empty iVolume tool appears. You can then import volume data using any of several data import methods. For more information importing volume data see [Chapter 2, “Importing and Exporting Data”](#).

---

**Note**

For more information on accepted arguments, see “**IVOLUME**” in the *IDL Reference Guide* manual.

---

The iVolume tool can be launch in many different ways:

- At the IDL Command Line without arguments or keywords
- At the IDL Command Line with arguments or keywords
- Through the **File** → **New** → **Visualization** → **iVolume** menu option in the IDL Development Environment
- Through the **File** → **New** → **iVolume** menu option in an iTool

# Displaying Volumes

The iVolume tool's primary purpose is to visualize volume data, though the tool is capable of much more once the data is displayed. The iVolume tool also allows you to manipulate and edit the displays. The first task is to display the volume data.

Before displaying, volume data must be loaded into the tool. Here is a simple example of one way to load in some data.

At the IDL command line, enter:

```
file = FILEPATH('head.dat', $
    SUBDIRECTORY = ['examples', 'data'])
data = READ_BINARY(file, DATA_DIMS = [80, 100, 57])
IVOLUME, data
```

---

**Note**

The `examples/data` directory of your IDL 6.2 distribution contains a text file named `index.txt`. This file lists all data files available in the example directory and also lists their dimensions and values.

---

---

**Note**

IDL converts and stores volume data in a `BYTE` array. Thus, all incoming volume data is converted to `BYTE` type. This could alter the volume data values if the incoming data cannot accurately be stored as `BYTE` data.

---

## Multi-Channel Volumes

The data in the previous example is a single-channel volume which is volume data specified in a single parameter. This is the simplest and most common way to display volume data. The iVolume tool also supports two-channel and four-channel volume rendering. Two-channel rendering allows you to combine or blend two volume arrays together. Four-channel rendering is useful when your volume data is composed of a volume array for each of the red, green, blue, and alpha display channels. Note that the dimensions of all the volume arrays used in multi-channel volume rendering must be the same.

In the following example, the second volume array of a two-channel volume is used as a mask to cut out a portion of the volume to create a hole. With the `head.dat` data already loaded from the `examples/data` directory, a mask volume is created and displays the result:

```
mask = BYTARR(80, 100, 57)
```

```
mask[*] = 255
mask[30:50, *, 20:30] = 0
IVOLUME, data, mask
```

A rectangular hole through the middle of the head is created, making portions of the inside more visible.

The following is an example of a four-channel volume:

```
red = BYTARR(20,20,20)
green = BYTARR(20,20,20)
blue = BYTARR(20,20,20)
alpha = BYTARR(20,20,20)

red[10:*,*,*]=255
green[* ,10:*,*]=255
blue[* ,*,10:*=255
alpha[*] = 128
IVOLUME, red, green, blue, alpha
```

## Rendering Volumes

Volume data does not automatically appear in the tool window since volume rendering can be a time consuming operation. To render the volume, click the **Render** button on the tool. Auto render is available but not set by default since it can slow down your iTool session if you have simultaneous operations.

---

### Note

Volume data is only rendered if the volume data space is selected. Thus, if you have multiple volumes in your data space, auto render must be turned on in order to render both simultaneously.

---



The data loaded earlier can be displayed by clicking the **Render** button.

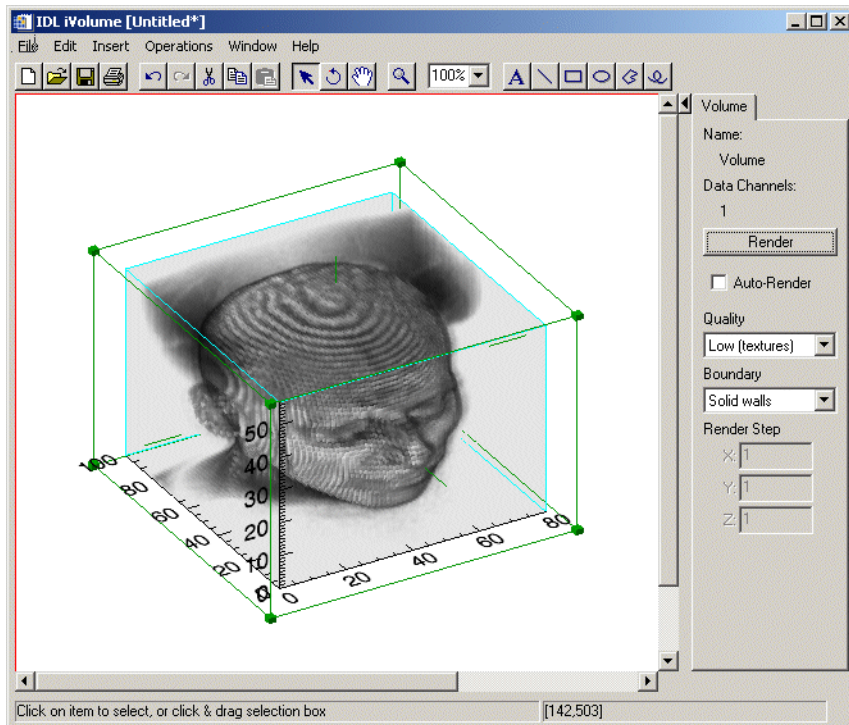

Figure 14-1: Rendered MRI Head Volume Data

## Rendering Quality

The volume can be rendered in two quality modes:

- **Low** — Done with a stack of 2D texture-mapped semi-transparent polygons. The polygons are oriented so that the flat sides face the viewer as directly as possible. On most systems, Low-quality mode renders faster than High-quality mode, but not as accurately.
- **High** — Done with the IDLgrVolume ray-casting volume renderer. This quality mode is CPU-intensive and will usually take much longer than the Low-quality mode.

## Extents

Since the volume is not always rendered, iVolume draws volume extents to help you locate and select the volume. You can select the volume by selecting on the extents, without rendering the volume. By default, iVolume draws a translucent solid cube with internal extents. You can also select a wire frame, or no extents within the visualization browser.

---

**Note**

Use caution when turning off extents. If extents are turned off and auto render is also off, you may need to use the Visualization Browser to select the volume again.

---

## Using the Volume Panel

The volume panel appears to the right of the visualization window of the iVolume tool. This panel allows you to render and manipulate rendering properties. The components and functions of the volume panel are discussed in the following figure and list.

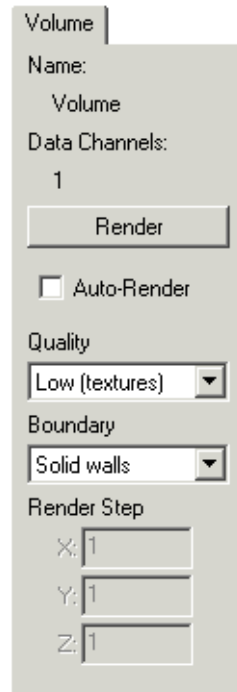

Figure 14-2: The Volume Panel

- **Name** — The volume object's name (if any).
- **Data Channels** — The volume's data channels.
- **Render** — This button will render the volume data.
- **Auto-Render** — Select this checkbox to enable auto-rendering.
- **Quality** — Pull-down menu to select desired volume rendering quality. Select Low (textures) or High (volume).

- **Boundary** — Pull-down menu to select desired volume data space boundaries. Select none, wire frame, or solid walls.
- **Render Step** — Enter desired order for rendering here (if any).

# Volume Properties

The iVolume window is a self-contained volume display and manipulation device. You can import and export volume data, and modify and manipulate volume data. For more information on the basic iVolume interface and its layout, see [Appendix A, “iTools Interface Reference”](#).

## Modifying Properties

By selecting **Edit** → **Properties** from the iVolume tool, you can modify your volume properties. You may modify your volume’s name, description as well as the show/hide properties and the line color, style, and thickness. For more information on editing properties in the iTools, see [Appendix D, “Visualization Properties”](#).

# Adding a Colorbar

You can add a colorbar to your visualized volume which will show on a color scale the minimum to maximum values of data in the visualization. To add a colorbar, click on the volume visualization and then from the iVolume window, select **Insert** → **Colorbar**. A colorbar will be placed in the visualization window. This colorbar can be resized and moved around the data space. You can also double-click on the colorbar to invoke the Visualization Browser which will allow you to change the properties for the colorbar.

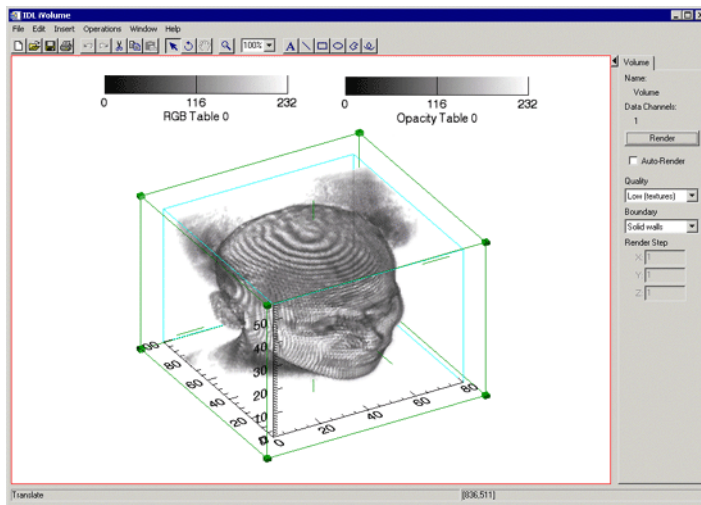

Figure 14-3: Rendered Volume with Colorbar Added

# Adding Axes

By default, volumes are displayed with X, Y, and Z axes. The display of these axes is controlled by property sheets for the axes container and for individual axes (see [“Axes”](#) on page 458). Additional X, Y, or Z axes can be added to a volume visualization to make it easier to identify volume characteristics.

To add an axis to your volume visualization:

1. Select the volume.
2. Select **Insert** → **Axis**.
3. Choose from the following options:
  - **X axis**
  - **Y axis**
  - **Z axis**

Use the mouse to position the new axis and double-click the axis to display the axis property sheet.

For more information on adding axes, see [“Additional Axes”](#) on page 84.

# Resampling Volumes

Resampling re-imports the selected volume data using parameters specified in the Resample properties. Resampling parameters include factors for adjusting the X, Y, or Z dimensions of the data, as well as the interpolation method to be used.

To resample volume data:

1. Select one or more volumes in the iVolume window for resampling.
2. If necessary, use the Operations Browser to set the desired parameters through the Resample properties. See “[Resample Properties](#)” on page 388 for details.
3. Select **Operation** → **Transform** → **Resample**.

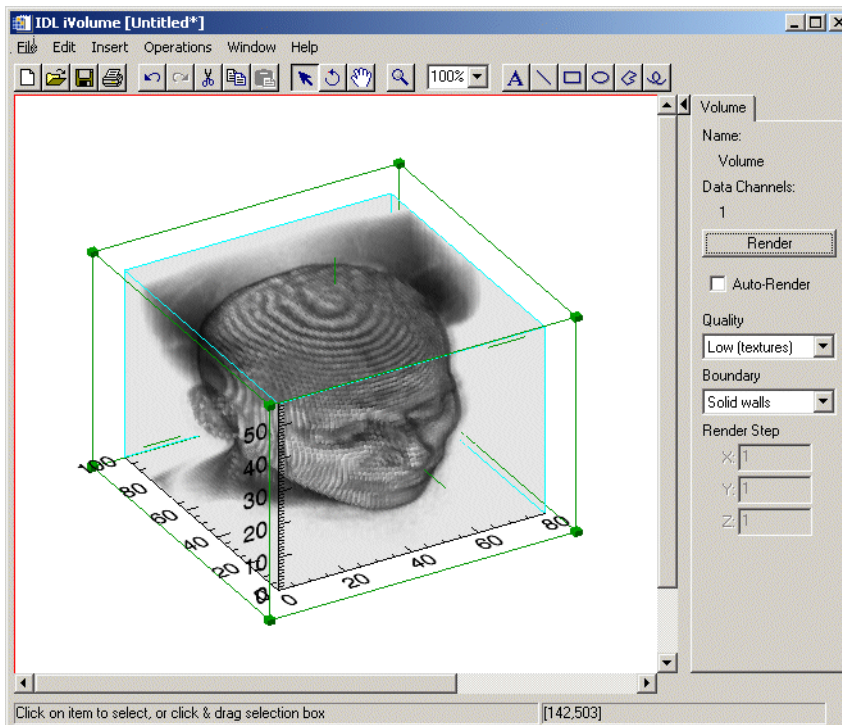

Figure 14-4: Resampled and Rendered Volume



## Showing an Image Plane

An image plane is a visualization of a slice of the volume. An image plane can be dragged and rotated within the volume. To show an image plane for a portion of volume data, first be sure your volume is selected and then choose **Operations** → **Volume** → **Image Plane**. An image plane appears showing a cross-section of your volume data. You can change the orientation of an image plane by double-clicking on the image plane to bring up the property browser. You can also click on the edge of the plane and move it to various other points in the volume data.

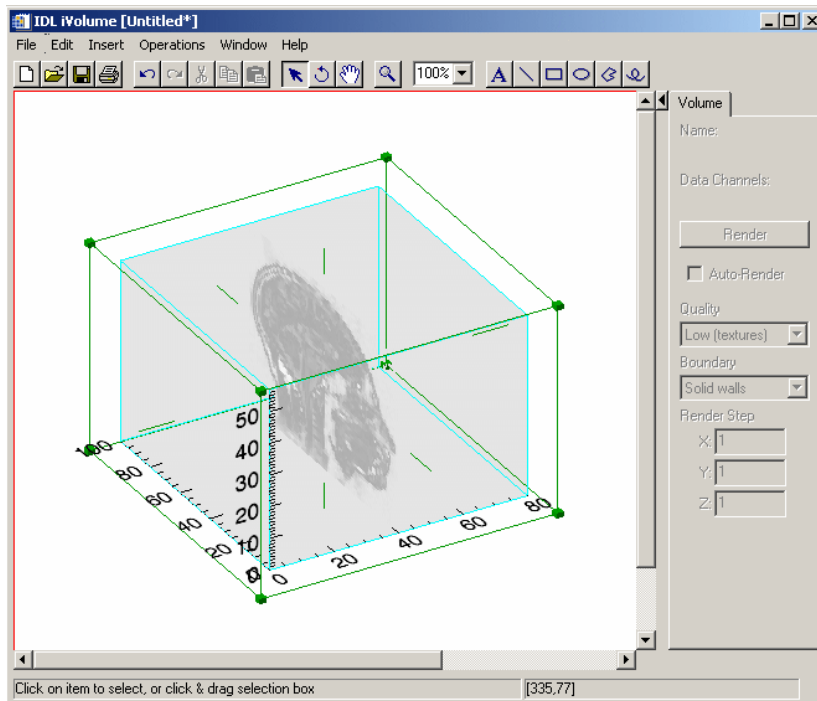

Figure 14-5: Image Plane of a Rendered Volume

## Viewing the Image Plane in iImage

Image plane data is available in Data Manager and can be utilized in the iImage tool for closer image analysis. The image plane image data is always a four-channel RGBA truecolor image. To view your image plane in iImage, from the iVolume tool select **Operations** → **Image Plane** → **Launch iImage**.

# Extracting an IsoSurface

An isosurface is a set of polygons drawn in the volume to represent a surface that has a specific constant value (the isovalue). An isosurface cannot be translated, scaled, or rotated relative to the volume but does move with the volume.

To create an isosurface, select **Operations** → **Volume** → **IsoSurface** and iVolume displays a dialog allowing you to specify the isovalue. If the volume is multi channel, you can select a channel and set its isovalue.

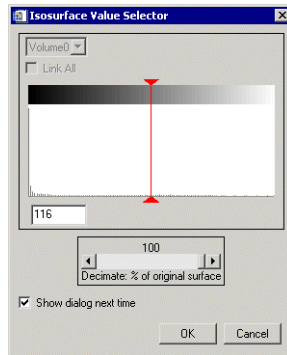

Figure 14-6: Isosurface Value Selector for iVolume

You will then create an isosurface for that channel by selecting **OK**.

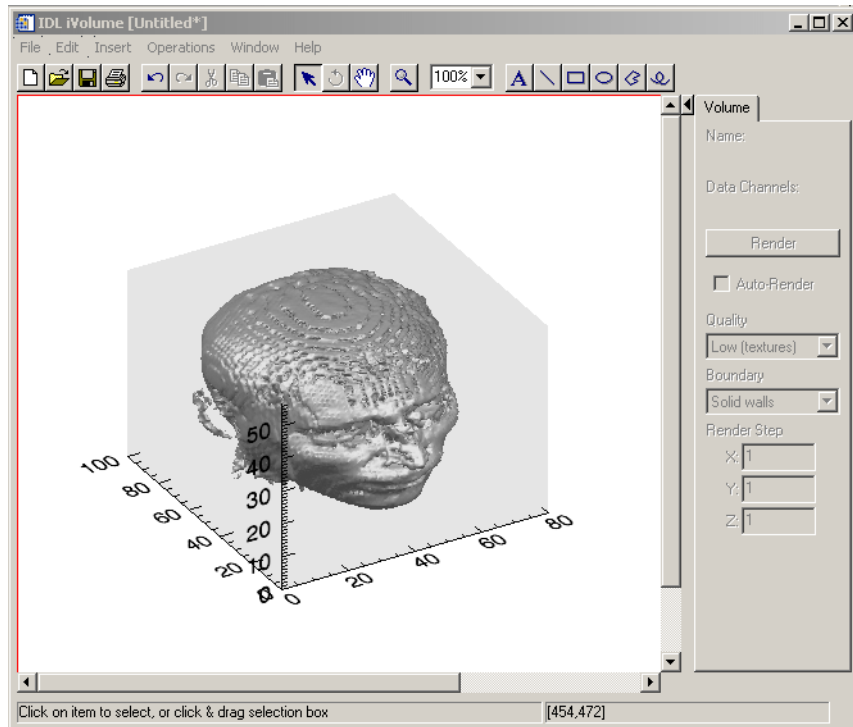

Figure 14-7: Isosurfaced Rendered Volume

### Note

Isosurfaces often contain a large number of polygons, which may degrade iVolume's display performance. When selecting the isovalue, you can also specify a decimation percentage to reduce the number of polygons in the resulting isosurface. This decimation step requires additional time, but the resulting isosurface will contain fewer triangles and will draw faster.

Consider adding a light to improve the isosurface display. Select **Insert** → **Light** to add a light.

# Extracting an Interval Volume

An interval volume is a set of tetrahedra that span a space between two isovalues within a volume. Since a tetrahedral mesh is a solid, iVolume displays the outer surface of the mesh as a set of polygons. This surface cannot be translated, scaled, or rotated relative to the volume but does move with the volume.

To create an interval volume, select **Operations** → **Volume** → **Interval Volume**, and a dialog appears allowing you to set two isovalues.

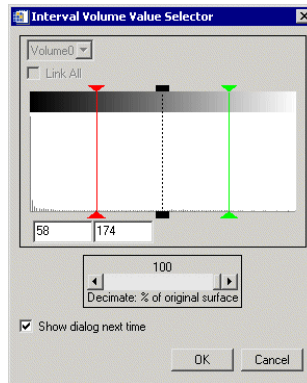

Figure 14-8: Interval Volume Value Selector for iVolume

If the volume is multi channel, you can select a channel for setting the isovalues and then create an interval volume for that channel by selecting **OK**.

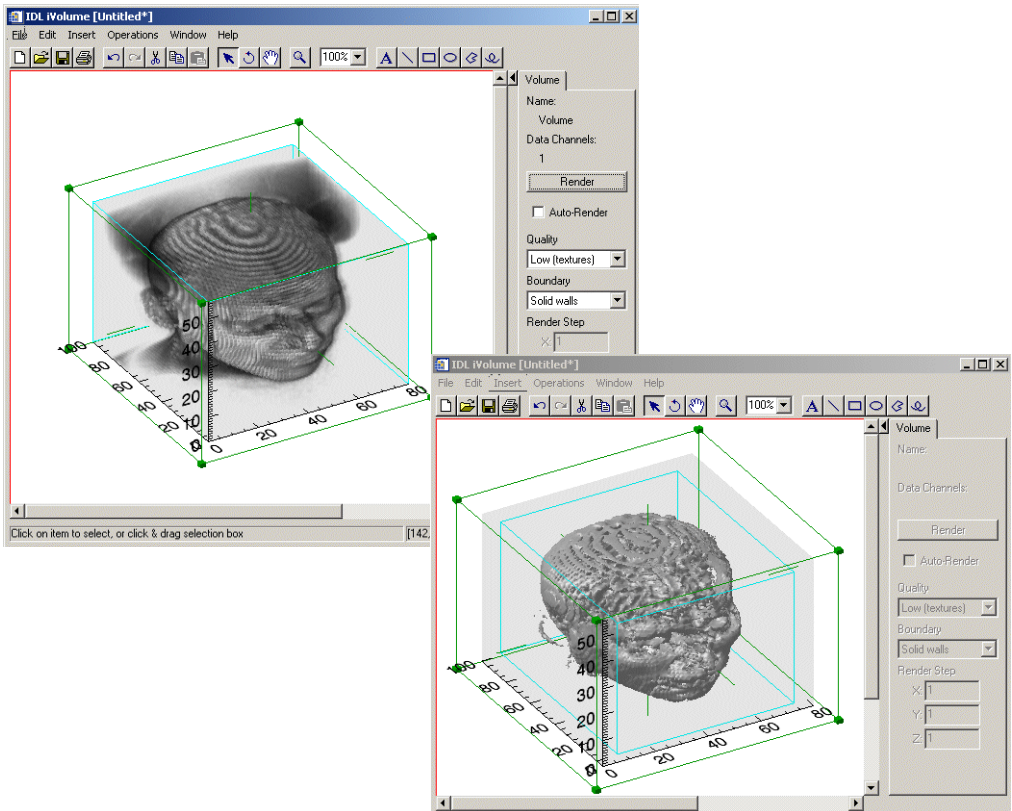

Figure 14-9: Original Volume Visualization and Interval Volume

---

### Note

Vertex colors are not persevered during decimation.

---

### Note

Interval volume surfaces often contain a large number of polygons, which can degrade iVolume's display performance. When selecting isovalues, you can specify a decimation percentage to reduce the number of polygons in the resulting surface. This decimation step requires additional time, but the resulting surface will contain fewer triangles and will draw faster.

---

# Manipulating the Volume Display

The iVolume tool allows you many options to manipulate your existing volume displays. Once you have visualized your volume data, you may rotate, translate, scroll, and zoom as well as modify volume properties. The following options are available for manipulating volumes.

## Rotating a Volume

Rotating makes it possible to rotate the volume within the visualization without affecting the rest of the data space (graphical objects and axes). To rotate your volume, from the toolbar on the iVolume window, select the **Rotate** button. For more information about rotating, see “[Rotation](#)” on page 113.

## Scaling a Volume

It is possible to scale the data within a volume by a specified scale factor. To scale your volume, select **Operations** → **Transform** → **Scale Data**. For more information on scaling data, see “[Scaling](#)” on page 65.

## View Zoom

View Zoom allows you to zoom in or out on a specific area of the volume display area. To zoom in or out in View Zoom mode click **Zoom**  on the toolbar. For more information on working with View Zoom, see “[Zooming](#)” on page 70.

## Canvas Zoom

Canvas Zoom allows you to increase or decrease the magnification of the entire display canvas (which may contain multiple views, depending on the layout) by a specified percentage. Canvas Zoom is available by selecting the pull-down percentage list from the top of the tool just under the Help menu. For more information on working with Canvas Zoom, see “[Zooming](#)” on page 70.

## Adding Annotations

Annotations can be added to label or describe volume visualizations displayed in the iVolume tool.

The following types of annotations can be added to iVolume displays:

| <b>Plot Annotation Type</b> | <b>Description</b>  |
|-----------------------------|---|
| Text                        | Single lines or multiple lines of text can be added to a visualization to provide a label or description.     |
| Line                        | Straight line annotations can be added to a visualization to link labels to objects or to identify an object. |
| Rectangle                   | Rectangular annotations can be added to a visualization to identify rectangular areas.                        |
| Oval                        | Oval annotations can be added to a visualization to identify circular areas.                                  |
| Polygon                     | Polygon annotations can be added to a visualization to identify areas bounded by a multi-sided polygon.       |
| Freehand                    | Freehand annotations can be added to a visualization to identify an area.                                     |

*Table 14-1: Types of Volume Annotations*

For more information on creating and using annotations, see [Chapter 5, “Adding Annotations”](#).

# iVolume Tool Operations

The iVolume tool allows you operations for your existing volume displays. Once you have visualized your volume data, you can scale and filter as well as creating a histogram or viewing statistics for your volume. The following operations are available for volumes.

## Viewing a Histogram

A density histogram is a plot consisting of either horizontal or vertical bars. The widths or heights of these bars represent data values. Another type of histogram is a style plot histogram which plots different data sets side-by-side using differently styled points or bars to represent the data. To view a density histogram of volume data, use the iTool's histogram feature by selecting **Operations** → **Histogram**. For information on histogram creation, see [“Plotting a Histogram”](#) on page 126.

## Viewing Statistics

To view statistics for volume data, use the iTool's statistics feature by selecting **Operations** → **Statistics**. For information on viewing statistics, see [“Displaying Statistics”](#) on page 127.

## Smoothing a Volume

Within the iVolume tool, plots can also be smoothed to soften edges or compensate for random noise in the volume.

To apply the smooth filter to a volume:

1. Select the volume.
2. Select **Operations** → **Filter** → **Smooth**.

## Opening an Image Stack

iVolume allows you to open a group of images as an image stack within the tool. To open images as an image stack select **File** → **Open Image Stack...** From the dialog, select the images you wish to open using either **Shift** + right click if images are consecutive or **Ctrl** + right click if nonconsecutive.



**Note**

---

Images are opened and stacked in the order they are named and not in the order of selection. In other words file names are opened alphanumerically. The only way to control the order of opening files is through the naming or renaming of files.

---





# Chapter 15

# Working with Maps

This chapter describes how to use the map iTool.

---

|   |     |  |     |
|---|-----|--|-----|
| <a href="#">Introduction</a> .....              | 324 | <a href="#">Registering an Image</a> .....           | 333 |
| <a href="#">Displaying Maps</a> .....           | 325 | <a href="#">Displaying a Contour</a> .....           | 340 |
| <a href="#">Applying a Map Projection</a> ..... | 326 | <a href="#">Creating a Shape Visualization</a> ..... | 341 |
| <a href="#">Using the Map Panel</a> .....       | 330 | <a href="#">Inserting a Map Grid</a> .....           | 342 |
| <a href="#">Displaying an Image</a> .....       | 332 | <a href="#">Inserting an IDL Shapefile</a> .....     | 343 |

# Introduction

The IDL iMap tool displays image and contour data that are georeferenced and mapped to particular projections, as well as shapefile data. The iMap tool gives you great flexibility in manipulating and visualizing these data. To use iMap, from the IDL Command Line, type `iMap`. An empty iMap tool appears. You can then import image or contour data using any of several data import methods. For more information on importing data, see [Chapter 2, “Importing and Exporting Data”](#).

---

**Note**

For more information on accepted arguments and keywords, see “[IMAP](#)” in the *IDL Reference Guide* manual.

---

The iMap tool can be launched in many different ways:

- At the IDL Command Line without arguments or keywords
- At the IDL Command Line with arguments or keywords
- Through the **File** → **New** → **Visualization** → **iMap** menu option in the IDL Development Environment
- Through the **File** → **New** → **iMap** menu option in an iTool
- On Windows platforms, from the **Start** menu (**Start** → **Programs** → **RSI IDL 6.1** → **iTools** → **iMap**)

# Displaying Maps

The iMap tool's primary goal is to visualize map data, though the tool is capable of much more once the data is displayed. The iMap tool also allows you to manipulate and edit the displays. The first task is to display the map data.

Your options for calling the iMap tool are:

- At the IDL Command Line without arguments or keywords
- At the IDL Command Line with arguments or keywords

---

**Note**

Arguments and keywords are accepted at the IDL Command Line for the iMap tool, for more information on accepted arguments and keywords, see [“IMAP”](#) in the *IDL Reference Guide* manual.

---

- Through the **File** → **New** → **Visualization** → **iMap** menu option in the IDL Development Environment
- Through the **File** → **New** → **iMap** menu option in an iTool
- On Windows platforms, from the **Start** menu (**Start** → **Programs** → **RSI IDL 6.1** → **iTools** → **iMap**)

You have two options for getting started with displaying a map. You can:

- Apply a map projection and then visualize data within it
- Visualize image or contour data and then apply a map projection to it

To get started with one of these options, see the following sections:

- [“Applying a Map Projection”](#) on page 326
- [“Displaying an Image”](#) on page 332
- [“Displaying a Contour”](#) on page 340

# Applying a Map Projection

A *map projection* establishes the axis type and coordinate conversion mechanism for mapping points on the earth's surface, expressed in latitude and longitude, to points on a plane, according to one of several possible map projections.

You can apply a map projection before or after you import image or contour data into the iMap tool. To do so, select **Operations** → **Map Projection**. This command opens the Map Projection dialog, shown in [Figure 15-1](#).

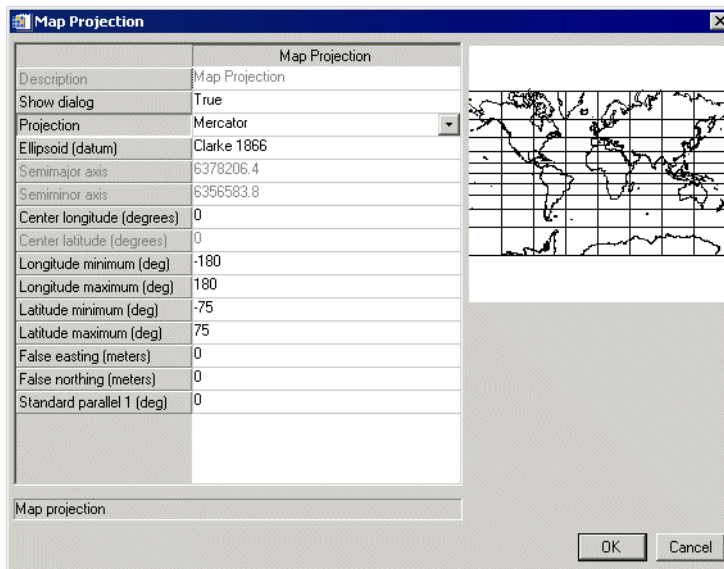

Figure 15-1: The Map Projection Dialog

You can apply a map projection to another iTool as well. If you do, the tool will adapt to expose iMap functionality, including the iMap operations and the Map panel.

[Table 15-1](#) shows the common projection properties.

| Name        | Description                       |
|-------------|-----------------------------------|
| Description | Description of the map projection |

Table 15-1: Common Map Projection Properties

| Name                       | Description  |
|----------------------------|--|
| Show dialog                | Show this dialog before executing the Map Projection operation       |
| Projection                 | Name of the map projection   |
| Ellipsoid (datum)          | Semimajor and -minor axes that define the ellipsoid                  |
| Semimajor axis             | Length of the semimajor axis, in meters, for the reference ellipsoid |
| Semiminor axis             | Length of the semiminor axis, in meters, for the reference ellipsoid |
| Center longitude (degrees) | Longitude in degrees of the projection's center                      |
| Center latitude (degrees)  | Latitude in degrees of the projection's center                       |
| Longitude minimum (deg)    | Minimum longitude to include in the projection, in degrees           |
| Longitude maximum (deg)    | Maximum longitude to include in the projection, in degrees           |
| Latitude minimum (deg)     | Minimum latitude to include in the projection, in degrees            |
| Latitude maximum (deg)     | Maximum latitude to include in the projection, in degrees            |
| False easting (meters)     | False easting to be added to each $x$ -coordinate, in meters         |
| False northing (meters)    | False northing to be added to each $y$ -coordinate, in meters        |

*Table 15-1: Common Map Projection Properties (Continued)*

In addition to these properties, the following properties ([Table 15-2](#)) become available depending on the selected projection:

| Name                    | Description  |
|-------------------------|--|
| Height (meters)         | Height above surface, in meters, for satellite projections       |
| Hemisphere              | Hemisphere for UTM and Polar projections                         |
| HOM azimuth angle (deg) | Hotine Oblique Mercator azimuth angle (degrees) east             |
| HOM latitude 1 (deg)    | Hotine Oblique Mercator latitude, in degrees, of the first point |

*Table 15-2: Properties for Selected Map Projections*

| Name                     | Description  |
|--------------------------|--|
| HOM latitude 2 (deg)     | Hotine Oblique Mercator latitude, in degrees, of the second point  |
| HOM longitude 1 (deg)    | Hotine Oblique Mercator longitude, in degrees, of the first point  |
| HOM longitude 2 (deg)    | Hotine Oblique Mercator longitude, in degrees, of the second point   |
| IS longitudinal zones    | Integerized Sinusoidal number of longitudinal zones  |
| IS row justify flag      | Integerized Sinusoidal flag that indicates what to do with rows with an odd number of columns. The following values are allowed: <ul style="list-style-type: none"> <li>• 0 — Indicates the extra column is on the right of the projection y-axis</li> <li>• 1 — Indicates the extra column is on the left of the projection y-axis</li> <li>• 2 — Calculates an even number of columns</li> </ul> |
| Mercator scale           | Scale factor at the central meridian (for the Transverse Mercator projection) or the center of the projection (for the Hotine Oblique Mercator projection)   |
| NAD27 Zone name (FIPS)   | NAD27 State Plane Coordinate System Zone (FIPSZone)  |
| NAD83 Zone name (FIPS)   | NAD83 State Plane Coordinate System Zone (FIPSZone)  |
| OEA horizontal shape m   | Oblated equal area horizontal ( <i>m</i> ) shape parameter   |
| OEA vertical shape n     | Oblated equal area vertical ( <i>n</i> ) shape parameter   |
| OEA rotation angle (deg) | Oblated equal area rotation angle, in degrees  |
| SOM end-of-path flag     | Space Oblique Mercator Landsat end-of-path flag, where 0 is the start and 1 is the end   |
| SOM inclination (deg)    | Space Oblique Mercator orbit inclination angle, in degrees, of the ascending node, counter-clockwise from the equator  |
| SOM Landsat number       | Space Oblique Mercator Landsat number (Worldwide Reference System)   |

Table 15-2: Properties for Selected Map Projections (Continued)



| Name                      | Description  |
|---------------------------|--|
| SOM Landsat path          | Space Oblique Mercator Landsat path number   |
| SOM longitude (deg)       | Space Oblique Mercator longitude, in degrees, of the ascending node  |
| SOM period (minutes)      | Space Oblique Mercator satellite period, in minutes  |
| SOM ratio                 | Space Oblique Mercator Landsat ratio that compensates for confusion at the northern end of orbit             |
| Standard parallel 1 (deg) | First standard parallel (degrees latitude) of true scale   |
| Standard parallel 2 (deg) | Second standard parallel (degrees latitude) of true scale  |
| Zone (1-60)               | Universal Transverse Mercator (UTM) grid zone number (must be negative for zones in the southern hemisphere) |

*Table 15-2: Properties for Selected Map Projections (Continued)*

---

**Note**

The map projection properties are normally taken from the currently selected dataspace. However, in the Operations Browser, the map projection properties are registered on the operation itself. Changing these properties in the Operations Browser will have no effect on the currently selected dataspace. If the Show Dialog property is set to False and then the Map Projection operation is activated, the projection properties will be copied directly from the Map Projection operation onto the currently selected dataspace.

---



---

**Note**

Each projection has default longitude and latitude limits. If you have not modified one of these limits (the longitude and latitude minimum and maximum properties), the Map Projection operation will automatically use its default limit. However, if you have modified one of these limits, the Map Projection operation will use either your desired limit or the default limit, whichever is smaller.

---

# Using the Map Panel

The iMap tool has a Map panel (Figure 15-2) that lets you manipulate the map display. The panel also appears when you apply a map projection or shapefile into another iTool.

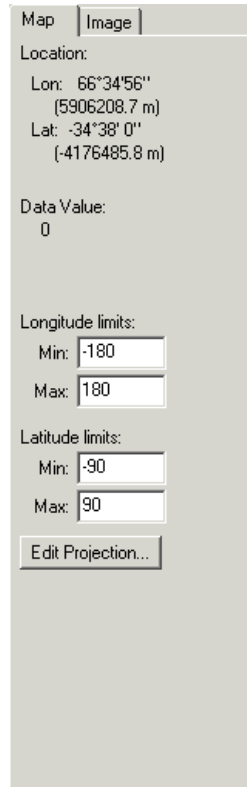

Figure 15-2: The Map Panel in the iMap Tool

Table 15-3 describes the items on the Map panel.

| Name               | Description   |
|--------------------|---|
| Location           | <p>Displays the following information:</p> <ul style="list-style-type: none"> <li>• If no map projection is applied — the cursor location in degrees longitude/latitude or meters, depending on the image units</li> <li>• If a map projection is applied — the cursor location in degrees longitude/latitude and the corresponding Cartesian <math>XY</math> (or <math>UV</math>) coordinates in meters</li> </ul> <p>Sensitive only if an image or a contour is selected.</p> |
| Data Value         | <p>Displays the following information:</p> <ul style="list-style-type: none"> <li>• For an image — the data value and corresponding grayscale or RGB value for the current cursor location (identical to Pixel Value on the Image panel)</li> <li>• For a contour — the data value for the current cursor location</li> </ul> <p>Sensitive only if an image or contour visualization is selected.</p>   |
| Longitude limits   | <p>Displays the active map projection’s maximum and minimum longitude values. Enter new values to update these limits.</p> <p>Sensitive only if a dataspace (or a visualization within the dataspace) with a map projection is selected.</p>  |
| Latitude limits    | <p>Displays the active map projection’s maximum and minimum latitude values. Enter new values to update these limits.</p> <p>Sensitive only if a dataspace (or a visualization within the dataspace) with a map projection is selected.</p>   |
| Edit Projection... | <p>Opens the Map Projection dialog for the currently active dataspace. For more information, see <a href="#">“Applying a Map Projection”</a> on page 326.</p>   |

Table 15-3: Items on the Map Panel

# Displaying an Image

You can visualize image data in the iMap tool as you would in the iImage tool. To learn more about visualizing image data, see [“Displaying Images”](#) on page 207.

---

**Note**

By default, the iMap tool creates an image visualization if given a 2D array or a Truecolor image. This image is warped internally to fit the map projection, if one is present. The actual image data itself remains unchanged.

---

When you open an image in the iMap tool, you need to *register* the image to define how the pixel data corresponds to points on the earth’s surface. For more information on this process, see [“Registering an Image”](#) on page 333.

Once you have image data in the iMap tool, all of the features of the iImage tool are available. For more information, see [Chapter 10, “Working with Images”](#).

You can export the mapped image by selecting **File** → **Export**. When the IDL Data Export wizard opens, choose the "To a file" option, the image visualization to save, and the output file format. The result will be the image warped to the current map projection.

---

**Note**

Depending on the map projection, the alpha channel might be used to mask out pixels outside the map boundary. In this case, you can export the image to a file format that supports four channels, such as TIFF, PNG, or JPEG2000.

---

# Registering an Image

The Map Register Image wizard, shown in [Figure 15-3](#), registers an image's data, creating a correspondence between the image pixels and points on the earth's surface. This registration step is necessary to let the iMap tool properly display the image data in the map projection you select.

The wizard launches automatically when you import image data or open an image file for which not all necessary map information is known. To launch the wizard after the image is open and registered (e.g., if you want to change the registering properties), select **Operations** → **Map Register Image**.



Figure 15-3: The Map Register Image Wizard — Step 1

The coordinates are in either meters or degrees; which units you choose for the translation can affect how the image appears in a map projection. Selecting meters means that the image data have already been warped to a particular projection, and you need to tell IDL which projection to use in displaying the image. Selecting

degrees, on the other hand, means that the image data are not already warped, so you do not need to specify a map projection for the image. It is important that you know in which units your data are, to make the correct decision when registering the image for display.

The Map Register Image wizard reflects this difference between the units by having three steps for meters and two for degrees:

1. Select the coordinate units.
2. Set the pixel minimum, maximum, and size values.
3. (Meters only) Specify the map projection to associate with the image and, if desired, with the dataspace as well.

Once you have set these registering properties and map projection (if applicable), IDL registers the image data, and the iMap tool displays the image and the Image panel along with the Map panel.

---

**Note**

If the image being registered was originally from either a TIFF file containing GeoTIFF tags or a JPEG2000 file containing a GeoTIFF UUID box, an additional button, **Show GeoTIFF tags**, is available on the latter dialogs of the Map Register Image wizard (Steps 2 and 3 for meters, Step 2 for degrees). Pressing this button brings up a separate text window containing the GeoTIFF tags, which can be useful in determining the map registration properties.

For a list of GeoTIFF tags, see the **GEOTIFF** keyword in “**READ\_TIFF**” in the *IDL Reference Guide* manual. For more information on JPEG2000 with GeoTIFF, see <http://www.remotesensing.org/jpeg2000/>.

---

The rest of this section describes the two registration pathways, with meters or with degrees, in more detail.

## Registering an Image in Meters

If you select Meters as the coordinate units in Step 1 and click on Next, you see the wizard's Step 2 dialog for meters, shown in [Figure 15-4](#).

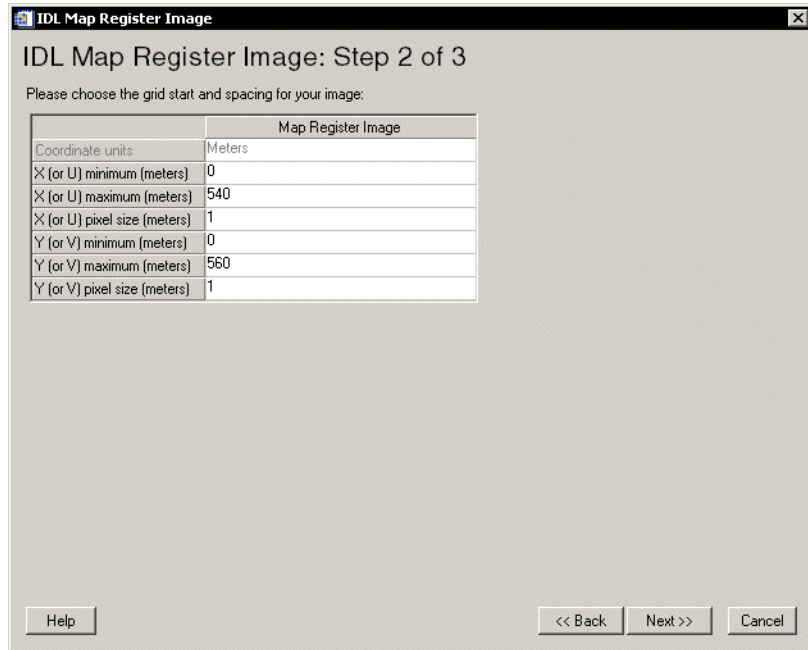

Figure 15-4: The Map Register Image Wizard — Step 2 (Meters)

[Table 15-4](#) shows the properties associated with meter coordinates.

| Name                      | Description   |
|---------------------------|---|
| X (or U) minimum (meters) | Minimum position in the $x$ (or $u$ ) direction, in meters, of the image data |
| X (or U) maximum (meters) | Maximum position in the $x$ (or $u$ ) direction, in meters, of the image data |

Table 15-4: Meter Coordinate Properties

| Name                         | Description   |
|------------------------------|---|
| X (or U) pixel size (meters) | Pixel size, in meters, in the $x$ (or $u$ ) direction                         |
| Y (or V) minimum (meters)    | Minimum position in the $y$ (or $v$ ) direction, in meters, of the image data |
| Y (or V) maximum (meters)    | Maximum position in the $y$ (or $v$ ) direction, in meters, of the image data |
| Y (or V) pixel size (meters) | Pixel size, in meters, in the $y$ (or $v$ ) direction                         |

*Table 15-4: Meter Coordinate Properties (Continued)*

**Note**

---

The  $(u,v)$  coordinates refer to the  $UV$  plane of a cylindrical projection.

---

Entering the minimum value and the pixel size automatically updates the maximum value.



Figure 15-5 shows the final step in the Map Register Image wizard for the Meters option.

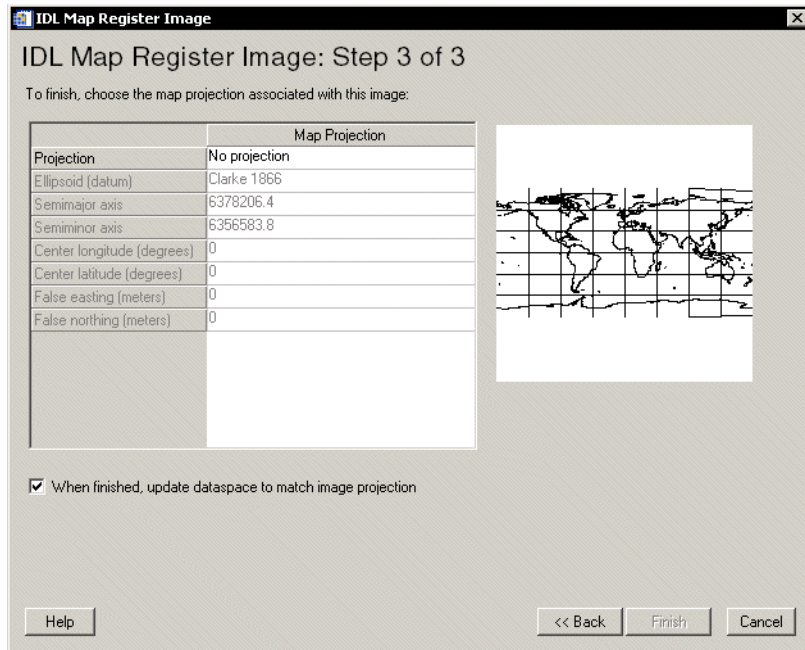
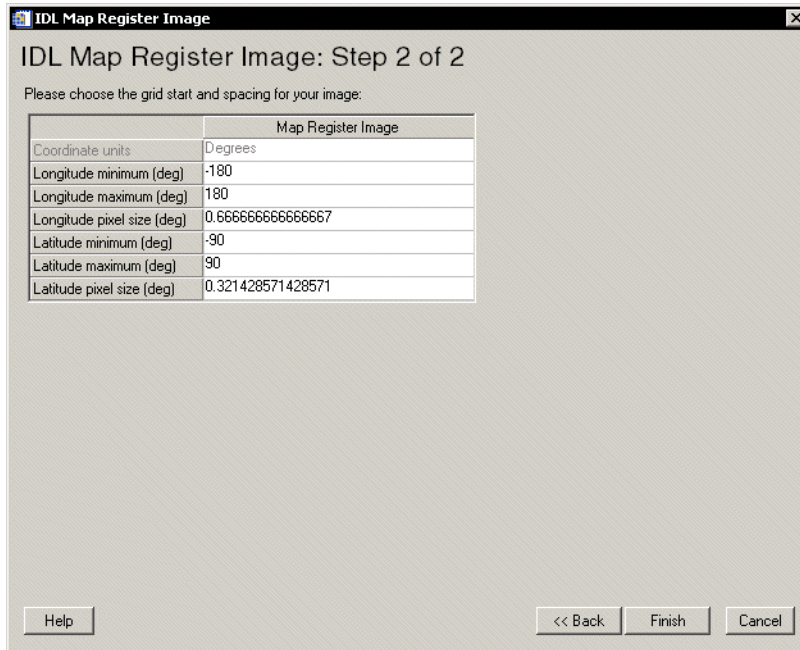

Figure 15-5: The Map Register Image Wizard: Step 3 (Meters)

In this step, you can select a map projection to associate with the image. You also have the option of updating the dataspace map projection to use this projection.

## Registering an Image in Degrees

If you select Degrees as the coordinate units in Step 1 and click on Next, you see the wizard's Step 2 dialog for degrees, shown in [Figure 15-6](#).



*Figure 15-6: The Map Register Image Wizard: Step 2 (Degrees)*

[Table 15-5](#) shows the properties associated with degree coordinates.

| Name                    | Description   |
|-------------------------|---|
| Longitude minimum (deg) | Minimum longitude position, in degrees, of the image data |
| Longitude maximum (deg) | Maximum longitude position, in degrees, of the image data |

*Table 15-5: Degree Coordinate Properties*

| Name                       | Description  |
|----------------------------|--|
| Longitude pixel size (deg) | Pixel size, in degrees, in the longitude direction       |
| Latitude minimum (deg)     | Minimum latitude position, in degrees, of the image data |
| Latitude maximum (deg)     | Maximum latitude position, in degrees, of the image data |
| Latitude pixel size (deg)  | Pixel size, in degrees, in the latitude direction        |

*Table 15-5: Degree Coordinate Properties (Continued)*

Entering the minimum value and the pixel size automatically updates the maximum value.

# Displaying a Contour

You can visualize contour data in the iMap tool as you would in the iContour tool. To learn more about visualizing contour data, see [“Displaying Contours”](#) on page 255.

Once you have contour data in the iMap tool, all of the features of the iContour tool are available. For more information, see [Chapter 12, “Working with Contours”](#).

# Creating a Shape Visualization

A *shapefile* stores nontopological geometry and attribute information for the spatial features in a data set. The shapefile format was created by ESRI, and is widely used in the geographic information systems community. The iTools display a shapefile's data by creating one of three special visualization types: ShapePolygon, ShapePolyline, and ShapePoint. The type of visualization created depends on the type of data in the shapefile.

---

**Note**

For more information on the shape visualizations, see [“Visualization Type Properties”](#) on page 417.

---

You can create a shape visualization in one of the following ways:

- Using **File** → **Open** and selecting the shapefile
- Using **File** → **Import** to launch the Data Import Wizard, and selecting the shapefile
- Using **Insert** → **Visualization** and either selecting the appropriate shape visualization type (if you have already imported the shape data into an iTool) or selecting the shapefile whose data you want to import for a shape visualization

---

**Note**

When creating a shape visualization using **File** → **Import** or **Insert** → **Visualization**, if the shapefile contains more than one item (polygon, polyline, or point), you can choose to create a single visualization containing *all* of the included items, or to create an individual visualization for each item in the file.

---

# Inserting a Map Grid

The **Insert** → **Map** → **Grid** operation creates a longitude-latitude grid (Figure 15-7) within the current dataspace, using the current projection. If no projection is active, then IDL uses geographic coordinates.

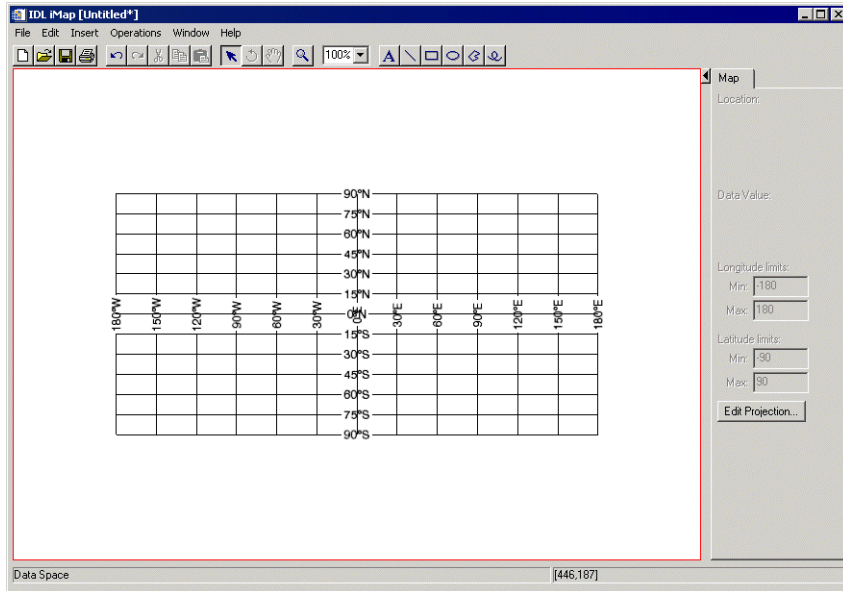

Figure 15-7: The Map Grid

The gridlines appear as a single MapGrid object within the current dataspace. For information on this visualization, see “[Map Grid](#)” on page 472.

## Note

When you insert a map grid, the Axes container within the dataspace is automatically hidden. To display the axes, use the Visualization Browser to change the Show property of the Axes container.

# Inserting an IDL Shapefile

IDL comes with several shapefiles that you can insert in the iMap tool or in another iTool that has a map projection already applied. These files originated from the ESRI Data and Maps CD-ROM data set (1999, 2000, 2002) and can be found, along with their associated database (.dbx) and index (.shx) files, in the `resource/maps/shape` directory of the IDL installation. Also see “[Overview of ESRI Shapefiles](#)” in Chapter 6 of the *IDL Reference Guide* manual for more detailed information on shapefiles.

## Inserting the Continents

The **Insert** → **Map** → **Continents** operation loads the `continents.shp` file and displays the continents as a single ShapePolygon ([Figure 15-8](#)) in the current dataspace, using the current projection. If no projection is active, then IDL uses geographic coordinates.

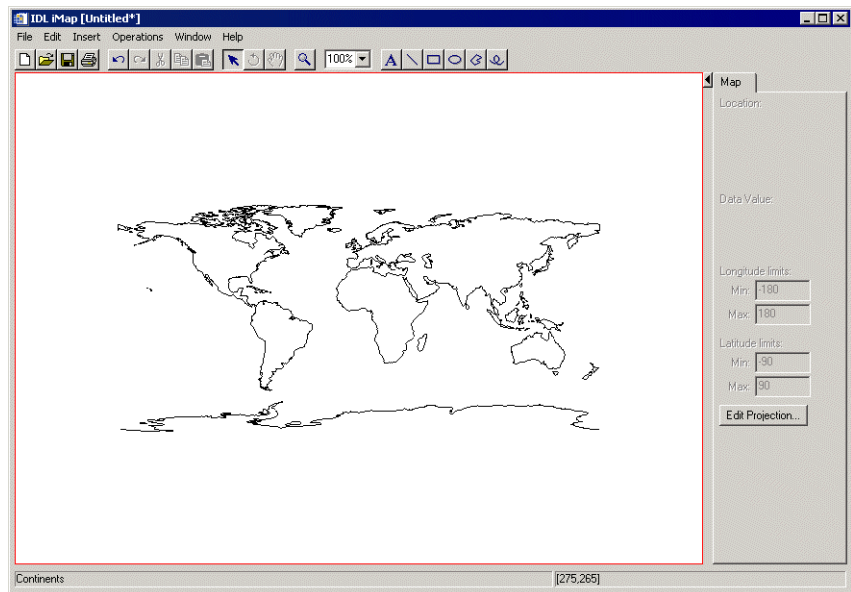

Figure 15-8: The Continents Shapefile

## Inserting the Countries (Low Resolution)

The **Insert** → **Map** → **Countries (low res)** operation loads the `country.shp` file and displays the countries (boundaries as of 2002) as separate ShapePolygons (Figure 15-9) in the current dataspace, using the current projection. If no projection is active, then IDL uses geographic coordinates. The ShapePolygons exist in a Countries (low res) visualization container.

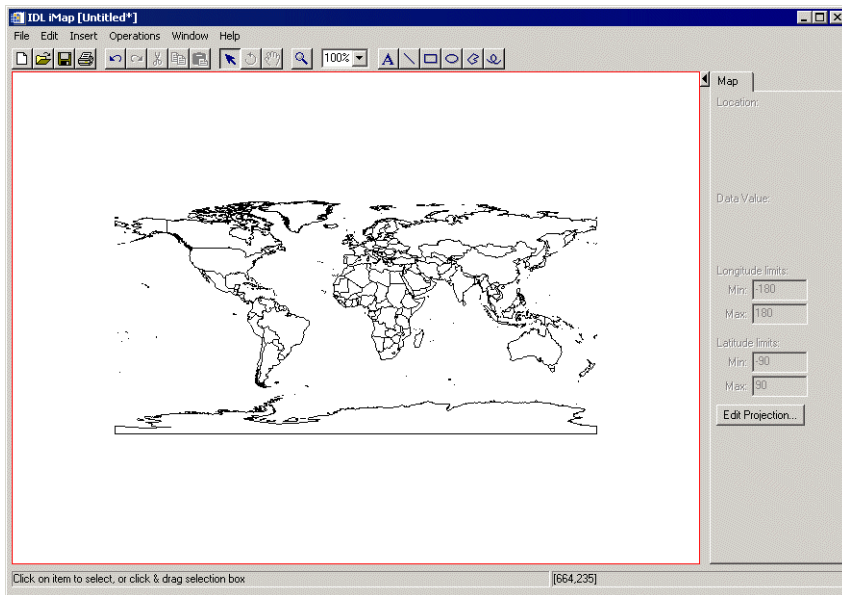

Figure 15-9: The Countries (Low Res) Shapefile

## Inserting the Countries (High Resolution)

The **Insert** → **Map** → **Countries (high res)** operation loads the `cntry02.shp` file and displays the countries (boundaries as of 2002) as separate ShapePolygons (Figure 15-10) in the current dataspace, using the current projection. If no projection is



active, then IDL uses geographic coordinates. The ShapePolygons exist in a Countries (high res) visualization container.

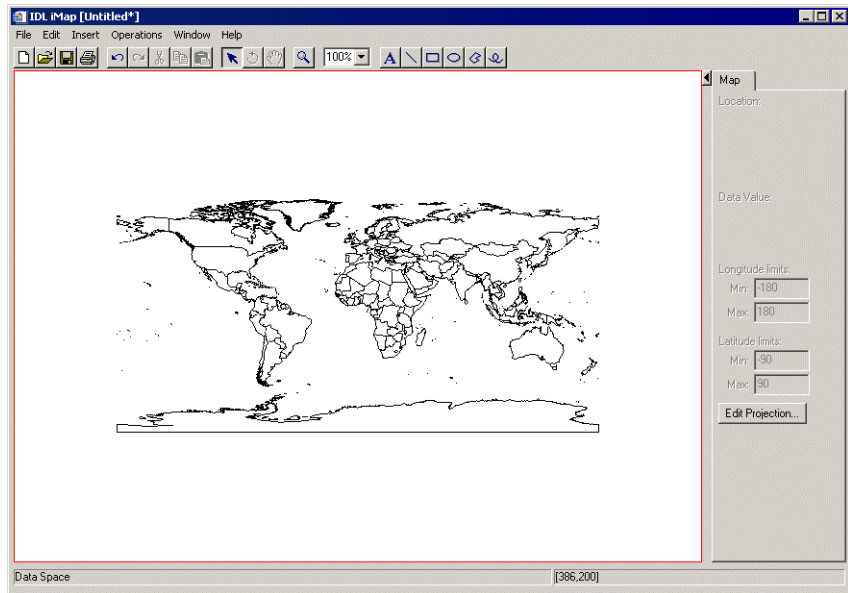

Figure 15-10: The Countries (High Res) Shapefile

## Inserting the Rivers

The **Insert** → **Map** → **Rivers** operation loads the `rivers.shp` file and displays the rivers as separate ShapePolylines (Figure 15-11) in the current dataspace, using the

current projection. If no projection is active, then IDL uses geographic coordinates. The ShapePolylines exist in a Rivers visualization container.

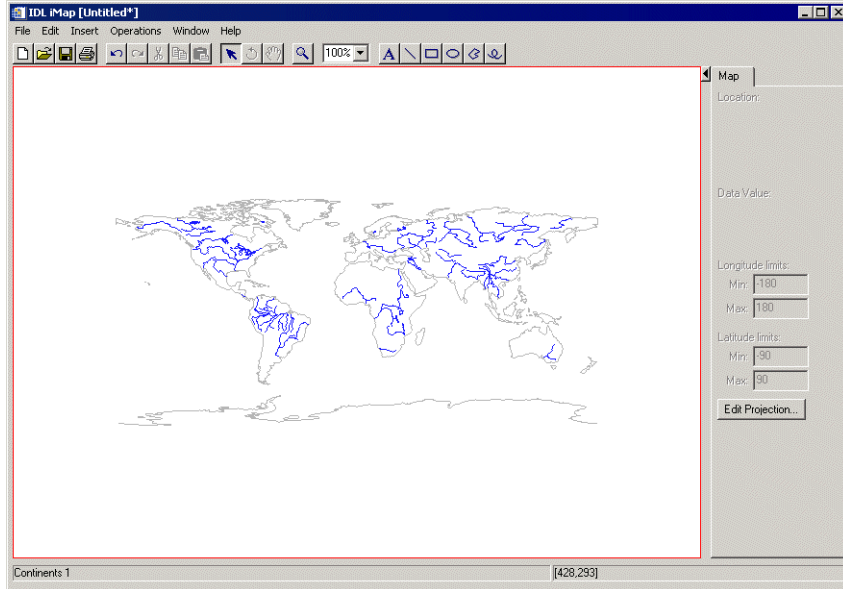

Figure 15-11: The Rivers Shapefile (Continents Added for Context)

## Inserting the Lakes

The **Insert** → **Map** → **Lakes** operation loads the `lakes.shp` file and displays the lakes as separate ShapePolygons (Figure 15-12) in the current dataspace, using the

current projection. If no projection is active, then IDL uses geographic coordinates. The ShapePolygons exist in a Lakes visualization container.

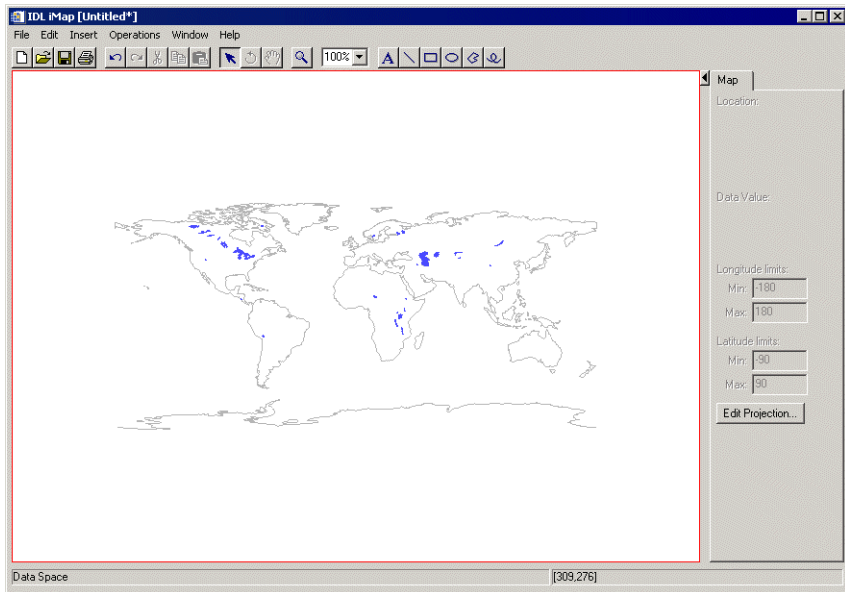

Figure 15-12: The Lakes Shapefile (Continents Added for Context)

## Inserting the United States

The **Insert** → **Map** → **United States** operation loads the `states.shp` file and displays the states as separate ShapePolygons (Figure 15-13) in the current dataspace,

using the current projection. If no projection is active, then IDL uses geographic coordinates. The ShapePolygons exist in a United States visualization container.

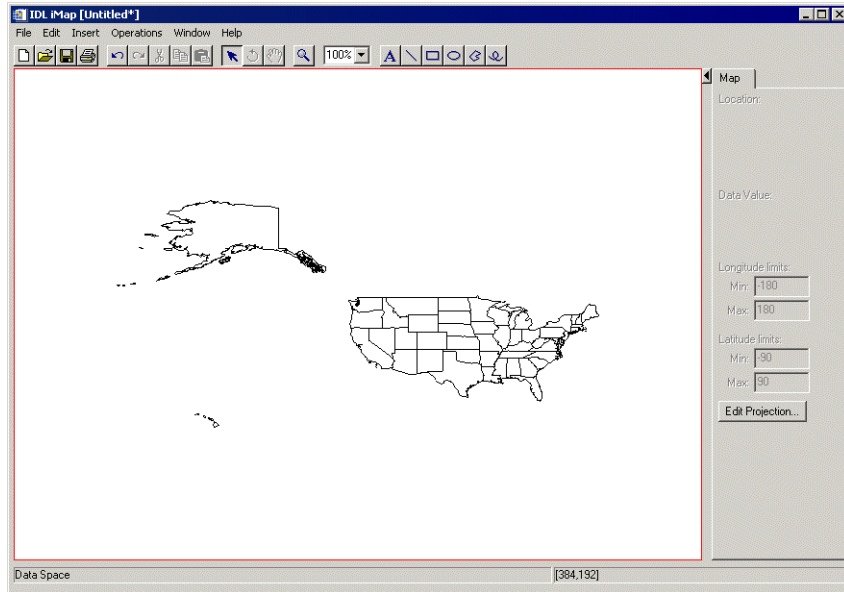

Figure 15-13: The United States Shapefile

## Inserting the Canadian Provinces

The **Insert** → **Map** → **Canadian Provinces** operation loads the `canadaprovince.shp` file and displays the provinces as separate ShapePolygons (Figure 15-14) in the current dataspace, using the current projection. If no projection

is active, then IDL uses default longitude-latitude coordinates. The ShapePolygons exist in a Canadian Provinces visualization container.

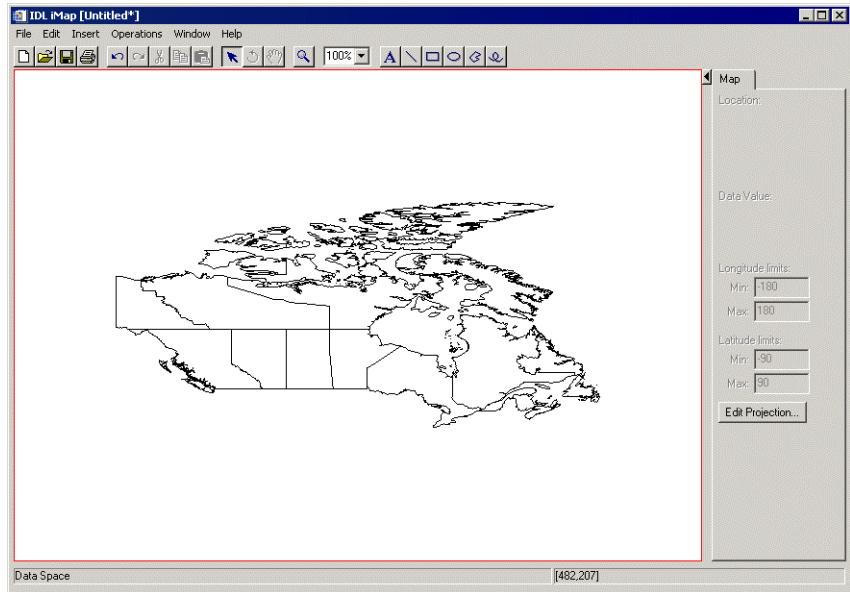

Figure 15-14: The Canadian Provinces Shapefile





# Appendix A

# iTools Interface Reference

This appendix describes the following common features of the IDL Intelligent Tools interface:

---

|   |     |   |     |
|---|-----|---|-----|
| <a href="#">Introduction to iTools Interface Elements</a> . . . . . | 352 | <a href="#">Help Menu</a> . . . . .           | 363 |
| <a href="#">File Menu</a> . . . . .                                 | 353 | <a href="#">File Toolbar</a> . . . . .        | 364 |
| <a href="#">Edit Menu</a> . . . . .                                 | 355 | <a href="#">Edit Toolbar</a> . . . . .        | 365 |
| <a href="#">Insert Menu</a> . . . . .                               | 358 | <a href="#">Manipulator Toolbar</a> . . . . . | 366 |
| <a href="#">Operations Menu</a> . . . . .                           | 359 | <a href="#">Annotation Toolbar</a> . . . . .  | 367 |
| <a href="#">Window Menu</a> . . . . .                               | 362 | <a href="#">Context Menu</a> . . . . .        | 368 |

# Introduction to iTools Interface Elements

The Standard IDL Intelligent Tools comprise six distinct tools: iImage, iPlot, iSurface, iContour, iVolume, and iMap. Each tool has a specific set of functions related to the type of data it is designed to use. In addition to these specific tasks, all four tools have a number of functions in common. This appendix describes those functions that all iTools have in common; for information about the functions unique to the individual iTools, refer to the chapters describing those tools.

This appendix is an overview of these menu items and toolbar buttons that are common to all iTools:

## Menu Bar Items

The following menus appear on the iTool menu bar:

- File Menu
- Edit Menu
- Insert Menu
- Operations Menu
- Window Menu
- Help Menu

## Toolbar Items

The following toolbars appear at the top of each iTool window:

- The File toolbar, containing the New, Open, Save, and Print buttons.
- The Edit toolbar, containing the Undo, Redo, Cut, Copy, and Paste buttons.
- The Manipulator toolbar, containing the Select, Rotate, and View Pan buttons.
- The View Zoom button and View Zoom drop-down list.
- The Annotation toolbar, containing the Text and line buttons as well as the Line, Rectangle, Oval, Polygon, and Freehand annotation buttons.



# File Menu

The File menu contains tools for creating, opening, printing and saving files, as well as tools for importing and exporting data and images. The File menu items are common to all standard iTools.

| Menu Selection   | Keyboard Accelerator | Function  |
|------------------|----------------------|---|
| New              | Ctrl+N               | Creates a new iTool of the specified type. Options: <b>iImage, iPlot, iSurface, iContour, iVolume, and iMap.</b>  |
| Open...          | Ctrl+O               | Opens a file for import into the current iTool. If this is a data file, such as an image file, ASCII file, or binary file, a new data object will be created and, if applicable, a new visualization will be created. |
| Import...        |                      | Imports an IDL variable or file to the current iTool. See “ <a href="#">Data Import Methods</a> ” on page 27 for details.   |
| Export...        |                      | Exports the data from the currently-selected object to the IDL main program level, or exports the current window to an image file.  |
| Save             | Ctrl+S               | Saves the state of the current iTool to a file. If the state has not been previously saved and has no filename, enter a filename.   |
| Save As...       |                      | Prompts you to enter a filename and then saves the state of the current iTool.  |
| Print Preview... |                      | Shows a preview of the visualization to print and allows you to reorient (Portrait or Landscape) as well as center, print, close, or change printer setup.  |
| Print...         | Ctrl+P               | Sends the current view of the contents of the graphics window to the specified printer via the standard Windows or Motif printer dialog.  |

Table A-6: The File Menu

| Menu Selection | Keyboard Accelerator | Function  |
|----------------|----------------------|---|
| Preferences... |                      | Displays the Preferences Browser. See <a href="#">“The Preferences Browser”</a> on page 95 for details.       |
| Exit           | Ctrl+Q               | Exits the iTool window, closing all visualizations and views within the window and removing them from memory. |

*Table A-6: The File Menu*

# Edit Menu

The Edit menu contains tools for editing and deleting data within the tool, retracing your steps with the Undo/Redo commands, and displaying properties for selected objects. The Edit menu items are common to all standard iTools.

| Menu Selection | Keyboard Accelerator | Function  |
|----------------|----------------------|---|
| Undo           | Ctrl+Z               | Nullifies the previous operation and restores the iTool to its state before that operation. The name of the previous operation appears after Undo.<br><br><b>Note</b> - Operations such as open, save, export, export variable, print, exit, and window moving and resizing cannot be undone. |
| Redo           | Ctrl+Y               | Nullifies the previous Undo command and restores the iTool to its state before the Undo command was issued. Any action that can be undone can also be redone.   |
| Cut            | Ctrl+X               | Deletes the selected item(s) and places a copy on the local clipboard.  |
| Copy           | Ctrl+C               | Copies the selected item to the local clipboard. If a view is copied, then a bitmap copy of that view (not the entire Window) is also put on the System clipboard.<br><br><b>Note</b> - You may change the magnification (resolution) of the bitmap copy using the Edit Copy property sheet.  |
| Paste          | Ctrl+V               | Pastes the current local clipboard contents into the selected view. If a view is pasted, it is added to the current Window layout and becomes the currently-selected view.  |

Table A-7: The Edit Menu

| Menu Selection | Keyboard Accelerator | Function   |
|----------------|----------------------|--|
| Paste Special  |                      | Pastes the current local clipboard contents into the selected view, and makes a reference to all contained data.   |
| Delete         | Del                  | Deletes the currently-selected item(s), without putting a copy on the local or system clipboards. Deletion can be reversed with Undo.  |
| Select All     |                      | Selects all items in the current view.   |
| Grouping       |                      | Select <b>Group</b> to add all selected objects to a group, <b>Ungroup</b> to remove them from the group.  |
| Order          |                      | Change the display order of the selected object(s). Choose from these options: <ul style="list-style-type: none"> <li>• <b>Bring to Front:</b> Move selected object(s) to the top display level.</li> <li>• <b>Send to Back:</b> Move selected object(s) to the bottom display level.</li> <li>• <b>Bring Forward:</b> Move selected object(s) up one display level.</li> <li>• <b>Send Backward:</b> Move selected object(s) down one display level.</li> </ul> |
| Style          |                      | Selections related to iTool's styles. <ul style="list-style-type: none"> <li>• <b>Apply Style:</b> Applies current style to your iTool visualization.</li> <li>• <b>Create Style from Selection:</b> Creates a new style from selected visualization items.</li> <li>• <b>Style Editor:</b> Brings up the <b>Style Editor</b> dialog.</li> </ul>   |
| Parameters...  |                      | Displays the Parameter Editor. See <a href="#">“Data Import Methods”</a> on page 27 for details.   |

Table A-7: The Edit Menu (Continued)

| <b>Menu Selection</b> | <b>Keyboard Accelerator</b> | <b>Function</b>   |
|-----------------------|-----------------------------|---|
| Properties...         |                             | Brings up the property sheet for the currently-selected item(s). If only the view is selected, the property sheet for the view layer is presented. Only one property sheet may be displayed at a time. If a different item or view is selected, the contents of the property sheet change to the properties of the new item or view. For grouped items, a single property sheet with the intersection of the properties is displayed. When the property values are not the same for the grouped items, those properties are set to undefined or default. Setting a property for a grouped item sets that property for all items in the group. |

*Table A-7: The Edit Menu (Continued)*

# Insert Menu

The Insert menu contains tools for adding visualization elements to the displayed data. Contents of the Insert menu vary from iTool to iTool.

| Menu Selection  | Function   |
|---|--|
| Visualization   | Inserts a new visualization into the current window. See <a href="#">“Inserting Visualizations”</a> on page 54 for details.  |
| View  | Inserts a new view into the current window. <ul style="list-style-type: none"> <li>• If the window is currently locked, this menu item will be grayed out.</li> <li>• If the window is not locked, the new view is added to the layout in the appropriate location, depending on the currently active layout.</li> </ul> |
| Dataspace   | Inserts data space. (useful when overplotting such as in iPlot)  |
| Axis  | Inserts a new axis. Choose from these options: <ul style="list-style-type: none"> <li>• X: inserts an additional X axis</li> <li>• Y: inserts an additional Y axis</li> <li>• Z: inserts an additional Z axis</li> </ul> See <a href="#">“Additional Axes”</a> on page 84 for details.                                   |
| New Legend  | Inserts a new legend for the data set or for the selected visualization(s) into the current window. See <a href="#">“Legends”</a> on page 77 for details.  |
| Legend Item   | Inserts a new item into your existing legend.  |
| Colorbar  | Inserts a colorbar for the selected item.<br><b>Note</b> - Only available for indexed color images.  |
| { Additional items vary depending on the iTool selected. } For example: |  |
| Light   | Inserts a new light into the current window. See <a href="#">“Lights”</a> on page 466 for details.   |
| Map   | Inserts a new map into the current window.   |

Table A-8: The Insert Menu

# Operations Menu

The Operations menu contains commands for performing operations on the selected data. Contents of the Operations menu vary from iTTool to iTTool.

| Menu Selection     | Function  |
|--------------------|---|
| Operations Browser | Displays a hierarchical nested list of all tools in the menus and toolbars. See <a href="#">“The Operations Browser”</a> on page 93 for details.  |
| Macros             | Selections related to iTTool’s macros. <ul style="list-style-type: none"> <li>• <b>Run Macro:</b> Select to run a macro.</li> <li>• <b>Start Recording:</b> Select to begin recording a macro.</li> <li>• <b>Stop Recording:</b> Select to cease macro recording.</li> <li>• <b>Macro Editor:</b> Select to bring up the <b>Macro Editor</b> dialog.</li> </ul> |
| Statistics         | Computes the statistical properties of the selected item(s), and displays the results in a separate dialog.<br>See <a href="#">“Displaying Statistics”</a> on page 127 for details.   |
| Histogram          | Displays a histogram plot of the selected data. See <a href="#">“Plotting a Histogram”</a> on page 126 for details.   |
| Filter             | Choose from these options: <ul style="list-style-type: none"> <li>• Convolution</li> <li>• Median</li> <li>• Smooth</li> </ul> See <a href="#">“Filtering”</a> on page 120.<br>{Additional filters vary depending on the iTTool selected.}  |
| Rotate             |   |

*Table A-9: The Operations Menu*

| Menu Selection                                 | Function  |
|--|---|
| Rotate Left<br>Rotate Right<br>Rotate by Angle | Rotate the selected data space left 90°.<br>Rotate the selected data space right 90°.<br>Specify the number of degrees to rotate the selected data space.<br><b>Note</b> - Rotate by Angle is absolute and always rotates relative to the original X-Y coordinate system for 2D visualizations. For 3D visualizations, Rotate by Angle is relative and does not remember the current rotation angle.  |
| Transform                                      | <ul style="list-style-type: none"> <li>• <b>Resample</b> — Resample the selected data using parameters specified in Resample property settings.</li> <li>• <b>Rotate Data</b> — Rotate the data within the visualization by a specified number of degrees without affecting the rest of the data space.</li> <li>• <b>Scale Data</b> — Scale the selected object by a specified scale factor.</li> </ul> See “ <a href="#">Transformations</a> ” on page 117 for details.<br>{Additional transformations vary depending on the iTool selected.} |

*Table A-9: The Operations Menu (Continued)*



| Menu Selection   | Function  |
|--|---|
| Morph  | <p>Choose from the following options:</p> <ul style="list-style-type: none"> <li>• <b>Dilate</b> is commonly known as “fill”, “expand”, or “grow.” It can be used to fill “holes” of a size equal to or smaller than the structuring element.</li> <li>• <b>Erode</b> does to the background what dilation does to the foreground. Given an image and a structuring element, erode can be used to remove islands smaller than the structuring element.</li> <li>• <b>Morph open</b> is simply an erosion operation followed by a dilation operation. Applying morph open more than once produces no further effect.</li> <li>• <b>Morph close</b> is simply a dilation operation followed by an erosion operation. Applying morph close more than once produces no further effect.</li> <li>• <b>Morph gradient</b> is the subtraction of an eroded version of the original image from a dilated version of the original image.</li> <li>• <b>Morph tophat</b> is implemented by first applying the opening operator to the original image, then subtracting the result from the original image. Applying tophat shows the bright peaks within the image.</li> </ul> <p>See “<a href="#">Morphing</a>” on page 125 for details.</p> |
| <hr/> { Additional items vary depending on the iTool selected. } <hr/> |   |

*Table A-9: The Operations Menu (Continued)*

# Window Menu

The Window menu contains commands for displaying the Data, Operations and Visualization browsers, for zooming in and out of the display, for modifying the window layout, and for displaying a log of system messages. The Window menu items are common to all iTools.

| Menu Selection        | Function   |
|-----------------------|--|
| Data Manager          | Displays the Data Manager for the current iTool. See <a href="#">“About the Data Manager”</a> on page 24 for details.  |
| Visualization Browser | Displays a hierarchical nested list of all visualization elements in the display area. See <a href="#">“The Visualization Browser”</a> on page 90 for details.   |
| Canvas Zoom           | Set to increase or decrease magnification of the entire iTool window without moving the observer’s “eye.” <ul style="list-style-type: none"> <li>• <b>800%</b></li> <li>• <b>400%</b></li> <li>• <b>200%</b></li> <li>• <b>100%</b></li> <li>• <b>75%</b></li> <li>• <b>50%</b></li> <li>• <b>25%</b></li> </ul> Default is 100%. See <a href="#">“Canvas Zoom”</a> on page 70 for more information. |
| Zoom on Resize        | If this menu item is checked, views will be resized whenever a visualization is zoomed in any way.<br><br>By default, the view will not be resized if zoom is performed.   |
| Layout...             | Displays the window layout dialog, which allows the user to change the current view layout and the window dimensions. See <a href="#">“Window Layouts”</a> on page 73 for details.   |
| Fit to View           | Select to fit window to view.  |

Table A-10: The Window Menu

# Help Menu

The Help menu contains commands for displaying online help and information about the iTools. The Help menu items are common to all iTools.

| Menu Selection                      | Function  |
|-------------------------------------|---|
| Help on iTools                      | Displays help for the iTools system.  |
| Help on the iTools Data Manager     | Displays help on the Data manager.  |
| Help on the iTools Parameter Editor | Displays help on the Parameter Editor   |
| Help on Selected Item               | Displays help for the item selected in the iTool visualization or browser window. |
| Help on this iTool                  | Displays help for the current iTool.  |
| About iTools                        | Displays a dialog describing the iTools and giving the version number.            |

*Table A-11: The Help Menu*

---





**Note**

In the Operations and Preferences browser windows, help for the selected item is also available on the context menu.

---

# File Toolbar

The File toolbar contains the following buttons:

| Button  | Tool Name | Function  |
|---|-----------|---|
|  | New       | Creates a new iTool of the same type as the current tool with no data or visualizations.  |
|  | Open      | Opens a file for import into the current iTool. If this is a data file, such as an image file, ASCII file, or binary file, a new data object will be created and, if applicable, a new visualization will be created. |
|  | Save      | Saves the state of the current iTool to a file. If the state has not been previously saved and has no filename, enter a filename. The saved file is cross-platform.   |
|  | Print     | Prints the entire contents of the graphics window.  |

*Table A-12: File Toolbar Buttons*

# Edit Toolbar

The Edit Toolbar contains the following buttons:





| Button  | Tool Name | Function   |
|---|-----------|--|
|    | Undo      | Nullifies the previous operation and restores the iTool to its state before that operation.<br><b>Note</b> - Operations such as open, save, export, export variable, print, exit, and window moving and resizing cannot be undone. |
|    | Redo      | Nullifies the previous Undo command and restores the iTool to its state before the Undo command was issued. Any action that can be undone can also be redone.  |
|    | Cut       | Deletes the selected item(s) and places a copy on the local clipboard. If the window layout is locked, you will be asked if a copy of the view should be placed on the System clipboard.   |
|    | Copy      | Copies the selected item to the local clipboard. If a view is copied, then a bitmap copy of that view (not the entire Window) is also put on the System clipboard.   |
|  | Paste     | Pastes the current local clipboard contents into the selected view. If a view is pasted, it is added to the current Window layout and becomes the currently-selected view.   |

Table A-13: Edit Toolbar Buttons

# Manipulator Toolbar

The Manipulator Toolbar contains the following buttons:











| Button  | Tool Name | Function  |
|---|-----------|---|
|    | Select    | Click to enter select mode. The arrow pointer is displayed, and objects can be selected in the display area. Click to select an object; a selection box appears around the current selection.   |
|    | Rotate    | Click to enter rotate mode. A rotation sphere appears around the currently selected object. <ul style="list-style-type: none"> <li>• Position the mouse pointer on an axis, and the axis rotation pointer is displayed. Drag in the desired direction to rotate the object along the axis.</li> <li>• Position the mouse pointer anywhere on the selected object, and the free rotation pointer is displayed. Drag in the desired direction to rotate the object freely.</li> </ul> |
|    | View Pan  | Click and drag across the view to pan.  |
|  | View Zoom | Click to enter zoom mode. The zoom cursor is displayed, and dragging the mouse closer to or farther from the center of the canvas decreases or increases magnification at the initial point of clicking.  |
|  | View Zoom | Click to select a magnification percentage for the entire view.   |

Table A-14: Manipulator Toolbar Buttons

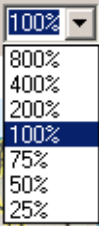
# Annotation Toolbar

The Annotation Toolbar contains the following buttons:

| Button  | Tool Name | Function  |
|---|-----------|---|
|  | Text      | Click to enter text annotation mode. The insert pointer is displayed, and text can be entered from the keyboard.  |
|  | Line      | Click to enter line annotation mode. The crosshairs pointer is displayed. Click at the starting point for the line and drag in the desired direction. Release the mouse button to terminate the line. |
|  | Rectangle | Click to enter rectangle annotation mode.   |
|  | Oval      | Click to enter oval annotation mode.  |
|  | Polygon   | Click to create a polygon annotation. Click to define vertices, double-click to complete polygon.   |
|  | Freehand  | Click to enter freehand annotation mode. The crosshairs pointer is displayed. Click at a starting point and drag to create the desired shape. Release the mouse button to complete the polygon.       |

*Table A-15: Annotation Toolbar Buttons*

# Context Menu

Right-clicking on the visualization window brings up a context menu at that location. The context menu is common to all iTools, and it contains the following menu items:

| Menu Selection | Description  |
|----------------|--|
| Cut            | Deletes the selected item(s) and places a copy on the local clipboard. If the window layout is locked, you will be asked if a copy of the view should be placed on the System clipboard. |
| Copy           | Copies the selected item to the local clipboard. If a view is copied, then a bitmap copy of that view (not the entire Window) is also put on the System clipboard.                       |
| Paste          | Pastes the current local clipboard contents into the selected view. If a view is pasted, it is added to the current Window layout and becomes the currently-selected view.               |
| Delete         | Deletes the currently-selected item(s), without putting a copy on the local or system clipboards. Deletion can be reversed with Undo.  |
| Grouping:      | Grouping gives you the advantage of allowing desired items to operate together and be manipulated as a single unit.  |
| Group          | Groups the currently-selected items into a single unit.  |
| Ungroup        | If the selected item is currently a group, then it is ungrouped.   |
|                | <b>Note</b> - You cannot group items across separate visualization and annotation layers.  |

*Table A-16: The Context Menu*



| Menu Selection   | Description   |
|--|---|
| Order:<br>Bring To Front<br>Send To Back<br>Bring Forward<br>Send Backward | Brings the selected item(s) to the front of the graphics hierarchy.<br>Sends the selected item(s) to the back of the graphics hierarchy.<br>Bring the selected item(s) forward one position in the graphics hierarchy.<br>Send the selected item(s) back one position in the graphics hierarchy.  |
| Export to IDL  | Exports the currently selected item(s) to your IDL session.   |
| Parameters...  | Brings up the parameter editor for the currently selected item(s).  |
| Properties...  | Brings up the property sheet for the currently selected item(s). If only the view is selected, the property sheet for the view layer is presented. Only one property sheet may be displayed at a time. If a different item or view is selected, the contents of the property sheet change to the properties of the new item or view. For grouped items, a single property sheet with the intersection of the properties is displayed. When the property values are not the same for the grouped items, those properties are set to undefined or default. Setting a property for a grouped item sets that property for all items in the group. |

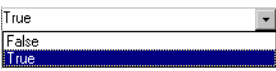

*Table A-16: The Context Menu (Continued)*





# Appendix B

# Property Controls

The following user interface controls are used in iTool property sheets. The general function of these controls is described here. Refer to the individual property descriptions in [Appendix C, “Operations Properties”](#) and [Appendix D, “Visualization Properties”](#) for specific information on how to set individual property controls.

| Control Type | Function   |
|--------------|--|
| Boolean      |  Click the browse button  to expand the list. Select either of the two choices ( <b>Show</b> or <b>Hide</b> , <b>True</b> or <b>False</b> , etc.) from the list. |

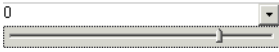
*Table B-17: Controls Used in Property Sheets*

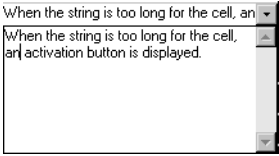
| Control Type | Function   |
|--------------|--|
| Number       | <p>If the number is editable, type in a new value. You may be restricted to whole numbers or a range of numbers. Entering a value outside of the valid range causes the number to snap to the nearest allowable value.</p>     |
|              |  <p>If a slider is displayed, slide the marker to select a new value.</p>   |
|              |  <p>If a spinner control is displayed, click, or click and hold the up or down buttons to change the value.</p>                               |
| String       |  <p>Enter a string in the text box. If the string exceeds the length of the text box, a browse button is provided to expand the text box.</p> |

*Table B-17: Controls Used in Property Sheets (Continued)*

| Control Type | Function   |
|--------------|--|
| Color        | <p>Select a color from the palette displayed in the color selector:</p>  <p>Or click <b>Custom Color</b> (UNIX users right-click the color bar at the bottom of the window) to specify RGB or HSL values:</p> <div style="display: flex; justify-content: space-between;"> <div style="width: 60%;">  <p style="text-align: center;">Windows Color Picker</p> </div> <div style="width: 35%; font-style: italic;"> <p><i>Windows users:</i> enter Hue, Sat, Lum or Red, Green, Blue values and click OK to apply the new values. Click Add to Custom Colors to save your values.</p> </div> </div> <div style="display: flex; justify-content: space-between; margin-top: 20px;"> <div style="width: 60%;">  <p style="text-align: center;">UNIX Color Picker</p> </div> <div style="width: 35%; font-style: italic;"> <p><i>UNIX users:</i> drag the Red, Green, Blue or Hue, Lightness, Saturation sliders to change values, and click OK to apply the new values.</p> </div> </div> |

Table B-17: Controls Used in Property Sheets (Continued)



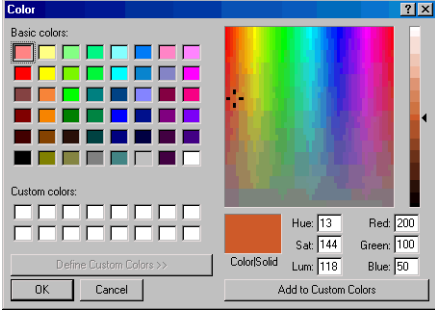
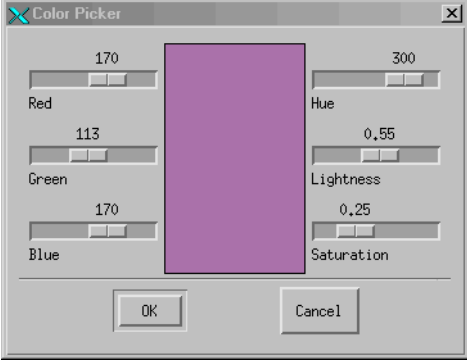

| Control Type   | Function  |  |
|----------------|---|--|
| Line Style     |    | <p>Select a line style from the list. To make the line invisible, select <b>No Line</b>.</p>   |
| Line Thickness |    | <p>Select a line thickness from the list. Numbers indicate line thickness in pixels. Use the scroll bar to display additional items.</p>   |
| Symbol         |    | <p>Select a symbol to appear at regular intervals on the selected line from the list. To remove a symbol from a line, select <b>No Symbol</b>. Use the scroll bar to display additional items.</p> |
| String List    |    | <p>Select an item from the list. Use the scroll bar to display additional items.</p>   |
| User Defined   |  | <p>Click the <b>Edit</b> button to display the user-defined property control.</p>  |

Table B-17: Controls Used in Property Sheets (Continued)

## Appendix C

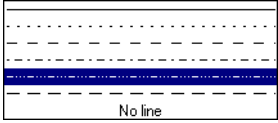
# Operations Properties

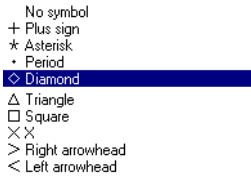
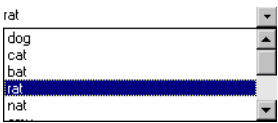
This appendix describes the following properties of the IDL Intelligent Tools interface found in the Operations Browser of each iTool:

---

|                               |     |                        |     |
|-------------------------------|-----|------------------------|-----|
| The Operations Browser        | 376 | Morphing Properties    | 394 |
| Macros Properties             | 377 | Crop Properties        | 395 |
| Statistics Properties         | 378 | Region Grow Properties | 396 |
| Filter Properties             | 380 | Contour Properties     | 398 |
| Rotate Properties             | 387 | Image Properties       | 399 |
| Rotate Properties             | 387 | Surface Properties     | 400 |
| Transform Properties          | 388 | Volume Properties      | 401 |
| Map Projection Properties     | 392 | Image Plane Properties | 403 |
| Map Register Image Properties | 393 |                        |     |

# The Operations Browser

The Operations Browser provides a hierarchical tree view of the tools and operations available from the iTool Operations menu. The Operations Browser is used to set properties for operations and tools used in the iTool window. See “[The Operations Browser](#)” on page 93 for details on how to display and use the Operations Browser.

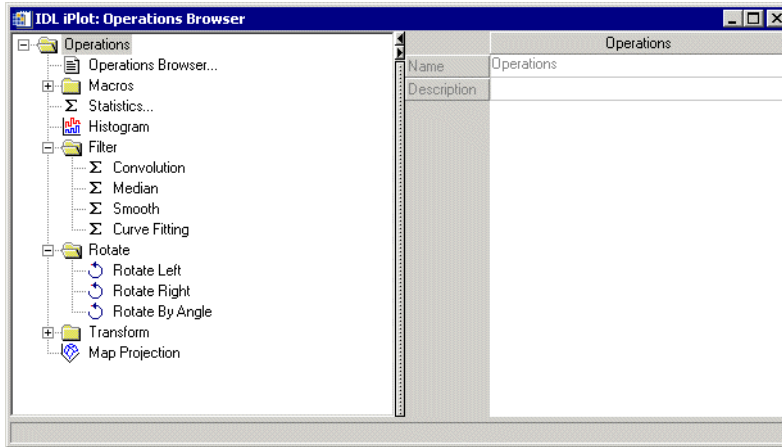

Figure C-15: The Operations Browser

The property sheet for each operation displayed in the Operations Browser contains the Name and Description properties described in the following table. For each property, the type of control and the values that can be assigned are listed. For a description of how a particular control is used, refer to [Appendix B, “Property Controls”](#)

| Property    | Control Type: Options  |
|-------------|--|
| Name        | <b>String:</b> Name assigned to this statistics dialog. Edit the text to change the name.        |
| Description | <b>String:</b> Description of this statistics function. Edit the text to change the description. |

Table C-18: Statistics Operation Properties



# Macros Properties

Macros provide a shortcut mechanism that lets you quickly and automatically repeat a sequence of interactive operations. The Macros tools appears in the Operation Browser for all iTools. See [Chapter 8, “Working with Macros”](#) for details on how to use macros.

This browser has no properties that can be configured other than Name and Description.

# Statistics Properties

The Statistics tool displays statistical information relating to the currently selected object or group of objects. The Statistics tool appears in the Operation Browser for all iTools. See [“Displaying Statistics”](#) on page 127 for details on how to use the Statistics tool.

This browser has no properties that can be configured other than Name and Description.

# Histogram Properties

The Histogram tool displays a histogram plot of the data selected in the iTool window. The Histogram tool appears in the Operation Browser for all iTools. See [“Plotting a Histogram”](#) on page 126 for details on how to use the Histogram tool.

Histogram has no configurable properties other than Name and Description.

# Filter Properties

The following properties control the iTool filters.

## Convolution Properties

Convolution smooths data by using a weighted moving average. Convolution filter properties appear on the Operations Browser for all iTools. See “[Convolution Filter](#)” on page 122 for details on applying convolution.

For each property, the type of control and the values that can be assigned are listed. For a description of how a particular control is used, refer to.

| Property    | Control Type: Options  |
|-------------|--|
| Show dialog | <p><b>Boolean:</b> Display the Convolution Kernel Editor dialog when the Convolution filter is selected from the <b>Operations</b> → <b>Filter</b> menu. Choose <b>True</b> to display the dialog, or <b>False</b> to apply the Convolution filter without displaying the dialog.</p> <p>Default = <b>True</b></p> |

*Table C-19: Convolution Filter Properties*

| Property          | Control Type: Options   |
|-------------------|---|
| Filter            | <p><b>String List:</b> The default filter. Select from the following list:</p> <ul style="list-style-type: none"> <li>• User defined</li> <li>• Tent</li> <li>• Boxcar</li> <li>• Gaussian</li> <li>• Edge Horizontal</li> <li>• Edge Vertical</li> <li>• Edge Diagonal Right</li> <li>• Edge Diagonal Left</li> <li>• Line Horizontal</li> <li>• Line Vertical</li> <li>• Line Diagonal Right</li> <li>• Line Diagonal Left</li> <li>• Laplacian</li> <li>• Emboss</li> </ul> <p>Default = <b>Tent</b></p> |
| Number of columns | <p><b>Number:</b> Width of the filter (applies only to Tent, Boxcar, and Gaussian). Default = <b>3</b></p>  |
| Number of rows    | <p><b>Number:</b> Height of the filter (applies only to Tent, Boxcar, and Gaussian). Default = <b>1</b> for 1D data, <b>3</b> for 2D data</p>   |
| Kernel            | <p><b>User Defined:</b> Display the <b>Convolution Kernel Editor</b> dialog. Click <b>Edit</b> to display the dialog.</p>   |
| Center            | <p><b>Boolean:</b> Select <b>True</b> (centered) or <b>False</b> (no centering).<br/>Default = <b>True</b></p>  |
| Auto normalize    | <p><b>Boolean:</b> Select <b>True</b> (for automatic normalizing) or <b>False</b> (no automatic normalizing). Default = <b>True</b></p>   |
| Scale factor      | <p><b>Number:</b> Value to be divided into each result. Default is calculated from the kernel.</p>  |

Table C-19: Convolution Filter Properties (Continued)

| Property          | Control Type: Options  |
|-------------------|--|
| Bias offset       | <b>Number:</b> Value to be added to each result, after scale factor. Default is calculated from the kernel.  |
| Edge values       | <b>Boolean:</b> Select for edge value type: <ul style="list-style-type: none"> <li>• <b>Zero result</b></li> <li>• <b>Wrap around</b></li> <li>• <b>Repeat last value</b></li> <li>• <b>Zero pad</b></li> </ul> Default = <b>Wrap around</b> |
| Use invalid value | <b>Boolean:</b> Select <b>True</b> to use the invalid value to filter out missing data, or <b>False</b> (invalid value not used). Default = <b>False</b>   |
| Invalid value     | <b>Number:</b> Missing or invalid value that should be ignored. Default = <b>0</b>   |
| Replacement value | <b>Number:</b> Value used to replace missing results. Default = <b>0</b>   |

Table C-19: Convolution Filter Properties (Continued)

## Median Properties

Median smoothing replaces each point with the *median* (a value in an ordered set of values with an equal number of values above and below it) of the one- or two-dimensional neighborhood of a given width. See “[Median Filter](#)” on page 121 for details on applying the median filter.

For each property, the type of control and the values that can be assigned are listed. For a description of how a particular control is used, refer to [Appendix B](#), “[Property Controls](#)”.

| Property | Control Type: Options   |
|----------|---|
| WIDTH    | <b>Number:</b> Width of the smooth window. Enter a whole number between 1 (no smoothing) and the width of the data. Default = 3 |

Table C-20: Median Filter Properties

| Property     | Control Type: Options  |
|--------------|--|
| Even Average | <b>Boolean:</b> If set to true and the Width property is set to an even number, the operation will return the average of the two middle numbers. |

Table C-20: Median Filter Properties

## Smooth Properties

The Smooth filter reduces noise within an image by applying low pass filters. Smooth filter properties appear on the Operations Browser for all iTools. See “[Smooth Filter](#)” on page 120 for details on applying the smooth filter.

For each property, the type of control and the values that can be assigned are listed. For a description of how a particular control is used, refer to [Appendix B, “Property Controls”](#).

| Property | Control Type: Options  |
|----------|--|
| WIDTH    | <b>Number:</b> Width of the smooth window. Enter a whole number between 1 (no smoothing) and the width of the data.<br>Default = 3 |

Table C-21: Smooth Filter Properties

## Roberts Filter Properties

Roberts filter appears on the Operations Browser for the iImage tool only. Roberts filter has no configurable properties other than Name and Description. For more information on the Roberts filter, see “[ROBERTS](#)” in the *IDL Reference Guide* manual.

## Sobel Filter Properties

Sobel filter appears on the Operations Browser for the iImage tool only. Sobel filter has no configurable properties other than Name and Description. For more information on the Sobel filter, see “[SOBEL](#)” in the *IDL Reference Guide* manual.

## Unsharp Mask Properties

An unsharp-mask filter can be applied to any two-dimensional array or a TrueColor image. The unsharp mask enhances the contrast between neighboring pixels in an image, and is widely used for astronomical images and for digital photographs. For more information on unsharp masking a plot, see “[Unsharp Mask Filter](#)” on page 123.

| Property             | Control Type: Options   |
|----------------------|---|
| Show dialog          | <b>Boolean:</b> Display the Unsharp Mask Editor dialog when the Unsharp Mask filter is selected from the <b>Operations</b> → <b>Filter</b> menu. Choose <b>True</b> to display the dialog, or <b>False</b> to apply the Unsharp Mask filter without displaying the dialog.<br>Default = <b>True</b> |
| Amount of filter (%) | <b>Number:</b> Click and slide to select percentage amount of filter to be applied.<br>Default = <b>100%</b>  |
| Radius in pixels     | <b>Number:</b> Click and slide to select filter radius in pixels.<br>Default = 3  |
| Clipping threshold   | <b>Number:</b> Click and slide to select clipping threshold.<br>Default = 0   |

Table C-22: Unsharp Mask Filter Properties

## Curve Fitting Properties

Curve fitting properties appear on the Operations Browser for the iPlot tool only. See “[Curve Fitting](#)” on page 292 for details on applying curve fitting to a plot.



For each property, the type of control and the values that can be assigned are listed. For a description of how a particular control is used, refer to [Appendix B, “Property Controls”](#).

| Property    | Control Type: Options  |
|-------------|--|
| Show dialog | <b>Boolean:</b> Display the Curve Fitting Editor dialog when the Curve Fitting filter is selected from the <b>Operations</b> → <b>Filter</b> menu. Choose <b>True</b> to display the dialog, or <b>False</b> to apply the Curve Fitting filter (the default curve fitting model - linear - will be used) without displaying the dialog.<br><br>Default = <b>True</b> |

*Table C-23: Curve Fitting Properties*

| Property     | Control Type: Options  |
|--------------|--|
| Model name   | <p><b>String List:</b> Model to use in curve fitting. Select a model from the list. Choose from these values:</p> <ul style="list-style-type: none"> <li>• Linear</li> <li>• Quadratic</li> <li>• Cubic</li> <li>• Quartic</li> <li>• Quintic</li> <li>• Exponential</li> <li>• Gompertz</li> <li>• Logsquare</li> <li>• Hyperbolic</li> <li>• Hyperbolic trigonometric</li> <li>• Logistic</li> <li>• Geometric</li> <li>• Trigonometric summation</li> <li>• Trigonometric product</li> <li>• Variable sinc</li> <li>• Gaussian</li> <li>• Gaussian + constant</li> <li>• Gaussian + linear</li> <li>• Gaussian + quadratic</li> </ul> <p>Default = Linear</p> |
| Parameter(s) | <p><b>Number:</b> Initial parameter(s) and result(s). Values may be edited here.</p> <p>Default = Varies</p>   |

*Table C-23: Curve Fitting Properties*

# Rotate Properties

The following properties control the iTool Rotate tools. Rotate properties appear on the Operations Browser for all iTools (for iImage it is Rotate or Flip).

## Rotate Left Properties

Rotate Left has no configurable properties other than Name and Description.

## Rotate Right Properties

Rotate Right has no configurable properties other than Name and Description.

## Rotate By Angle Properties

Rotate by Angle has no configurable properties other than Name and Description.

## Flip Horizontal

Flip Horizontal has no configurable properties other than Name and Description.

## Flip Vertical

Flip Vertical has no configurable properties other than Name and Description.

# Transform Properties

The following properties control the iTool Transform tools.

## Resample Properties

The Resample transform resamples the selected data using the resampling factors and method specified in these properties. Resample Transform properties appear on the Operations Browser for all iTools. See [“Resample”](#) on page 117 for details on how to resample data.

For each property, the type of control and the values that can be assigned are listed. For a description of how a particular control is used, refer to [Appendix B, “Property Controls”](#).

| Property             | Control Type: Options   |
|----------------------|---|
| 1st dimension factor | <b>Number:</b> The resampling factor for the first dimension (X). Edit the number to change the value. Default = 2  |
| 2nd dimension factor | <b>Number:</b> The resampling factor for the second dimension (Y). Edit the number to change the value. Default = 2   |
| 3rd dimension factor | <b>Number:</b> The resampling factor for the third dimension (Z). Edit the number to change the value. Default = 2  |
| Interpolation method | <p><b>String List:</b> Method of interpolation to use in resampling. Select a method from the list. Choose from these values:</p> <ul style="list-style-type: none"> <li>• <b>Nearest neighbor:</b> Assign the value of the nearest pixel to the pixel in the output image. Fastest method, but may cause jagged edges.</li> <li>• <b>Linear:</b> Surveys the two closest pixels, drawing a line between them and designating a value along that line as the output pixel value.</li> <li>• <b>Cubic:</b> Use cubic polynomial waveforms instead of linear waveforms. Most accurate method, but may require more processing time.</li> </ul> <p>Default = <b>Nearest neighbor</b></p> |

Table C-24: Resample Transform Properties

## Rotate Data Properties

The Rotate Data operation allows you to rotate the data within the visualization by a specified number of degrees without affecting the rest of the data space (graphical objects and axes). See “[Rotation](#)” on page 113 in for details on using the Rotate Data operation.

The following properties control the Rotate Data tool. For each property, the type of control and the values that can be assigned are listed. For a description of how a particular control is used, refer to [Appendix B, “Property Controls”](#).

| Property             | Control Type: Options   |
|----------------------|---|
| Angle                | <b>Number:</b> The angle of rotation in degrees clockwise.<br>Default = 0   |
| X center offset      | <b>Number:</b> X subscript of the center of rotation. Default = 0   |
| Y center offset      | <b>Number:</b> Y subscript of the center of rotation. Default = 0   |
| Magnification        | <b>Number:</b> Magnification factor. Default = 1  |
| Interpolation method | <b>String List:</b> Method of interpolation to use when rotating. Select a method from the list. Choose from these values: <ul style="list-style-type: none"> <li>• <b>Nearest neighbor:</b> Assign the value of the nearest pixel to the pixel in the output image. Fastest method, but may cause jagged edges.</li> <li>• <b>Linear:</b> Surveys the two closest pixels, drawing a line between them and designating a value along that line as the output pixel value.</li> <li>• <b>Cubic:</b> Use cubic polynomial waveforms instead of linear waveforms. Most accurate method, but may require more processing time.</li> </ul> Default = <b>Nearest neighbor</b> |
| Extrapolate missing  | <b>Boolean:</b> Extrapolate the value of a missing pixel from the value of nearby pixels. Default = <b>True</b>   |

Table C-25: Rotate Data Properties

| Property      | Control Type: Options   |
|---------------|---|
| Missing value | <p><b>Number:</b> A value to be substituted for pixels in the rotated image that fall outside the bounds of the unrotated image. This property is only used if the Extrapolate missing property is set to false.</p> <p>Default = 0</p> |
| Pivot         | <p><b>Boolean:</b> If set to true, the image will be rotated around the point defined by the X center offset and Y center offset. If set to false, the image will be rotated around its center.</p> <p>Default = <b>False</b></p>       |

*Table C-25: Rotate Data Properties*

## Scale Data Properties

The Scale Data operation scales the selected objects by a specified scale factor. Scale Data properties appear on the Operations Browser for all iTools. See “[Scaling](#)” on page 65 for details on using the Scale Data operation.

The following properties control the Scale Data tool. For each property, the type of control and the values that can be assigned are listed. For a description of how a particular control is used, refer to [Appendix B, “Property Controls”](#).

| Property     | Control Type: Options  |
|--------------|--|
| Show dialog  | <p><b>Boolean:</b> Display the Scale Data Editor dialog when Scale Data is selected from the <b>Operations</b> → <b>Scale Data</b> menu. Choose <b>True</b> to display the dialog, or <b>False</b> to apply the Scale Data without displaying the dialog.</p> <p>Default = <b>True</b></p> |
| Scale Factor | <p><b>Number:</b> Scale the selected data by this factor. Edit the number to change the factor that appears in the Scale Factor dialog. Scale Factor may be positive or negative.</p> <p>Default = 2</p>   |

*Table C-26: Scale Data Properties*

## Invert Image Properties

Invert Image Transform properties appear on the Operations Browser for iImage only. The operation has no unique properties.

## Byte Scale Properties

Byte Scale properties appear on the Operations Browser for iImage only. For each property, the type of control and the values that can be assigned are listed. For a description of how a particular control is used, refer to [Appendix B, “Property Controls”](#).

| Property          | Control Type: Options  |
|-------------------|--|
| Automatic Min/Max | <b>Boolean:</b> Automatically compute minimum and maximum values? Choose <b>True</b> or <b>False</b> . Default = <b>True</b> |
| Minimum cutoff    | <b>Number:</b> Minimum value of array to be considered. Edit the number to change the value. Default = 0                     |
| Maximum cutoff    | <b>Number:</b> Maximum value of array to be considered. Edit the number to change the value. Default = 255                   |
| Bottom byte       | <b>Number:</b> Minimum value of scaled result. Edit the number to change the value. Range = 0-255. Default = 0               |
| Top byte          | <b>Number:</b> Maximum value of scaled result. Edit the number to change the value. Range = 0-255. Default = 255             |

*Table C-27: Byte Scale Transform Properties*

### Note

When working with byte data, the default bytescale range is always 0-255. Therefore, even if data is bytescaled from 0-100, it will display using 0-255. This may cause visualized data to appear darker.

# Map Projection Properties

The map projection functionality displays image and contour data that are georeferenced and mapped to particular projections. See [Chapter 15, “Working with Maps”](#) for details on how to use mapping functionality.

For a comprehensive list of map projection properties, see [“Applying a Map Projection”](#) on page 326.

Map Projection has no configurable properties other than Show dialog.

| Property    | Control Type: Options   |
|-------------|---|
| Show dialog | <p><b>Boolean:</b> Display the Map Projection dialog when <b>Operations</b> → <b>Map Projection</b> is chosen. Choose <b>True</b> to display the dialog, or <b>False</b> to apply the Map Projection dialog without displaying the dialog.</p> <p>Default = <b>True</b></p> |

*Table C-28: Map Projection Properties*



# Map Register Image Properties

The map projection functionality displays image and contour data that are georeferenced and mapped to particular projections. See [Chapter 15, “Working with Maps”](#) for details on how to use mapping functionality.

Map Register Image has the following configurable properties.

| Property       | Control Type: Options   |
|----------------|---|
| Origin (x)     | <b>Number:</b> Set the longitudinal minimum in degrees.<br>Default = 0    |
| End (x)        | <b>Number:</b> Set the longitudinal maximum in degrees.<br>Default = 0    |
| Pixel size (x) | <b>Number:</b> Set the longitudinal pixel size in degrees.<br>Default = 0 |
| Origin (y)     | <b>Number:</b> Set the latitudinal minimum in degrees.<br>Default = 0     |
| End (y)        | <b>Number:</b> Set the latitudinal maximum in degrees.<br>Default = 0     |
| Pixel size (y) | <b>Number:</b> Set the latitudinal pixel size in degrees.<br>Default = 0  |

*Table C-29: Map Register Properties*

# Morphing Properties

Morphing is available for `UIImage`, `UIImageSurface`, and `UIImageContour`.

Mathematical morphology is a method of processing digital images on the basis of shape. Six morphing options are available for use in `UIImageTools`: `dilate`, `erode`, `morphOpen`, `morphClose`, `morphGradient`, and `morphTopHat`. All six options share the same properties. See “[Morphing](#)” on page 125 in for details on morphing data.

For each property, the type of control and the values that can be assigned are listed. For a description of how a particular control is used, refer to [Appendix B, “Property Controls”](#).

| Property        | Control Type: Options  |
|-----------------|--|
| Structure Shape | <p><b>String List:</b> The shape of the structuring element used in the morph operation. Choose from these values:</p> <ul style="list-style-type: none"> <li>• <b>Square</b></li> <li>• <b>Circle</b></li> </ul> <p>Default = <b>Square</b></p> |
| Structure Width | <p><b>Number:</b> The width of the structuring element.</p> <p>Default = 3</p>   |

*Table C-30: Morphological Filter Properties*

# Crop Properties

Cropping is available for the iImage tool. The iImage cropping operation allows you to crop one or more selected images at a specified location and specified dimensions.

See “[iImage Tool Operations](#)” on page 229 for details on cropping.

For each property, the type of control and the values that can be assigned are listed. For a description of how a particular control is used, refer to [Appendix B, “Property Controls”](#).

| Property | Control Type: Options   |
|----------|---|
| X        | <b>Number:</b> The X cropping value.<br>Default = 0   |
| Y        | <b>Number:</b> The Y cropping value.<br>Default = 0   |
| Width    | <b>Number:</b> The crop operation width setting.<br>Default = <width of selected image>   |
| Height   | <b>Number:</b> The crop operation height setting.<br>Default = <height of selected image>   |
| Units    | <b>String List:</b> <ul style="list-style-type: none"> <li>• <b>Data</b></li> <li>• <b>Pixel</b></li> </ul> Default = <b>Data</b> |

*Table C-31: Crop Properties*

# Region Grow Properties

Region growing expands a selected area to include nearby pixels that fall within a threshold range of the current selection. See “[REGION\\_GROW](#)” in the *IDL Reference Guide* manual for additional details. For a description of how a particular control is used, refer to [Appendix B](#), “Property Controls”.

| Property            | Control Type: Options   |
|---------------------|---|
| Region grow method  | <p><b>String List:</b> The method used to select pixels that are similar to the current selection. Choose from these values:</p> <ul style="list-style-type: none"> <li>• <b>By threshold:</b> The expanded region includes neighboring pixels that fall within the range defined by the Threshold minimum and Threshold maximum values.</li> <li>• <b>By standard deviation:</b> The expanded region includes neighboring pixels that fall within the range of the mean of the region’s pixel values plus or minus the given multiplier times the sample standard deviation as follows:<br/> <math display="block">\text{Mean} \pm \text{StdDevMultiplier} * \text{StdDev}</math>           where Mean is the mean value of the selected pixels, StdDevMultiplier is the value specified by the Standard Deviation Multiplier property, and StdDev is the standard deviation of the selected pixels.</li> </ul> <p>Default = <b>By threshold</b></p> |
| Pixel search method | <p><b>String List:</b> Specifies which pixels should be considered during region growing. Four-neighbor searching searches only the neighbors that are exactly one unit in distance from the current pixel; Eight-neighbor searching searches all neighboring pixels.</p> <p>Choose from these values:</p> <ul style="list-style-type: none"> <li>• <b>4-neighbor</b></li> <li>• <b>8-neighbor</b></li> </ul> <p>Default = <b>4-neighbor</b></p>  |

Table C-32: Region Grow Operation Properties

| Property                      | Control Type: Options  |
|-------------------------------|--|
| Threshold to use              | <p><b>String List:</b> Specifies the threshold values to use. Choose from these values:</p> <ul style="list-style-type: none"> <li>• <b>Source ROI/Image threshold:</b> Base the threshold values on the pixel values in the currently selected region.</li> <li>• <b>Explicit:</b> Specify the threshold values using the Threshold minimum and Threshold maximum properties.</li> </ul> <p>Default = <b>Source ROI/Image threshold</b></p>                           |
| Threshold minimum             | <p><b>Number:</b> The explicitly specified minimum threshold value.<br/>Default = 0</p>  |
| Threshold maximum             | <p><b>Number:</b> The explicitly specified maximum threshold value.<br/>Default = 256</p>  |
| Standard deviation multiplier | <p><b>Number:</b> The number of standard deviations to use if the region growing method is <b>By standard deviation</b>. Default = 1</p>   |
| For an RGB(A) image use       | <p><b>String List:</b> If the image has separate color channels, use the selected channel when growing the region. Choose from these values:</p> <ul style="list-style-type: none"> <li>• <b>Luminosity:</b> Luminosity values</li> <li>• <b>Red Channel:</b> Red values</li> <li>• <b>Green Channel:</b> Green values</li> <li>• <b>Blue Channel:</b> Blue values</li> <li>• <b>Alpha Channel:</b> Transparency values.</li> </ul> <p>Default = <b>Luminosity</b></p> |

Table C-32: Region Grow Operation Properties (Continued)

# Contour Properties

Contour Properties appear on the Operations Browser for iImage and iSurface only. The following properties control the contour operation. For each property, the type of control and the values that can be assigned are listed. For a description of how a particular control is used, refer to [Appendix B, “Property Controls”](#).

| Property   | Control Type: Options   |
|------------|---|
| N_LEVELS   | <p><b>Number:</b> Set the number of contour levels.<br/>Default = 5</p>   |
| Value      | <p><b>Number:</b> Set the contour value to use.<br/>Default = 0</p>   |
| Projection | <p><b>Boolean:</b> Choose the contour type:</p> <ul style="list-style-type: none"> <li>• <b>Planar</b></li> <li>• <b>3D</b></li> </ul> <p>Default = <b>Planar</b></p> |

*Table C-33: Contour Properties*

# Image Properties

Image Properties appear on the Operations Browser for iSurface and iContour only. Image has no configurable properties other than Name and Description.

# Surface Properties

Surface Properties appear on the Operations Browser for iImage and iContour only. Surface has no configurable properties other than Name and Description.



# Volume Properties

Volume Properties appear on the Operation Browser for the iVolume tool only.

## Image Plane

Image Plane has no configurable properties other than Name and Description.

## Isosurface

For each property, the type of control and the values that can be assigned are listed. For a description of how a particular control is used, refer to [Appendix B, “Property Controls”](#).

| Property    | Control Type: Options  |
|-------------|--|
| Show Dialog | <p><b>Boolean:</b> Display the Isosurface Value Selector dialog when Isosurface is selected from the <b>Operations</b> → <b>Volume</b> menu. Choose <b>True</b> to display the dialog, or <b>False</b> to apply the isosurface without displaying the dialog.</p> <p>Default = <b>True</b></p> |

*Table C-34: Isosurface Properties*

## Render Volume

Render Volume has no configurable properties other than Name and Description.

## Interval Volume

For each property, the type of control and the values that can be assigned are listed. For a description of how a particular control is used, refer to [Appendix B, “Property Controls”](#).

| Property    | Control Type: Options  |
|-------------|--|
| Show Dialog | <p><b>Boolean:</b> Display the Isosurface Value Selector dialog when Isosurface is selected from the <b>Operations</b> → <b>Volume</b> menu. Choose <b>True</b> to display the dialog, or <b>False</b> to apply the isosurface without displaying the dialog.</p> <p>Default = <b>True</b></p> |

*Table C-35: Interval Volume Properties*

# Image Plane Properties

Image Plane Properties appear on the Operation Browser for the iVolume tool only.

| Property        | Control Type: Options   |
|-----------------|---|
| Show            | <p><b>Boolean:</b> Display the image plane after Image Plane is selected from the <b>Operations</b> → <b>Volume</b> → <b>Image Plane</b> menu. Choose <b>True</b> to display, or <b>False</b> to apply the image plane without displaying.</p> <p>Default = <b>True</b></p> |
| Opacity control | <p><b>Boolean:</b> Choose opacity control type.</p> <ul style="list-style-type: none"> <li>• Use opacity table</li> <li>• Opaque</li> <li>• Opacity value</li> </ul> <p>Default = <b>Use opacity table</b></p>  |
| Opacity value   | <p><b>Number:</b> Set opacity value.</p> <p>Default = 50</p>  |
| Orientation     | <p><b>Boolean:</b> Choose image plane orientation.</p> <ul style="list-style-type: none"> <li>• X</li> <li>• Y</li> <li>• Z</li> </ul> <p>Default = <b>X</b></p>  |
| Opacity         | <p><b>Number:</b> Set opacity.</p> <p>Default = 1</p>   |
| Color           | <p><b>Boolean:</b> Set color.</p> <p>Default = White [255, 255, 255]</p>  |
| Bottom color    | <p><b>Boolean:</b> Set bottom color.</p> <p>Default = White [255, 255, 255]</p>   |

Table C-36: Image Plane Properties

| Property              | Control Type: Options  |
|-----------------------|--|
| Depth offset          | <b>Number:</b> Set depth offset value.<br>Default = 1  |
| Skip zero opacity     | <b>Boolean:</b> Choose <b>True</b> to skip zero opacity or <b>False</b> to use zero opacity.<br>Default = <b>True</b>  |
| Texture interpolation | <b>Boolean:</b> Set texture interpolation type. <ul style="list-style-type: none"> <li>• Nearest neighbor</li> <li>• Bilinear</li> </ul> Default = <b>Nearest neighbor</b> |

*Table C-36: Image Plane Properties*

## Launch ilmage

Launch iImage has no configurable properties other than Name and Description.



## Appendix D

# Visualization Properties

This appendix describes the following visualization properties of the IDL Intelligent Tools interface found in the Visualization Browser of each iTool:

---

|  |     |  |     |
|--|-----|--|-----|
| <a href="#">Introduction to Visualization Properties</a> . . . | 406 | <a href="#">Data Space Properties</a> . . . . .          | 413 |
| <a href="#">The Visualization Browser</a> . . . . .            | 407 | <a href="#">Visualization Type Properties</a> . . . . .  | 417 |
| <a href="#">Window Properties</a> . . . . .                    | 408 | <a href="#">2D Annotation Layer Properties</a> . . . . . | 480 |
| <a href="#">View Properties</a> . . . . .                      | 410 | <a href="#">Legend Properties</a> . . . . .              | 491 |
| <a href="#">Visualization Layer Properties</a> . . . . .       | 411 |  |     |

# Introduction to Visualization Properties

The IDL iTools comprise six distinct tools: iImage, iPlot, iSurface, iContour, iVolume, and iMap. Each tool has a specific set of functions related to the type of data it is designed to use. In addition to these specific tasks, all five tools have a number of functions in common.

This appendix describes those functions that all iTools have in common; for information about the functions unique to the individual iTools, refer to

- [Chapter 10, “Working with Images”](#)
- [Chapter 11, “Working with Surfaces”](#)
- [Chapter 12, “Working with Contours”](#)
- [Chapter 13, “Working with Plots”](#)
- [Chapter 14, “Working with Volumes”](#)
- [Chapter 15, “Working with Maps”](#)

This appendix describes the properties common to various iTool visualizations.

# The Visualization Browser

The Visualization Browser provides a hierarchical tree view of all objects displayed in the iTool window. The Visualization Browser is used to select objects and to display the property sheets for selected objects. See [“The Visualization Browser”](#) on page 90 for details on how to display and use the Visualization Browser.

The Visualization Browser displays a list of the contents of the iTool window in the left pane. The property sheet for the object currently selected in the left pane can be displayed in the right pane of the Visualization Browser window by clicking on the small arrows to the top-right of the left pane and top-left of the right pane (in the middle if both are displayed). For example, to display the properties of the current window, select Window in the left pane of the Visualization Browser as shown in the following figure.

# Window Properties

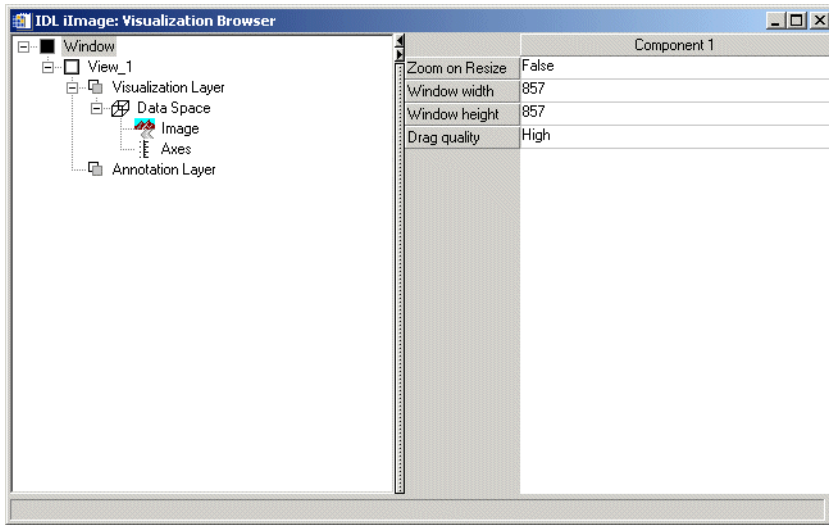

Figure D-16: The Visualization Browser with Window Properties Displayed

These properties control the display of the iTool window. For each property, the type of control and the values that can be assigned are listed. For a description of how a particular control is used, refer to [Appendix B, “Property Controls”](#).

| Property       | Control Type: Values  |
|----------------|---|
| Zoom on Resize | <b>Boolean:</b> Zoom visualization upon resize of window? Choose <b>True</b> or <b>False</b> . Default = <b>False</b>   |
| Window Width   | <b>Number:</b> Width of the current iTool window in pixels. Edit the number to change the value. Default = 640<br><b>Note</b> - The minimum width of the window correlates to the width of the menubar. |
| Window Height  | <b>Number:</b> Height of the current iTool window in pixels. Edit the number to change the value. Default = 512   |

Table D-37: iTool Window Properties



| Property     | Control Type: Values  |
|--------------|---|
| Drag Quality | <b>String:</b> Drag quality to define the level of detail shown when a visualization is translated, scaled, zoomed, or otherwise moved by mouse. Choose <b>High</b> , <b>Medium</b> , or <b>Low</b> . Default = <b>High</b> . |

*Table D-37: iTool Window Properties*

All property sheets displayed in the Visualization Browser, with the exception of the Window property sheet displayed above, include the Name, Description, and Show properties described in the following table:

| Property    | Control Type: Values   |
|-------------|--|
| Name        | <b>String:</b> Name assigned to this view. Edit the text to change the name.               |
| Description | <b>String:</b> Description of this view. Edit the text to change the description.          |
| Show        | <b>Boolean:</b> Show this view? Choose <b>True</b> or <b>False</b> . Default = <b>True</b> |

*Table D-38: Name and Description Properties*

# View Properties

Each iTool window contains at least one view. If multiple views have been created from the Window Layout dialog, each view will be listed separately.

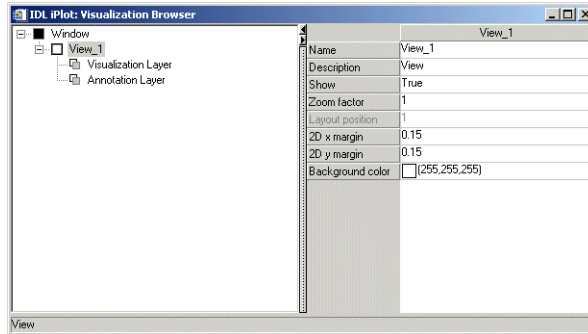

Figure D-17: Visualization Browser with View Properties Displayed

These properties control the display of the view or views contained in the iTool window. For each property, the type of control and the values that can be assigned are listed. For a description of how a particular control is used, refer to [Appendix B, “Property Controls”](#)

| Property         | Control Type: Values   |
|------------------|--|
| Zoom Factor      | <b>Number:</b> Increase or decrease magnification of the view by this factor. Edit the number to change the value. Default = 1 |
| Layout Position  | Displays the currently selected layout view  |
| X margin         | <b>Number:</b> Set horizontal margin size. Valid range = 0.0 to 0.49.  |
| Y margin         | <b>Number:</b> Set vertical margin size. Valid range = 0.0 to 0.49.  |
| Background color | <b>Color:</b> Sets the background color of the contained Visualization Layer. Default = [255, 255, 255] (white)                |

Table D-39: View Properties

# Visualization Layer Properties

The Visualization Layer contains the data space and, for three-dimensional objects, the lights, associated with a visualization.

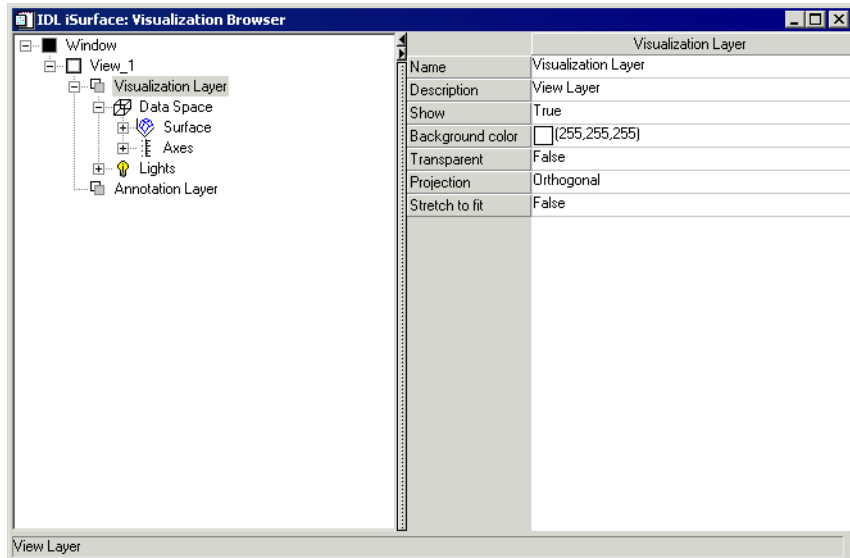

*Figure D-18: Visualization Browser with Visualization Layer Properties Displayed*

These properties control the visualization of the data space. For each property, the type of control and the values that can be assigned are listed. For a description of how a particular control is used, refer to [Appendix B, “Property Controls”](#).

| Property         | Control Type: Values   |
|------------------|--|
| Background Color | <b>Color:</b> Visualization layer background color. Transparent must be set to <b>False</b> . Click to choose from the default color palette, or specify RGB values. Default = [255, 255, 255] (white) |

*Table D-40: Visualization Layer Properties*

| Property         | Control Type: Values  |
|------------------|---|
| Transparent      | <b>Boolean:</b> Make visualization layer transparent? Choose <b>True</b> or <b>False</b> . Default = <b>True</b>  |
| Projection       | <b>String List:</b> Projection method for displaying the visualization layer. Select a method from the list. Choose from these values: <ul style="list-style-type: none"> <li>• <b>Orthogonal:</b> Orthographic projection (objects are projected onto the visualization layer along lines perpendicular to the view plane)</li> <li>• <b>Perspective:</b> Objects are projected onto the visualization layer along perspective lines that converge in the distance.</li> </ul> Default = <b>Orthogonal</b> |
| Stretch to Fit   | <b>Boolean:</b> Stretch visualization layer to fit window? Choose <b>True</b> or <b>False</b> . Default = <b>False</b>  |
| Depth cue bright | <b>Number:</b> The distance of the near Z plane used for depth cueing. Objects closer than this distance will be painted in their normal color. Objects further than this distance will fade into the background.   |
| Depth cue dim    | <b>Number:</b> The distance of the far Z plane used for depth cueing. Objects further than this distance will be painted in the background color. Setting <b>Depth cue bright</b> and <b>Depth cue dim</b> to the same value will disable depth cueing.   |

*Table D-40: Visualization Layer Properties (Continued)*

# Data Space Properties

The data space contains the data type(s) displayed within the visualization, plus the axes associated with the data. It is a transparent-walled bounding box by default. When the data space walls are not transparent, some display artifacts may be visible in certain situations. See [“Rendering Objects at Data Space Depth”](#) on page 416 for more information.

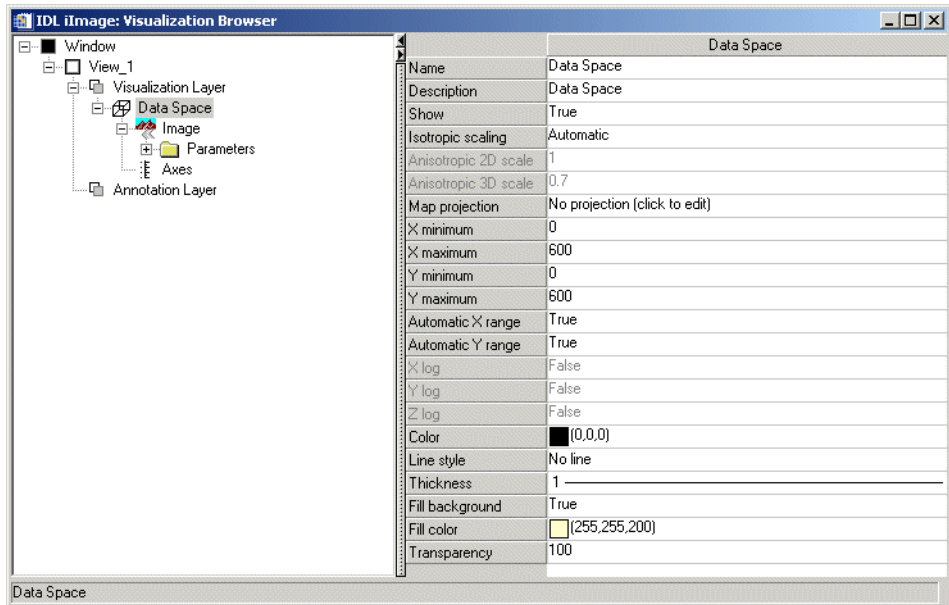

Figure D-19: Visualization Browser with Data Space Properties Displayed

These properties control the visualization of the data space. For each property, the type of control and the values that can be assigned are listed. For a description of how a particular control is used, refer to [Appendix B, “Property Controls”](#).

| Property             | Control Type: Values   |
|----------------------|--|
| Isotropic scaling    | <p>Scaling method. Select a method from the list. Choose between these values:</p> <ul style="list-style-type: none"> <li>• <b>Automatic:</b> automatic scaling</li> <li>• <b>Isotropic:</b> isotropic scaling</li> <li>• <b>Anisotropic:</b> anisotropic scaling</li> </ul> <p>Default = <b>Automatic</b></p> <p><b>Note</b> - If this property is set to <b>Automatic</b>, then:</p> <ol style="list-style-type: none"> <li>1. If any visualization within the dataspace has its <b>Isotropic scaling</b> property set to True, the dataspace will be automatically set to isotropic, and the <b>Anisotropic 2D/3D scale</b> properties will be desensitized.</li> <li>2. If none of the visualizations are isotropic, the dataspace will be automatically set to anisotropic, and the appropriate <b>Anisotropic scale</b> property will be sensitized for either 2D or 3D data.</li> </ol> |
| Anisotropic 2D scale | Presentation scale factor applied along Y axis   |
| Anisotropic 3D scale | Presentation scale factor applied along Z axis   |
| Map projection       | Default = No projection (click to edit)  |
| X Minimum            | <b>Number:</b> Minimum value for X coordinate of data set.   |
| X Maximum            | <b>Number:</b> Maximum value for X coordinate of data set.   |
| Y Minimum            | <b>Number:</b> Minimum value for Y coordinate of data set.   |
| Y Maximum            | <b>Number:</b> Maximum value for Y coordinate of data set.   |
| Z Minimum            | <b>Number:</b> Minimum value for Z coordinate of 3-D data set.   |

*Table D-41: Data Space Properties*

| Property                  | Control Type: Values   |
|---------------------------|--|
| Z Maximum                 | <b>Number:</b> Maximum value for Z coordinate of 3-D data set.   |
| Automatic X range updates | <b>Boolean:</b> Automatically updates the range of X values. Choose <b>True</b> or <b>False</b> . Default = <b>True</b>  |
| Automatic Y range updates | <b>Boolean:</b> Automatically updates the range of Y values. Choose <b>True</b> or <b>False</b> . Default = <b>True</b>  |
| Automatic Z range updates | <b>Boolean:</b> Automatically updates the range of Z values. Choose <b>True</b> or <b>False</b> . Default = <b>True</b>  |
| X log                     | <b>Boolean:</b> Determines X axis type. Choose <b>True</b> (logarithmic) or <b>False</b> (linear). Default = <b>False</b> .  |
| Y log                     | <b>Boolean:</b> Determines Y axis type. Choose <b>True</b> (logarithmic) or <b>False</b> (linear). Default = <b>False</b> .  |
| Z log                     | <b>Boolean:</b> Determines Z axis type. Choose <b>True</b> (logarithmic) or <b>False</b> (linear). Default = <b>False</b> .  |
| Color                     | <b>Color:</b> Data space bounding box border color. Border Style must not be <b>No line</b> . Click to choose from the default color palette, or specify RGB values. Default = [0, 0, 0] (black) |
| Linestyle                 | <b>Line Style:</b> Data set bounding box border line style. Select a line style from the list. Default = <b>No line</b>  |
| Thickness                 | <b>Line Thickness:</b> Data set bounding box border line thickness. Select a thickness from the list. Default = <b>1</b> .   |
| Fill Background           | <b>Boolean:</b> Fills data space background with background color. Choose <b>True</b> or <b>False</b> . Default = <b>True</b>  |
| Fill Color                | <b>Color:</b> Data space background color. Fill Background must be set to <b>True</b> . Click to choose from the default color palette, or specify RGB values. Default = [255, 255, 200] (cream) |
| Transparency              | <b>Number:</b> Transparency of data space background from 0% to 100%. Fill Background must be set to <b>True</b> . Move slider to select a new percentage. Default = 100                         |

Table D-41: Data Space Properties (Continued)

## Rendering Objects at Data Space Depth

The depth buffer is a record of the depth at which each pixel of a graphic primitive is rendered on a graphics device. This is typically used to control the visual positioning of objects in front or behind other objects. (See [“Controlling the Depth of Objects in a View”](#) in Chapter 2 of the *Object Programming* manual for more information on depth buffers.)

Data space walls are polygon objects that are transparent by default. In unusual circumstances when the walls are not transparent, *and* when another object is drawn in the same plane, display artifacts may be visible when the objects are transformed. This results from the normal competition between z-buffer and polygon rasterization operations. To avoid any display artifacts, reposition the object so that it is not in the same plane as the data space wall, or make the wall completely transparent.



# Visualization Type Properties

There are many types of visualizations that can be displayed in the six iTools. Each data type has its own property sheet, which can be displayed in the Visualization Browser. For more information, see:

- [“Image”](#) on page 418
- [“Plot”](#) on page 421
- [“Plot 3D”](#) on page 425
- [“Surface”](#) on page 428
- [“Contour”](#) on page 432
- [“Volume”](#) on page 437
- [“Isosurface”](#) on page 443
- [“Interval Volume”](#) on page 445
- [“Image Plane”](#) on page 447
- [“Colorbar”](#) on page 450
- [“Histogram”](#) on page 454
- [“Axes”](#) on page 458
- [“Lights”](#) on page 466
- [“Polygonal ROI”](#) on page 469
- [“IDL Graphics Objects”](#) on page 471
- [“Map Grid”](#) on page 472
- [“ShapePolygon”](#) on page 476
- [“ShapePolyline”](#) on page 478
- [“ShapePoint”](#) on page 479

# Image

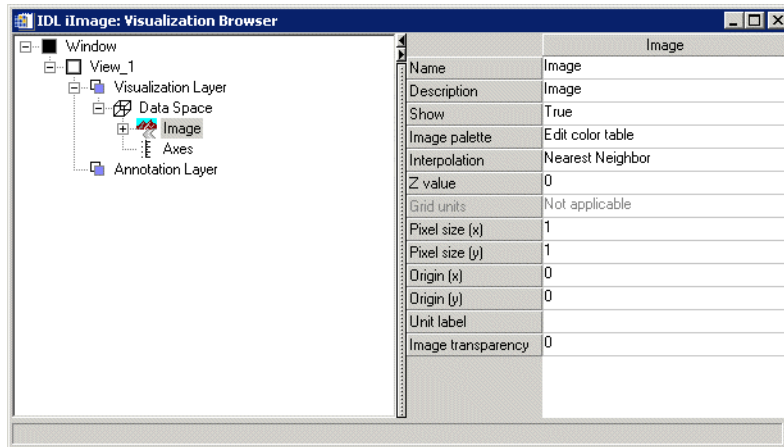

Figure D-20: Visualization Browser with Image Properties Displayed

These properties control image object visualizations. For each property, the type of control and the values that can be assigned are listed. For a description of how a particular control is used, refer to [Appendix B, “Property Controls”](#).

| Property      | Control Type: Values  |
|---------------|---|
| Image Palette | <b>User Defined:</b> By selecting <b>Edit Color</b> → <b>Table Edit</b> access the color table to manipulate color values |

Table D-42: Image Properties

| Property       | Control Type: Values  |
|----------------|---|
| Interpolation  | <p><b>String List:</b> Method used for interpolating the image. Select a method from the list. Choose from these values:</p> <ul style="list-style-type: none"> <li>• <b>Nearest Neighbor:</b> Assign the value of the nearest pixel to the pixel in the output image. Fastest method, but may cause jagged edges.</li> <li>• <b>Bilinear:</b> Create a weighted average based on the nearness and brightness of the closest four pixels, and assign that value to the pixel in the output image.</li> </ul> <p>Default = <b>Nearest Neighbor</b></p> |
| Z value        | <p><b>Number:</b> Z value of plane on to which to project the image. Edit the number to change the value.</p> <p><b>Note -</b> If the Z value is zero then the image visualization is considered to be 2D. If the Z value is nonzero, then the image visualization is considered to be 3D, and the dataspace associated with this image will be automatically switched to 3D.</p> <p>Default = 0</p>  |
| Pixel size (x) | <p><b>Number:</b> Pixel size for <i>x</i> value.</p> <p>Default = 1</p>   |
| Pixel size (y) | <p><b>Number:</b> Pixel size for <i>y</i> value.</p> <p>Default = 1</p>   |
| Origin (x)     | <p><b>Number:</b> Origin point for <i>x</i> value.</p> <p>Default = 0</p>   |
| Origin (y)     | <p><b>Number:</b> Origin point for <i>y</i> value.</p> <p>Default = 0</p>   |
| Units          | <p><b>Number:</b> Number of units.</p> <p>Default = None</p>  |

Table D-42: Image Properties (Continued)

| Property           | Control Type: Values   |
|--------------------|--|
| Image transparency | <p><b>Number:</b> Transparency of the image, 0% - 100%. Move the slider to change the value. Default = 0 (no transparency)</p> <p><b>Note -</b> The transparency is changed by adding an alpha channel to the image. If your image has an alpha channel then the Transparency property is ignored.</p> |
| Row Order          | <p><b>String List:</b> Select an order from the list. Choose from these values:</p> <ul style="list-style-type: none"> <li>• <b>Bottom-to-top</b></li> <li>• <b>Top-to-bottom</b></li> </ul> <p>Default = <b>Bottom-to-top</b></p>   |

*Table D-42: Image Properties (Continued)*

# Plot

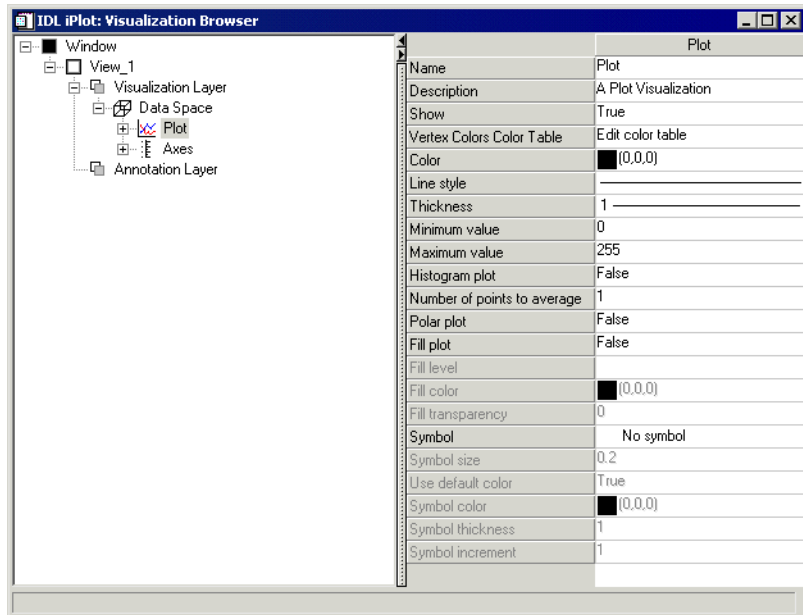

Figure D-21: Visualization Browser with Plot Properties Displayed

These properties control plot object visualizations. For each property, the type of control and the values that can be assigned are listed. For a description of how a particular control is used, refer to [Appendix B, “Property Controls”](#).

| Property                     | Control Type: Values  |
|------------------------------|---|
| Vertex Colors<br>Color Table | <p><b>User Defined:</b> By selecting <b>Edit Color</b> → <b>Table Edit</b> access the color table to manipulate plot color values</p>  |
| Color                        | <p><b>Color:</b> Color for the plot line. Click to choose from the default color palette, or specify RGB values. Default = [0, 0, 0] (black)</p>  |
| Line style                   | <p><b>Line Style:</b> Style for the plot line. Select a style from the list. Default = ————— (solid line)</p>   |
| Thickness                    | <p><b>Line Thickness:</b> Thickness for the plot line. Select a thickness from the list. Default = 1</p>  |

Table D-43: Plot Properties

| Property          | Control Type: Values  |
|-------------------|---|
| Minimum value     | <b>Number:</b> Minimum value to include in the plot. Edit the number to change the value.   |
| Maximum value     | <b>Number:</b> Maximum value to display in the plot. Edit the number to change the value.   |
| Histogram plot    | <b>Boolean:</b> Display plot as a histogram? Choose <b>True</b> or <b>False</b> . Default = <b>False</b>  |
| Points to average | <b>Number:</b> Number of points to average when drawing the plot. Edit to change the value. Default = 1   |
| Polar plot        | <b>Boolean:</b> Display plot as a polar plot? Choose <b>True</b> or <b>False</b> . Default = <b>False</b>   |
| Fill plot         | <b>Boolean:</b> Fill between plot lines? Choose <b>True</b> or <b>False</b> . Default = <b>False</b>  |
| Fill level        | <b>Number:</b> Level at which to begin the plot fill. Edit the number to change the value. Default = 0  |
| Fill color        | <b>Color:</b> Color for the plot fill. Fill transparency must be less than 100%. Click to choose from the default color palette, or specify RGB values. Default = [128, 128, 128] |
| Fill transparency | <b>Number:</b> Transparency of the plot fill from 0% to 100%. Move the slider to change the value. Default = 0  |
| Symbol            | <b>Symbol:</b> Symbol to appear at regular intervals on the plot line. Choose a symbol from the list. Default = <b>No symbol</b>  |
| Symbol size       | <b>Number:</b> Factor from 0 - 1 determining the size of the selected symbol. Move slider to change the size. Default = 0.2   |
| Use default color | <b>Boolean:</b> Activate Symbol color property. Choose <b>True</b> or <b>False</b> . Default = <b>False</b>   |
| Symbol color      | <b>Color:</b> Color for the selected symbol. Click to choose from the default color palette, or specify RGB values. Default = [0, 0, 0] (black)                                   |
| Symbol thickness  | <b>Number:</b> Line thickness from 1 - 9.9 for the selected symbol. Move slider to change the thickness. Default = 1.   |

Table D-43: Plot Properties (Continued)

| Property         | Control Type: Values   |
|------------------|--|
| Symbol increment | <b>Number:</b> Interval at which symbols will be displayed on the plot line. Influenced by <b>Number of points to average</b> (listed previously). Edit to change the value. Default = 1 |

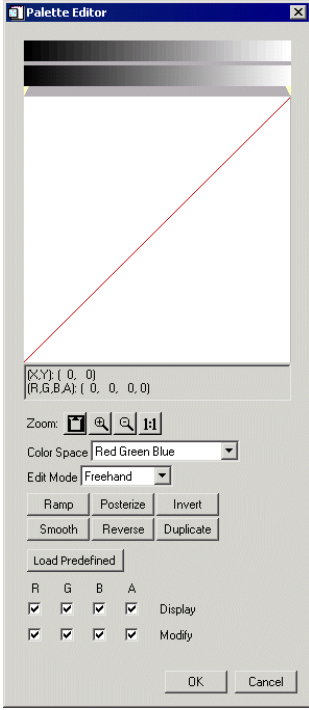
*Table D-43: Plot Properties (Continued)*



## Plot 3D

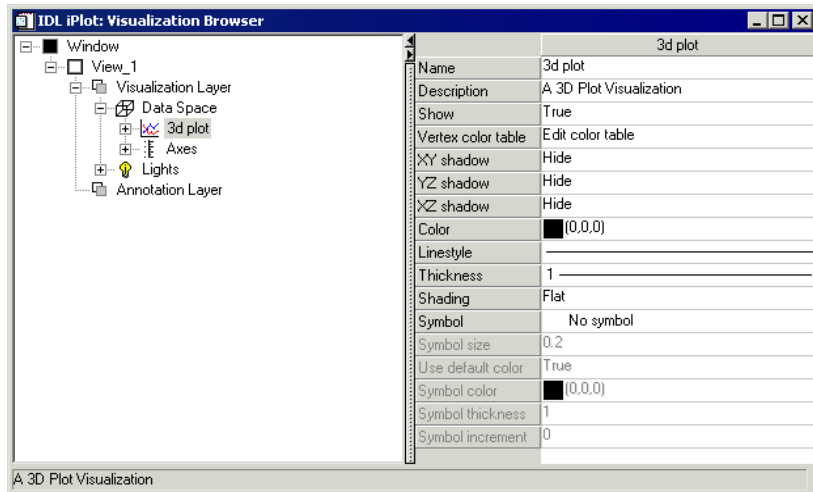
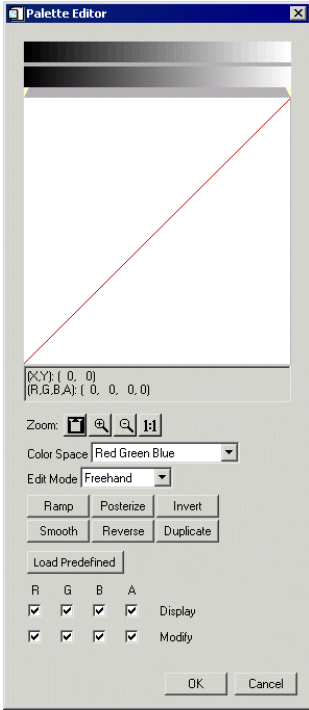

Figure D-22: Visualization Browser with 3D Plot Properties Displayed

These properties control three-dimensional plot object visualizations. For each property, the type of control and the values that can be assigned are listed. For a

description of how a particular control is used, refer to [Appendix B, “Property Controls”](#).

| Property           | Control Type: Values   |
|--------------------|--|
| Vertex color table | <p><b>User Defined:</b> By selecting <b>Edit Color</b> → <b>Table Edit</b> access the color table to manipulate plot color values.</p>  |
| XY Shadow          | <p><b>Boolean:</b> Show XY shadow? Choose Hide or Show.<br/>Default = <b>Hide</b></p>  |
| YZ Shadow          | <p><b>Boolean:</b> Show YZ shadow? Choose Hide or Show.<br/>Default = <b>Hide</b></p>  |
| XZ Shadow          | <p><b>Boolean:</b> Show XZ shadow? Choose Hide or Show.<br/>Default = <b>Hide</b></p>  |

*Table D-44: Plot 3D Properties*

| Property          | Control Type: Values   |
|-------------------|--|
| Color             | <b>Color:</b> Color for the plot line. Click to choose from the default color palette, or specify RGB values. Default = [0, 0, 0] (black)  |
| Line style        | <b>Line Style:</b> Style for the plot line. Select a style from the list. Default =  (solid line)   |
| Thickness         | <b>Line Thickness:</b> Thickness for the plot line. Select a thickness from the list. Default = 1  |
| Shading           | <b>String List:</b> Shading method. Select a method from the list. Choose between these values: <ul style="list-style-type: none"> <li>• <b>Flat:</b> Flat shading</li> <li>• <b>Gouraud:</b> Gouraud shading</li> </ul> Default = <b>Flat</b> |
| Symbol            | <b>Symbol:</b> Symbol to appear at regular intervals on the plot line. Choose a symbol from the list. Default = <b>No symbol</b>   |
| Symbol size       | <b>Number:</b> Factor from 0 - 1 determining the size of the selected symbol. Move slider to change the size. Default = 0.2  |
| Use default color | <b>Boolean:</b> Activate Symbol color property. Choose <b>True</b> or <b>False</b> . Default = <b>False</b>  |
| Symbol color      | <b>Color:</b> Color for the selected symbol. Click to choose from the default color palette, or specify RGB values. Default = [0, 0, 0] (black)  |
| Symbol thickness  | <b>Number:</b> Line thickness from 1 - 9.9 for the selected symbol. Move slider to change the thickness. Default = 1.  |
| Symbol increment  | <b>Number:</b> Interval at which symbols will be displayed on the plot line. Influenced by Number of points to average (above). Edit to change the value. Default = 1  |

Table D-44: Plot 3D Properties (Continued)

# Surface

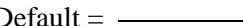
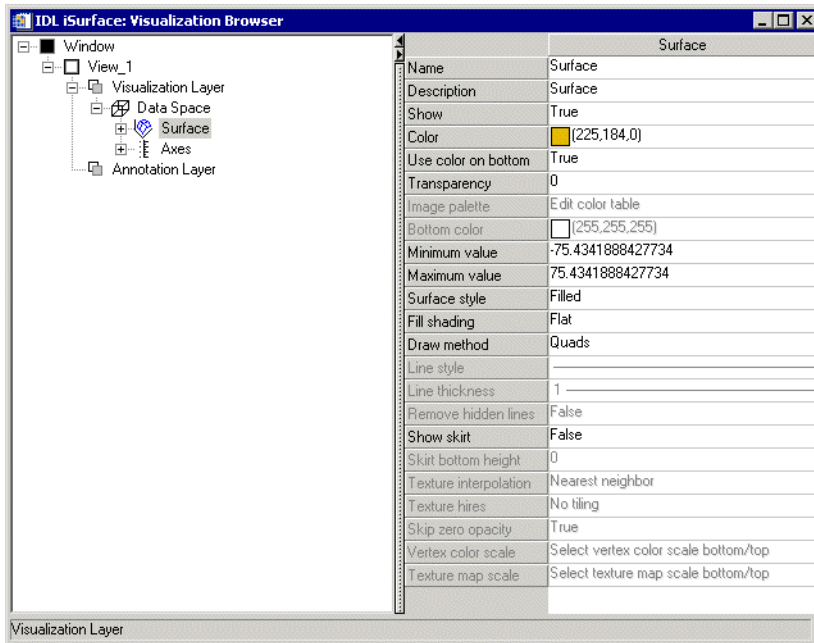

Figure D-23: Visualization Browser with Surface Properties Displayed

These properties control surface object visualizations. For each property, the type of control and the values that can be assigned are listed. For a description of how a particular control is used, refer to [Appendix B, “Property Controls”](#).

| Property | Control Type: Values  |
|----------|---|
| Color    | <b>Color:</b> Color of the surface visualization. Click to choose from the default color palette, or specify RGB values. Default = [255, 184, 0] (gold) |

Table D-45: Surface Properties

| Property            | Control Type: Values   |
|---------------------|--|
| Use color on bottom | <p><b>Boolean:</b> Display a color for the bottom of the surface. Choose <b>True</b> or <b>False</b>.</p> <p>Default = <b>False</b></p>  |
| Image palette       | <p><b>User Defined:</b> By selecting <b>Edit Color</b> → <b>Table Edit</b> access the color table to manipulate surface color values.</p>  |
| Bottom color        | <p><b>Color:</b> Color to be used for the bottom of the surface. Click to choose from the default color palette, or specify RGB values.</p> <p>Default = [255, 255, 255] (white)</p>   |
| Minimum value       | <p><b>Number:</b> Minimum Z-Axis value of the surface plot. Edit the number to change the value.</p>   |
| Maximum value       | <p><b>Number:</b> Maximum Z-Axis value of the surface plot. Edit the number to change the value.</p>   |
| Surface style       | <p><b>String List:</b> Style used for rendering the surface. Select a style from the list. Choose from these values:</p> <ul style="list-style-type: none"> <li>• <b>Points:</b> Data points in the surface are rendered as points.</li> <li>• <b>Wire mesh:</b> Data points in the surface are connected with lines, forming a mesh.</li> <li>• <b>Filled:</b> Data points in the surface are connected with filled quadrangles or triangles, forming a solid surface.</li> <li>• <b>Ruled XZ:</b> Data points in the surface are connected with horizontal (Z-direction) lines, forming a grid.</li> <li>• <b>Ruled YZ:</b> Data points in the surface are connected with vertical (Y-direction) lines, forming a grid.</li> <li>• <b>Lego:</b> Stacked histogram-style plot in which each data value is rendered as an outline box covering the XY extent of the cell and with a height proportional to the Z value.</li> <li>• <b>Lego filled:</b> Same as Lego, but the boxes are filled.</li> </ul> <p>Default = <b>Filled</b></p> |

Table D-45: Surface Properties (Continued)

| Property            | Control Type: Values   |
|---------------------|--|
| Fill shading        | <p><b>String List:</b> Method used for shading the surface polygons. Select a shading method from the list. Choose from these values:</p> <ul style="list-style-type: none"> <li>• <b>Flat:</b> Shades polygons with a uniform fill.</li> <li>• <b>Gouraud:</b> Interpolates intensities from each vertex along each edge. Then, when the polygons are converted, interpolates the shading along each scan line from the edge intensities. Results in a more natural appearance.</li> </ul> <p>Default = <b>Flat</b></p> |
| Draw method         | <p><b>String List:</b> Method used for drawing the surface. Select a method from the list. Choose from these values:</p> <ul style="list-style-type: none"> <li>• <b>Quads:</b> Draw a surface composed of quadrangles.</li> <li>• <b>Triangles:</b> Draw a surface composed of triangles.</li> </ul> <p>Default = <b>Quads</b></p>  |
| Line style          | <p><b>Line Style:</b> Style of lines used for constructing the surface. Select a style from the list. Default = _____ (solid line)</p>   |
| Line thickness      | <p><b>Line Thickness:</b> Thickness of lines used for constructing the surface. Select a thickness from the list. Default = 1</p>  |
| Remove hidden lines | <p><b>Boolean:</b> Hide lines that show through the surface mesh or grid. Choose <b>True</b> or <b>False</b>.</p> <p>Default = <b>False</b></p>  |
| Show skirt          | <p><b>Boolean:</b> Display the edges of the surface as a filled skirt? Choose <b>True</b> or <b>False</b>.</p> <p>Default = <b>False</b></p>   |
| Skirt bottom height | <p><b>Number:</b> Set bottom of displayed skirt to this height. Edit the number to change the value.</p> <p>Default = 0</p>  |

Table D-45: Surface Properties (Continued)

| Property              | Control Type: Values   |
|-----------------------|--|
| Texture interpolation | <p><b>String List:</b> Method used for interpolating selected texture map. Select a method from the list. Choose from these values:</p> <ul style="list-style-type: none"> <li>• <b>Nearest Neighbor:</b> Assign the value of the nearest pixel to the pixel in the output image. Fastest method, but may cause jagged edges.</li> <li>• <b>Bilinear:</b> Create a weighted average based on the nearness and brightness of the closest four pixels, and assign that value to the pixel in the output image.</li> </ul> <p>Default = <b>Nearest Neighbor</b></p> |
| Texture hires         | <p><b>String List:</b> Method used for tiling the selected high-resolution texture map. Select a tiling method from the list. Choose from these values:</p> <ul style="list-style-type: none"> <li>• <b>No tiling:</b> Do not use tiling</li> <li>• <b>LOD tiling:</b> Use level of detail tiling</li> <li>• <b>Tiling:</b> Use tiling</li> </ul> <p>Default = <b>No tiling</b></p>  |
| Skip zero opacity     | <p><b>Boolean:</b> Skip zero opacity for surface? Choose <b>True</b> or <b>False</b>.</p> <p>Default = <b>True</b></p>   |
| Vertex Color Scale    | <p><b>User Defined:</b> Select vertex color scale bottom/top.</p>  |
| Texture Map Scale     | <p><b>User Defined:</b> Select texture map scale bottom/top.</p>   |

Table D-45: Surface Properties (Continued)

# Contour

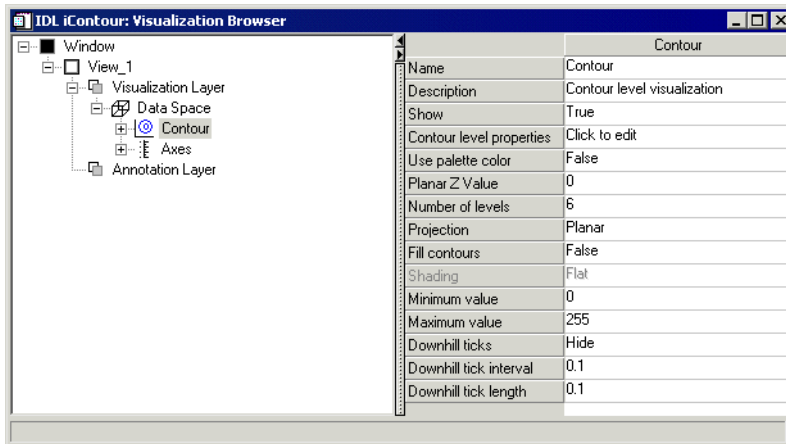

Figure D-24: Visualization Browser with Contour Properties Displayed

These properties control contour object visualizations. For each property, the type of control and the values that can be assigned are listed. For a description of how a particular control is used, refer to [Appendix B, “Property Controls”](#).

| Property                 | Control Type: Values   |
|--------------------------|--|
| Contour level properties | <b>User Defined:</b> Click to edit individual or all contour level properties. Click <input type="button" value="Edit..."/> to display the Contour Levels window. See “ <a href="#">Contour Levels Window</a> ” on page 434 for details. |
| Use palette color        | <b>Boolean:</b> Use palette color? Choose <b>True</b> or <b>False</b> . Default = <b>False</b>   |

Table D-46: Contour Properties



| Property               | Control Type: Values   |
|------------------------|--|
| Planar Z Value         | <p><b>Number:</b> Z value of plane on to which to project contours. Edit the number to change the value.</p> <p><b>Note</b> - If the Z value is zero, and the Projection is Planar, then the contour visualization is considered to be 2D. If the Z value is nonzero, then the contour visualization is considered to be 3D, and the dataspace associated with this contour will be automatically switched to 3D.</p> <p>Default = 0</p> |
| Number of levels       | <p><b>Number:</b> Number of contour levels to display. Edit the number to change the value. Default = 5</p>  |
| Projection             | <p><b>String List:</b> Method of projection. Select a method from the list. Choose from these values:</p> <ul style="list-style-type: none"> <li>• <b>Three-D:</b> Project in three dimensions</li> <li>• <b>Planar:</b> Project onto a plane</li> </ul> <p>Default = <b>Planar</b></p>  |
| Fill contours          | <p><b>Boolean:</b> Fill space between contours? Choose <b>True</b> or <b>False</b>. Default = <b>False</b></p>   |
| Shading                | <p><b>String List:</b> Shading method. Select a method from the list. Choose between these values:</p> <ul style="list-style-type: none"> <li>• <b>Flat:</b> Flat shading</li> <li>• <b>Gouraud:</b> Gouraud shading</li> </ul> <p>Default = <b>Flat</b></p>   |
| Minimum value          | <p><b>Number:</b> Minimum value to display in the contour. Edit number to change value. No default value.</p>  |
| Maximum value          | <p><b>Number:</b> Maximum value to display in the contour. Edit number to change value. No default value.</p>  |
| Downhill ticks         | <p><b>Boolean:</b> Show downhill ticks? Choose <b>Hide</b> or <b>Show</b>. Default = <b>Hide</b></p>   |
| Downhill tick interval | <p><b>Number:</b> Distance between downhill tick marks. Edit number to change value. Default = 0.2</p>   |

Table D-46: Contour Properties (Continued)

| Property             | Control Type: Values   |
|----------------------|--|
| Downhill tick length | <b>Number:</b> Length of downhill tick marks. Edit number to change value. Default = 0 . 2 |

Table D-46: Contour Properties (Continued)

## Contour Levels Window

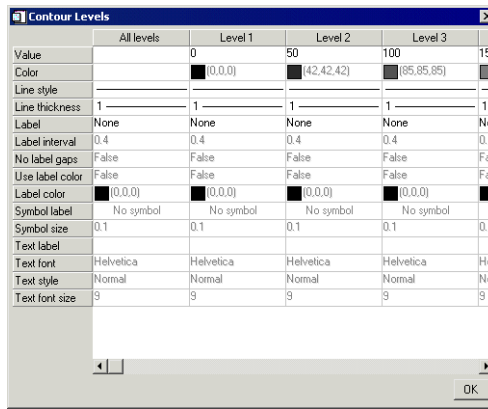

Figure D-25: Contour Levels Window

The Contour Levels window contains properties that control the contour levels.

| Property   | Control Type: Values  |
|------------|---|
| Value      | <b>Number:</b> Value of the contour level. Edit the number to change the value. Default comes from contour data.                                  |
| Color      | <b>Color:</b> Color for the contour level. Click to choose from the default color palette, or specify RGB values. Default = [ 0 , 0 , 0 ] (black) |
| Line style | <b>Line Style:</b> Style for the contour level. Select a style from the list. Default = _____ (solid line)  |

Table D-47: Contour Levels Properties

| Property         | Control Type: Values   |
|------------------|--|
| Line thickness   | <b>Line Thickness:</b> Thickness for the contour level. Select a thickness from the list. Default = 1  |
| Label            | <b>String List:</b> Choose the kind of label to use for each contour level. Choose from these values: <ul style="list-style-type: none"> <li>• <b>None</b></li> <li>• Value</li> <li>• Text</li> <li>• Symbol</li> </ul> |
| Label interval   | <b>Number:</b> Distance between labels on the contour level. Edit number to change value. Default = 0.4  |
| No label gaps    | <b>Boolean:</b> Interrupt the contour level for the label. Choose <b>True</b> or <b>False</b> . Default = <b>False</b>   |
| Use label color  | <b>Boolean:</b> Display a color for the contour level's label. Choose <b>True</b> or <b>False</b> . Default = <b>False</b>   |
| Label color      | <b>Color:</b> Color for the contour level label. Click to choose from the default color palette, or specify RGB values. Default = [0, 0, 0] (black)  |
| Symbol label     | <b>Symbol:</b> Symbol to appear at regular intervals on the contour level. Choose a symbol from the list. Default = <b>No symbol</b>   |
| Symbol size      | <b>Number:</b> Factor from 0 - 1 determining the size of the selected symbol. Move slider to change the size. Default = 0.2  |
| Text label       | <b>String:</b> Text that labels the contour object in the legend. Edit string to change value. Default = none  |
| Tick format code | <b>String:</b> Text that defines the tick format. Edit string to change format. You can edit this value only if <b>Tick Format</b> is set to <b>Use Tick Format Code</b> . Default = none                                |

Table D-47: Contour Levels Properties (Continued)

| Property       | Control Type: Values   |
|----------------|--|
| Tick format    | <p><b>String List:</b> Choose a format code or time interval to use for each tick interval. Choose from these values:</p> <ul style="list-style-type: none"> <li>• <b>None</b></li> <li>• <b>Use Tick Format Code</b></li> <li>• Filled Fixed Width Integer</li> <li>• Freeform Integer or Float</li> <li>• Float with 2 or 4 decimal places</li> <li>• Exponential with 2 or 4 decimal places</li> <li>• <b>Date (13 formats)</b></li> <li>• <b>Time (11 formats)</b></li> </ul> <p>Default = <b>None</b></p> |
| Text font      | <p><b>String List:</b> Font used for label text. Select a font from the list. Choose from these values:</p> <ul style="list-style-type: none"> <li>• <b>Helvetica</b></li> <li>• <b>Courier</b></li> <li>• <b>Times</b></li> <li>• <b>Symbol</b></li> <li>• <b>Hershey</b></li> </ul> <p>Default = <b>Helvetica</b></p>  |
| Text style     | <p><b>String List:</b> Style used for label text. Select a style from the list. Choose from these values:</p> <ul style="list-style-type: none"> <li>• <b>Normal</b></li> <li>• <b>Bold</b></li> <li>• <b>Italic</b></li> <li>• <b>Bold italic</b></li> </ul> <p>Default = <b>Normal</b></p>   |
| Text font size | <p><b>Number:</b> Font size in points for the label text. Edit the number to change the size. Default = 9</p>  |

Table D-47: Contour Levels Properties (Continued)

# Volume

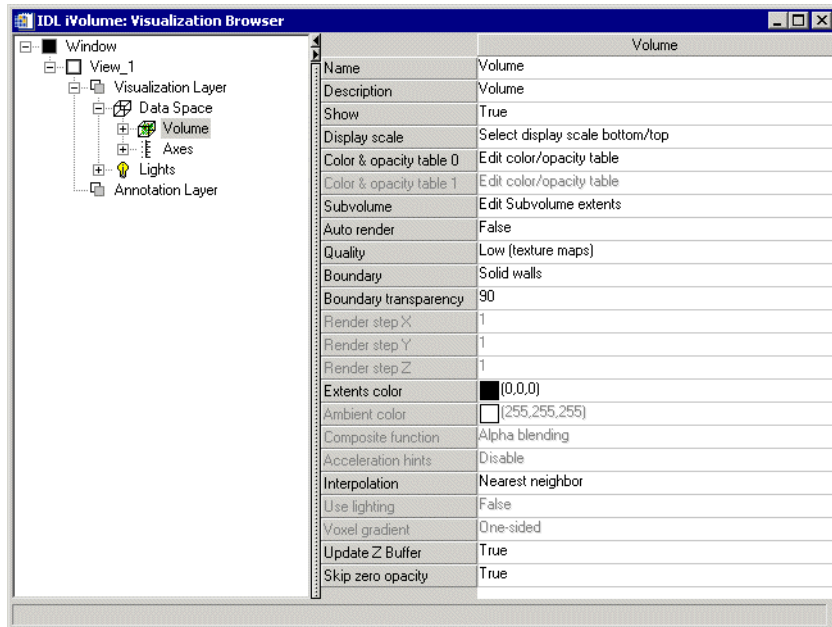

*Figure D-26: Visualization Browser with Volume Properties Displayed*

These properties control volume object visualizations. For each property, the type of control and the values that can be assigned are listed. For a description of how a particular control is used, refer to [Appendix B, “Property Controls”](#).

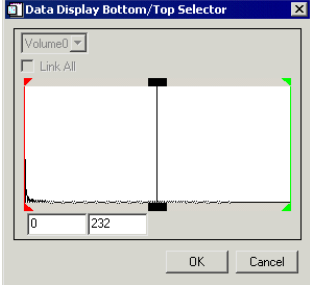
| Property      | Control Type: Values  |
|---------------|---|
| Display Scale | <p>Set the display scale for the selected volume.<br/> <b>Select Display Scale Bottom/Top → Edit</b></p>  |

*Table D-48: Volume Properties*

| Property                | Control Type: Values   |
|-------------------------|--|
| Color & Opacity Table 0 | <p><b>Color:</b> By selecting <b>Edit Color</b> → <b>Table Edit</b> access the color table to manipulate plot color values</p>  <p><b>Note -</b> To edit the opacity only in the editor, uncheck the <b>R</b>, <b>G</b>, and <b>B</b> boxes in both the <b>Modify</b> and <b>Display</b> rows. Edit the remaining line by clicking on and dragging the line in the window. Click <b>OK</b> when finished.</p> |
| Color & Opacity Table 1 | <p><b>Color:</b> By selecting <b>Edit Color</b> → <b>Table Edit</b> access the color table to manipulate plot color values.</p>  |

Table D-48: Volume Properties (Continued)

| Property    | Control Type: Values  |
|-------------|---|
| Subvolume   | <p><b>String:</b> Edit SubVolume Extents.</p>   |
| Auto render | <p><b>Boolean:</b> Automatically render the volume each time the window is redrawn? Choose <b>True</b> or <b>False</b>. Default = <b>False</b></p>  |
| Quality     | <p><b>String List:</b> Quality of the volume. Choose between these values:</p> <ul style="list-style-type: none"> <li>• <b>Low (texture maps)</b></li> <li>• <b>High (volume)</b></li> </ul> <p>Default = <b>Low</b></p>                          |
| Boundary    | <p><b>String List:</b> Boundary around the volume. Choose between these values:</p> <ul style="list-style-type: none"> <li>• <b>Off</b></li> <li>• <b>Wire frame</b></li> <li>• <b>Solid walls</b></li> </ul> <p>Default = <b>Solid walls</b></p> |

Table D-48: Volume Properties (Continued)

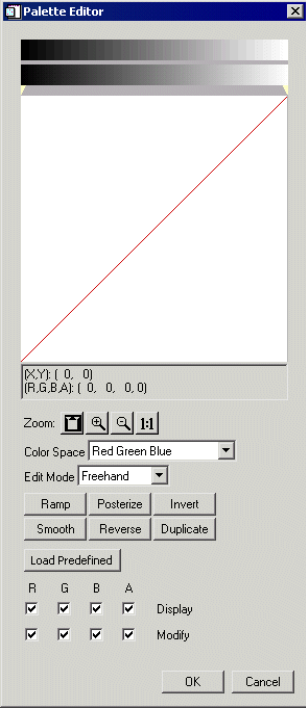

| Property              | Control Type: Values   |
|-----------------------|--|
| Boundary transparency | <p><b>Number:</b> Percent transparency of the boundary around the volume (wire frame or solid walls). Move slider to change value.</p> <p>Default = 90</p>   |
| Render step X         | <p><b>Number:</b> Stepping factor through the voxel matrix in the x direction.</p> <p>Default = 1</p>  |
| Render step Y         | <p><b>Number:</b> Stepping factor through the voxel matrix in the y direction.</p> <p>Default = 1</p>  |
| Render step Z         | <p><b>Number:</b> Stepping factor through the voxel matrix in the z direction.</p> <p>Default = 1</p>  |
| Extents color         | <p><b>Color:</b> Color for the volume. Click to choose from the default color palette, or specify RGB values.</p> <p>Default = [0, 0, 0] (black)</p>   |
| Ambient color         | <p><b>String:</b> Choose from default color palette or specify RGB values.</p> <p>Default = [255, 255, 255] (white)</p>  |
| Composite function    | <p><b>String:</b> Choose composite function.</p> <p>Default = <b>Alpha Blending</b></p>  |
| Acceleration hints    | <p><b>Boolean:</b> Use acceleration hints? Choose <b>Enable</b> or <b>Disable</b>.</p> <p>Default = <b>Disable</b></p>   |
| Interpolation         | <p><b>String List:</b> Set interpolation type. Choose between these values:</p> <ul style="list-style-type: none"> <li>• <b>Nearest neighbor</b></li> <li>• <b>Trilinear</b></li> </ul> <p>Default = <b>Nearest neighbor</b></p> |
| Use lighting          | <p><b>Boolean:</b> Use lighting? Choose <b>True</b> or <b>False</b>. Default = <b>False</b></p>  |

Table D-48: Volume Properties (Continued)

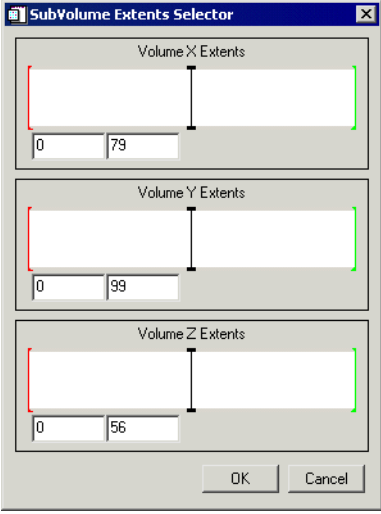
| Property          | Control Type: Values   |
|-------------------|--|
| Voxel gradient    | <b>Color:</b> Color of the volume. Click to choose from the default color palette, or specify RGB values.<br>Default = [0, 0, 0] (black) |
| Update Z Buffer   | <b>Boolean:</b> Update Z Buffer? Choose <b>True</b> or <b>False</b> .<br>Default = <b>True</b>   |
| Skip zero opacity | <b>Boolean:</b> Skip zero opacity? Choose <b>True</b> or <b>False</b> .<br>Default = <b>True</b>   |

*Table D-48: Volume Properties (Continued)*

## Isosurface

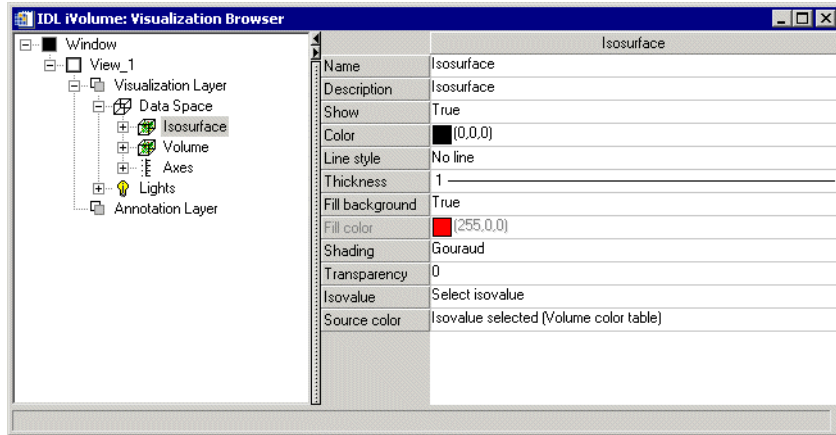

Figure D-27: Visualization Browser with Isosurface Properties Displayed

These properties control isosurface object visualizations. For each property, the type of control and the values that can be assigned are listed. For a description of how a particular control is used, refer to [Appendix B, “Property Controls”](#).

| Property  | Control Type: Values  |
|-----------|---|
| Color     | <p><b>Color:</b> Color to be used for the isosurface lines in this visualization. Click to choose from the default color palette, or specify RGB values.</p> <p>Default = [0, 0, 0] (black)</p> |
| Linestyle | <p><b>Line Style:</b> Style of the isosurface lines. Select a line style from the list.</p> <p>Default = No line</p>  |
| Thickness | <p><b>Line Thickness:</b> Thickness of the isosurface lines in points. Select a thickness from the list.</p> <p>Default = 1</p>   |

Table D-49: Isosurface Properties

| Property        | Control Type: Values   |
|-----------------|--|
| Fill background | <p><b>Boolean:</b> Fill background? Choose <b>True</b> or <b>False</b>.</p> <p>Default = <b>True</b></p>   |
| Fill color      | <p><b>Color:</b> Color to fill. Click to choose from the default color palette, or specify RGB values.</p> <p>Default = [255, 0, 0] (red)</p>  |
| Transparency    | <p><b>Number:</b> Level of transparency.</p> <p>Default = 0</p>  |
| Isovalue        | <p><b>String:</b> Edit isovalue.</p> <div data-bbox="655 597 1036 1031" data-label="Image"> </div>   |
| Source color    | <p><b>String List:</b> Choose from the following:</p> <ul style="list-style-type: none"> <li>• <b>Isovalue selected (Volume color table)</b></li> <li>• <b>User selected (Fill Color Property)</b></li> </ul> <p>Default = <b>Isovalue selected (Volume color table)</b></p> |

*Table D-49: Isosurface Properties*

## Interval Volume

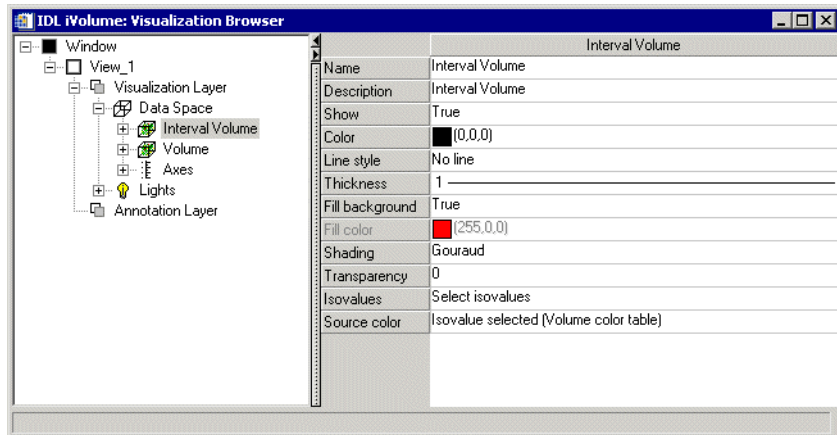
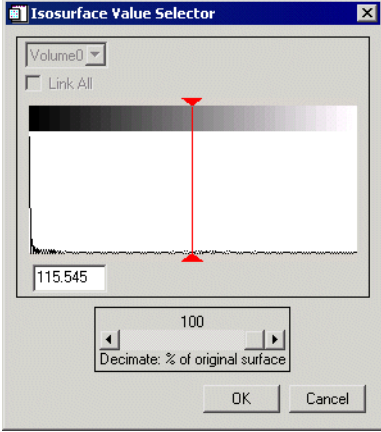

Figure D-28: Visualization Browser with Interval Volume Properties Displayed

These properties control interval volume object visualizations. For each property, the type of control and the values that can be assigned are listed. For a description of how a particular control is used, refer to [Appendix B, “Property Controls”](#).

| Property  | Control Type: Values   |
|-----------|--|
| Color     | <p><b>Color:</b> Color to be used for the interval volume lines in this visualization. Click to choose from the default color palette, or specify RGB values.</p> <p>Default = [ 0 , 0 , 0 ] (black)</p> |
| Linestyle | <p><b>Line Style:</b> Style of the interval volume lines. Select a line style from the list.</p> <p>Default = No line</p>  |
| Thickness | <p><b>Line Thickness:</b> Thickness of the interval volume lines in points. Select a thickness from the list.</p> <p>Default = 1</p>   |

Table D-50: Interval Volume Container Properties

| Property        | Control Type: Values   |
|-----------------|--|
| Fill background | <p><b>Boolean:</b> Fill background? Choose <b>True</b> or <b>False</b>.</p> <p>Default = <b>True</b></p>   |
| Fill color      | <p><b>Color:</b> Color to fill. Click to choose from the default color palette, or specify RGB values.</p> <p>Default = [255, 0, 0] (red)</p>  |
| Transparency    | <p><b>Number:</b> Level of transparency.</p> <p>Default = 0</p>  |
| Isovalues       | <p><b>String:</b> Edit isovalue.</p>    |
| Source Color    | <p><b>String List:</b> Set source color. Choose from the following:</p> <ul style="list-style-type: none"> <li>• <b>Isovalue selected (Volume color table)</b></li> <li>• <b>User selected (Fill Color Property)</b></li> </ul> <p>Default = <b>Isovalue selected (Volume color table)</b></p> |

*Table D-50: Interval Volume Container Properties*

## Image Plane

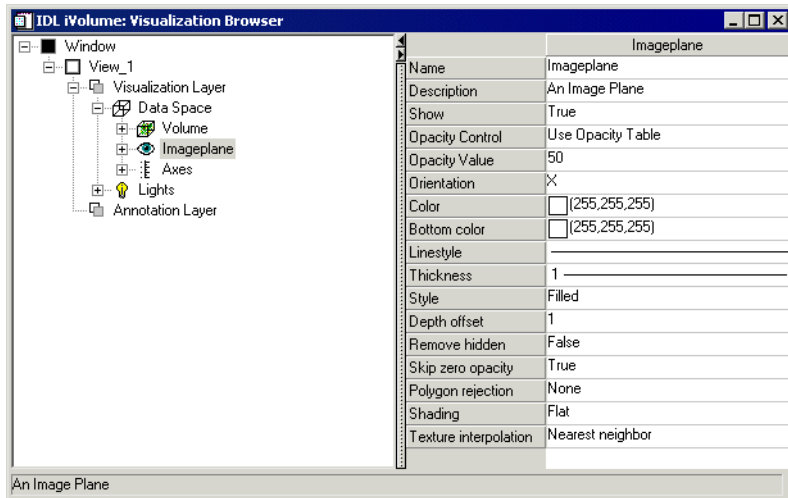

Figure D-29: Visualization Browser with Image Plane Properties Displayed

These properties control image plane object visualizations. For each property, the type of control and the values that can be assigned are listed. For a description of how a particular control is used, refer to [Appendix B, “Property Controls”](#).

| Property        | Control Type: Values   |
|-----------------|--|
| Opacity Control | <p><b>String List:</b> Set opacity. Choose from the following:</p> <ul style="list-style-type: none"> <li>• <b>Use Opacity Table</b></li> <li>• <b>Opaque</b></li> <li>• <b>Opacity Value</b></li> </ul> <p>Default = <b>Use Opacity Table</b></p> |
| Opacity Value   | <p><b>Number:</b> Factor from 0 - 100 determining the level of opacity. Move slider to change the size.</p> <p>Default = 50</p>  |

Table D-51: Image Plane Container Properties

| Property          | Control Type: Values   |
|-------------------|--|
| Orientation       | Set orientation.<br>Default = <b>X</b>   |
| Color             | <b>Color:</b> Color to be used for the image plane lines in this visualization. Click to choose from the default color palette, or specify RGB values.<br>Default = [255, 255, 255] (white)                    |
| Bottom color      | <b>Color:</b> Color to be used for the image plane bottom color in this visualization. Click to choose from the default color palette, or specify RGB values.<br>Default = [255, 255, 255] (white)             |
| Linestyle         | <b>Line Style:</b> Style of lines used for constructing the surface. Select a style from the list.<br>Default =  (solid line) |
| Thickness         | <b>Line Thickness:</b> Thickness of lines used for constructing the surface. Select a thickness from the list.<br>Default = 1  |
| Style             | <b>Style:</b> Style of lines used. Choose from the following: <ul style="list-style-type: none"> <li>• <b>Points</b></li> <li>• <b>Lines</b></li> <li>• <b>Filled</b></li> </ul> Default = <b>Filled</b>       |
| Depth offset      | <b>Number:</b> Set depth offset value. Enter value.<br>Default = 1   |
| Remove hidden     | <b>Boolean:</b> Remove hidden? Choose <b>True</b> or <b>False</b> .<br>Default = <b>False</b>  |
| Skip zero opacity | <b>Boolean:</b> Skip zero opacity? Choose <b>True</b> or <b>False</b> .<br>Default = <b>True</b>   |

Table D-51: Image Plane Container Properties



| Property              | Control Type: Values   |
|-----------------------|--|
| Polygon rejection     | <p><b>String List:</b> Hide polygons based on their orientation. Choose from the following:</p> <ul style="list-style-type: none"> <li>• <b>None</b></li> <li>• <b>Normals point away</b></li> <li>• <b>Normals point toward</b></li> </ul> <p>Default = <b>None</b></p> <p><b>Note</b> - Polygon rejection has no effect on non-filled polygons (where Style is <b>Points</b> or <b>Lines</b>).</p> |
| Shading               | <p><b>String List:</b> Shading method. Select a method from the list. Choose between these values:</p> <ul style="list-style-type: none"> <li>• <b>Flat:</b> Flat shading</li> <li>• <b>Gouraud:</b> Gouraud shading</li> </ul> <p>Default = <b>Flat</b></p>   |
| Texture interpolation | <p><b>String List:</b> Set texture interpolation type. Choose between these values:</p> <ul style="list-style-type: none"> <li>• <b>Nearest neighbor</b></li> <li>• <b>Bilinear</b></li> </ul> <p>Default = <b>Nearest neighbor</b></p>  |

*Table D-51: Image Plane Container Properties*

## Colorbar

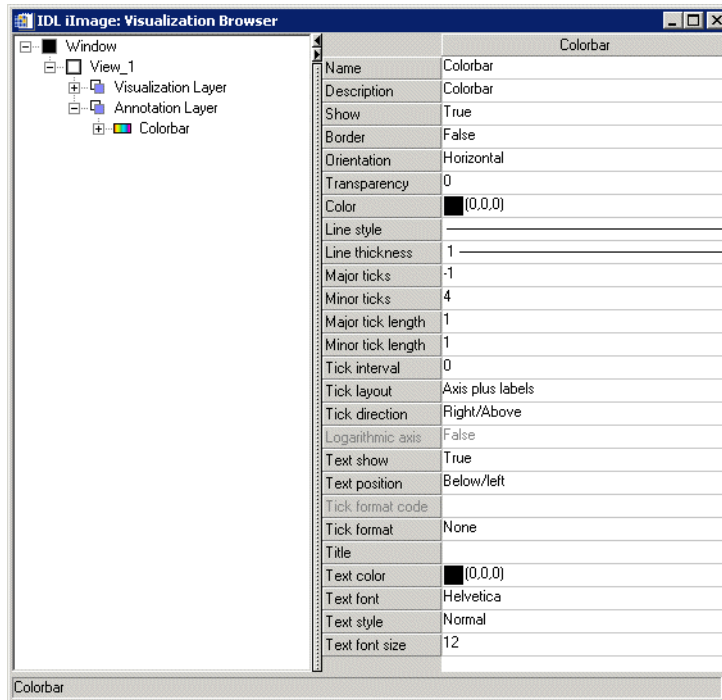

Figure D-30: Visualization Browser with Colorbar Properties Displayed

These properties control colorbar object visualizations. For each property, the type of control and the values that can be assigned are listed. For a description of how a particular control is used, refer to [Appendix B, “Property Controls”](#).

| Property | Control Type: Values   |
|----------|--|
| Border   | <b>Boolean:</b> Set border on or off. Choose <b>True</b> or <b>False</b> .<br>Default = <b>False</b> |

Table D-52: Colorbar Container Properties

| Property          | Control Type: Values   |
|-------------------|--|
| Orientation       | <p><b>Boolean:</b> Set orientation of colorbar. Choose <b>Horizontal</b> or <b>Vertical</b>.</p> <p>Default = <b>Horizontal</b></p>  |
| Color             | <p><b>Color:</b> Color to be used for the colorbar in this visualization. Click to choose from the default color palette, or specify RGB values. Default = [0, 0, 0] (black)</p>   |
| Line style        | <p><b>Line Style:</b> Style of the colorbar lines. Select a line style from the list. Default =  (solid line)</p>   |
| Line thickness    | <p><b>Line Thickness:</b> Thickness of the colorbar lines in points. Select a thickness from the list. Default = 1</p>   |
| Major ticks       | <p><b>Number:</b> Set number of major tick marks. Enter value.</p> <p>Default = 3</p>  |
| Minor ticks       | <p><b>Number:</b> Set number of minor tick marks. Enter value.</p> <p>Default = 0</p>  |
| Major tick length | <p><b>Number:</b> Factor from 0 - 1 determining major tick length. Move slider to change the size.</p> <p>Default = .05</p>  |
| Minor tick length | <p><b>Number:</b> Factor from 0 - 1 determining minor tick length. Move slider to change the size.</p> <p>Default = 1</p>  |
| Tick interval     | <p><b>Number:</b> Set tick interval. Enter value.</p> <p>Default = 0</p>   |
| Tick layout       | <p><b>String List:</b> Set tick layout type. Choose between these values:</p> <ul style="list-style-type: none"> <li>• <b>Axis plus labels</b></li> <li>• <b>Labels only</b></li> <li>• <b>Box style</b></li> </ul> <p>Default = <b>Axis plus labels</b></p> |

Table D-52: Colorbar Container Properties

| Property         | Control Type: Values   |
|------------------|--|
| Tick direction   | <p><b>String List:</b> Set tick direction. Choose between these values:</p> <ul style="list-style-type: none"> <li>• <b>Right/Above</b></li> <li>• <b>Left/Below</b></li> </ul> <p>Default = <b>Right/Above</b></p>  |
| Logarithmic axis | Default = <b>false</b>   |
| Text show        | <p><b>Boolean:</b> Set text to show or not show. Choose <b>True</b> or <b>False</b>.</p> <p>Default = <b>True</b> (show)</p>   |
| Text position    | <p><b>String List:</b> Set text position. Choose between these values:</p> <ul style="list-style-type: none"> <li>• <b>Below/left</b></li> <li>• <b>Above/right</b></li> </ul> <p>Default = <b>Below/left</b></p>  |
| Tick format code | Shows the code for the tick format selected. Default = empty   |
| Tick format      | <p><b>String List:</b> Choose a format code or time interval to use for each tick interval. Choose from these values:</p> <ul style="list-style-type: none"> <li>• <b>None</b></li> <li>• <b>Use Tick Format Code</b></li> <li>• Filled Fixed Width Integer</li> <li>• Freeform Integer or Float</li> <li>• Float with 2 or 4 decimal places</li> <li>• Exponential with 2 or 4 decimal places</li> <li>• <b>Date (13 formats)</b></li> <li>• <b>Time (11 formats)</b></li> </ul> <p>Default = <b>None</b></p> |
| Title            | <p>Title: Enter title for colorbar.</p> <p>Default = <b>RGB Table 0</b></p>  |
| Text color       | <p><b>Color:</b> Color to be used for the legend text. Click to choose from the default color palette, or specify RGB values. Default = [0, 0, 0] (black)</p>  |

Table D-52: Colorbar Container Properties

| Property       | Control Type: Values   |
|----------------|--|
| Text font      | <p><b>String List:</b> Font used for legend text. Select a font from the list. Choose from these values:</p> <ul style="list-style-type: none"> <li>• <b>Helvetica</b></li> <li>• <b>Courier</b></li> <li>• <b>Times</b></li> <li>• <b>Symbol</b></li> <li>• <b>Hershey</b></li> </ul> <p>Default = <b>Helvetica</b></p> |
| Text style     | <p><b>String List:</b> Style used for legend text. Select a style from the list. Choose from these values:</p> <ul style="list-style-type: none"> <li>• <b>Normal</b></li> <li>• <b>Bold</b></li> <li>• <b>Italic</b></li> <li>• <b>Bold italic</b></li> </ul> <p>Default = <b>Normal</b></p>                            |
| Text font size | <p><b>Number:</b> Font size in points for the legend text. Edit the number to change the size. Default = 12</p>  |

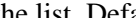
*Table D-52: Colorbar Container Properties*

# Histogram

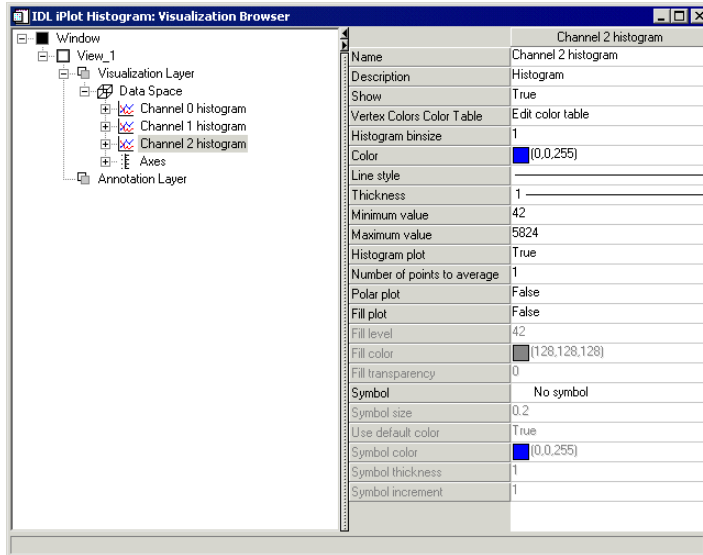

Figure D-31: Visualization Browser with Histogram Properties Displayed

These properties control histogram object visualizations. For each property, the type of control and the values that can be assigned are listed. For a description of how a particular control is used, refer to [Appendix B, “Property Controls”](#).

| Property                     | Control Type: Values   |
|------------------------------|--|
| Vertex Colors<br>Color Table | <p><b>Color:</b> By selecting <b>Edit Color</b> → <b>Table Edit</b> access the color table to manipulate plot color values</p>  |
| Histogram binsize            | <p><b>Number:</b> Set histogram binsize.<br/>Default = 1</p>   |
| Color                        | <p><b>Color:</b> Color to be used for the plot lines. RGB values are assigned or you may edit your color.<br/>Default = <b>varies</b></p>  |

Table D-53: Histogram Container Properties

| Property                    | Control Type: Values  |
|-----------------------------|---|
| Line style                  | <p><b>Line Style:</b> Style of the colorbar lines. Select a line style from the list.</p> <p>Default =  (solid line)</p> |
| Thickness                   | <p><b>Line Thickness:</b> Thickness of the colorbar lines in points. Select a thickness from the list.</p> <p>Default = 1</p>   |
| Minimum value               | <p><b>Number:</b> Minimum histogram value. Enter a number.</p> <p>Default = <b>varies</b></p>   |
| Maximum value               | <p><b>Number:</b> Maximum histogram value. Enter a number.</p> <p>Default = <b>varies</b></p>   |
| Histogram plot              | <p><b>Boolean:</b> Set histogram to show or not show. Choose <b>True</b> or <b>False</b>.</p> <p>Default = <b>True</b> (show)</p>   |
| Number of points to average | <p><b>Number:</b> Number of points in plot to be averaged. Enter a number.</p> <p>Default = 1</p>   |
| Polar plot                  | <p><b>Boolean:</b> Set histogram to show or not show as a polar plot. Choose <b>True</b> or <b>False</b>.</p> <p>Default = <b>False</b> (hide)</p>  |
| Fill plot                   | <p><b>Boolean:</b> Set histogram to show or not show as a filled plot. Choose <b>True</b> or <b>False</b>.</p> <p>Default = <b>False</b> (hide)</p>   |
| Fill level                  | <p><b>Number:</b> Level to fill if fill plot is selected. Enter a number.</p> <p>Default = <b>varies</b></p>  |
| Fill color                  | <p><b>Color:</b> Color to be used for fill plot if selected.</p> <p>Default = [128, 128, 128] (grey)</p>  |

Table D-53: Histogram Container Properties

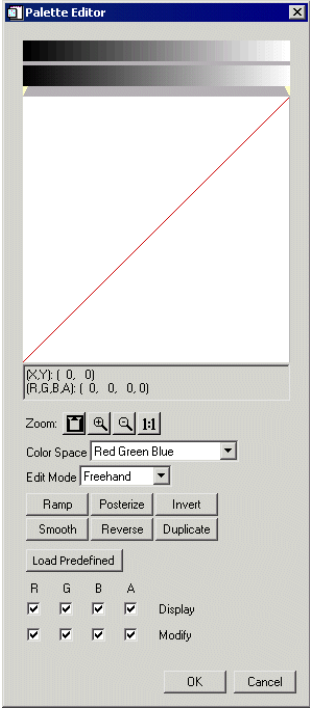

| Property          | Control Type: Values  |
|-------------------|---|
| Fill transparency | <p><b>Number:</b> Value of transparency if fill plot is selected. Enter a number.</p> <p>Default = 0</p>  |
| Symbol            | <p><b>String List:</b> Font used for legend text. Select a font from the list. Choose from the list of symbols.</p> <p>Default = <b>No symbol</b></p> |
| Symbol size       | <p><b>Number:</b> Value for symbol size in points if fill symbol is selected. Enter a number.</p> <p>Default = 0.2</p>                                |
| Use default color | <p><b>Boolean:</b> Set to use default color for symbols. Choose <b>True</b> or <b>False</b>.</p> <p>Default = <b>True</b> (use default color)</p>     |
| Symbol color      | <p><b>Color:</b> Color to be used for symbols if default color is set to False. Enter a value.</p> <p>Default = <b>varies</b></p>                     |
| Symbol thickness  | <p><b>Number:</b> Value for symbol thickness in points if symbol is selected. Enter a number.</p> <p>Default = 1</p>                                  |
| Symbol increment  | <p><b>Number:</b> Value for symbol increments if fill symbol is selected. Enter a number.</p> <p>Default = 1</p>                                      |

*Table D-53: Histogram Container Properties*

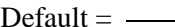
# Axes

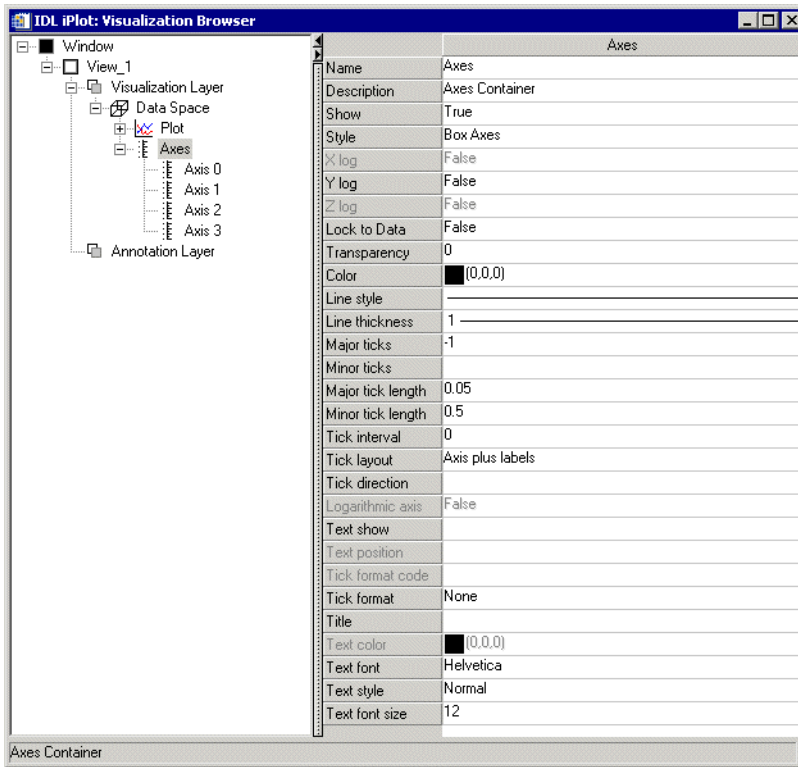
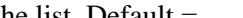

Figure D-32: Visualization Browser with Axis Properties Displayed

These properties control axis object visualizations. For each property, the type of control and the values that can be assigned are listed. For a description of how a particular control is used, refer to [Appendix B, “Property Controls”](#).

The following table contains the properties that control the container for the visualization axes.

| Property       | Control Type: Values  |
|----------------|---|
| Style          | <p><b>String List:</b> Select display style for axes. Choose from these values:</p> <ul style="list-style-type: none"> <li>• <b>None:</b> Do not display axes.</li> <li>• <b>At Dataspace Minimum:</b> Display 2 axes for 2-D visualization, 3 axes for 3-D visualization.</li> <li>• <b>Box Axes:</b> Display 4 axes for 2-D visualization, 12 axes for 3-D visualization.</li> <li>• <b>Crosshairs:</b> Display crosshair style axes.</li> </ul> <p>Default = <b>At Dataspace Minimum</b></p> |
| Lock to Data   | <p><b>Boolean:</b> Locks axis (axes) to data.</p> <p>Default = <b>False</b></p>   |
| Transparency   | <p><b>Number:</b> Adjusts transparency of axis (axes).</p> <p>Default = 0</p>   |
| Color          | <p><b>Color:</b> Color to be used for the axis lines in this visualization. Click to choose from the default color palette, or specify RGB values. Default = [0, 0, 0] (black)</p>  |
| Line style     | <p><b>Line Style:</b> Style of the axis tick lines. Select a line style from the list. Default =  (solid line)</p>   |
| Line thickness | <p><b>Line Thickness:</b> Thickness of the axis tick lines. Select a thickness from the list. Default = 1</p>   |
| Major ticks    | <p><b>Number:</b> Set number of major tick marks. Enter value.</p> <p>Default = 0</p>   |
| Minor ticks    | <p><b>Number:</b> Set number of minor tick marks. Enter value.</p> <p>Default = 0</p>   |

*Table D-54: Axes Container Properties*

| Property          | Control Type: Values  |
|-------------------|---|
| Major Tick Length | <b>Number:</b> Normalized length of major tick marks for all axes from 0 (no ticks) to 1 (major tick marks span the visualization). Move the slider to change the value. Default = 0.05.  |
| Minor tick length | <b>Number:</b> Relative length of minor tick marks for all axes from -1 (minor tick marks extend the length of major tick marks on left side of axes) to 1 (minor tick marks extend same length as major tick marks on right side of axes). Move the slider to change the value. Default = 0.5 (minor tick marks extend one-half the length of major tick marks on right side of axes).   |
| Tick interval     | <b>Number:</b> Interval between ticks. Edit the number to change the value. Default = 0   |
| Tick layout       | <b>String List:</b> Select layout style for major and minor tick visualization on all axes. Choose from these values: <ul style="list-style-type: none"> <li>• <b>Axis plus labels:</b> Display tick labels and marks.</li> <li>• <b>Labels only:</b> Display tick labels only (no tick marks).</li> <li>• <b>Box style:</b> Display tick labels and marks, with labels enclosed in boxes.</li> </ul> Default = <b>Axis plus labels</b> |
| Tick direction    | <b>String List:</b> Select a direction for tick marks. Choose from these values: <ul style="list-style-type: none"> <li>• <b>Right/Above:</b> Place tick marks to the right of or above the axis line.</li> <li>• <b>Left/Below:</b> Place text to the left of or below the axis line.</li> </ul> Default = <b>Right/Above</b>  |
| Text show         | <b>Boolean:</b> Set text to show or not show. Choose <b>True</b> or <b>False</b> .<br>Default = <b>True</b> (show)  |

Table D-54: Axes Container Properties

| Property      | Control Type: Values   |
|---------------|--|
| Text position | <p><b>String List:</b> Select a position for tick and label text. Choose from these values:</p> <ul style="list-style-type: none"> <li>• <b>Below/left:</b> Place text below or to the left of the axis line.</li> <li>• <b>Above/right:</b> Place text above or to the right of the axis line.</li> </ul> <p>Default = <b>Below/left</b></p>  |
| Tick format   | <p><b>String List:</b> Choose a format code or time interval to use for each tick interval. Choose from these values:</p> <ul style="list-style-type: none"> <li>• <b>None</b></li> <li>• <b>Use Tick Format Code</b></li> <li>• Filled Fixed Width Integer</li> <li>• Freeform Integer or Float</li> <li>• Float with 2 or 4 decimal places</li> <li>• Exponential with 2 or 4 decimal places</li> <li>• <b>Date (13 formats)</b></li> <li>• <b>Time (11 formats)</b></li> </ul> <p>Default = <b>None</b></p> |
| Title         | <p><b>String:</b> Title to apply to all axes for this visualization. Enter title text for the axes. No default value.</p>  |
| Text color    | <p><b>Color:</b> Color to be used for the text. Click to choose from the default color palette, or specify RGB values.</p> <p>Default = [0, 0, 0] (black)</p>  |

*Table D-54: Axes Container Properties*

| Property       | Control Type: Values   |
|----------------|--|
| Text font      | <p><b>String List:</b> Font used for tick and label text. Select a font from the list. Choose from these values:</p> <ul style="list-style-type: none"> <li>• <b>Helvetica</b></li> <li>• <b>Courier</b></li> <li>• <b>Times</b></li> <li>• <b>Symbol</b></li> <li>• <b>Hershey</b></li> </ul> <p>Default = <b>Helvetica</b></p> |
| Text style     | <p><b>String List:</b> Style used for tick and label text. Select a style from the list. Choose from these values:</p> <ul style="list-style-type: none"> <li>• <b>Normal</b></li> <li>• <b>Bold</b></li> <li>• <b>Italic</b></li> <li>• <b>Bold italic</b></li> </ul> <p>Default = <b>Normal</b></p>                            |
| Text font size | <p><b>Number:</b> Font size in points for the tick and label text. Edit the number to change the size. Default = 12</p>  |

*Table D-54: Axes Container Properties*

This table contains the properties that control axis visualization X, Y, or (for three-dimensional visualizations) Z. For each property, the type of control and the values that can be assigned are listed. For a description of how a particular control is used, refer to [Appendix B, “Property Controls”](#).

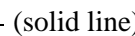
| Property   | Control Type: Values   |
|------------|--|
| Color      | <p><b>Color:</b> Color to be used for the axis line. Click to choose from the default color palette, or specify RGB values. Default = [0, 0, 0] (black)</p>  |
| Line style | <p><b>Line Style:</b> Style of the axis tick lines. Select a line style from the list. Default =  (solid line)</p> |

*Table D-55: Property Settings for Individual Axes*

| Property          | Control Type: Values  |
|-------------------|---|
| Line thickness    | <b>Line Thickness:</b> Thickness of the axis tick lines in points. Select a thickness from the list. Default = 1  |
| Major ticks       | <b>Number:</b> Number of major ticks marks to display along the axis. Edit the number to change the value. Default = 5  |
| Minor ticks       | <b>Number:</b> Number of minor ticks to display between major ticks. Edit the number to change the value. Default = 3   |
| Major tick length | <b>Number:</b> Normalized length of major tick marks for this axis from 0 (no ticks) to 1 (major tick marks span the visualization). Move the slider to change the value. Default = 0.05  |
| Minor tick length | <b>Number:</b> Relative length of minor tick marks for this axis from -1 (minor tick marks extend the length of major tick marks on left side of axis) to 1 (minor tick marks extend same length as major tick marks on right side of axis). Move the slider to change the value. Default = 0.5 (Minor tick marks extend one-half the length of major tick marks on right side of axis).  |
| Tick interval     | <b>Number:</b> Interval between major tick marks. Edit the number to change the value. Default = 0 (use the default interval for the specified range)   |
| Tick layout       | <p><b>String List:</b> Select layout style for major and minor tick visualization. Choose from these values:</p> <ul style="list-style-type: none"> <li>• <b>Axis plus labels:</b> Display tick labels and marks.</li> <li>• <b>Labels only:</b> Display tick labels only (no tick marks).</li> <li>• <b>Box style:</b> Display tick labels and marks, with labels enclosed in boxes.</li> </ul> <p>Default = <b>Axis plus labels</b></p> |

Table D-55: Property Settings for Individual Axes (Continued)

| Property       | Control Type: Values  |
|----------------|---|
| Tick direction | <p><b>String List:</b> Select a direction for tick marks. Choose from these values:</p> <ul style="list-style-type: none"> <li>• <b>Right/Above:</b> Place tick marks to the right of or above the axis line.</li> <li>• <b>Left/Below:</b> Place text to the left of or below the axis line.</li> </ul> <p>Default = <b>Right/Above</b></p>  |
| Text show      | <p><b>Boolean:</b> Show tick and label text? Choose <b>True</b> or <b>False</b>.<br/>Default = <b>True</b>.</p>   |
| Text position  | <p><b>String List:</b> Select a position for tick and label text. Choose from these values:</p> <ul style="list-style-type: none"> <li>• <b>Below/left:</b> Place text below or to the left of the axis line.</li> <li>• <b>Above/right:</b> Place text above or to the right of the axis line.</li> </ul> <p>Default = <b>Below/left</b></p>   |
| Tick format    | <p><b>String List:</b> Choose a format code or time interval to use for each tick interval. Choose from these:</p> <ul style="list-style-type: none"> <li>• <b>None</b></li> <li>• <b>Use Tick Format Code</b></li> <li>• Filled Fixed Width Integer</li> <li>• Freeform Integer or Float</li> <li>• Float with 2 or 4 decimal places</li> <li>• Exponential with 2 or 4 decimal places</li> <li>• <b>Date (13 formats)</b></li> <li>• <b>Time (11 formats)</b></li> </ul> <p>Default = <b>None</b></p> |
| Title          | <p><b>String:</b> Title to apply to this axis. Enter title text for the axes. No default value.</p>   |
| Text color     | <p><b>Color:</b> Color to be used for the text. Click to choose from the default color palette, or specify RGB values. Default = [0, 0, 0] (black)</p>  |

Table D-55: Property Settings for Individual Axes (Continued)



| Property       | Control Type: Values   |
|----------------|--|
| Text font      | <p><b>String List:</b> Font used for tick and label text. Select a font from the list. Choose from these values:</p> <ul style="list-style-type: none"> <li>• <b>Helvetica</b></li> <li>• <b>Courier</b></li> <li>• <b>Times</b></li> <li>• <b>Symbol</b></li> <li>• <b>Hershey</b></li> </ul> <p>Default = <b>Helvetica</b></p> |
| Text style     | <p><b>String List:</b> Style used for tick and label text. Select a style from the list. Choose from these values:</p> <ul style="list-style-type: none"> <li>• <b>Normal</b></li> <li>• <b>Bold</b></li> <li>• <b>Italic</b></li> <li>• <b>Bold italic</b></li> </ul> <p>Default = <b>Normal</b></p>                            |
| Text font size | <p><b>Number:</b> Font size in points for the tick and label text. Edit the number to change the size. Default = 12</p>  |

*Table D-55: Property Settings for Individual Axes (Continued)*

# Lights

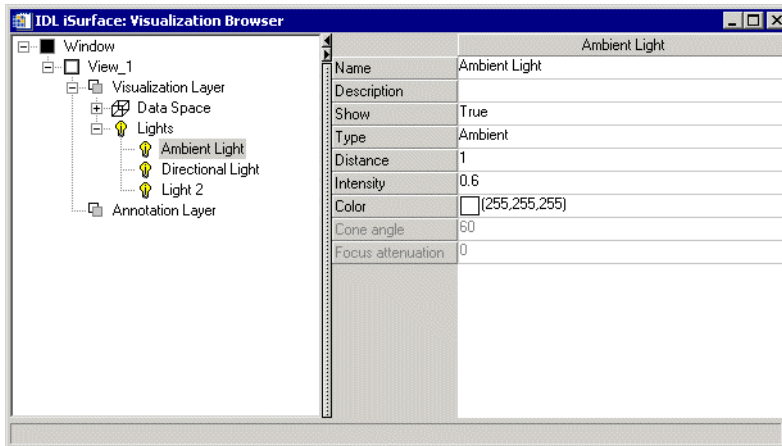

*Figure D-33: Visualization Browser with Light Properties Displayed*

Lights properties control the lighting of the data space. These properties are available only for 3-D Surface and Volume visualizations.

Three types of lights can be configured through the Lights properties: Ambient Light, Light 1 (from above), and Light 2 (from below). Each type of light has the same set of properties, as described in [Table D-56](#).

For each property, the type of control and the values that can be assigned are listed. For a description of how a particular control is used, refer to [Appendix B, “Property Controls”](#).

| Property  | Control Type: Values  |
|-----------|---|
| Type      | <p><b>String List:</b> Type of light source for this light. Select a type of light from the list. Choose from these options:</p> <ul style="list-style-type: none"> <li>• <b>Ambient:</b> Universal light source with no direction or position. An ambient light illuminates every surface in the scene equally, which means that no edges are made visible by contrast. Ambient light controls the overall brightness and color of the scene.</li> <li>• <b>Positional:</b> Supplies divergent light rays so that the edges of surfaces can be made visible by contrast. A positional light source can be located anywhere in the scene.</li> <li>• <b>Directional:</b> Supplies parallel light rays from a light source located at an infinite distance from scene.</li> <li>• <b>Spotlight:</b> Illuminates only a specific area defined by the light's position, direction, and the <i>cone angle</i> (angle the spotlight covers).</li> </ul> <p>Default = <b>Positional</b></p> |
| Distance  | <p><b>Number:</b> Distance of the light source from the visualization from -1 (in front of the visualization) to 1 (behind the visualization). Move the slider to change the value.<br/>Default = <b>-1</b> for Ambient Light and Light 1, <b>1</b> for Light 2</p>   |
| Intensity | <p><b>Number:</b> Intensity of this light from 0 (no light) to 1 (bright light). Move the slider to change the value. Default = <b>0.5</b> for Ambient Light, <b>0.8</b> for Light 1 and Light 2</p>  |
| Color     | <p><b>Color:</b> Color of this light. Click to choose from the default color palette, or specify RGB values.<br/>Default = [255, 255, 255] (white)</p>  |

Table D-56: Property Settings for Lights

| Property          | Control Type: Values  |
|-------------------|---|
| Cone angle        | <p><b>Number:</b> Angle the spotlight covers from 0° to 180°. Active only when <b>Spotlight</b> type is selected. Move the slider to change the value.</p> <p>Default = <b>60</b></p>   |
| Focus attenuation | <p><b>Number:</b> Floating-point value from 0 to 128 that attenuates the intensity of spotlights as the distance from the center of the cone of coverage increases. This factor is used as an exponent to the cosine of the angle between the direction of the spotlight and the direction from the light to the vertex being lighted. Active only when <b>Spotlight</b> type is selected. Move the slider to change the value.</p> <p>Default = <b>0</b></p> |

*Table D-56: Property Settings for Lights (Continued)*

## Polygonal ROI

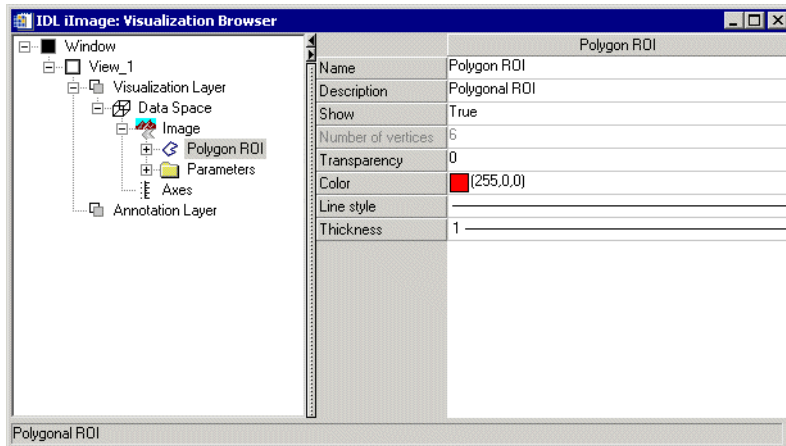

Figure D-34: Visualization Browser with Polygon ROI Properties Displayed

These properties control polygonal ROI object visualizations. For each property, the type of control and the values that can be assigned are listed. For a description of how a particular control is used, refer to [Appendix B, “Property Controls”](#)

| Property        | Control Type: Values   |
|-----------------|--|
| Color           | <b>Color:</b> Color to be used for the line. Click to choose from the default color palette, or specify RGB values. Default = [0, 0, 0] (black)  |
| Linestyle       | <b>Line Style:</b> Style of the polygon lines. Select a line style from the list. Default =  (solid line) |
| Thickness       | <b>Line Thickness:</b> Thickness of the polygon lines in points. Select a thickness from the list. Default = 1   |
| Fill background | <b>Boolean:</b> Fill background? Choose <b>True</b> or <b>False</b> . Default = <b>True</b>  |

Table D-57: Property Settings for Polygonal ROI

| Property     | Control Type: Values   |
|--------------|--|
| Fill color   | <b>Color:</b> Color to fill. Click to choose from the default color palette, or specify RGB values.<br>Default = [255, 255, 255] (white) |
| Transparency | <b>Number:</b> Level of transparency.<br>Default = 0   |

*Table D-57: Property Settings for Polygonal ROI*

## IDL Graphics Objects

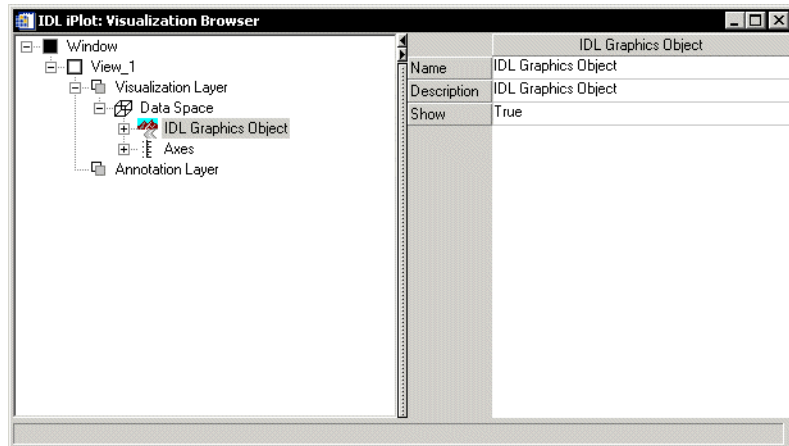

*Figure D-35: Visualization Browser with IDL Graphics Object Properties Displayed*

You can import an IDL graphics object into an iTool and display it directly by selecting the “IDL Graphics Object” visualization type. The properties available will depend on the type of graphics object. See the properties listing for the specific graphics object in the *IDL Reference Guide* for details.

---

### Note

The behavior of IDL graphics objects imported into an iTool may not be the same as that of the corresponding iTool visualization. While importing an existing graphics object into an iTool will often work, you will generally obtain better results using an iTool visualization type.

---



---

### Tip

In order to display properties for a generic IDL graphics object in the iTool property sheet interface, the graphics object must have been created with the `REGISTER_PROPERTIES` keyword set. If no properties are registered, only the three standard iTool properties (Name, Description, and Show) will be present, as displayed in the previous figure.

---

# Map Grid

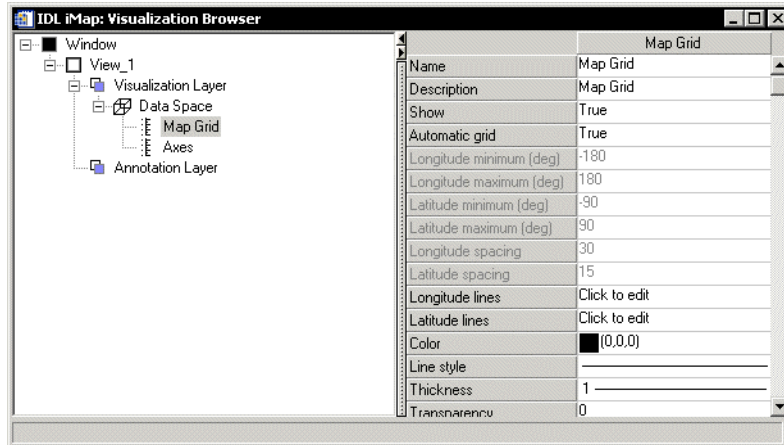

*Figure D-36: Visualization Browser with Map Grid Object Properties Displayed*

These properties control map grid object visualizations. For each property, the type of control and the values that can be assigned are listed. For a description of how a particular control is used, refer to [Appendix B, “Property Controls”](#).

| Name                    | Description   |
|-------------------------|---|
| Automatic grid          | <b>Boolean:</b> Automatically compute the grid range and spacing. Choose <b>True</b> or <b>False</b> . Default = <b>True</b><br><b>Note</b> - If a SAVE file is restored from an IDL version prior to 6.2, this property is set to <b>False</b> . |
| Longitude minimum (deg) | <b>Number:</b> Minimum longitude, in degrees, to include in the grid  |
| Longitude maximum (deg) | <b>Number:</b> Maximum longitude, in degrees, to include in the grid  |

*Table D-58: Property Settings for Map Grid*



| Name                   | Description   |
|------------------------|---|
| Latitude minimum (deg) | <b>Number:</b> Minimum latitude, in degrees, to include in the grid   |
| Latitude maximum (deg) | <b>Number:</b> Maximum latitude, in degrees, to include in the grid   |
| Longitude spacing      | <b>Number:</b> Longitude grid spacing, in degrees   |
| Latitude spacing       | <b>Number:</b> Latitude grid spacing, in degrees  |
| Longitude lines        | <p><b>User Defined:</b> Click to edit individual or all longitude line properties. Click  and <b>Edit...</b> to display the Map Grid Lines dialog.</p>  |

Table D-58: Property Settings for Map Grid

| Name            | Description   |
|-----------------|---|
| Latitude lines  | <p><b>User Defined:</b> Click to edit individual or all latitude line properties. Click  and <b>Edit...</b> to display the Map Grid Lines dialog.</p>  |
| Color           | <p><b>Color:</b> Color for the grid lines. Click to choose from the default color palette, or specify RGB values. Default = [0, 0, 0] (black)</p>   |
| Thickness       | <p><b>Line Thickness:</b> Thickness for the grid lines. Select a thickness from the list. Default = 1</p>   |
| Transparency    | <p><b>Number:</b> Transparency of the grid lines from 0% to 100%. Move the slider to change the value. Default = 0</p>  |
| Label           | <p><b>Boolean:</b> Use labels on the grid lines. Choose <b>True</b> or <b>False</b>. Default = <b>True</b></p>  |
| Label position  | <p><b>Number:</b> Normalized label position. Default = 0.5</p>  |
| Use label color | <p><b>Boolean:</b> Use default color instead of Label color. Choose <b>True</b> or <b>False</b>. Default = <b>False</b></p>   |
| Label color     | <p><b>Color:</b> Color for the grid label. Click to choose from the default color palette, or specify RGB values. Default = [0, 0, 0] (black)</p>   |

Table D-58: Property Settings for Map Grid

| Name                  | Description   |
|-----------------------|---|
| Label fill background | <p><b>String List:</b> Choose the kind of fill background for the label. Choose from these values:</p> <ul style="list-style-type: none"> <li>• <b>None</b></li> <li>• View color</li> <li>• Fill color</li> </ul>  |
| Label fill color      | <p><b>Color:</b> Color for the label background's fill. Click to choose from the default color palette, or specify RGB values. Default = [255, 255, 255] (white)</p>  |
| Text font             | <p><b>String List:</b> Font used for label text. Select a font from the list. Choose from these values:</p> <ul style="list-style-type: none"> <li>• <b>Helvetica</b></li> <li>• <b>Courier</b></li> <li>• <b>Times</b></li> <li>• <b>Symbol</b></li> <li>• <b>Hershey</b></li> </ul> <p>Default = <b>Helvetica</b></p> |
| Text style            | <p><b>String List:</b> Style used for label text. Select a style from the list. Choose from these values:</p> <ul style="list-style-type: none"> <li>• <b>Normal</b></li> <li>• <b>Bold</b></li> <li>• <b>Italic</b></li> <li>• <b>Bold italic</b></li> </ul> <p>Default = <b>Normal</b></p>                            |
| Text font size        | <p><b>Number:</b> Font size in points for the label text. Edit the number to change the size. Default = 12</p>  |

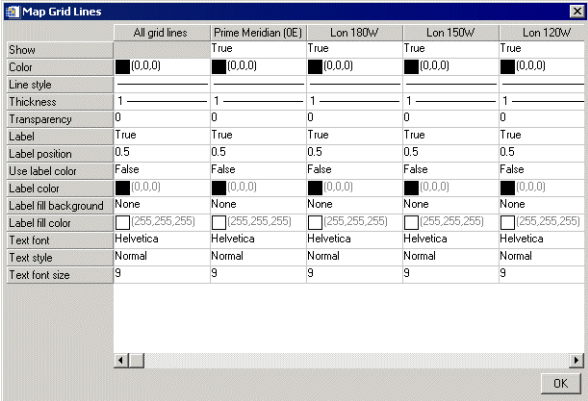
*Table D-58: Property Settings for Map Grid*

The Map Grid Lines dialog displays a property sheet for the longitude or latitude lines, depending on which set you want to edit. This sheet includes the same properties as the overall Map Grid object, from Color to Text font size.

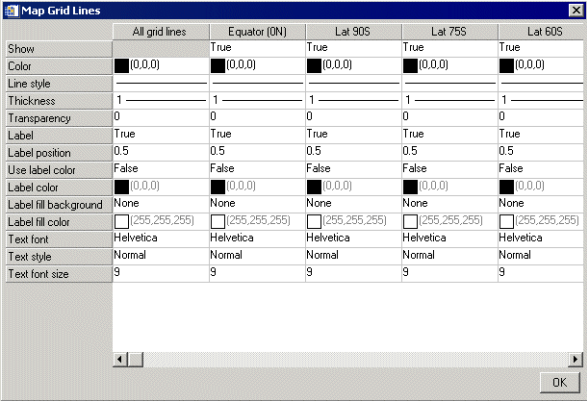
## ShapePolygon

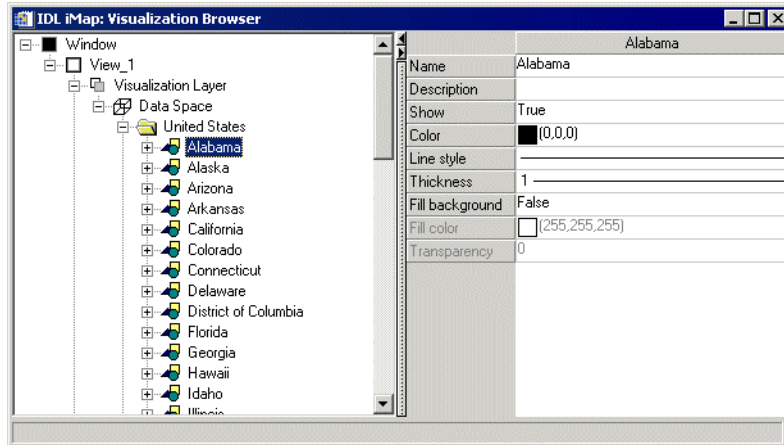

Figure D-37: Visualization Browser with ShapePolygon Properties Displayed

These properties control ShapePolygon visualizations. For each property, the type of control and the values that can be assigned are listed. For a description of how a particular control is used, refer to [Appendix B, “Property Controls”](#).

| Name            | Description   |
|-----------------|---|
| Color           | <b>Color:</b> Color for the ShapePolygon line. Click to choose from the default color palette, or specify RGB values. Default = [ 0 , 0 , 0 ] (black) |
| Line style      | <b>Line Style:</b> Style for the ShapePolygon line. Select a style from the list. Default = _____ (solid line)  |
| Thickness       | <b>Line Thickness:</b> Thickness for the ShapePolygon line. Select a thickness from the list. Default = 1   |
| Fill background | <b>Boolean:</b> Fill background? Choose <b>True</b> or <b>False</b> . Default = <b>False</b>  |

Table D-59: Property Settings for ShapePolygon

| Name         | Description   |
|--------------|---|
| Fill color   | <b>Color:</b> Color for the ShapePolygon fill. Click to choose from the default color palette, or specify RGB values. Default = [255, 255, 255] (white) |
| Transparency | <b>Number:</b> Transparency of the ShapePolygon fill from 0% to 100%. Move the slider to change the value. Default = 0                                  |

*Table D-59: Property Settings for ShapePolygon*

## ShapePolyline

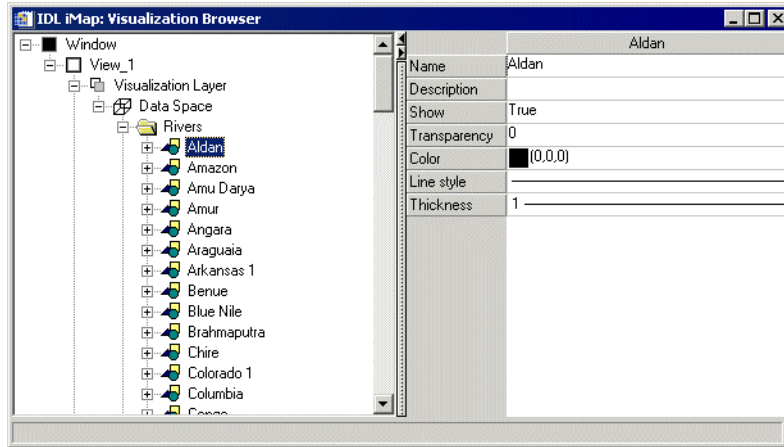

Figure D-38: Visualization Browser with ShapePolyline Properties Displayed

These properties control ShapePolyline visualizations. For each property, the type of control and the values that can be assigned are listed. For a description of how a particular control is used, refer to [Appendix B, “Property Controls”](#).

| Name         | Description   |
|--------------|---|
| Transparency | <b>Number:</b> Transparency of the ShapePolyline from 0% to 100%. Move the slider to change the value. Default = 0                            |
| Color        | <b>Color:</b> Color for the ShapePolyline. Click to choose from the default color palette, or specify RGB values. Default = [0, 0, 0] (black) |
| Line style   | <b>Line Style:</b> Style for the ShapePolyline. Select a style from the list. Default = _____ (solid line)                                    |
| Thickness    | <b>Line Thickness:</b> Thickness for the ShapePolyline. Select a thickness from the list. Default = 1   |

Table D-60: Property Settings for ShapePolyline

## ShapePoint

These properties control ShapePoint visualizations. For each property, the type of control and the values that can be assigned are listed. For a description of how a particular control is used, refer to [Appendix B, “Property Controls”](#).

| Name             | Description   |
|------------------|---|
| Symbol           | <b>Symbol:</b> Symbol to represent each ShapePoint. Choose a symbol from the list. Default = <b>No symbol</b>                                   |
| Symbol size      | <b>Number:</b> Factor from 0 to 1 determining the size of the selected symbol. Move slider to change the size. Default = 0.2                    |
| Symbol color     | <b>Color:</b> Color for the selected symbol. Click to choose from the default color palette, or specify RGB values. Default = [0, 0, 0] (black) |
| Symbol thickness | <b>Number:</b> Symbol thickness from 1 to 9.9 for the selected symbol. Move slider to change the thickness. Default = 1.                        |
| Transparency     | <b>Number:</b> Transparency of the ShapePoint fill from 0% to 100%. Move the slider to change the value. Default = 0                            |

*Table D-61: Property Settings for ShapePoint*

## 2D Annotation Layer Properties

The Annotation layer appears in the Visualization browser.

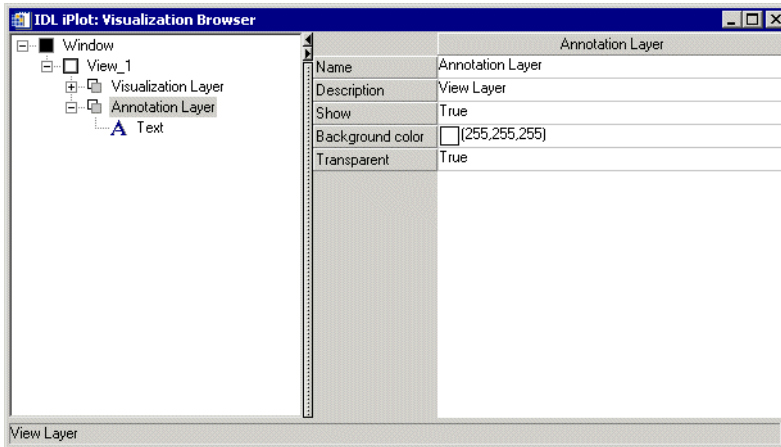

Figure D-39: Visualization Browser with Annotation Properties Displayed

The following types of annotations can be added to iTool visualizations: Text, Line, Line Profile, Rectangle, Oval, Polygon, and Freehand annotations. The following table contains properties that control the Annotation layer. Subsequent tables describe the properties specific to each type of annotation.

| Property         | Control Type: Values  |
|------------------|---|
| Background color | <p><b>Color:</b> Color to be used for the Annotation Layer background. For background to display, Transparent property must be set to <b>False</b>. Click to choose from the default color palette, or specify RGB values.</p> <p>Default = [255, 255, 255] (white)</p> |
| Transparent      | <p><b>Boolean:</b> Make the annotation layer transparent? Choose <b>True</b> or <b>False</b>.</p> <p>Default = <b>True</b></p>  |

Table D-62: Annotation Layer Properties



## Text Annotation Properties

These properties control text annotation visualizations. For each property, the type of control and the values that can be assigned are listed. For a description of how a particular control is used, refer to [Appendix B, “Property Controls”](#).

| Property             | Control Type: Values  |
|----------------------|---|
| Text string          | <p><b>String:</b> Text that appears in the annotation. Edit to change the text, or to add formatting commands such as the following:</p> <ul style="list-style-type: none"> <li>• <b>!C:</b> Add new line.</li> <li>• <b>!U:</b> Add superscript characters.</li> <li>• <b>!D:</b> Add subscript characters.</li> <li>• <b>!N:</b> Return to normal characters.</li> </ul> <p>For a complete list of embedded text formatting commands, refer to “<a href="#">Embedded Formatting Commands</a>” in Appendix H of the <i>IDL Reference Guide</i> manual. No default value.</p> |
| Horizontal alignment | <p><b>String List:</b> Horizontal alignment of multiple lines within text box. Choose from these values:</p> <ul style="list-style-type: none"> <li>• <b>Left:</b> Align text along the left border of the text box.</li> <li>• <b>Center:</b> Align text in the center of the text box.</li> <li>• <b>Right:</b> Align text along the right border of the text box.</li> </ul> <p>Default = <b>Left</b></p>  |
| Color                | <p><b>Color:</b> Color to be used for the text. Click to choose from the default color palette, or specify RGB values.</p> <p>Default = [0, 0, 0] (black)</p>   |
| Fill background      | <p><b>Boolean:</b> Fill the background of the text with the background color? Choose <b>True</b> or <b>False</b>.</p> <p>Default = <b>False</b></p>   |
| Transparency         | <p><b>Number:</b> Transparency of the text annotation from 0% to 100%. Move the slider to change the value.</p> <p>Default = 0</p>  |

Table D-63: Text Annotation Properties

| Property       | Control Type: Values   |
|----------------|--|
| Text font      | <p><b>String List:</b> Font used for text annotation. Select a font from the list. Choose from these values:</p> <ul style="list-style-type: none"> <li>• <b>Helvetica</b></li> <li>• <b>Courier</b></li> <li>• <b>Times</b></li> <li>• <b>Symbol</b></li> <li>• <b>Hershey</b></li> </ul> <p>Default = <b>Helvetica</b></p> |
| Text style     | <p><b>String List:</b> Style used for text annotation. Select a style from the list. Choose from these values:</p> <ul style="list-style-type: none"> <li>• <b>Normal</b></li> <li>• <b>Bold</b></li> <li>• <b>Italic</b></li> <li>• <b>Bold italic</b></li> </ul> <p>Default = <b>Normal</b></p>                            |
| Text font size | <p><b>Number:</b> Font size in points for the text annotation. Edit the number to change the size. Default = 12</p>  |

*Table D-63: Text Annotation Properties (Continued)*

## Line Annotation Properties

These properties control line annotation visualizations. For each property, the type of control and the values that can be assigned are listed. For a description of how a particular control is used, refer to [Appendix B, “Property Controls”](#).

| Property       | Control Type: Values   |
|----------------|--|
| Color          | <b>Color:</b> Color to be used for the line. Click to choose from the default color palette, or specify RGB values. Default = [0, 0, 0] (black)  |
| Linestyle      | <b>Line Style:</b> Style of the line annotation. Select a line style from the list. Default = ————— (solid line)   |
| Thickness      | <b>Line Thickness:</b> Thickness of the line annotation in points. Select a thickness from the list. Default = 1   |
| Arrow style    | Arrow Style Selector: Select an arrow style from the list. Choose from these values: <div style="text-align: center; margin: 10px 0;">  </div> Default = ..... (no arrow) |
| Arrowhead size | <b>Number:</b> Size of arrowhead in normalized units. Arrow style must be selected for arrowhead to display. Move the slider to change the value. Default = 0.05   |

Table D-64: Line Annotation Properties

## Line Profile Annotation Properties

These properties control line profile annotation visualizations. For each property, the type of control and the values that can be assigned are listed. For a description of how a particular control is used, refer to [Appendix B, “Property Controls”](#).

| Property                     | Control Type: Values  |
|------------------------------|---|
| Vertex Colors<br>Color Table | <p><b>User Defined:</b> By selecting <b>Edit Color</b> → <b>Table Edit</b> access the color table to manipulate plot color values</p>  |
| Color                        | <p><b>Color:</b> Color to be used for the line. Click to choose from the default color palette, or specify RGB values. Default = [0, 0, 0] (black)</p>  |
| Line style                   | <p><b>Line Style:</b> Style of the line profile annotation. Select a line style from the list. Default = ————— (solid line)</p>   |

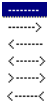
Table D-65: Line Profile Annotation Properties

| Property                    | Control Type: Values   |
|-----------------------------|--|
| Thickness                   | <b>Line Thickness:</b> Thickness of the line profile annotation in points. Select a thickness from the list. Default = 1   |
| Minimum value               | <b>Number:</b> Minimum value for line profile. Edit number to change value. No default value.  |
| Maximum value               | <b>Number:</b> Maximum value for line profile. Edit number to change value. No default value.  |
| Histogram plot              | <b>Boolean:</b> Show line profile as a histogram plot? Choose <b>True</b> or <b>False</b> .<br>Default = <b>False</b>  |
| Number of points to average | <b>Number:</b> Set number of points to average. Enter a value.<br>Default = 1  |
| Polar plot                  | <b>Boolean:</b> Show line profile as a polar plot? Choose <b>True</b> or <b>False</b> .<br>Default = <b>False</b>  |
| Fill plot                   | <b>Boolean:</b> Fill plot? Choose <b>True</b> or <b>False</b> .<br>Default = <b>False</b>  |
| Fill level                  | <b>Number:</b> Set level to fill. Enter value.<br>Default = 71   |
| Fill color                  | <b>Color:</b> Color used for fill. For color to display, Fill Plot property must be set to <b>True</b> . Click to choose from the default color palette, or specify RGB values.<br>Default = [255, 255, 255] (white) |
| Fill transparency           | <b>Number:</b> Transparency of the plot fill from 0% to 100%. Move the slider to change the value. Default = 0   |
| Symbol                      | <b>Symbol:</b> Symbol to appear at regular intervals on the plot line. Choose a symbol from the list. Default = <b>No symbol</b>   |
| Symbol size                 | <b>Number:</b> Factor from 0 - 1 determining the size of the selected symbol. Move slider to change the size. Default = 0.2  |

Table D-65: Line Profile Annotation Properties

| Property          | Control Type: Values  |
|-------------------|---|
| Use default color | <b>Boolean:</b> Activate Symbol color property. Choose <b>True</b> or <b>False</b> . Default = <b>False</b>   |
| Symbol color      | <b>Color:</b> Color for the selected symbol. Click to choose from the default color palette, or specify RGB values. Default = [0, 0, 0] (black)                       |
| Symbol thickness  | <b>Number:</b> Line thickness from 1 - 9.9 for the selected symbol. Move slider to change the thickness. Default = 1.   |
| Symbol increment  | <b>Number:</b> Interval at which symbols will be displayed on the plot line. Influenced by Number of points to average (above). Edit to change the value. Default = 1 |

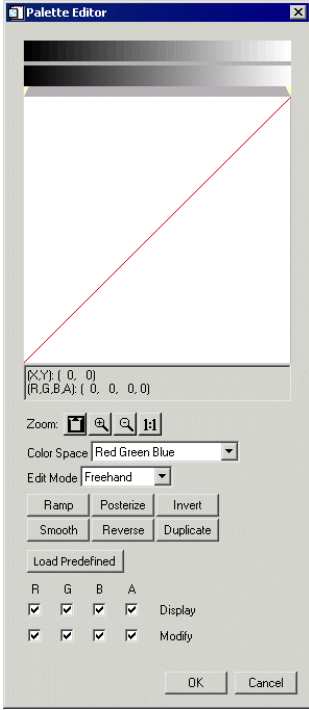
*Table D-65: Line Profile Annotation Properties*

## Rectangle Annotation Properties

These properties control rectangle annotation visualizations. For each property, the type of control and the values that can be assigned are listed. For a description of how a particular control is used, refer to [Appendix B, “Property Controls”](#).

| Property        | Control Type: Values  |
|-----------------|---|
| Color           | <b>Color:</b> Color to be used for the rectangle outline. Click to choose from the default color palette, or specify RGB values.<br>Default = [0, 0, 0] (black)   |
| Linestyle       | <b>Line Style:</b> Style of the rectangle outline. Select a line style from the list.<br>Default = ————— (solid line)   |
| Thickness       | <b>Line Thickness:</b> Thickness of the rectangle outline in points. Select a thickness from the list.<br>Default = 1   |
| Fill background | <b>Boolean:</b> Fill rectangle background? Choose <b>True</b> or <b>False</b> .<br>Default = <b>True</b>  |
| Fill color      | <b>Color:</b> Color to be used for the background. For background color to display, Fill Background property must be set to <b>True</b> . Click to choose from the default color palette, or specify RGB values.<br>Default = [255, 255, 255] (white) |
| Transparency    | <b>Number:</b> Transparency of the rectangle background fill from 0% to 100%. Move the slider to change the value. Default = 0  |

*Table D-66: Rectangle Annotation Properties*

## Oval Annotation Properties

These properties control oval annotation visualizations. For each property, the type of control and the values that can be assigned are listed. For a description of how a particular control is used, refer to [Appendix B, “Property Controls”](#).

| Property        | Control Type: Values   |
|-----------------|--|
| Color           | <b>Color:</b> Color to be used for the oval outline. Click to choose from the default color palette, or specify RGB values. Default = [0, 0, 0] (black)  |
| Linestyle       | <b>Line Style:</b> Style of the oval outline. Select a line style from the list. Default =  (solid line)  |
| Thickness       | <b>Line Thickness:</b> Thickness of the oval outline in points. Select a thickness from the list. Default = 1  |
| Fill background | <b>Boolean:</b> Fill oval background? Choose <b>True</b> or <b>False</b> . Default = <b>True</b>   |
| Fill color      | <b>Color:</b> Color to be used for the background. For background color to display, Fill Background property must be set to <b>True</b> . Click to choose from the default color palette, or specify RGB values. Default = [255, 255, 255] (white) |
| Transparency    | <b>Number:</b> Transparency of the oval background fill from 0% to 100%. Move the slider to change the value. Default = 0  |

Table D-67: Oval Annotation Properties



## Polygon Annotation Properties

These properties control polygon annotation visualizations. For each property, the type of control and the values that can be assigned are listed. For a description of how a particular control is used, refer to [Appendix B, “Property Controls”](#).

| Property        | Control Type: Values   |
|-----------------|--|
| Color           | <b>Color:</b> Color to be used for the polygon outline. Click to choose from the default color palette, or specify RGB values. Default = [0, 0, 0] (black)   |
| Linestyle       | <b>Line Style:</b> Style of the polygon outline. Select a line style from the list. Default = ————— (solid line)   |
| Thickness       | <b>Line Thickness:</b> Thickness of the polygon outline in points. Select a thickness from the list. Default = 1   |
| Fill background | <b>Boolean:</b> Fill polygon background? Choose <b>True</b> or <b>False</b> . Default = <b>True</b>  |
| Fill color      | <b>Color:</b> Color to be used for the background. For background color to display, Fill Background property must be set to <b>True</b> . Click to choose from the default color palette, or specify RGB values. Default = [255, 255, 255] (white) |
| Transparency    | <b>Number:</b> Transparency of the polygon background fill from 0% to 100%. Move the slider to change the value. Default = 0   |

Table D-68: Polygon Annotation Properties

## Freehand Annotation Properties

These properties control freehand annotation visualizations. For each property, the type of control and the values that can be assigned are listed. For a description of how a particular control is used, refer to [Appendix B, “Property Controls”](#).

| Property        | Control Type: Values   |
|-----------------|--|
| Color           | <b>Color:</b> Color to be used for the freehand shape outline. Click to choose from the default color palette, or specify RGB values. Default = [0, 0, 0] (black)  |
| Linestyle       | <b>Line Style:</b> Style of the freehand shape outline. Select a line style from the list. Default = ————— (solid line)  |
| Thickness       | <b>Line Thickness:</b> Thickness of the freehand shape outline in points. Select a thickness from the list. Default = 1  |
| Fill background | <b>Boolean:</b> Fill freehand shape background. Choose <b>True</b> or <b>False</b> . Default = <b>True</b>   |
| Fill color      | <b>Color:</b> Color to be used for the background. For background color to display, Fill Background property must be set to <b>True</b> . Click to choose from the default color palette, or specify RGB values. Default = [255, 255, 255] (white) |
| Transparency    | <b>Number:</b> Transparency of the freehand background fill from 0% to 100%. Move the slider to change the value. Default = 0  |

*Table D-69: Freehand Annotation Properties*

# Legend Properties

These properties control legend annotations. For each property, the type of control and the values that can be assigned are listed. For a description of how a particular control is used, refer to [Appendix B, “Property Controls”](#).

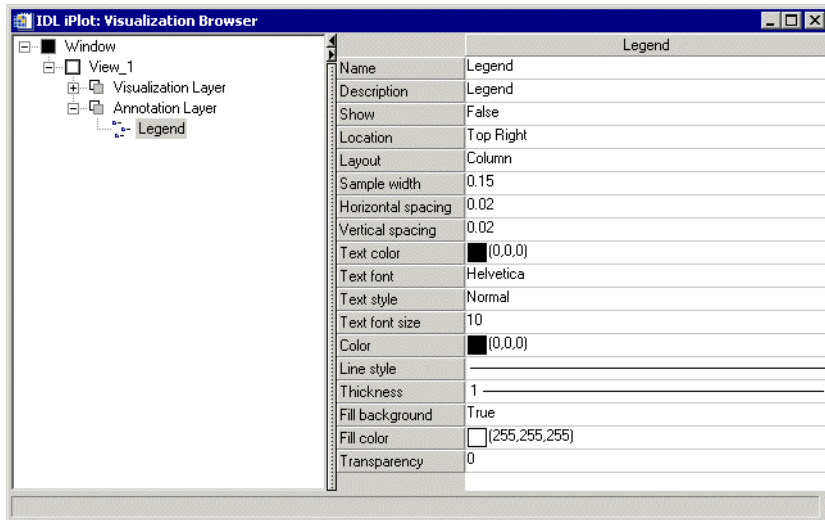

*Figure D-40: Visualization Browser with Legend Properties Displayed*

## Note

This section discusses the properties of the legend container, which can contain multiple legend items of different types. The individual legend types are described in:

“[Legend Contour Items](#)” on page 495

“[Legend Contour Level Items](#)” on page 496

“[Legend Plot Items](#)” on page 498

“[Legend Surface Items](#)” on page 499

| Property           | Control Type: Values   |
|--------------------|--|
| Location           | <p><b>String List:</b> Position of the legend within the iTool window. Select a location from the list. Choose from these values:</p> <ul style="list-style-type: none"> <li>• <b>Top Right</b></li> <li>• <b>User Specified</b></li> <li>• <b>Top Left</b></li> <li>• <b>Top Center</b></li> <li>• <b>Bottom Left</b></li> <li>• <b>Bottom Center</b></li> <li>• <b>Bottom Right</b></li> </ul> <p>Default = <b>Top Right</b></p> |
| Layout             | <p><b>String List:</b> Arrange the legend elements in columns or rows. Select a layout from the list. Choose from these values:</p> <ul style="list-style-type: none"> <li>• <b>Columns</b></li> <li>• <b>Rows</b></li> </ul> <p>Default = <b>Columns</b></p>  |
| Sample width       | <p><b>Number:</b> Width in normalized units of the element sample that appears in the legend box. Range = 0 . 0 to 0 . 5. Move the slider to change the value. Default = 0 . 15</p>  |
| Horizontal spacing | <p><b>Number:</b> Space in normalized units between samples and text in the legend box. Range = 0 . 0 to 0 . 25. Move the slider to change the value. Default = 0 . 02</p>   |
| Vertical spacing   | <p><b>Number:</b> Space in normalized units between lines in the legend box. Move the slider to change the value. Default = 0 . 02</p>   |
| Text color         | <p><b>Color:</b> Color to be used for the legend text. Click to choose from the default color palette, or specify RGB values. Default = [ 0 , 0 , 0 ] (black)</p>  |

*Table D-70: Legend Properties*

| Property        | Control Type: Values   |
|-----------------|--|
| Text font       | <p><b>String List:</b> Font used for legend text. Select a font from the list. Choose from these values:</p> <ul style="list-style-type: none"> <li>• <b>Helvetica</b></li> <li>• <b>Courier</b></li> <li>• <b>Times</b></li> <li>• <b>Symbol</b></li> <li>• <b>Hershey</b></li> </ul> <p>Default = <b>Helvetica</b></p> |
| Text style      | <p><b>String List:</b> Style used for legend text. Select a style from the list. Choose from these values:</p> <ul style="list-style-type: none"> <li>• <b>Normal</b></li> <li>• <b>Bold</b></li> <li>• <b>Italic</b></li> <li>• <b>Bold italic</b></li> </ul> <p>Default = <b>Normal</b></p>                            |
| Text font size  | <p><b>Number:</b> Font size in points for the legend text. Edit the number to change the size. Default = 10</p>  |
| Color           | <p><b>Color:</b> Color to use for the legend border. Legend object must be deselected for border attributes to be visible. Click to choose from the default color palette, or specify RGB values. Default = [0, 0, 0] (black)</p>  |
| Linestyle       | <p><b>Line Style:</b> Style of the legend border. Select a line style from the list. Default =  (solid line)</p>   |
| Thickness       | <p><b>Line Thickness:</b> Thickness of the legend border in points. Select a thickness from the list. Default = 1</p>  |
| Fill background | <p><b>Boolean:</b> Fill legend background? Choose True or False. Default = <b>True</b></p>   |

Table D-70: Legend Properties (Continued)

| Property     | Control Type: Values   |
|--------------|--|
| Fill color   | <b>Color:</b> Color to be used for the background. For background color to display, Fill Background property must be set to <b>True</b> . Click to choose from the default color palette, or specify RGB values. Default = [255, 255, 255] (white) |
| Transparency | <b>Number:</b> Transparency of the background fill from 0% to 100% Move the slider to change the value. Default = <b>0%</b>  |

*Table D-70: Legend Properties (Continued)*

## Legend Contour Items

The following are properties of the top-level Contour legend item. For a description of how a particular control is used, refer to [Appendix B, “Property Controls”](#).

| Property       | Control Type: Values   |
|----------------|--|
| Show Levels    | <b>Boolean:</b> Show contour levels in the legend. Choose <b>True</b> or <b>False</b> . Default = <b>True</b>  |
| Text           | <b>String:</b> Text that labels the contour object in the legend.  |
| Text color     | <b>Color:</b> Color to be used for the legend text. Click to choose from the default color palette, or specify RGB values. Default = [0, 0, 0] (black)   |
| Text font      | <b>String List:</b> Font used for legend text. Select a font from the list. Choose from these values: <ul style="list-style-type: none"> <li>• <b>Helvetica</b></li> <li>• <b>Courier</b></li> <li>• <b>Times</b></li> <li>• <b>Symbol</b></li> <li>• <b>Hershey</b></li> </ul> Default = <b>Helvetica</b> |
| Text style     | <b>String List:</b> Style used for legend text. Select a style from the list. Choose from these values: <ul style="list-style-type: none"> <li>• <b>Normal</b></li> <li>• <b>Bold</b></li> <li>• <b>Italic</b></li> <li>• <b>Bold italic</b></li> </ul> Default = <b>Normal</b>                            |
| Text font size | <b>Number:</b> Font size in points for the legend text. Edit the number to change the size. Default = 12   |

Table D-71: Contour Legend Properties

## Legend Contour Level Items

The following are properties of individual Contour level legend items. For a description of how a particular control is used, refer to [Appendix B, “Property Controls”](#)

| Property         | Control Type: Values   |
|------------------|--|
| Text             | <b>String:</b> Text that labels the contour in the legend.   |
| Text color       | <b>Color:</b> Color to be used for the legend text. Click to choose from the default color palette, or specify RGB values. Default = [0, 0, 0] (black)   |
| Use text from    | <b>String List:</b> Choose a source for the legend text. Choose from these values: <ul style="list-style-type: none"> <li>• <b>Level value</b></li> <li>• Level label</li> <li>• User defined</li> </ul> Default = <b>Level value</b>  |
| Text format code | <b>String:</b> Text that defines the tick format. Edit string to change format. You can edit this value only if <b>Text Format</b> is set to <b>Use Tick Format Code</b> . Default = none  |
| Text format      | <b>String List:</b> Choose a format code or time interval to use for each legend item. Choose from these values: <ul style="list-style-type: none"> <li>• <b>None</b></li> <li>• <b>Use Text Format Code</b></li> <li>• Filled Fixed Width Integer</li> <li>• Freeform Integer or Float</li> <li>• Float with 2 or 4 decimal places</li> <li>• Exponential with 2 or 4 decimal places</li> <li>• <b>Date (13 formats)</b></li> <li>• <b>Time (11 formats)</b></li> </ul> Default = <b>None</b> |

Table D-72: Contour Level Legend Properties



| Property       | Control Type: Values   |
|----------------|--|
| Text font      | <p><b>String List:</b> Font used for legend text. Select a font from the list. Choose from these values:</p> <ul style="list-style-type: none"> <li>• <b>Helvetica</b></li> <li>• <b>Courier</b></li> <li>• <b>Times</b></li> <li>• <b>Symbol</b></li> <li>• <b>Hershey</b></li> </ul> <p>Default = <b>Helvetica</b></p> |
| Text style     | <p><b>String List:</b> Style used for legend text. Select a style from the list. Choose from these values:</p> <ul style="list-style-type: none"> <li>• <b>Normal</b></li> <li>• <b>Bold</b></li> <li>• <b>Italic</b></li> <li>• <b>Bold italic</b></li> </ul> <p>Default = <b>Normal</b></p>                            |
| Text font size | <p><b>Number:</b> Font size in points for the legend text. Edit the number to change the size. Default = <b>12</b></p>   |

*Table D-72: Contour Level Legend Properties (Continued)*

## Legend Plot Items

The following are properties of Plot legend items. For a description of how a particular control is used, refer to [Appendix B, “Property Controls”](#).

| Property       | Control Type: Values   |
|----------------|--|
| Text           | <b>String:</b> Text that labels the plot object in the legend.   |
| Text color     | <b>Color:</b> Color to be used for the legend text. Click to choose from the default color palette, or specify RGB values. Default = [0, 0, 0] (black)   |
| Text font      | <b>String List:</b> Font used for legend text. Select a font from the list. Choose from these values: <ul style="list-style-type: none"> <li>• <b>Helvetica</b></li> <li>• <b>Courier</b></li> <li>• <b>Times</b></li> <li>• <b>Symbol</b></li> <li>• <b>Hershey</b></li> </ul> Default = <b>Helvetica</b> |
| Text style     | <b>String List:</b> Style used for legend text. Select a style from the list. Choose from these values: <ul style="list-style-type: none"> <li>• <b>Normal</b></li> <li>• <b>Bold</b></li> <li>• <b>Italic</b></li> <li>• <b>Bold italic</b></li> </ul> Default = <b>Normal</b>                            |
| Text font size | <b>Number:</b> Font size in points for the legend text. Edit the number to change the size. Default = <b>12</b>  |

*Table D-73: Plot Legend Properties*

## Legend Surface Items

The following are properties of individual Surface legend items. For a description of how a particular control is used, refer to [Appendix B, “Property Controls”](#).

| Property       | Control Type: Values   |
|----------------|--|
| Text           | <b>String:</b> Text that labels the surface object in the legend.  |
| Text color     | <b>Color:</b> Color to be used for the legend text. Click to choose from the default color palette, or specify RGB values. Default = [0, 0, 0] (black)   |
| Text font      | <b>String List:</b> Font used for legend text. Select a font from the list. Choose from these values: <ul style="list-style-type: none"> <li>• <b>Helvetica</b></li> <li>• <b>Courier</b></li> <li>• <b>Times</b></li> <li>• <b>Symbol</b></li> <li>• <b>Hershey</b></li> </ul> Default = <b>Helvetica</b> |
| Text style     | <b>String List:</b> Style used for legend text. Select a style from the list. Choose from these values: <ul style="list-style-type: none"> <li>• <b>Normal</b></li> <li>• <b>Bold</b></li> <li>• <b>Italic</b></li> <li>• <b>Bold italic</b></li> </ul> Default = <b>Normal</b>                            |
| Text font size | <b>Number:</b> Font size in points for the legend text. Edit the number to change the size. Default = 12   |

*Table D-74: Surface Legend Properties*



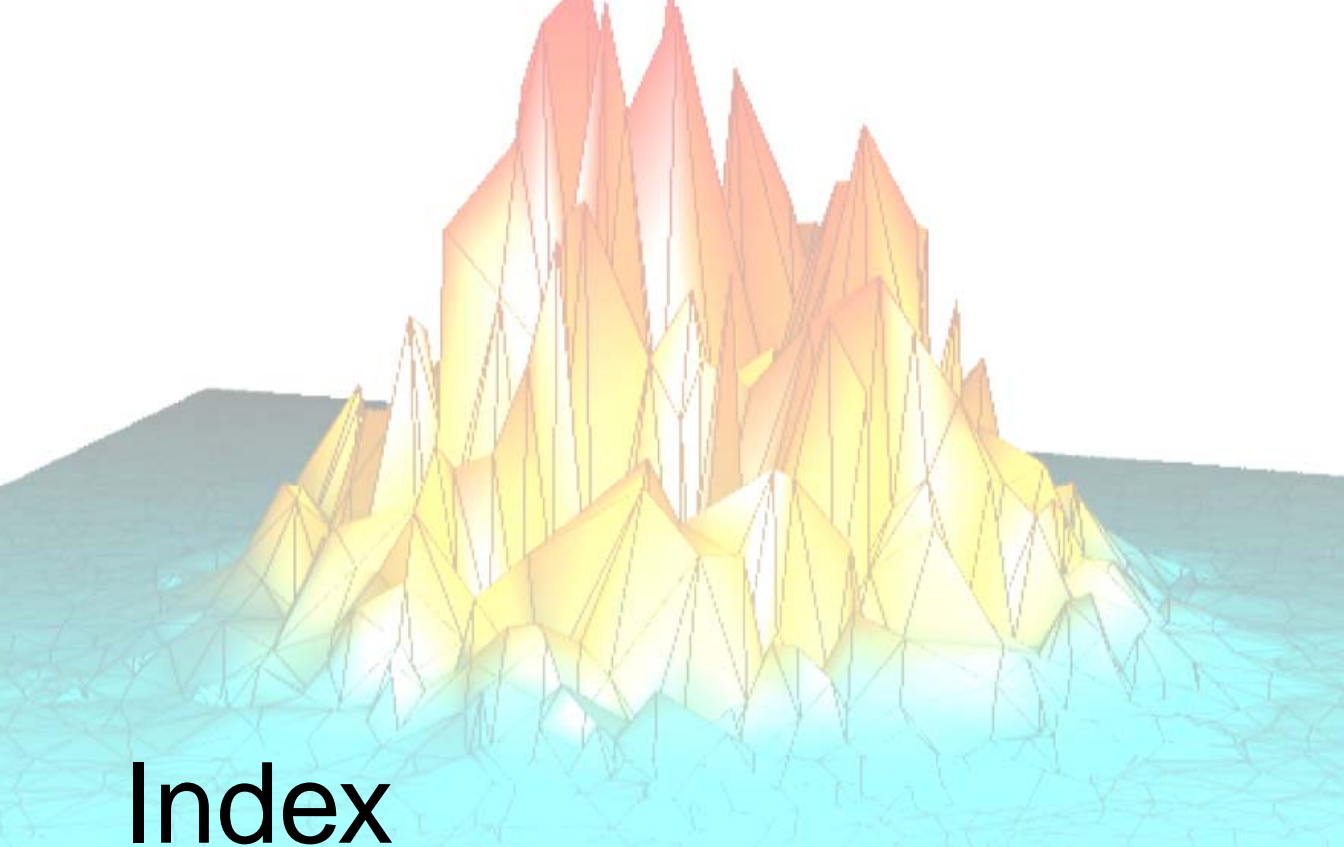

# Index

## *Numerics*

### 2D

annotation layer, [480](#)

### 3D

#### plots

properties, [425](#)

## A

### adding

plot axis object, [84](#)

### annotating

#### iTools

contours, [275](#)

freehand type, [83](#)

images, [226](#)

line type, [80](#)

oval type, [81](#)

plots, [297](#)

polygon type, [82](#)

rectangle type, [81](#)

text, [79](#)

toolbar for, [367](#)

types of, [79](#)

volumes, [318](#)

annotation layer, [480](#)

### axes

#### adding to

contours, [271](#)

images, [216](#)

iTools, [84](#)

surfaces, [240](#)

volumes, [311](#)

properties, [458](#)

**B**

byte scale properties, [391](#)

**C**

canvas zooming, [70](#)

colorbars

adding to

contours, [269](#)

images, [215](#)

plots, [289](#)

surfaces, [237](#)

volumes, [310](#)

properties, [450](#)

colors

changing in contours, [266](#)

in iImage, [212](#)

containers

definition, [176](#)

contour, [398](#)

contours

adding an axis, [271](#)

adding statistics, [277](#)

annotations (iTools), [275](#)

colorbar, [269](#), [270](#)

colors in, [266](#)

displaying

in iContour, [255](#)

in iMap, [340](#)

filling, [267](#)

filtering, [272](#)

flipping, [274](#)

histogram, [277](#)

labelling, [264](#)

legend level properties, [496](#)

legend properties, [495](#)

on surface data, [242](#)

properties, [262](#)

properties of, [432](#)

convolution

filtering, [122](#)

properties, [380](#)

cropping images

iTools, [395](#)

curve fitting

for plots, [292](#)

curve fitting filtering, [384](#)

**D**

data

importing in iTool, [27](#)

manager, [24](#)

data associations

removing, [57](#)

replacing, [57](#)

data manager, [24](#)

dataspace

adding, [63](#)

properties, [413](#)

range resetting, [129](#)

displaying

2D plots, [281](#)

3D plots, [282](#)

contours

in iContour, [255](#)

in iMap, [340](#)

images

in iImage, [207](#)

in iMap, [332](#)

irregular-grid data, [256](#)

maps, [325](#)

multi-channel volumes, [303](#)

regular-grid data, [255](#)

statistics, [127](#)

surfaces, [233](#)

volumes, [303](#)

drag quality, [409](#)

**E**

error bar plots, 290

**F**

file menu, 353

files

operations, 111

toolbar, 364

writing

file writers, 104

filling

contours

iTools, 267

filtering

contours, 272

convolution, 122

data in iTools, 120

images in iImage, 218

median, 121

plots, 295

smooth filter, 120

surfaces, 245

unsharp mask, 123

flipping

contours, 274

images, 224

freehand annotations

adding, 83

properties, 490

**G**

general settings, iTool preferences browser, 97

gridding wizard, 257

**H**

help menu, 363

histogram

adding to a volume, 320

for contours, 277

plot, 126, 299

properties, 379, 455

surface, 252

**I**

iImage images

adding

axis, 216

colorbar, 215

surface, 223

annotating, 226

brightness, 213

contouring, 221

cropping, 227

displaying, 207

displaying multiple, 208

filtering, 218

flipping, 224

inverting, 224

line profiling, 226

manipulating, 224

modifying properties, 214

morphing, 220

of surface data, 241

panning, 227

pixel scaling, 225

region growing, 225

registering in iMap, 333

resampling, 217

ROIs, 212

rotating, 224

scaling, 224

window level control, 212

zooming, 225

iImage tool

color in, 212

image properties, 418

- image display
  - in iImage, 207
  - in iMap, 332
  - multiple images, 208
- image panel (IIMAGE), 211
- image plane
  - about, 313
  - for volumes, 313
  - properties, 401, 403, 447
- image stack, iVolume, 320
- images
  - displaying. *See* image display
  - in iImage. *See* iImage images
- importing
  - data in iTool, 27
- insert menu, 358
- inserting
  - map grid, 342
  - shapefiles, 343
- interval volume
  - extracting in volumes, 316
  - properties, 445
- inverting images, 224, 391
- iPlot
  - properties, 422
- irregularly-gridded data, 256
- isosurfaces
  - extracting in volumes, 314
  - properties, 443
- iSurface tool
  - properties, 428
- iTools
  - annotation toolbar, 367
  - common operations, 110
  - edit menu, 355
  - edit toolbar, 365
  - file menu, 353
  - file toolbar, 364
  - help menu, 363
  - insert menu, 358
  - inserting a visualization, 54

- manipulator toolbar, 366
- operations menu, 359
- view properties, 410
- window menu, 362
- window properties, 408
- iVolume tool
  - image stack, 320

## L

- labelling
  - contours, 264
- layout window, 73
- legends
  - adding, 77
    - to contours, 270
    - to plots, 287
    - to surfaces, 239
  - properties, 491
- lights
  - adding to a surface, 238
  - properties, 466
- line annotations
  - adding, 80
  - properties, 483
- lines
  - profiles
    - annotating, 484
    - extracting for a surface, 251
    - in images, 226

## M

- Macro Controls dialog, 147
- Macro Editor
  - Add and Remove buttons, 159
  - items
    - annotation, 167
    - history, 163
    - macro, 161



- Macro Tools, 168
- Tool Menus, 174
- visualization, 166
- macro property sheet, 154
- macro tree, 154
- menu bar, 152
- source property sheet, 158
- source tree, 157
- using, 151
- macros
  - iTool
    - definition, 139
    - exporting, 183
    - importing, 183
    - properties, 377
    - recording, 141
    - running, 144
      - IDL command line, 146
      - Macro Editor, 146
      - Operations menu, 145
      - Selection Change operation, 177, 178
      - Tool Change operation, 180, 181
      - types, 176
- manipulating images
  - in iTools, 224
- manipulating volume data
  - in iTools, 318
- manipulator toolbar, 366
- map grid, inserting, 342
- map panel (IMAP), 330
- map projection
  - applying, 326
- map projections
  - common properties (iTools), 326
  - definition, 326
  - properties, 392
- map register image operation properties
  - (iTools), 393
- maps, displaying in IMAP, 325
- median
  - filtering, 121

- morphing
  - data, 125
  - images, 220
  - properties, 394
- multi-channel volumes, 303

## O

- objects
  - rendering translucent, 130
  - scaling, 65
  - selecting, 61
  - selecting all, 61
  - translating, 64
- operations
  - browser, 93, 376
  - common, 110
  - file, 111
  - menu, 359
  - property sheets, 88
- oval annotations, 81
- overplotting
  - IPLLOT, 284

## P

- panel
  - IIMAGE, 211
  - IMAP, 330
  - IVOLUME, 307
- panning images
  - IIMAGE, 227
- parameter editor, 56
- parameters
  - editor, 56
- plots
  - histogram, 126
  - legend, 498
- plotting
  - IPLLOT

- adding a histogram to, 299
- annotating, 297
- colorbar, 289
- curve fitting, 292
- displaying 2-D, 281
- displaying 3-D, 282
- displaying polar, 283
- error bars, 290
- filtering, 295
- legend, 287
- modifying properties for, 286
- scaling, 299
- statistics, 299
- translating, 297
- overplotting
  - IPlot, 284
- polar plots
  - IPlot, 283
- polygon annotations, 489
  - creating, 82
- polygonal ROIs, 469, 472, 476, 478, 479
- preferences
  - browser in iTools, 95
- printing
  - iTools, 132
- properties
  - 2D annotation layer, 480
  - 3D plot, 425
  - axis, 458
  - byte scale, 391
  - colorbar, 450
  - contour, 398, 432
  - contour legend, 495
  - contour legend level, 496
  - contours, 262
  - convolution, 380
  - cropping, 395
  - curve fitting, 384
  - dataspace, 413
  - freehand annotation, 490
  - histogram, 379, 455
  - image, 418
  - image plane, 401, 403, 447
  - interval volume, 445
  - inverting image, 391
  - iPlot, 422
  - isosurface, 443
  - iSurface, 428
  - iTool macros, 377
  - legend, 491
  - lights, 466
  - line annotation, 483
  - line profile annotation, 484
  - map projection, 392
  - map register image (iTools), 393
  - modifying volume, 309
  - morphing, 394
  - operations browser, 376
  - plot legend, 498
  - polygon annotation
    - properties, 489
  - polygonal ROIs, 469, 472, 476, 478, 479
  - rectangle annotation, 487
  - region grow, 396
  - resample, 388
  - Roberts filter, 383
  - rotate, 387
  - rotate data, 389
  - scale data, 390
  - sheets
    - defined, 87
    - operations, 88
    - visualization, 88
  - smooth filter, 382, 383
  - Sobel filter, 383
  - statistics, 378
  - surface legend, 499
  - transform, 388
  - unsharp mask filter, 384
  - view, 410
  - visualization layer, 411
  - visualization type, 417

volume, [437](#)  
 window, [408](#)

## R

reading  
   files, [99](#)  
 rectangle annotations  
   creating, [81](#)  
   properties, [487](#)  
 redo iTool operation, [62](#)  
 region grow  
   iTool operation properties, [396](#)  
 region of interest  
   operations and, [131](#)  
 registering  
   images  
     in degrees, [338](#)  
     in meters, [335](#)  
     wizard, [333](#)  
 regular-grid data displays, [255](#)  
 rendering  
   translucent objects, [130](#)  
   volumes, [304](#)  
 resampling  
   data, [117](#)  
   images, [217](#)  
   properties, [388](#)  
   surfaces, [244](#)  
   volumes, [312](#)  
 resetting dataspace, [129](#)  
 Roberts filter, [383](#)  
 rotating  
   data, [113](#), [118](#)  
   image, [224](#)  
   left, [115](#)  
   properties, [387](#), [389](#)  
   right, [115](#)  
   surfaces, [247](#)  
   volumes, [318](#)  
   with a mouse, [113](#)

## S

scaling  
   3-D objects, [65](#)  
   constrained, [65](#)  
   data, [119](#)  
   images, [224](#)  
   objects, [65](#)  
   plots, [299](#)  
   properties, [390](#)  
   surfaces, [249](#)  
   unconstrained, [67](#)  
   unconstrained 2-D objects, [68](#)  
   unconstrained 3-D objects, [69](#)  
   volumes, [318](#)  
 selecting  
   objects, [61](#)  
 shape visualization  
   creating, [341](#)  
 Shapefile  
   creating a visualization, [341](#)  
   definition, [341](#)  
   inserting, [343](#)  
     Canadian provinces, [348](#)  
     continents, [343](#)  
     countries (high resolution), [344](#)  
     countries (low resolution), [344](#)  
     lakes, [346](#)  
     rivers, [345](#)  
     United States, [347](#)  
 smooth filtering, [120](#), [382](#), [383](#)  
 smoothing  
   volumes, [320](#)  
 Sobel  
   filter, [383](#)  
 statistics  
   adding to plots, [299](#)  
   adding to volumes, [320](#)  
   displaying, [127](#)  
   properties, [378](#)  
   surface, [252](#)  
 styles

- applying, 187
- copying, 193
- creating, 188
- current style, 193
- default style, 203
- definition, 186
- editing, 200
- exporting, 204
- importing, 204
- types, 186

surfaces

- adding axes, 240
- adding texture map, 246
- adding to an image, 223
- colorbar, 237
- creating contours on, 242
- creating images of, 241
- displaying, 233
- extracting a line profile, 251
- filtering, 245
- histogram for, 252
- legends, 239, 499
- lights, 238
- rotating, 247
- scaling, 249
- statistics, 252

## T

- text annotations, 79
- texture maps
  - iTools, 246
- three-dimensional plots, 425
- transforming
  - data, 117
  - properties, 388
  - resampling, 117
  - rotate data, 118
  - scale data, 119
- translating
  - objects, 64

- plots, 297
- translucent object rendering, 130

## U

- undo iTool operation, 62
- unsharp mask
  - filtering, 123
- unsharp mask filter, 384

## V

- view zooming, 70
- visualizations
  - browser, 90
  - creating, 53
  - definition of, 52
  - exporting, 58
  - inserting, 54
  - layers, 411
  - modifying, 56
  - object selection, 90
  - property sheets, 88
  - type properties, 417
- volume panel (IVOLUME), 307
- volumes
  - adding a colorbar to, 310
  - adding a histogram to, 320
  - adding an axis to, 311
  - adding statistics to, 320
  - annotating, 318
  - displaying, 303
  - displaying multi-channel, 303
  - extents, 306
  - extracting an interval volume in, 316
  - extracting an isosurface for, 314
  - properties, 309, 437
  - rendering, 304
  - resampling, 312
  - rotating, 318

scaling, [318](#)  
showing an image plane for, [313](#)  
smoothing, [320](#)

## W

window layout, [73](#)

window level control, [212](#)  
window menu, [362](#)  
writing files, [104](#)

## Z

zooming, [70](#)

