

# EnSight User Manual

*for Version 8.0*

## Table of Contents

- 1 Overview
- 2 Input
- 3 Parts
- 4 Variables
- 5 GUI Overview
- 6 Main Menu
- 7 Features
- 8 Modes
- 9 Transformation Control
- 10 Preference File Formats
- 11 EnSight Data Formats
- 12 Utility Programs
- 13 Parallel Rendering and Virtual Reality

Index

How To Table of Contents



Computational Engineering International, Inc.  
2166 N. Salem Street, Suite 101, Apex, NC 27523  
USA • 919-363-0883 • 919-363-0833 FAX  
<http://www.ceintl.com> or <http://www.ensight.com>

### EN-UM Revision History

EN-UM:5.2-1	October 1994
EN-UM:5.2.2-1	January 1995
EN-UM:5.5-1	September 1995
EN-UM:5.5.1-1	December 1995
EN-UM:5.5.2-1	February 1996
EN-UM:6.0-1	June 1997
EN-UM:6.0-2	August 1997
EN-UM:6.0-3	October 1997
EN-UM:6.0-4	October 1997
EN-UM:6.1-1	March 1998
EN-UM:6.2-1	September 1998
EN-UM:6.2.1-1	November 1998
EN-UM:7.0-1	December 1999
EN-UM:7.1-1	April 2000
EN-UM:7.3-1	March 2001
EN-UM:7.4-1	March 2002
EN-UM:7.4-2	October 2002
EN-UM:7.6-1	May 2003
EN-UM:8.0-1	December 2004

This document has been reviewed and approved in accordance with Computational Engineering International, Inc. Documentation Review and Approval Procedures.

This document should be used only for Version 8.0 and greater of the EnSight program.

Information in this document is subject to change without notice. This document contains proprietary information of Computational Engineering International, Inc. The contents of this document may not be disclosed to third parties, copied, or duplicated in any form, in whole or in part, unless permitted by contract or by written permission of Computational Engineering International, Inc. Computational Engineering International, Inc. does not warranty the content or accuracy of any foreign translations of this document not made by itself. The Computational Engineering International, Inc. Software License Agreement and Contract for Support and Maintenance Service supersede and take precedence over any information in this document.

EnSight® is a registered trademark of Computational Engineering International, Inc. All registered trademarks used in this document remain the property of their respective owners.

CEI's World Wide Web addresses:

<http://www.ceintl.com>

or

<http://www.ensight.com>

### Restricted Rights Legend

Use, duplication, or disclosure of the technical data contained in this document by the Government is subject to restrictions as set forth in subparagraph (c)(1)(ii) of the Rights in Technical Data and Computer Software clause at DFARS 252.227-7013. Unpublished rights reserved under the Copyright Laws of the United States.

Contractor/Manufacturer is Computational Engineering International, Inc., 2166 N. Salem Street, Suite 101, Apex, NC 27523 USA

# Table of Contents

## 1 Overview

## 2 Input

2.1 Reader Basics .....	2-2
Dataset Format Basics .....	2-2
Reading and Loading Data Basics .....	2-2
2.2 Native EnSight Format Readers .....	2-12
EnSight Case Reader .....	2-13
EnSight5 Reader .....	2-14
2.3 Other Readers .....	2-15
ABAQUS_FIL Reader .....	2-17
ABAQUS_ODB Reader .....	2-18
Medina BIF-BOF PERMAS Reader .....	2-19
ANSYS Reader .....	2-20
AVUS Reader .....	2-21
CFF Reader .....	2-22
CFX4 Reader .....	2-23
CGNS Reader .....	2-24
ESTET Reader .....	2-25
EXODUS II Gold Reader .....	2-27
FAST UNSTRUCTURED Reader .....	2-31
FIDAP NEUTRAL Reader .....	2-32
FLUENT Direct Reader .....	2-33
FLUENT UNIVERSAL Reader .....	2-33
HDF Reader .....	2-35
LS-DYNA Reader .....	2-36
Movie.BYU Reader .....	2-39
MPGS 4.1 Reader .....	2-40
MSC.DYTRAN Reader .....	2-41

MSC.NASTRAN Reader . . . . .	2-42
N3S Reader . . . . .	2-43
NetCDF Reader . . . . .	2-45
PLOT3D Reader . . . . .	2-46
RADIOSS Reader . . . . .	2-48
SCRYU Reader . . . . .	2-49
SILO Reader . . . . .	2-50
STL Reader . . . . .	2-52
Tecplot Reader . . . . .	2-54
Vectis Reader . . . . .	2-56
<b>2.4 Other External Data Sources . . . . .</b>	<b>2-57</b>
External Translators . . . . .	2-57
Exported from Analysis Codes . . . . .	2-57
<b>2.5 Command Files . . . . .</b>	<b>2-58</b>
Saving the Default Command File for EnSight Session . . . . .	2-60
Auto recovery . . . . .	2-61
<b>2.6 Archive Files . . . . .</b>	<b>2-62</b>
Saving and Restoring a Full backup . . . . .	2-62
<b>2.7 Context Files . . . . .</b>	<b>2-65</b>
Saving a Context File . . . . .	2-65
Restoring a Context. . . . .	2-65
<b>2.8 Scenario Files . . . . .</b>	<b>2-67</b>
<b>2.9 Saving Geometry and Results Within EnSight. . . . .</b>	<b>2-69</b>
Saving Geometric Entities . . . . .	2-69
<b>2.10 Saving and Restoring View States. . . . .</b>	<b>2-72</b>
<b>2.11 Saving and Printing Graphic Images . . . . .</b>	<b>2-73</b>
<i>Troubleshooting Saving an Image.</i> . . . . .	2-77
<b>2.12 Saving and Loading XY Plot Data . . . . .</b>	<b>2-78</b>
<b>2.13 Saving and Restoring Animation Frames. . . . .</b>	<b>2-79</b>
<b>2.14 Saving Query Text Information . . . . .</b>	<b>2-80</b>

From Query/Plot Save... Formatted .....	2-80
From Query/Plot Show Text. ....	2-80
From EnSight Message Window .....	2-81
2.15 Saving Your EnSight Environment. ....	2-82
<b>3 Parts</b>	
3.1 Part Overview .....	3-2
Part Creation .....	3-6
Part Attributes .....	3-6
3.2 Part Selection and Identification .....	3-8
3.3 Part Editing .....	3-10
Variable & Legend Color Palette Icon .....	3-12
Variable Creation (Calculator) Icon .....	3-12
3.4 Part Operations .....	3-23
3.5 Part Shortcuts (Right-click) .....	3-27
<b>4 Variables</b>	
General Description .....	4-1
4.1 Variable Selection and Activation .....	4-3
4.2 Variable Summary & Palette .....	4-5
4.3 Variable Creation .....	4-10
<b>5 GUI Overview</b>	
GUI Conventions .....	5-5
<b>6 Main Menu</b>	
6.1 File Menu Functions. ....	6-2
6.2 Edit Menu Functions .....	6-5

6.3 Query Menu Functions . . . . .	6-21
6.4 View Menu Functions . . . . .	6-24
6.5 Tools Menu Functions . . . . .	6-29
6.6 Case Menu Functions . . . . .	6-40
6.7 Help Menu Functions . . . . .	6-42

## 7 Features

7.1 Solution Time . . . . .	7-2
7.2 Flipbook Animation . . . . .	7-6
7.3 Keyframe Animation . . . . .	7-12
7.4 Variable Calculator . . . . .	7-21
7.5 Query/Plot . . . . .	7-22
7.6 Interactive Probe Query . . . . .	7-32
7.7 Contour Create/Update . . . . .	7-34
7.8 Isosurface Create/Update . . . . .	7-38
7.9 Clip Create/Update . . . . .	7-42
7.10 Vector Arrow Create/Update . . . . .	7-60
7.11 Particle Trace Create/Update . . . . .	7-65
7.12 Subset Parts Create/Update . . . . .	7-80
7.13 Profile Create/Update . . . . .	7-82
7.14 Elevated Surface Create/Update . . . . .	7-86
7.15 Vortex Core Create/Update . . . . .	7-89
7.16 Shock Surface/Region Create/Update . . . . .	7-93
7.17 Separation/Attachment Lines Create/Update . . . . .	7-99
7.18 Boundary Layer Variables Create/Update . . . . .	7-103

7.19 Material Parts Create/Update . . . . .	7-108
7.20 Developed Surface Create/Update . . . . .	7-112
7.21 Tensor Glyph Parts Create/Update . . . . .	7-116

## 8 Modes

8.1 Part Mode . . . . .	8-2
8.2 Annot Mode . . . . .	8-12
8.3 Plot Mode. . . . .	8-18
8.4 VPort Mode . . . . .	8-25
8.5 Frame Mode. . . . .	8-34
8.6 Quick Desktop Buttons . . . . .	8-44

## 9 Transformation Control

General Description . . . . .	9-1
9.1 Global Transform . . . . .	9-3
9.2 Frame Definition. . . . .	9-8
9.3 Frame Transform . . . . .	9-11
9.4 Tool Transform. . . . .	9-15
9.5 Center Of Transform . . . . .	9-16
9.6 Z-Clip . . . . .	9-17
9.7 Look At/Look From. . . . .	9-19
9.8 Copy/Paste Transformation State . . . . .	9-22

## 10 Preference File Formats

10.1 Window Position File Format . . . . .	10-2
10.2 Connection Information File Format. . . . .	10-3

10.3 Palette File Formats . . . . .	10-4
Color Selector Palette File Format . . . . .	10-4
Function Palette File Format . . . . .	10-4
Predefined Function Palette . . . . .	10-5
Default False Color Map File Format . . . . .	10-6
10.4 Default Part Colors File Format . . . . .	10-7
10.5 Data Reader Preferences File Format . . . . .	10-8
10.6 Data Format Extension Map File Format . . . . .	10-9
10.7 Parallel Rendering Configuration File . . . . .	10-11

## 11 EnSight Data Formats

11.1 EnSight Gold Casefile Format . . . . .	11-3
EnSight Gold General Description . . . . .	11-3
EnSight Gold Geometry File Format . . . . .	11-6
EnSight Gold Case File Format . . . . .	11-32
EnSight Gold Variable File Format . . . . .	11-41
EnSight Gold Per_Node Variable File Format . . . . .	11-41
EnSight Gold Per_Element Variable File Format . . . . .	11-57
EnSight Gold Undefined Variable Values Format . . . . .	11-71
EnSight Gold Partial Variable Values Format . . . . .	11-75
EnSight Gold Measured/Particle File Format . . . . .	11-80
EnSight Gold Material Files Format . . . . .	11-81
11.2 EnSight6 Casefile Format . . . . .	11-89
EnSight6 General Description . . . . .	11-89
EnSight6 Geometry File Format . . . . .	11-92
EnSight6 Case File Format . . . . .	11-97
EnSight6 Variable File Format . . . . .	11-104
EnSight6 Per_Node Variable File Format . . . . .	11-105
EnSight6 Per_Element Variable File Format . . . . .	11-108
EnSight6 Measured/Particle File Format . . . . .	11-112
Writing EnSight6 Binary Files . . . . .	11-112



11.3 EnSight5 Format .....	11-117
EnSight5 General Description .....	11-117
EnSight5 Geometry File Format.....	11-119
EnSight5 Result File Format .....	11-123
EnSight5 Variable File Format.....	11-125
EnSight5 Measured/Particle File Format.....	11-126
Writing EnSight5 Binary Files.....	11-129
11.4 FAST UNSTRUCTURED Results File Format.....	11-132
11.5 FLUENT UNIVERSAL Results File Format.....	11-136
11.6 Movie.BYU Results File Format.....	11-138
11.7 PLOT3D Results File Format.....	11-141
11.8 Server-of-Server Casefile Format .....	11-146
11.9 Periodic Matchfile Format .....	11-150
11.10 XY Plot Data Format .....	11-153
11.11 EnSight Boundary File Format .....	11-155
11.12 EnSight Particle Emitter File Format.....	11-159
<b>12 Utility Programs</b>	
12.1 EnSight5 Programs .....	12-2
12.2 MPGS4 Programs .....	12-6
12.3 Keyboard Macro Maker (macromake).....	12-7
12.4 Web Publisher/Project Management (scenario_html_publisher) ..	12-8
<b>13 Parallel Rendering and Virtual Reality</b>	



# 1 Overview

EnSight (for Engineering inSight) provides engineers and scientists with an easy-to-use graphics postprocessing package. EnSight supplies powerful, easy-to-use tools through a user-friendly interface.

The purpose of this chapter is to give you an overview of the EnSight system and its documentation. Because of the power and flexibility of EnSight, the synergy between features provides a great many visualization techniques.

The Overview topics discussed are:

**Part Concepts**

**Data Types**

**Graphical Environment**

**Transformations**

**Frames**

**Coloration**

**Created Parts**

**Queries**

**Transient Data**

**Animation**

**Implementation**

**Documentation**

**Contacting CEI**

## Part Concepts

EnSight processing begins with your model. Usually the elements of your model are grouped into parts. *Within EnSight, nearly all information is associated with parts, and nearly all actions are applied to parts.*

## Geometry

A part consists of *nodes* and *elements* (elements are sets of nodes connected in a particular geometric shape). Each node, which is shared by its adjoining elements, is defined by its coordinate-location in the model frame of reference.

## Variable Values

EnSight-compatible data files provide variable values either at each part's nodes, element centers, or both. When needed (or requested) EnSight will find any variable's value at any point on or within an element by utilizing the element's shape function.

*Part Attributes*

Within EnSight, you can specify additional information about each part. These *part attributes* tell EnSight how to display each part and how the part responds to EnSight controls and display options. Part attributes include:

Category	Includes attributes that control...
General Attributes	Visibility (including visibility per viewport) Susceptibility to Auxiliary Clipping Reference frame Response to changes in time (frozen or active) Fast display representation Visual Symmetry options Coloration (constant or by a palette associated with a variable) Shaded Surface susceptibility Surface shading (flat, Gouraud, smooth) Hidden Line susceptibility Fill density (for transparency) Lighting (diffuse, shininess, and highlight intensity)
Node, Element, and Line Attributes	Node visibility Node type (dot, cross, or sphere) Node size (constant or variable) Node detail (for spheres) Element-line visibility Element-line width Element-line style (solid, dotted, or dot-dash) Element representation on client (full, border, 3D border/2D full, 3D feature/2D full, 3D nonvisual/2D full, bounding box, feature angle, or nonvisual) Element-size shrink-factor Polygon Reduction Failed element variable and rules Node and element label visibility
Displacement Attributes	Displacement variable and scale factor
IJK axis display attributes	IJK axis visibility and scale factor

*Part Operations*

Parts can be copied to show, for example, the same part colored by a different variable. Model parts can be split along an arbitrary plane or any quadric surface, and merged with other model parts. The geometry of parts can be simplified by creating a new part by extracting a simpler representation of an existing part.

*Part Representation*

Parts can be represented with simpler geometry, both to enhance visualization performance and for special effects. Representation modes include:

Full mode, which represents all the part's elements in the graphics window.

Border mode, which represents 3D elements with their 2D external faces.

Feature angle mode, which represents with 1D elements the "significant" edges of the part (you control what is "significant")

Nonvisual, which does not represent any of the part's elements in the graphics window (but still loads in memory on the server).

Bounding box, which represents the box bounding the coordinate extremes.

(see [Section 3.3, Part Editing](#), and [Section 8.1, Part Mode](#))

## Data Types

EnSight supports a number of common data formats as well as interfaces to various simulation packages. If an interface is not available for your data, EnSight includes a library of routines to create your own custom User-Defined Reader. User-Defined Readers have the advantage of not requiring a separate data translation step and thus reduce user effort and disk storage requirements. A number of User-Defined Readers are provided with EnSight; complete documentation and dummy routines may be found in the directory `$CEI_HOME/ensight80/src/readers`.

There are four different means to get your data into EnSight.

**Type 1 - Included Readers** - Are accessed by choosing the desired format in the Data Reader dialog. These include common data formats as well as a number of readers for commercial software. These can be internal EnSight readers as well as User-Defined Readers. If the included reader is a User-Defined Reader there may be more info in a README file found in `$CEI_HOME/ensight80/src/readers`.

**Type 2 - Not Included User-Defined readers** - A number of User-Defined Readers have been authored by EnSight users, but are not provided with EnSight. See the Comments column below for more information. Also for more info see our website, [www.ensight.com](http://www.ensight.com) and go to the Support page.

**Type 3 - Stand - Alone Translators** - May be written by the user to convert data into EnSight format files. A complete description of EnSight formats may be found in Chapter 11 of the EnSight Online User Manual. Several translators are provided with EnSight. These are found in the directory `$CEI_HOME/ensight80/translators`. Translators must first be compiled before they may be used. Some require links to libraries provided by the vendor of the program in question. See the README files found in each translator's directory.

**Type 4 - EnSight Format** - A growing number of software suppliers support the EnSight format directly, i.e. an option is provided in their products to output data in the EnSight format.

The table that follows summarizes all of the data formats and software packages for which an interface of Type 1-4 exists. As this information changes frequently, please consult our website ([www.ensight.com](http://www.ensight.com)) or your EnSight support representative should you have any questions. If your format or program is not listed here, there is the possibility that an interface does indeed exist. Contact EnSight support for assistance. Should you create a User-Defined Reader or Stand-Alone Translator and wish to allow its distribution with EnSight, please send an email to this effect to [support@ensight.com](mailto:support@ensight.com).

Data Format / Program	Type	Comments
ABAQUS_FIL	1	Direct reader for binary or ascii (.fil) files (ABAQUS STANDARD or EXPLICIT)
ABAQUS_ODB	1	Direct reader for binary .odb files (ABAQUS STANDARD or EXPLICIT)
ACUSOLVE	2	Contact vendor for information
ADAGIO	1	Use Exodus II reader
ADINA	3	Use I-DEAS neutral files and translators
ALEGRA	1	Use Exodus II reader
ANSYS	1	Direct reader for binary .rst, .rth, .rmq, .rfl files

Data Format / Program	Type	Comments
AVUS	1, 4	Formerly COBALT. User reader - or - Exports EnSight Case Gold format
CASE (EnSight6/EnSight Gold)	1	Native EnSight formats, EnSight6 Case and EnSight Gold Case
CFD++	4	Exports EnSight Case format
CFD-ACE	2	Contact vendor for DTF reader
CFD-FASTRAN	2	Contact vendor for DTF reader
CFDESIGN	1	Uses Tecplot files and reader
CFE	1	User reader for Common File Format from BOEING (WIND/CFE code). Source supplied with EnSight install, executable supplied on some platforms.
CFX4	1, 3	User reader, and translator (useful if results contain massed particles)
CFX5	4	Code exports EnSight Case format
CFX-TASCflow	3	Converts TASCflow output to EnSight format (or use PLOT3D converter from vendor)
CGNS	3	User reader
COBALT	1, 4	See AVUS User reader - or - Exports EnSight Case Gold format
CRAFT	4	Exports EnSight Case Gold format
CRUNCH	4	Exports EnSight Case Gold format
CTH	1	Use Exodus II reader
DMC	1	Use Exodus II reader
ECLIPSE	3	Contact CEI for details
ENSIGHT (EnSight 5)	1	Original EnSight format (unstructured)
ESTET	1	Direct reader
EXODUS II	1	User reader
FAST Unstructured	1	Direct reader for NASA FAST unstructured format
FEFLO	3	Contact vendor for information
FEMWATER	2	Use GMS reader
FENSAP	4	Contact vendor for information
FIDAP	1	Direct reader for FIDAP neutral (FDNEUT) files
FINE/Aero	1	Use PLOT3D or CGNS files/reader
FINE/Turbo	1	Use PLOT3D or CGNS files/reader
FIRE	4	Code exports EnSight format
FLOW-3D	1	User reader for FLOW-3D results (flsgrf) files
FLUENT (particle files)	3	Converts Fluent particle file to EnSight format
FLUENT	1, 4	Internal reader - or - Fluent exports EnSight Casefile format
FOAM	2, 4	Contact developer (Imperial College) for interface details
GASP	4	Exports EnSight Case format
GMS	2	User reader for GMS groundwater modeling framework, contact CEI for information
GUST	4	Exports EnSight Case format
HDF	2	Contact CEI for information
I-DEAS	3	Translator for I-DEAS FEA neutral file
IMEX	2	Contact CEI
IO/API	2	User reader for MODELS 3 framework, contact CEI for information
KIVA	2, 3,4	Conversion routines to export EnSight format, contact CEI for info
LS-DYNA	1	User reader for d3plot files
MADYMO	1	Use LS-DYNA reader
MAGMA	2	Contact CEI
MAYA ESC	4	Contact vendor for information
MODELS 3	2	Use IO/API reader
MOVIE.BYU	1	Direct reader for MOVIE.BYU format files
MPGS 4.1	1	Direct reader for MPGS, EnSight's predecessor
MSC.ADAMS	4	Plug-in support
MSC.DYTRAN	1	User reader for MSC/Dytran archive (.arc) or data (.dat) files
MSC MARC	3	Use PATRAN to EnSight PCL exporter. Contact CEI.

Data Format / Program	Type	Comments
MSC.NASTRAN	1	User reader for binary OP2 files
MSC.PATRAN	3	Converts PATRAN neutral files to MOVIE.BYU format -or- export to EnSight using PATRAN macro
MUSES/Prism	2	User reader from Thermoanalytics
NCC	2	User reader interface to National Combustion Code, contact CEI for info
N3S	1	Direct reader for the EDF code N3S
NetCDF	1	User reader, contact CEI for information
NSMB	2	User reader developed by CERFACS and CSCS
NSU2D / NSU3D	4	Contact CEI for information
PAM-FLOW	2	User-defined reader from ESI for native PAM-FLOW files
PHOENICS	1	Use PLOT3D file/reader, contact CEI for information
PLOT3D	1	Direct reader for PLOT3D and FAST structured formats
POLY-3D	3	Contact vendor for information
POLYFLOW	4	Outputs EnSight Case format
POWERFLOW	3	Contact CEI for information on interfaces available
PERMAS	1	User-defined BIF/BOF reader (see Medina BIF/BOF)
PRESTO	1	Use Exodus II reader
PRONTO	1	Use Exodus II reader
PXI	1	User reader for Parallel Exodus Interface format
RADIOSS	1	User-defined reader
RADTHERM	2	User reader from Thermoanalytics
RESCUE	2	User reader for Schlumberger reservoir modeling framework, contact CEI for information
SCRYU	1	User reader
SC/TETRA	4	Exports EnSight Casefile format.
SILO	1, 3	Reads various formats supported by SILO API
SPHINX	4	Code exports EnSight format
STAR-CD (Version 3.0.5 & up)	4	Code exports EnSight Casefile format (including particle data)
STL	1	User reader for STL geometry files (may also be exported)
SUPERFORGE		Contact CEI
TAHOE	4	Contact CEI for information on interfaces available
TECPLOT	1	User reader for TECPLOT 7 structured and unstructured formats
TECPLOT_ASCII	1	User reader for TECPLOT 10 ASCII
Telluride	4	Code exports EnSight format
UNCLE	2	User reader, contact CEI for details
UNIC-CFD	3	Contact vendor for details
USM3D	4	From TetrUSS code. Contact CEI for information
VECTIS	1, 3	User reader

*Geometry*

EnSight reads unstructured and structured geometric data grouped by parts. Data can be 0D, 1D, 2D or 3D.

*Analysis Results*

EnSight reads scalar and vector variable values associated with each node and/or element of the geometry. The loading of variable values is optional, and variables can be unloaded to free memory.

*Measured Data*

EnSight can read measured or computed particles (referred to as discrete particles in EnSight). Particles can have the same variables as the model geometry, or their own variables. Particles can be displayed as points, crosses, or spheres whose size can vary according to a variable value. Sphere smoothness is also controllable. Discrete particles can be time dependent with the geometry, or time dependent with a steady geometry.

**(See EnSight Gold Measured/Particle File Format, in Section 11.1)**

*Cases* EnSight provides the capability to read and manipulate up to sixteen datasets or models at a time. Each new “Case” is handled by its own Server process while the Client appropriately deals with merged variables, solution times, etc. This option allows both the recombination of models partitioned for parallel analysis and a number of comparative operations.

## Graphical Environment

Parts are visualized in a main Graphics Window. You can create additional viewports and adjust their size to your needs. Each viewport has its own transformations (global, local, look-at, look-from, and Z-clip locations). Part visibility is also controllable in each viewport.

A separate “Show Selected Part(s)” window helps in identifying parts.

*Hidden Lines and Shaded Surfaces* You can choose to shade surfaces and/or hide hidden lines for realistic views of your model. Visible element edges can be overlaid on shaded solid images.

*Clipping* In addition to user-control of the front and back visual clipping planes of your workspace, you can visually cutaway parts or portions of parts along any plane using Auxiliary Clipping. Individual parts can be made immune to the effect, enabling you to look at parts inside of other parts.

*Annotations* EnSight can display text-strings, lines, arrows, logos, entity labels, and color-map legends. Text annotations (which may include variables) can be made to automatically update for time-dependent data.

*Image Output* Screen images can be saved from within EnSight. Conversion to popular formats is under user control as the image is saved.

*Perspective* You have your choice of a perspective view or an orthogonal view. The latter is useful for comparing the position of parts and positioning EnSight tools.

*Background Color or Image* You can specify a constant or blended color background for the main Graphics Window and independently for any Viewports displayed in the Graphics Window. You can also use a .xpm or .bmp image as the background.

## Transformations

The standard transformations of rotate, translate, and scale are available, as well as positioning of the Look-At and Look-From points. An automatic zoom control is available. The transformation-state (the specific view in the Graphics Window and Viewports) can be saved for later recall and use. Transformations can be performed with precision in a dialog, or interactively with the mouse. For the latter case, you can choose to represent the parts with bounding-boxes (or by points only or reduced elements) all the time or only while they are moving. Transformations can individually be reset by type.

(see [Chapter 9, Transformation Control](#))

## Frames

Transformations actually apply to frames—the parts attached to the frames transform right along with their frame. You can create new frames and transform them like parts (in a dialog or with the mouse), and change to which frame a part is attached. You control whether and how frames are displayed, enabling you to use them as rulers. Frames can have rectangular, cylindrical, or spherical coordinates.



Frames, and therefore all parts attached to them, can be “periodic”. Rotational or translational periodicity (as well as mirror symmetry) attributes are under user control allowing, for example, an entire pie to be built from one slice of the pie.

(see [Section 8.5, Frame Mode](#) and [Section 9.3, Frame Transform](#))

## Coloration

Parts can be constant colored or colored according to the value of a variable. This feature works for both lines and surfaces. The coloration of each part is an attribute of that part.

### *Variable Palettes*

You control the value-color correspondence with a *palette*. A palette’s scale can be linear, logarithmic, or exponential. Palettes can have a continuous range of colors, or color bands. Off-the-scale parts or portions of parts can be made invisible.

(see [Section 4.2, Variable Summary & Palette](#))

## Created Parts

In addition to the *model parts* defined in the dataset, you can (and usually will) define additional *created parts* based on both the geometry *and* variable-values of existing *parent-parts*. Model parts and most kinds of created parts can be used as parent parts. Created parts have their own part attributes, including the *creation attributes* that define them, but *remain dependent upon their parent-parts*. A created part *automatically regenerates* if any of its parent-parts are changed in a way that will affect its representation.

### *Clips*

A clip is a plane, line, box, ijk surface, xyz plane, rtz surface, quadric surface (cylinder, sphere, cone, etc.), or revolution surface passing through specified parent-parts. The plane clip can either be limited to a specific area (finite), or clip infinitely through the model. A line clip is finite and most other clips are infinite in nature. You control the location of the various clips with an interactive Tool or appropriate parameter or coefficient input.

A clip line has query points along the line (you control how many).

A clip plane will either be a true clip through the model, or can be made to be a grid where the grid density is under your control.

Clip surfaces can be animated as well as manipulated interactively.

In most cases you will create a clip which is the intersection of the clip tool and the parent parts. This clip can either be a true intersection or all elements that cross the intersection surface (a “crinkly” surface). You can also choose to cut the parent parts into half spaces.

(see [Section 7.9, Clip Create/Update](#))

### *Contours*

Contours are created by specifying which parts are to be contoured, and which variable to use. The contour levels can be tied to those of the palette or can be specified independently by the user.

(see [Section 7.7, Contour Create/Update](#))

### *Developed Surfaces*

Developed Surfaces can be created from cylindrical, spherical, conical, or revolution clip surfaces. You control the seam location and projection method that will flatten the surface.

(see [Section 7.20, Developed Surface Create/Update](#))

- Elevated Surfaces*      Elevated Surfaces can be displayed using a scalar variable to elevate the displayed surface of specified parts. The elevated surface can have side walls.  
(see [Section 7.14, Elevated Surface Create/Update](#))
- Isosurfaces*              Isosurfaces can be created using a scalar, vector component, vector magnitude, or coordinate. Isosurfaces can be manipulated interactively or animated by incrementing the isovalue.  
(see [Section 7.8, Isosurface Create/Update](#))
- Particle Traces*          Particle traces—both streamlines (steady state) and pathlines (transient)—trace the path of either a massless or massed particle in a vector field. You control which parts the particle trace will be computed through, the duration of the trace, which vector variable to use during the integration, and the integration time-step limits. Like other parts, the resulting particle trace part has nodes at which *all* of the variables are known, and thus it can be colored by a different variable than the one used to create it. Components of the vector field can be eliminated by the user to force the trace to, for example, lie in a plane. The particle trace can either be displayed as a line, a ribbon, or a square tube showing the rotational components of the flow field. Streamlines can be computed upstream, downstream, or both.  
  
Particle traces originate from *emitters*, which you create. An emitter can be a point, rake, net, or can be the nodes of a part. Each emitter has a particle trace emit time specified which you set, and a re-emit time (if the data case is transient) can also be specified. Point, rake, and net emitters can be interactively positioned with the mouse. For streamlines, the particle trace continues to update as the emitter tool is positioned interactively by the user.  
(see [Section 7.11, Particle Trace Create/Update](#))
- Profiles*                  Profile plots can be created by scalar, vector component, or vector magnitude. You control the orientation of the resulting profile plot.  
(see [Section 7.13, Profile Create/Update](#))
- Subsets*                  A subset Part can contain node and element ranges of any model Part.  
(see [Section 7.12, Subset Parts Create/Update](#))
- Vector Arrows*          Vector arrows show the direction and magnitude of a vector field. Vector arrows originate from element vertices, element nodes (including mid-side nodes), or from element centers. You specify which parts are to have arrows and which vector variable to use for the arrows, as well as a scale factor. You can eliminate components of the vector, and can also filter the arrows to eliminate high, low, low/high, or banded vector arrow magnitudes. The vector arrows can be either straight or curved, and can have arrow heads. The arrow heads are either proportional to the arrow or can be of fixed size.  
(see [Section 7.10, Vector Arrow Create/Update](#))
- Tensor Glyphs*          Tensor glyphs show the direction of the principal eigenvectors. You specify which eigenvectors you wish to view and how you wish to view compression and tension.  
(see [Section 7.21, Tensor Glyph Parts Create/Update](#))
- Vortex Cores*              Vortex cores show the center of swirling flow in a flow field.  
(see [Section 7.15, Vortex Core Create/Update](#))

*Shock Surfaces/  
Regions*

Shock surfaces or regions show the location and extent of shock waves in a 3D flow field.

(see [Section 7.16, Shock Surface/Region Create/Update](#))

*Separation/  
Attachment Lines*

Separation and attachment lines show where flow abruptly leaves or returns to the 2D surface in 3D fields.

(see [Section 7.17, Separation/Attachment Lines Create/Update](#))

**Queries**

In addition to visualizing information, you can make numerical queries.

You can query on information for a node, point, element, or a part.

You can query on information for a data set (such as size, no. of elements, etc.)

You can query scalar and vector information for a point or node over time.

You can query scalar and vector information along a line. The line can either be a defined line in space, or a logical line composed of multiple 1D elements for a part (for example query of a variable on a particle trace).

You can query to find the spatial or temporal mean as well as the min/max information for a variable.

Where applicable, query information can be in the form of a Fast Fourier Transform (FFT).

*Plotting*

The plotter plots Y vs. X curves. The user controls line style, axis control, line thickness and color. All query operations that result in multiple value output in EnSight can be sent to the plotter for display. The user can control which curves to plot. Multiple curve plots are possible. All plotable query information can be saved to a disk file for use with other plotting packages.

(see [Section 7.5, Query/Plot](#) and [Section 7.6, Interactive Probe Query](#))

*Variable Creation*

New information can be computed resulting in a constant, a scalar, or a vector. EnSight includes useful built-in functions for computing new variables:

Area	Boundary Layer Cf Wall
Boundary Layer Displ Thickness	Boundary Layer Dist to Value fr Wall
Boundary Layer Momentum Thickness	Boundary Layer Thickness
Boundary Layer Y1 Plus off Wall	Case Map
Coefficient	Complex from real and imaginary
Complex Argument	Complex Conjugate
Complex Imaginary	Complex Modulus
Complex Transient Response	Complex Real
Curl	Density
Density, Normalized	Density, Stagnation
Density, Normalized Stagnation	Density, Log of Normalized
Distance Between 2 Nodes	Divergence
Element to Node	Energy, Total
Energy, Kinetic	Enthalpy
Enthalpy, Normalized	Enthalpy, Stagnation
Enthalpy, Normalized Stagnation	Entropy
Flow	Flow Rate
Fluid Shear Stress	Fluid Shear Stress Max

Force	Force1D
Gradient	Gradient Approximation
Gradient Tensor	Gradient Tensor Approximation
Helicity Density	Helicity, Relative
Helicity, Relative Filtered	Iblanking Values
Integral, Line	Integral, Surface
Integral, Volume	Length
Mach Number	Make Element Scalar
Make Nodal Scalar	Make Vector
Mass Flux Average	Mass Particle Scalar
Max	Min
Moment	
Moment Vector	Momentum
Node to Element	Normal
Normal Constraints	Normalize Vector
Offset Field	Offset Variable
Pressure	Pressure Coefficient
Pressure, Dynamic	Pressure, Normalized
Pressure, Log of Normalized	Pressure, Pitot
Pressure, Pitot Ratio	Pressure, Stagnation
Pressure, Normalized Stagnation	Pressure, Stagnation Coefficient
Pressure, Total	Rectangular to Cylindrical Vector
Shock Plot3d	Spatial Mean
Speed	Sonic Speed
Stream Function	Swirl
Temperature	Temperature, Normalized
Temperature, Stagnation	Temperature, Normalized Stagnation
Temperature, Log of Normalized	Temporal Mean
Tensor Component	Tensor Determinate
Tensor Eigenvalue	Tensor Eigenvector
Tensor Make	Tensor Make Asymmetric
Tensor Tresca	Tensor Von Mises
Velocity	Volume
Vorticity	

A calculator and built-in math functions also are useful for creating variables. Any created variable is available throughout EnSight, and is automatically recomputed if the user changes the current time (in case of transient data).

(see [Section 4.3, Variable Creation](#))

In addition to the built-in general functions and the calculator options, variables can be derived from user written external functions called User Defined Math Functions (UDMF). The UDMF's appear in EnSight's calculator in the general function list and can be used just as any calculator function.

Another feature of EnSight facilitates the creation of boundary layer variables.

(see [Section 7.18, Boundary Layer Variables Create/Update](#))

## Transient Data

EnSight handles transient (time dependent) data, including changing connectivity for the geometry. You can easily change between time steps via the user interface. All parts that are created are updated to reflect the current display time (you can override this feature for individual parts). You can change to a defined time step, or change to a time between two defined steps (EnSight will linearly interpolate between steps), though the “continuous” option is only available for cases without changing connectivity.

## Animation

You can animate your model in four ways: particle trace animation, flipbook animation, solution time streaming, and keyframe animation.

### *Particle Trace Animation*

Particle trace animation sends “tracers” down already created particle traces. You control the color, line type, speed and length of the animated traces.

If transient data is being animated at the same time, animated traces will automatically synchronize to the transient data time, unless you specifically indicate otherwise.

### *Flipbook Animation*

A Flipbook animation reads in transient data step by step or moves a part spatially through a series of increments and stores the animation in memory. Playback is much faster as it is from memory rather than disk, but the trade-off is that Flipbook Animation can fill up your client memory. Flipbook animation is simpler to do than keyframe animation, while allowing four common types of animation:

- Sequential presentation of transient data

- Mode shapes based on a displacement variable

- EnSight created parts with an animation delta that recreates the part at a new location (i.e., moving isosurfaces and Clip surfaces).

- Sequential displacement by linear interpolation from zero to maximum vector value.

You can specify the display speed, and can step page-by-page through the animation in either direction. You can load some, or all the desired data. If you later load more data, you can choose to keep the already loaded data. With transient data, you can create pages between defined time steps, with EnSight linearly interpolating the data.

Flipbooks can be created in two formats: a) Object animation where new objects are created for each time step. The user can then manipulate the model during animation play back or b) Image animation where a bitmap of the Main View image is created and stored off for each animation page. For large models, image animation can sometimes take less memory - while trading off the capability to manipulate the model during animation.

(see [Section 7.2, Flipbook Animation](#))

### *Solution Time Streaming*

Solution time streaming accomplishes the same result as a flipbook animation of transient data except the data is never loaded into memory: it is streamed directly from disk. While you don't see the animation speed of a flipbook, you only need enough memory to load in one step at a time.

### *Keyframe Animation*

Keyframe animation performs linearly interpolated transformations between specified key frames to create animation frames. Command language can be

executed at key frames to script your animation. Some minimal editing is possible by deleting back to defined key frames. Animation key frames can be saved and restored from disk. Animation can be done on transient data and can automatically synchronize with simultaneous flipbook animation and particle trace animation.

“Fly-around”, “rotate-objects”, and “exploded-view” quick animations are predefined for easy use.

Keyframe animation can be recorded to disk files using a format of your choice.

(see [Section 7.3, Keyframe Animation](#))

## Implementation

### *Interface*

EnSight uses the OSF/Motif graphical user interface conventions for the Unix version and Win32 conventions under the Windows 2000/XP operating system. Many aspects of the interface can be customized.

### *Client-Server*

EnSight is a *distributed application*—it runs as separate processes that communicate with each other via a TCP/IP or similar connection. The *Server* performs most CPU-intensive and data-handling functions, while the *Client* performs the graphics-display and user-interface functions. The Client and Server can run together on one host workstation in a “stand-alone” installation or on two host systems with each hardware system performing the functions it does best. When more than one case is loaded the Client communicates with multiple Server processes.

### *Server-of-Servers*

A special server-of-servers (SOS) can be used in place of a normal server if you have partitioned data. This SOS acts like a normal server to the client, but starts and deals with multiple servers, each of which handle their portion of the dataset. This provides significant parallel advantage for large datasets.

(see [Section 11.8, Server-of-Server Casefile Format](#))

### *Virtual Reality*

EnSight is fully capable of running multi-pipe display, virtual reality and distributed rendering modes.

(see [Section 13, Parallel Rendering and Virtual Reality](#))

### *Command Language*

Each action performed with the graphical user interface has a corresponding EnSight command. A session file is always being saved to aid in recovery from a mistake or a program crash. The user will be prompted upon restart, after a crash, whether or not to use a recovery file to restore the session. The command language is human-readable and can easily be modified. Command files can be played all the way through, or you can choose to stop the file and step through it line-by-line.

### *Context Files*

You can define a “context” and apply it to similar datasets.

### *Graphics Hardware*

Many graphics functions of EnSight are performed by your workstation’s graphics hardware. EnSight version 8 uses the OpenGL graphic libraries and is available on a multitude of hardware platforms.

Solid image lighting can be done either in hardware, or in software. The software option does not recalculate the lighting changes due to transformations (hence, the light source seems to move with the model). While this is less realistic, it can greatly increase performance and decrease memory requirements.

Parallel Computation	EnSight supports shared-memory parallel computation via POSIX threads. Threads are used to accelerate the computation of streamlines, clips, isosurfaces, and other compute-intensive operations. (See <a href="#">How To Setup for Parallel Computation</a> for details on using.)
<i>Macros</i>	You can define macros tied to mouse buttons or keyboard keys to automate actions you frequently perform.
<i>Saving and Archiving</i>	You can save the entire current status of EnSight for later use, and can save other entities as well (including the geometry of created parts for use by your analysis software).  (see <a href="#">Section 2.6, Archive Files</a> )
Documentation	The printed EnSight documentation consists of the Installation Guide.  The on-line EnSight documentation consists of the EnSight Getting Started Manual, How To Manual, User Manual, and a Command Language Reference Manual. The online documentation is available via the Help menu.
<i>User Manual</i>	The EnSight User Manual is organized as follows:  <b>User Manual Table of Contents</b>  <b>Chapter 1 - Overview</b>  <b>Chapter 2 - Input/Output.</b> This chapter describes the reading of model data (with internal or user-defined readers), command files, archive files, context files, scenario files, and various other input and output operations.  <b>Chapter 3 - Parts.</b> This chapter describes the various types of Parts, selection, identification, and editing of Parts, and various Part operations,  <b>Chapter 4 - Variables.</b> This chapter describes the selection and activation of variables, color palettes, and the creation of new variables.  <b>Chapter 5 - GUI Overview.</b> This chapter describes the EnSight Graphic User Interface.  <b>Chapter 6 - Main Menu.</b> This chapter describes the features and functions available through the buttons and pull-down menus of the Main Menu of the GUI.  <b>Chapter 7 - Features.</b> This chapter describes the features and functions available through the Icon buttons of the Feature Icon Bar of the GUI.  <b>Chapter 8 - Modes.</b> This chapter describes the features and functions available through the Icon Buttons of the Mode Icon Bar in the six different Modes.  <b>Chapter 9 - Transformation Control.</b> This chapter describes the Global transformation of all Frames and Parts, the transformation of selected Frames and Parts as well as selected Frames alone, the transformation of the various Tools, and the adjustment of the Z-Clip planes and the Look At and Look From Points.  <b>Chapter 10 - Preference File Formats.</b> This chapter describes the format of various preference files which the uses can affect.  <b>Chapter 11 - EnSight Data Formats.</b> This chapter describes in detail the format of the various EnSight data formats.  <b>Chapter 12 - Utility Programs.</b> This chapter describes a number of unsupported utility programs distributed with EnSight.  <b>User Manual Index</b>

Cross References in the User Manual will appear similar to:

(see Chapter \_\_ or (see Section \_\_

Clicking on these Cross References will automatically take you to the referenced Chapter or Section.

*Command  
Language Reference  
Manual*

This manual describes each command of EnSight's command language.

*How To...*

The various How To documents available on-line provide step-by-step, click by click instructions explaining how to perform tasks within EnSight such as creating an isosurface or reading in data.

*Ordering*

To order copies of EnSight documentation, contact CEI by telephone at the numbers listed below or email [ensight@ensight.com](mailto:ensight@ensight.com)

*Newsletter*

CEI periodically publishes an EnSight newsletter, called the EnSight Post. If you would like to receive the newsletter, see our website:

[www.ensight.com](http://www.ensight.com).

## Contacting CEI

EnSight was created to make your work easier and more productive. If you have any questions about or problems using EnSight, or have suggestions for improvements, please contact CEI support:

Phone: (800) 551-4448 (USA)  
(919) 363-0883 (Outside-USA)  
Fax: (919) 363-0833  
Email: [support@ensight.com](mailto:support@ensight.com)



# 2 Input

This chapter provides information on data input and output for EnSight.

**2.1 Reader Basics** provides a detailed description of the basics for reading data. This section is referenced by all formats, in that they all use some or all of these basic procedures. The quick load, as well as the more flexible two step load process is discussed for both unstructured and structured data formats.

**2.2 Native EnSight Format Readers** describes the specifics for reading the EnSight formats.

**2.3 Other Readers** describes the specifics for reading many other formats into EnSight. These can be internal or user-defined readers.

**2.4 Other External Data Sources** describes other ways in which model data can be prepared to be read into EnSight.

**2.5 Command Files** provides a description of the files that can be saved for operations such as automatic restarting, macro generation, archiving, hardcopy output, etc.

**2.6 Archive Files** describes options for saving and restoring the entire current state of the program.

**2.7 Context Files** describes the options for saving and restoring context files.

**2.8 Scenario Files** describes the options for saving scenario files that can be displayed in the EnLiten program.

**2.9 Saving Geometry and Results Within EnSight** describes how to save model data, from any format which can be read into EnSight, as EnSight gold casefile format.

**2.10 Saving and Restoring View States** describes options for saving and restoring given view orientations.

**2.11 Saving and Printing Graphic Images** describes options for saving and printing graphic images.

**2.12 Saving and Loading XY Plot Data** describes options for saving and loading xy plot data.

**2.13 Saving and Restoring Animation Frames** describes options for saving and restoring flipbook and keyframe animation frames.

**2.14 Saving Query Text Information** describes options for saving query information to a text file.

**2.15 Saving Your EnSight Environment** describes options for saving various environment settings which affect EnSight.

*Note: Formats for EnSight related files are described in chapters 10 and 11. Formats for the various Analysis codes are not described herein.*

## 2.1 Reader Basics

### Dataset Format Basics

#### Reading and Loading Data Basics

#### Dataset Format Basics

EnSight is designed to be an engineering postprocessor, and supports data formats for popular engineering simulation codes and generally used data formats. Yet its many features can be used in other areas as well. EnSight has been used to visualize and animate results from simulations of diesel combustion, cardiovascular flow, petroleum reservoir migration, pollution dispersion, meteorological flow, as well as results from many other disciplines.

EnSight reads node and element definitions from the geometry file and groups elements into an entity called a *Part*. A Part is simply a group of nodes and elements (the Part can contain different element types) which all behave the same way within EnSight and share common display attributes (such as color, line width, etc.).

EnSight allows you to read multiple datasets and work with them individually in the same active session. Each dataset comprises a new “Case” and is handled by its own Server process. Note: if the client and the server are each on different computers, then the data directory path is that seen from the server.

#### Reading and Loading Data Basics

Reading and then Loading Data into EnSight is either a one-step quick load or a two step process.

##### Quick Load

The one-step quick load is accomplished from the menu, `Main Menu > File > Open...` and then the file is selected and read by EnSight to the Server, and then all parts are loaded into the Client. This is quick but it does not allow control of which parts to load, nor does it control their visual representation. Also, quick load only works for files mapped in the `ensight_reader_extension.map` file found in the `.ensight8` directory.

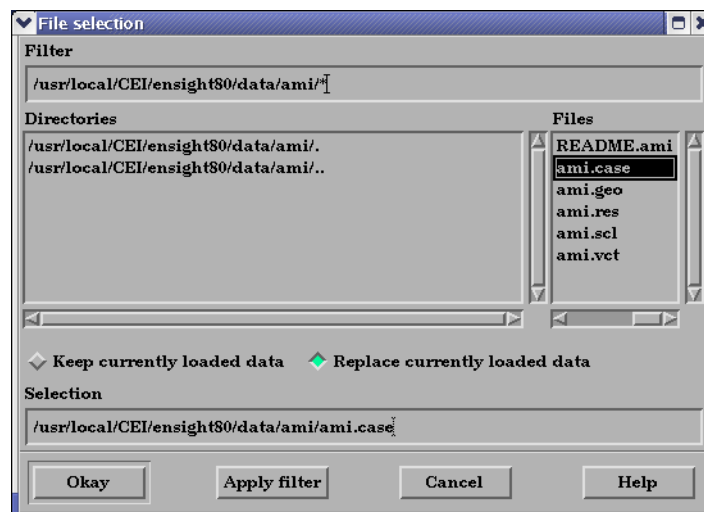

Figure 2-1  
File Open dialog

Filter	This field specifies the directory name that your data files reside in. Enter a “/*” at the end of the name to list all of the files and directories contained there. To filter to a smaller file list you can be more specific by entering Parts of the file names, such as “./my*” which will list all files and directories starting with “my” in the current directory. If you only enter a “/”, then only the directories in the current working directory will be listed. To apply the Filter, click the Apply Filter button (or just hit return with your cursor in the Filter field) and the Directories and matching Files lists will be updated and the directory will be listed in the Selection field below as the current selection.
Directories	Selection of directories available to use in the current directory. Single click to place the directory string in the Filter field. Double click to use the directory as the filter (same effect as clicking once and then clicking Apply Filter button), the Directories and Files lists will be updated and the directory will be listed in the Selection field below as the current selection. The sliding controls to the right and bottom of the list let you view all available directories. Double click the “..” directory to change the default filter directory up one level.
Files	Single click to select a file. This will insert the file name after the directory listed in the Selection field. This list contains all unfiltered files that are in the filter directory. Note, double-clicking a file behaves as if you’ve selected the file and clicked Okay.
Keep current	Toggle the “Keep currently loaded data” to load the current data set in addition to the one already loaded. Note: if you are running the client and server separately (manually connected) then you will be asked to start up a new server.
Replace current	Toggle the “Replace currently loaded data” to replace the existing dataset with the new one. Note: if you are running the client and server separately (manually connected) then the existing server process will be disconnected and you will be asked to start up a new server.
Selection	File or directory selected. Click the Okay button to use information in this field.
Okay	Click to read the files specified in the Selection field and close the File Selection dialog.
Apply filter	Click to apply the string in the Filter field.
Cancel	Click to close the File Selection dialog without reading the files specified in the Selection field.

(For a step-by-step tutorial please see [How To Read Data](#)).

**Two Step Load**  
Data Reader

The two-step load first involves the Data Reader (Main Menu > File > Data (reader) . . .) where the data path is navigated, and filename(s), data format, and other parameters are entered as required. Click Okay to go to the second step in the load process, the Data Part Loader.

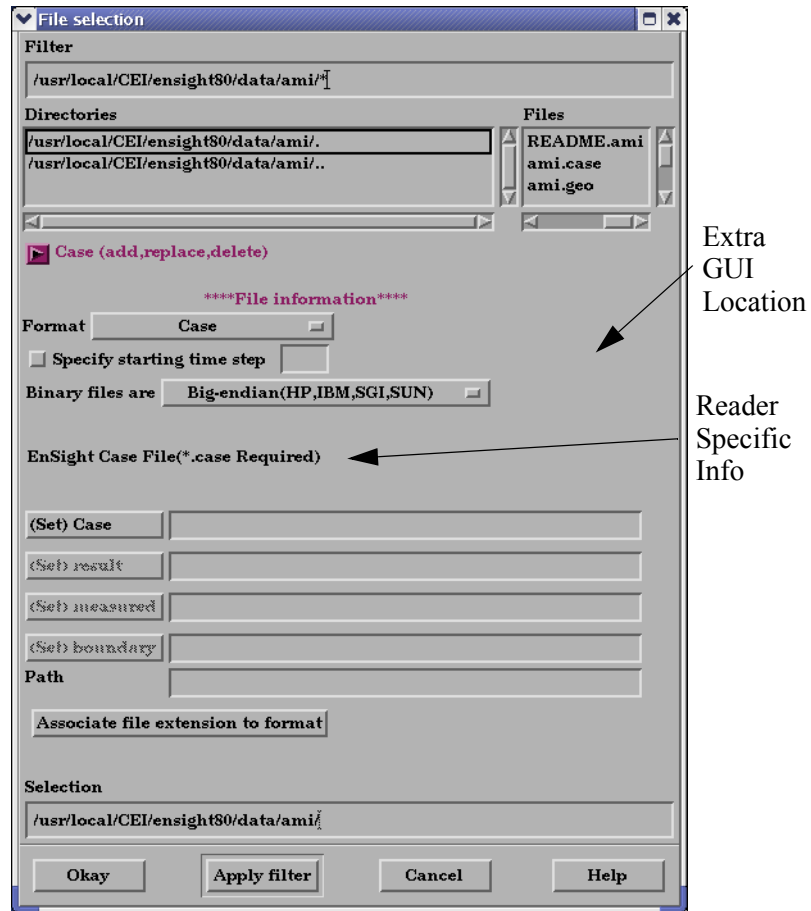

Figure 2-2  
File Data Reader dialog

- Filter**

This field specifies the directory name that your data files reside in. Enter a “/” at the end of the name to list all of the files and directories contained there. To filter to a smaller file list you can be more specific by entering Parts of the file names, such as “.my\*” which will list all files and directories starting with “my” in the current directory. If you only enter a “.”, then only the directories in the current working directory will be listed. To apply the Filter, click the Apply Filter button (or just hit return with your cursor in the Filter field) and the Directories and matching Files lists will be updated and the directory will be listed in the Selection field below as the current selection.
- Directories**

Selection of directories available to use in the current directory. Single click to place the directory string in the Filter field. Double click to use the directory as the filter (same effect as clicking once and then clicking Apply Filter button), the Directories and Files lists will be updated and the directory will be listed in the Selection field below as the current selection. The sliding controls to the right and bottom of the list let you view all available directories. Double click the “..” directory to change the default filter directory up one level.
- Files**

Single click to select a file. This will insert the file name after the directory listed in the Selection field. This list contains all unfiltered files that are in the filter directory. Note: Unlike the Quick Load Open..., double-click should not be used here.

Case	
Add...	This is not referring to Case file format. This is referring to adding an additional load case (an additional model dataset). Each load case uses one Server. Additional data (in Case format or other formats) can be read into another connected Server.
Replace...	Specify a new load case to replace an existing load case.
Delete	Delete an existing load case. Case 1 cannot be deleted, but it can be replaced.
Format	Specifies the Format of the dataset. This pulldown will vary depending upon what readers are installed at your local site, and what readers are made visible in your preferences. Note: you can start up ensight with the -readerdbg flag to view verbose information on the readers as they are loaded into EnSight.
Time Step	Specify starting time step. If not specified, EnSight will load the last step (or whatever step you have set in your preferences, see Edit>Preferences>Data).
Binary Files Are	This is typically checked automatically by the reader, and thus usually there is no need to use this toggle. If the file is binary, sets the byte order to: <i>Big-Endian</i> - byte order used for HP, IBM, SGI, SUN, NEC, and IEEE Cray. <i>Little-Endian</i> - byte order used for Intel and alpha based machines. <i>Native to Server Machine</i> - sets the byte order to the same as the server machine.
Extra GUI	The User-Defined Reader API includes routines to add Toggles, Text Fields, and Pulldown Menus that can allow the user to modify the reader behavior. Only a subset of the readers make use of this feature.
Reader-Specific Information	Helpful information that is reader-specific will appear here, such as what file types are entered into what fields.
(Set) Case or (Set) Geometry	If this button reads “(Set) Case” then the reader is looking for a .case file in the field. A .case file is an ASCII file that tells the reader the filenames of the geometry and results files. If the button reads “(Set) Geometry” then the reader is looking for a data file that is specific to that reader. Please consult the specific reader of interest to determine what to enter into this field. Clicking this button inserts the file name shown in the Files Selection field and inserts the path information into the Path field. File name can alternatively be typed into this field.
(Set) Result or (Set) Params	Depending upon the format, this field may or may not be available. If this button reads “(Set) Result” then the reader is looking for a filename containing the variable results for the model. If no filename is entered into this field, then no variable results are read from the file. If the button reads “(Set) Params” then the reader is checking for optional text which might consist of flags to control the reader behavior. Please consult the specific reader of interest to determine what to enter into this field. Clicking the button inserts the file name shown in Files Selection field and also inserts path information into Path field. File names can alternatively be typed into this field.
(Set) Measured	Name of a measured file. Measured data is read independently of the reader and is entered here for all readers except Case file format. For Case file format, this field is not used and the measured data filename is entered into the Case file. This is always an optional file. Clicking the button inserts the file name shown in Selection field and also inserts path information into Path field. File names can alternatively be typed into the field.
(Set) Boundary	Name of a boundary file. This field is used only for structured data in Case file, Plot3d, or Special HDF5, or other user-defined formats with structured data.
Path	Path to dataset location is inserted by clicking the (Set) buttons or may be entered. If blank, the files are read from the Server’s current working directory. Can use the tilde character (~) to specify home directory on the Server host system.
Associate File Extension	Choose a reader and a filename in the (Set) Geometry field, and click this button to associate that file extension to that reader. This button may not be available until a later release of EnSight 8.

## 2.1 Reading and Loading Data Basics

Selection	File or directory selected. Click the appropriate (Set) button to use information in this field.
Okay	Click to read the files specified in the (Set) fields and close the File Selection dialog.
Apply Filter	Click to apply the string in the Filter field.
Cancel	Click to close the File Selection dialog without reading the files specified in the (Set) fields.

(For a step-by-step tutorial please see [How To Read Data](#))

**Two Step Load Data Part Loader** The second step of the two step load, involves the Data Part Loader where the parts to be loaded onto the Client, as well as their new name (if desired) and representation are chosen. There are two basic part loader windows. Details of these windows will be discussed below, and variants from these windows will be discussed under each specific reader format.

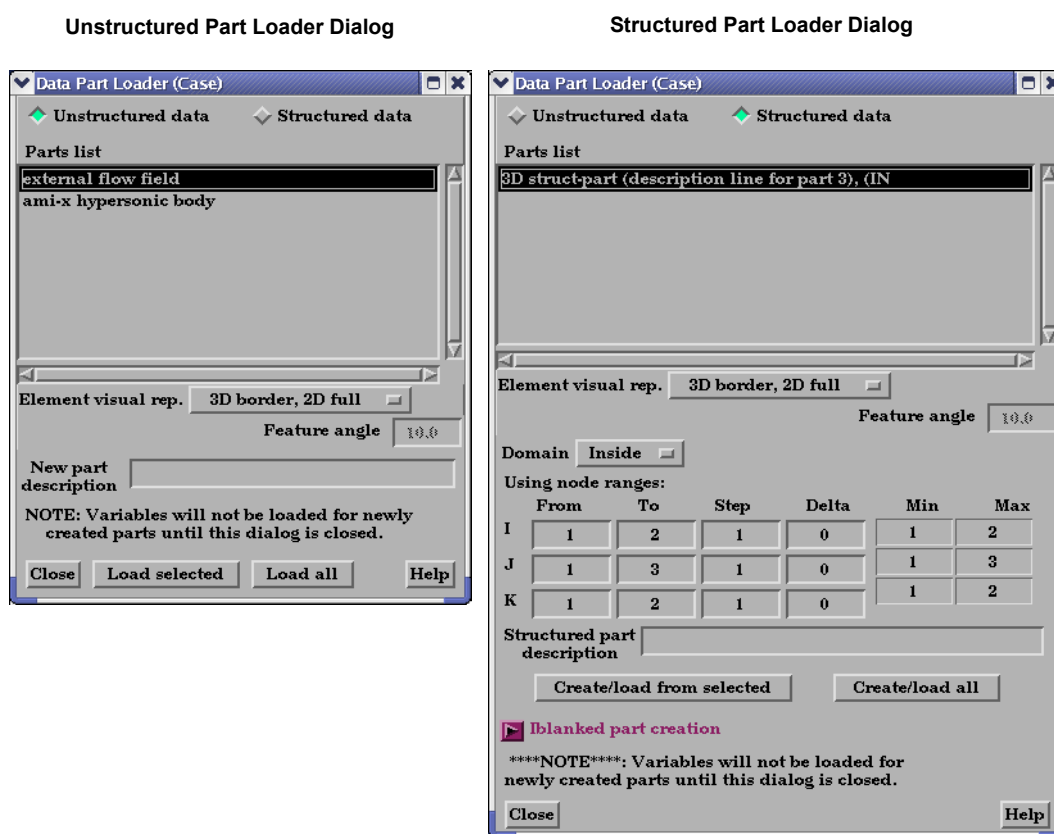

Figure 2-3  
Typical File Data Part Loader dialogs

All Parts or some of those available on the Server may be loaded to the Client and their visual representation can be chosen. The Data Part Loader may be reopened at a later time and additional or duplicate parts loaded as desired.

<i>Unstructured Data</i>	This toggle indicates that the Part(s) listed in the Part List is(are) unstructured.
<i>Structured Data</i>	This toggle indicates that the Part(s) listed in the Part List is(are) structured.
<i>Parts List</i>	Lists all Parts in the data files which may be loaded to the Server (and subsequently to the Client). Some formats such as EnSight6 or EnSight Gold data can have unstructured, structured, or both types of Parts.

**Element Visual Rep.**

Parts are defined on the server as a collection of 0, 1, 2, and 3D elements. EnSight can show you all of the faces and edges of all of these elements, but this is usually a little overwhelming, thus EnSight offers several different *Visual Representations* to simplify the view in the graphics window. Note that the Visual Representation only applies to the EnSight client—it has no affect on the data for the EnSight server.

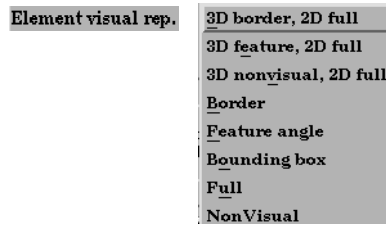

Figure 2-4

Element Visual Representation pulldown

3D Border, 2D Full	In this mode, load the designated parts, show all 1D and 2D elements, but show only the unique (non-shared) faces of 3D elements.
3D Feature, 2D Full	In this mode, load the designated parts, but show the 3D elements in Feature Angle mode (see Feature below), and show all of the 1D and 2D elements.
3D nonvisual, 2D full	In this mode load the 3D parts but do not display them in the graphics window (see Non Visual below) and load all the 1D and 2D elements.
Border	In Border mode all 1D elements will be shown. Only the unique (non-shared) edges of 2D elements and the unique (non-shared) faces of 3D elements will be shown.
Feature Angle	When EnSight is asked to display a Part in this mode it first calculates the 3D Border, 2D Full representation to create a list of 1D and 2D elements. Next it looks at the angle between neighboring 2D elements. If the angle is above the Angle value specified in the Feature Angle Field, the shared edge between the two elements is retained, otherwise it is removed. Only 1D elements remain on the EnSight client after this operation.
Bounding Box	All Part elements are replaced with a bounding box surrounding the Cartesian extent of the elements of the Part.
Full	In Full Representation mode all 1D and 2D elements will be shown. In addition, all faces of all 3D elements will be shown.
Non Visual	This specifies that the loaded Part will not be visible in the Graphics Window because it is only loaded on the Server. Visibility can be turned on later by changing the representation (at which time the elements of the selected representation will be sent to the client).
<b>Part Description</b>	This allows the user to name the part. If nothing is entered here, then the part is named from the partlist.
<b>Load Selected</b>	Loads Parts selected in the Parts List to the EnSight Server. The Parts are subsequently loaded to the EnSight Client using the specified Visual Representation. If Non Visual is specified, the selected Parts will be loaded to the Server, but not to the Client.
<b>Load All</b>	Loads all Parts in the Parts List to the EnSight Server. The Parts are subsequently loaded to the EnSight Client using the specified Visual Representation. If Non Visual is specified, the selected Parts will be loaded to the Server, but not to the Client.

**Structured Data**

**Domain** Specifies the general iblanking option to use when creating a structured Part. If the model does not have iblanking, InSide will be specified by default.

- Inside* Iblank value = 1 region
- Outside* Iblank value = 0 region
- All* Ignore iblanking and accept all nodes

**Using Node Ranges:**

**From IJK** Specifies the beginning I,J,K values to use when extracting the structured Part, or a portion of it. Must be  $\geq$  Min value.

**To IJK** Specifies the ending I,J,K values to use when extracting the structured Part, or a portion of it. Must be  $\leq$  Max value.

Valid values for the From and To fields can be positive or negative. Positive numbers are the natural 1 through Max values. Negative values indicate surfaces back from the max, so -1 would be the max surface, -2 the next to last surface etc. There are therefore two ways to indicate any of the range values; the positive number from the min towards the max, or the negative number from the max toward the min. The negative method is provided for ease of use because of varying max values per part. (Zero will be treated like a -1, thus it is another way to get the max surface)

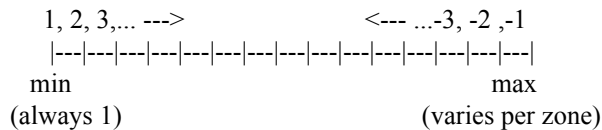

**Step IJK** Specifies the step increment through I,J,K. A Step value of 1 extracts all original data. A Step value of 2 extracts every other node, etc. Thus step values greater than 1 give a coarser resolution.

**Delta IJK** Specifies the delta to use when creating more than one surface from the same ijk part. Only one of the directions may be non-zero. *Note that an unstructured part is the result of any non-zero delta values.*

**Min IJK** Minimum I,J,K values for Part chosen (for reference).

**Max IJK** Maximum I,J,K values for Part chosen (for reference).

**Part Description** Text field into which you can enter a description for the Part. If left blank a default will be used.

**Create And Load Part** Extracts the data from the data files and creates a Part on the Server (and on the Client unless NonVisual has been specified for Representation) based on all information specified in the dialog.

If only one part is highlighted, the values shown in the From and To fields (as well as the Min and Max fields) are the actual values for the selected part. Using the From and To fields you can control whether an EnSight part will be created using the entire ijk ranges or some subset of them. The Step field allows you to sample at a more coarse resolution. And the Delta field allows for multiple “surfaces” in a given part (like blade rows of a jet engine). Please note that use of a non-zero delta produces an unstructured part instead of a structured one.

If more than one Part is highlighted, the values shown in the From and To fields are the combined bounding maximums of the selected parts. The same basic functionality described for a single part selection applies for multiple part selection, with one part being created for each selected part in the dialog. If the specified ranges for the multiple



selection exceed the bounds of a given part, they are modified for that part so that its bounds are not exceeded.

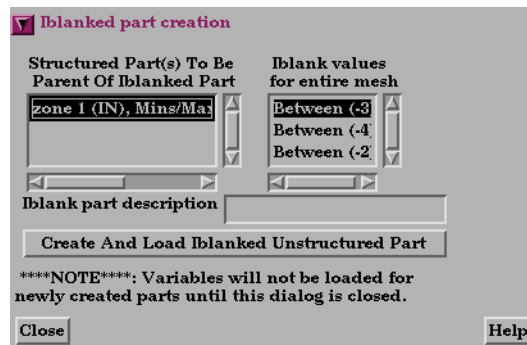

Figure 2-5

Iblanked Part Creation Section of Structured Part Loader dialog

You use this portion of the Part Loader dialog to further extract iblanked regions from structured parts which were created either as inside, outside, or all portions of the model.

*Structured Part(s)  
To Be Parent of  
Iblanked Part*

Lists all structured parts that have been created thus far in the dialog above.

*Iblank Values For  
Entire Mesh*

Lists all possible iblank values found in the model. This is a global list and may not apply to all parts.

*Iblank Part  
description*

Text field into which you can enter a part name for the iblanked part.

*Create And Load  
Iblanked  
Unstructured Part*

Extracts a new iblanked part from an existing structured part. This new part will actually be an unstructured part.

(For step-by-step instructions see [How To Read Data](#))

### Loading Tips

For large datasets, you should try to reduce the amount of information that is being processed in order to minimize required memory. Here are some suggestions:

- When writing out data from your analysis software, consider what information will actually be required for postprocessing. Any filtering operation you can do at this step can greatly reduce the amount of time it takes to perform the postprocessing.
- For each Part you do load to the Client, a *representation* must be chosen. This visual representation can be made very simple (through the use of the Bounding Box or Feature Angle option, for example), or can be made more complex (by using the border or full elements). The more you can reduce the visual representation, the faster the graphics processing will occur on the Client (see Node, Element, and Line Attributes in [see Section 3.3, Part Editing](#)).
- Load to the Client only those Parts that you need to see. For example, if you were postprocessing the air flow around an aircraft you would normally not need to see the flow field itself and could load it non-visual, but you would like to see the aircraft surface and Parts created based on the flow field (which remains available on the Server).
- If you have multiple variables in your result file, activate only those variables you want to work with. When you finish using a variable, consider deactivating it to free up memory and thereby speed processing ([see Section 4.1, Variable Selection and Activation](#)).

## Troubleshooting Loading Data

Problem	Probable Causes	Solutions
Data loads slowly	Loading more Parts than needed	For some models, especially external fluid flow cases, there is a flow field Part which does not need to be visualized. Try loading this Part non-visual.
	Too many elements	Make sure the default element representation for Model Parts is set to 3D Border/2D Full before loading the data. In some cases it is helpful to set the representation to Feature Angle or 3D Feature 2D Full, before loading.
	Client is swapping because it does not have enough memory to hold all the Parts specified.	Try loading fewer Parts or installing more memory to handle the dataset size.
	Server is swapping because it does not have enough memory to hold all of the Parts contained in the dataset.	Install more memory in your Server host system, reduce the number of variables activated, or somehow reduce the geometry's size. (If you can get the data in, you can cut away any area not now needed. What is left can then be saved as a geometric entity and that new dataset used for future postprocessing.)
Error reading data	Incorrect path or filename	Reenter the correct information. Remember, the Path is on the server.
	Incorrect file permissions	Change the permissions of the relevant directories and files to be readable by you.
	Temporary file space is full	Temporary files are written to the default temporary directory or the directory specified by the environment variable TMPDIR for both the Client and Server. Check file space by using the command "df" and remove unnecessary files from the temporary directory or other full file systems.
	Format of the data is incorrect	Recheck the data against the data format definition. (Can use <a href="#">ens_checker</a> for EnSight6 or EnSight Gold format checking.)

Problem	Probable Causes	Solutions
EnSight format scalar (or vector) data loads, but appears incorrect. Often range of values off by some orders or magnitude.	Scalar (or vector) information not formatted properly in data file	Format the file according to examples listed under EnSight Variable Files ( <a href="#">see Chapter 11, EnSight Data Formats</a> ) (Can use <a href="#">ens_checker</a> for EnSight6 or EnSight Gold format checking.)
	Extra white space appended to one or more of the records	Check for and remove any extra white space appended to each record

## 2.2 Native EnSight Format Readers

EnSight's native data format is useful as a general data format for finite elements or structured data. EnSight has three native data formats (from oldest to newest, EnSight5, EnSight6 and EnSight Case Gold) which are well defined and well documented so that they can be easily interfaced to your analysis code. EnSight 5, which is now considered a legacy format, used a global geometry array and supported unstructured meshes only. EnSight 6 format again used a global geometry array but added support for structured meshes. EnSight Case Gold (often just called Case format) is the most recent (and recommended) format. Case Gold defines geometry on a part by part basis and uses element index for connectivity. Case Gold format is tuned to the EnSight internal data structure and is the fastest and most memory efficient format available for EnSight.

A dramatic speed up in performance can sometimes be realized simply by reading in data in the given format and saving it back out as Case Gold, then re-reading the data back in using the native Case Gold reader. However, a number of solvers now output data directly into the well-documented Case format. (see [Chapter 11, EnSight Data Formats](#)). The application `ens_checker` is included with EnSight to enable error checking of the Case and EnSight 6 formats output by third-party software.

Described below is the process for reading the latest (Case & EnSight 6) and the legacy (EnSight 5) native formats:

### **EnSight Case Reader**

### **EnSight5 Reader**

## EnSight Case Reader

In order to use this reader, you must be familiar with the basic data reader and part loader dialogs discussed previously (see [Chapter 2.1, Reader Basics](#)).

EnSight6 and EnSight Gold are input using the exact same process. The data consists of the following files:

- Case file (required)
- Geometry file (required)
- Variable files (optional)
- Measured/Particle files (optional)
  - Measured/Particle geometry files
  - Measured/Particle variable files

The Case file is a small ASCII file which points to all other files which pertain to the model. The Case file names the geometry and variable files and records time information. The geometry file is a general finite-element format describing nodes and Parts, each Part being a collection of elements, and/or structured ijk blocks. The variable file contains scalar (one value), vector (three values) or tensor (six or 9 values) data at each node and/or element. Measured/Particle files contain data about discrete Particles in space from the simulation code or information directly from experimental data.

EnSight data is based on Parts. The Parts defined in the data are always available on the Server. However, all Parts do not have to be loaded to the Client for display. Large flow fields for CFD problems, for example, are needed for computation by the Server, but can be loaded non-visual.

EnSight data can be transient. The geometry as well as the variables can change with each timestep. The casefile contains the filenames or filename patterns for the transient data.

### *Overview Typical Two-Step Load*

Typically the user will navigate the directory structure in the Directory Field, or type the directory in the Filter field to locate the case file (typically named with a suffix .case), select the case file, click on the (Set) Case button and then click on the Okay button, thus loading using all the defaults. Then the user will simply click Load All in the Data Part Loader to load all parts. For basic details see [Two Step Load Data Reader](#)

### *Overview Typical Quick Load*

Even quicker for Case file format, from the menu, Main Menu > File > Open . . . then user can select the file and Okay (or just double-click on the file), and all the parts are loaded using all the default selections, with no intermediate part loader step. For basic details see [Quick Load](#)

### *Format*

Specifies the Format of the dataset. To read EnSight6 or EnSight Gold data, use the Case format.

### *(Set) Case*

Clicking this button inserts the Case file name shown in the Files Selection field and inserts the path information into the Path field. The Case File name can alternatively be typed into the field.

### *(Set) Result*

This field is not used as the Case file has all the result filenames.

### *(Set) Measured*

This file is not used as the Case file has the measured filename.  
(see [How To Read Data](#))

## EnSight5 Reader

EnSight5 input data consists of the following files:

- Geometry file (required)
- Result file (optional)
- Variable files (optional)
- [Measured Particle Files](#) (optional)
  - Measured/Particle geometry files
  - Measured/Particle results files
  - Measured/Particle variable files

The geometry file is a general finite-element format describing nodes and Parts, each Part being a collection of elements. The result file is a small ASCII file allowing the user to name variables and provide time information. The result file points to variable files which contain the scalar or vector information for each node. Measured/Particle files contain data about discrete Particles in space from the simulation code or information directly from actual experimental tests.

EnSight5 data is based on Parts. The Parts defined in the data are always available on the Server. However, all Parts do not have to be loaded to the Client for display. Large flow fields for CFD problems, for example, are needed for computation by the Server, but do not generally need to be seen graphically.

EnSight5 data can have changing geometry, in which case the changing geometry file names pattern is contained in the results file. However, it is still necessary to specify an initial geometry file name in the (Set) Geometry field.

### *Overview Typical Two-Step Load*

Typically the user will navigate the directory structure in the Directory Field, or type the directory in the Filter field to locate the geometry file (typically named with a suffix `.geo`), select the file, click on the (Set) Geometry button and then select the results file (typically named with a suffix `.res`), click on the (Set) result button and then click on the Okay button, thus loading using all the defaults. Then the user will simply click Load All in the Data Part Loader to load all parts. For basic details see [Two Step Load Data Reader](#).

### *Overview Typical Quick Load*

Even quicker for EnSight 5 file format, from the menu, Main Menu > File > Open... the user can select the `.geo` file and Okay, and all the parts are loaded using all the default selections (using the matching results file, `.res`), with no intermediate part loader step. For basic details see [Quick Load](#).

### *Format*

Specifies the Format of the dataset. To read EnSight5 data, use the **EnSight 5** format.

### *(Set) Geometry*

Clicking this button inserts the `.geo` file name shown in the Files Selection field and inserts the path information into the Path field. The Geometry File name can alternatively be typed into the field.

### *(Set) Result*

Clicking this button inserts the `.res` Results Filename shown in the Files Selection field and inserts the path information into the Path field. The Results Filename can alternatively be typed into the field.

### *(Set) Measured*

Clicking this button inserts the measured filename shown in the Files Selection field and inserts the path information into the Path field. The Measured Filename can alternatively be typed into the field.

### *(Set) Boundary*

This is not used because this format does not support structured data.  
(see [How To Read Data](#))

## 2.3 Other Readers

**ABAQUS\_FIL Reader**  
**ABAQUS\_ODB Reader**  
**Medina BIF-BOF PERMAS Reader**  
**ANSYS Reader**  
**AVUS Reader**  
**CFF Reader**  
**CFX4 Reader**  
**CGNS Reader**  
**ESTET Reader**  
**EXODUS II Gold Reader**  
**FAST UNSTRUCTURED Reader**  
**FIDAP NEUTRAL Reader**  
**FLUENT Direct Reader**  
**FLUENT UNIVERSAL Reader**  
**HDF Reader**  
**LS-DYNA Reader**  
**Movie.BYU Reader**  
**MPGS 4.1 Reader**  
**MSC.DYTRAN Reader**  
**MSC.NASTRAN Reader**  
**N3S Reader**  
**NetCDF Reader**  
**PLOT3D Reader**  
**RADIOSS Reader**  
**SCRYU Reader**  
**SILO Reader**  
**STL Reader**  
**Tecplot Reader**  
**Vectis Reader**

EnSight includes a number of readers for non-native (non-EnSight) formats. This section includes a description of each of these included readers and includes instruction for their use. Some of the included readers are custom, internal readers, and some of them are written using the standard, User Defined Reader interface.

## 2.3 Other Readers

### User Defined Reader Description

A user defined reader capability is included in EnSight which allows otherwise unsupported structured or unstructured data to be read. In other words, the user can create their own data readers. Each user defined reader utilizes a dynamic shared library produced by the user. Once produced, these readers show up in the list of data formats in the Data Reader Dialog just like the included readers.

### User Defined Reader Implementation

The readers are produced by creating the routines documented in the user-defined API. Two versions of the user defined API are available. The 1.0 API (which has been available since EnSight version 6) was designed to be friendly to those producing it, but requires more manipulation internally by EnSight and accordingly requires more memory and processing time. The 2.0 API (starting with EnSight 7.2) was designed with efficiency in mind. It requires that all data be provided on a part basis, and as such lends itself closely to the EnSight Gold type format. A few of the advantages of the new 2.0 API are:

- Considerably more memory efficient
- Considerably faster
- Tensor variables are supported
- Complex variables are supported
- Geometry and variables can be provided on different time lines
- If boundary representation is available, provides for its use instead of having EnSight compute it.
- Extra GUI capability.

### *Creating Your Own Custom User Defined Reader*

The process for creating and using a user-defined reader is explained in detail in the README files on the installation CD or in your installation directory.

On the CD: /CDROM/ensight80/src/readers

In installation

directory: \$CEI\_HOME/ensight80/src/readers

Therein you will also find a detailed description of each routine in the API and the order in which the routines are called by EnSight. In the subdirectories at the same location as the README's, you will find source code for some sample readers and a README file for working readers. The sample are often helpful examples when producing your own reader.

Start EnSight (or EnSight server) with the command line option (-readerdbg), for a step-by-step echo of reader loading progress.

```
ensight -readerdbg
```

The actual working user defined readers included in the EnSight distribution may vary by hardware platform.



## ABAQUS\_FIL Reader

The ABAQUS .fil reader is available to EnSight users, but the preferred method of loading ABAQUS data is to use the .odb reader (see [Section , ABAQUS\\_ODB Reader](#)).

ABAQUS\_FIL input data consists of the one file with a .fil extension:

- Geometry/Results file (required). This file (the ABAQUS .fil file) contains both the geometry and any requested results. It can be either ASCII or binary.
- [EnSight5 Measured/Particle Files](#) (optional). The measured .res file references the measured geometry and variable files.

EnSight will read ASCII or binary .fil files directly. The element sets in the .fil file will be used for creating parts.

### Overview Typical Two Step Load

Main Menu > File > Data (reader)... For basic details see the Data Reader portion of the [Two Step Load Data Reader](#) introduction, putting the geometry file (typically named with suffix .fil) into the (Set) Geometry field and then see the Part Loader discussion below.

### Data Part Loader

The Part Loader for this reader is simply an informational message with Okay and Cancel buttons, as shown below. There is no way to load part by part in this reader.

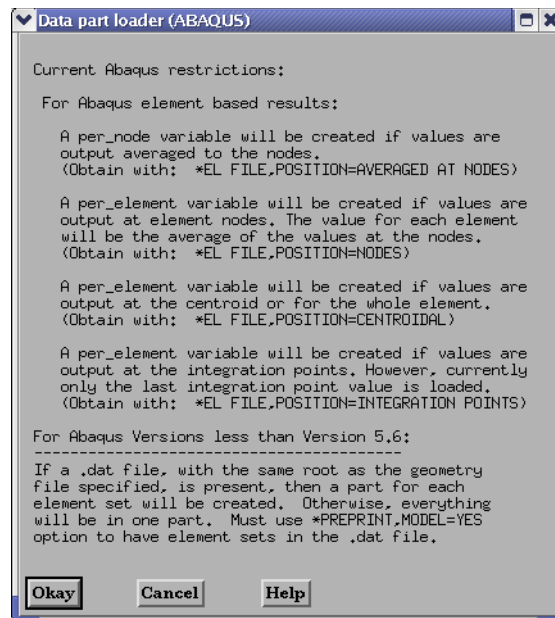

Figure 2-6  
ABAQUS FIL Reader Part Loader dialog

### Format

Choose the **ABAQUS** format.

### (Set) Geometry

Clicking this button inserts the .fil file name shown in the Files Selection field and inserts the path information into the Path field. The Geometry File name can alternatively be typed into field.

### (Set) Measured

Optional measured data field (see [Section , Two Step Load Data Reader](#)). (see [How To Read Data](#))

## ABAQUS\_ODB Reader

### Overview

The ABAQUS odb reader is not included with the EnSight 8 distribution, but is available from the website ([www.ensight.com](http://www.ensight.com)) and click on Support then click on Downloads. This will install the reader and the HKS ODB libraries. Because the reader is dependent upon the ABAQUS libraries, the reader is only available for platforms supported by ABAQUS. See their website for more details.

For updated information please see the file in the following directory:

```
$CEI_HOME/ensight80/src/readers/abaqus/README
```

The ABAQUS odb reader is the recommended method of importing ABAQUS data into EnSight.

#### *Overview Typical Two-Step Load*

Main Menu > File > Data (reader)... For basic details see the Data Reader portion of the [Two Step Load Data Reader](#) introduction, putting the geometry file (typically named with suffix .odb) into the (Set) Geometry field.

#### *Overview Typical Quick Load*

Main Menu > File > Open... then user can select the desired file and Okay, and automatically load all the parts with all the default selections. For basic details see [Quick Load](#).

#### *Format*

To read ABAQUS odb files, choose **ABAQUS\_ODB**. To read ABAQUS .fil files see the previous section.

#### *(Set) Geometry*

Model geometry file name, typically with .odb suffix. Clicking button inserts file name shown in Selection field and inserts path information into Path field. File name can alternatively be typed into field.

#### *(Set) Params*

Field for manually typing parameters that influence the behavior of the reader. This field is optional.

-section first	Use data from first section
-section last	Use data from last section
-ip min	Use data minimum integration points
-ip max	Use data maximum integration point
-ip avg	Use data average integration point
-step 2	Use ABAQUS STEP 2
-all	Read datasets with ALL in their name
-freq	Choose the STEP with modal data
-node	Load nodeset parts
-nonode	Do not load nodeset parts
-surface	Load surface set parts
-nosurface	Do not load surfaceset parts

#### *(Set) Measured*

Optional measured data field (see [Section , Two Step Load Data Reader](#)). (see [How To Read Data](#))

## Medina BIF-BOF PERMAS Reader

### Overview

Currently this reader is supported only for the following architectures: UNIX 64-bit, Linux 32-bit, LINUX IA, HPUX 64-bit, IBM 5.1 64-bit, Win32, SGI 64-bit, and Sun 64-bit.

This reader reads in an ASCII configuration file with a .konfig suffix, which lists the geometry and results filenames.

To use this reader, you need to set the HDMcat environment variable to point to the dscat.ds file as described in the README.

`$CEI_HOME/ensight80/src/readers/medina_bifbof/README`

#### *Overview Typical Two-Step Load*

Main Menu > File > Data (reader)... For basic details see the Data Reader portion of the [Two Step Load Data Reader](#) introduction, putting the configuration file (typically named with suffix .konfig) into the (Set) Geometry field.

#### *Format*

Choose the **Medina bif/bof** format.

#### *(Set) Geometry*

Clicking this button inserts the .konfig file name shown in the Files Selection field and inserts the path information into the Path field. The Geometry File name can alternatively be typed into field.

#### *(Set) Result*

This is not used

#### *(Set) Measured*

Optional measured data field (see [Section , Two Step Load Data Reader](#)). (see [How To Read Data](#))

## ANSYS Reader

### Overview

#### *Two Ansys Readers*

There are two ANSYS readers available in EnSight a legacy reader named ANSYS RESULTS, and the new User Defined Reader named Ansys Results (v8). The newer reader should read the latest Ansys results as well as older versions. The older, legacy reader may be able to read much older, legacy Ansys files.

#### *Legacy Reader Visibility Flag*

The older reader, by default, is not loaded into the list of available readers, and is not discussed in the remainder of this document. In the unlikely event you need to enable this reader, go into the Menu, Edit > Preferences and click on Data and toggle on the reader visibility flag.

#### *Ansys(v8) capabilities and limitations*

Only variables in the .rst file are loaded.

For result files of Ansys version earlier than 5.4 only the stress or strain tensors are stored, not S1,S2,S3,SINT and SEQV. In later ANSYS versions, the strain results may be incomplete. Missing results are not computed automatically. If required they can be computed using EnSight's variable calculator, using the methods TensorEigenvalue, TensorTresca and TensorVonMises.

There is no large file support (filesize > 2GB).

Currently elemental coordinate systems are not supported. Therefore tensor glyphs for elements usually using elemental coordinate systems (like shells, planes) may be drawn in the wrong orientation. This has no influence on S1, S2, S3,SINT, SEQV.

For shells only the top surface results are read.

Tensors are declared as tensors. If only tensor components are required, they have to be computed or extracted using EnSight's variable calculator using the TensorComponent function

The eigenvalues S1,S2,S3 currently are grouped as vector "Principal Stress" etc. In this case the vector components do not have the expected physical meaning. Missing values in the result file are filled with zero.

#### *EnSight Parts*

All the data are imported as one part. The reader uses the user-defined material API. So the separation of the part into different materials can be done using EnSight's material option.

#### *Invalid Data*

Invalid Data are marked as  $2^{100}$  in the result files and converted to zero from the reader.

See the following file for current information on this reader.

`$CEI_HOME/ensight80/src/readers/ansys/README`

#### *Overview Typical Two-Step Load*

Main Menu > File > Data (reader)... For basic details see the Data Reader portion of the [Two Step Load Data Reader](#) introduction, putting the geometry file (typically named with suffix .rst) into the (Set) Geometry field.

#### *Format*

Choose the **Ansys(v8)** format.

#### *(Set) Geometry*

Clicking this button inserts the .rst file name shown in the Files Selection field and inserts the path information into the Path field. The Geometry File name can alternatively be typed into field.

#### *(Set) Measured*

Optional measured data field (see [Section , Two Step Load Data Reader](#)). (see [How To Read Data](#))

## AVUS Reader

### Overview

The AVUS reader has been recently renamed, and was formerly called the COBALT reader.

CEI provides the AVUS user-defined-reader on an "as-is" basis, and does not warrant nor support its use.

There are two distinct readers for AVUS data (formerly Cobalt60) -- one for static data, AVUS (formerly Cobalt60), and one for transient solution data, AVUS Case (formerly Cobalt60 Case).

Both readers will read formatted and unformatted (single or double precision) Cobalt60 grids, solution files (pix files), and Cobalt60 restart files. The file format is determined automatically by the reader. The readers also support an enhanced solution (pix) format that contains additional solution data beyond the normal six fields.

See the following README file for current information on this reader and contact the author as listed in the README file for further information.

```
$CEI_HOME/ensight80/src/readers/avus_cobalt_2/README
```

#### *Overview Typical Two-Step Load Static Data*

Main Menu > File > Data (reader)... For basic details see the Data Reader portion of the [Two Step Load Data Reader](#) introduction, selecting AVUS format, putting the grid file (typically named with suffix .grd) into the (Set) Geometry field and the restart file into the (Set) Results field.

#### *Overview Typical Two-Step Load Transient Data*

Main Menu > File > Data (reader)... For basic details see the Data Reader portion of the [Two Step Load Data Reader](#) introduction, selecting AVUS Case format, putting the ASCII Case file (typically named with suffix .case) into the (Set) Geometry field.

#### *Format*

To read AVUS static data, use the **AVUS** format, to read in AVUS transient data, create an ASCII case file and use the **AVUS Case** format.

#### *(Set) Geometry*

Clicking this button inserts the .case file name (for transient) or the grid file (for static) shown in the Files Selection field and inserts the path information into the Path field. This File name can alternatively be typed into field.

#### *(Set) Result*

Clicking on this button inserts the restart file shown in the Files Selection field and inserts the path information into the Path field (for static data). This field is not used for transient data, as the filenames are all in the ASCII Case file.

#### *(Set) Measured*

Optional measured data field (see [Section , Two Step Load Data Reader](#)). (see [How To Read Data](#))

## 2.3 CFF Reader

### CFF Reader

#### Overview

The CFF Reader is supplied compiled on the SGI, Sun and Linux platforms on an "as-is" basis, and CEI does not warrant nor support its use. A README file as well as the source code is also supplied with the EnSight distribution in the directory below.

```
$CEI_HOME/ensight80/src/readers/cff
```

## CFX4 Reader

### Overview

Reads a 3D Static Cbinary dump (.dmp) file.

See the following file for current information on this reader.

`$CEI_HOME/ensight80/src/readers/cfx4/README`

#### *Overview Typical Two-Step Load*

Main Menu > File > Data (reader)... For basic details see the Data Reader portion of the [Two Step Load Data Reader](#) introduction, putting the dump file (typically named with suffix .dmp) into the (Set) Geometry field.

#### *Format*

Choose the **CFX-4** format.

#### *(Set) Geometry*

Clicking this button inserts the .dmp file name shown in the Files Selection field and inserts the path information into the Path field. The Dump File name can alternatively be typed into field.

#### *(Set) Measured*

Optional measured data field (see [Section , Two Step Load Data Reader](#)).  
(see [How To Read Data](#))

## CGNS Reader

### Overview

See the following file for current information on this reader.

`$CEI_HOME/ensight80/src/readers/cgns/README`

*Overview Typical  
Two-Step Load*

Main Menu > File > Data (reader)... For basic details see the Data Reader portion of the [Two Step Load Data Reader](#) introduction, putting the CGNS file (typically named with suffix .cgns) into the (Set) Geometry field.

*Format*

Choose the **CGNS** format.

*(Set) Geometry*

Clicking this button inserts the .cgns file name shown in the Files Selection field and inserts the path information into the Path field. The Dump File name can alternatively be typed into field.

*(Set) Measured*

Optional measured data field (see [Section , Two Step Load Data Reader](#)).  
(see [How To Read Data](#))



## ESTET Reader

### Reader Visibility Flag

By default, this reader is not loaded into the list of available readers. To enable this reader go into the Menu, Edit > Preferences and click on Data and toggle on the reader visibility flag.

### Overview

ESTET input data consists of one file that contains all geometry and results information. Data is loaded in a multi-step process. The first step, Data Reader is the same as all the other readers. For basic details, read the section on the Data Reader found in [Two Step Load Data Reader](#), then come back here and resume reading.

The ESTET data is a structured grid. The data file is binary.

When reading this data into EnSight, the part loader dialog will be essentially the same as that found in the reader basics for structured data (See [Reading and Loading Data Basics](#)). The data can be in rectangular, cylindrical, or curvilinear coordinates. EnSight will interpret and convert properly for any of these types.

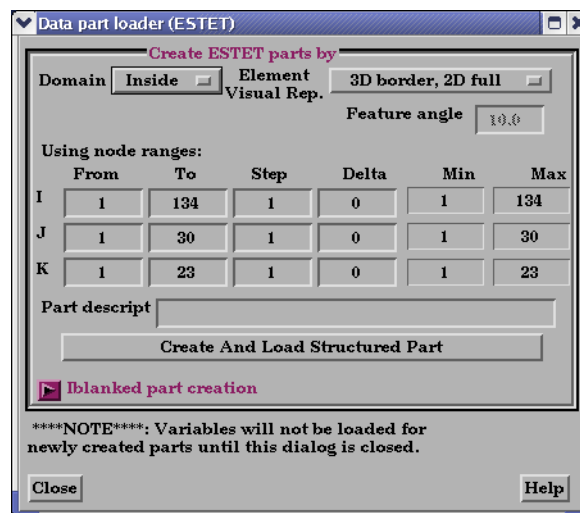

Figure 2-7

ESTET Vector Builder and Data Part Loader dialogs

One difference from the Reader Basics, is that once the desired geometry has been extracted as Parts, you are presented with a list of the results variables contained in the file. There is no way to automatically determine which of the results variables are actually vector components, so you are given the opportunity to build the vectors from the variables. The descriptions usually make this a straightforward process. All variables not used as components to vectors are assumed to be scalar variables.

*ESTET Vector Builder and Data Part Loader dialogs*

Figure 2-8  
ESTET Vector Builder and Data Part Loader dialogs

You use the File Selection dialog to read ESTET data files, the ESTET Vector Builder dialog to build vector variables from scalar components for an ESTET dataset, and the Data Part Loader dialog to extract Parts from an ESTET dataset. The latter two dialogs open in sequence automatically after you click Okay in the File Selection dialog.

Access: Main Menu > File > Data (Reader)...> ESTET

(see [How To Read Data](#))

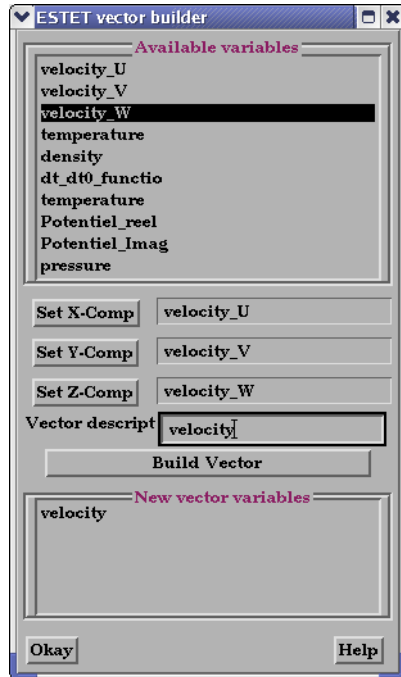
## EXODUS II Gold Reader

### Overview

#### *Misc Notes*

The Exodus reader links to the exodus routines in libexoIIc.a and the netcdf routines in libnetcdf.a. You must have these libraries to compile and run the ExodusII reader.

Variable names that end in "\_x", "\_y", "\_z" will be treated as components of a vector. For example, the variables "vel\_x", "vel\_y", "vel\_z" will be treated as a vector named "vel\_vec". Case is ignored in matching variable names.

#### *GUI control of Reader*

Note reader behavior can also be controlled in the Data Reader GUI via checkboxes and fields. The environment variables (if set) are used to set the default values for the GUI.

#### *Advanced Multiple File Naming*

This reader supports two extensions to the filename fields. The first supports Exodus datasets where the geometry changes at some point in time. In this case, a new Exodus file (or set of files) is used for each set of solution times. To support this feature, insert wildcard characters (e.g. "\*" and "?") in the filename that expand to the name of the first files in each timeset.

The second extension allows for multiple files to be read as part of the same timeset (e.g. domain decomposed files). This feature takes the form of a tag (<X:Y>) appended to the filename. The value of "X" is the number of files in the timeset and "Y" is the sprintf() format string for expanding an integer argument into a string. For example, if a dataset consists of the following files:

```
Times_0-10          Times_11-15
foo.1_03.00        foo.2_03.00
foo.1_03.01        foo.2_03.01
foo.1_03.02        foo.2_03.02
```

Where the "foo.1\*" files contain timesteps 0 through 10 and the "foo.2\*" files contain timesteps 11 through 15. Also, each timeset is decomposed into 3 subfiles, which each contain some portion of the dataset for the given timesteps. In this example, one would use the filename "foo.?\_03.<3:%0.2d>" to tell EnSight there are multiple timesets and to generate the filenames for each timeset by replacing the "<.>" substring with a number from 0 to 2 as generated using sprintf() and "%0.2d". Note that the "<...>" marker must be the last part of the filename.

When using SoS casefiles, the servers will automatically distribute the subfiles over all of the specified servers. There can be no more servers than the number of sub-files however (but fewer are legal). Finally, if there are sub-files, the number and the naming convention must be the same over all timesets.

#### *Names file format*

The .names file can be used to name parts in a Exodus file. Note that the names for these files are generated by clipping off the input Exodus filename at the rightmost '.' and adding the suffix ".materials" or ".names". External part names and materials files have the same syntax.

```
*   File containing block, sideset, nodeset names
*   -----
*   (Must have the same root as the .exo file, and reside in the same
*   directory, and have a .names extension)
*
*   Note: 1. Comments have a # in first column of the line.
```

```

*
*           2. Three types of sections (must be exactly as indicated):
*
*           blocks
*           sidesets
*           nodesets
*
*           (Presence of any of the sections is optional - for example,
*           if you only have blocks, you don't need the sidesets or
*           nodesets sections.)
*
*           3. There must be a number, white space, then name
*           on lines within the sections.
*
*           numbers must be 1-based (relates to the block number)
*
*           names must be a single token - no spaces (Underscores or
*           dashes are okay.)
*
*           4. Line length must be less than 80 chars - which should be
*           plenty since EnSight truncates names at 49 chars.
*
* Thus, general format is:
*
* blocks
* 1      name_for_block_1
* 2      name_for_block_2
* .
* .
* .
* n      name_for_block_n
* sidesets
* 1      name_for_sideset_1
* 2      name_for_sideset_2
* .
* .
* .
* m      name_for_sideset_m
* nodesets
* 1      name_for_nodeset_1
* 2      name_for_nodeset_2
* .
* .
* .
* p      name_for_nodeset_p
*
*
* Here is an Example:
* -----
* blocks
* 1          Strongback
* 2          bolt_1
* 3          bolt_2
* 4          bolt_3
* 5          nut_1
* 6          nut_2
* 7          nut_3
* 8          Tab
* 9          screw_1
* 10         screw_2
* 11         screw_3
* 12         Block
* sidesets
* 1          Strongback_end
* 2          Strongback_front
* 3          Strongback_back
* nodesets

```

\* 1 Tab\_nodes

For the previous example, the files would be named "foo.1\_03.names" and "foo.1\_03.materials". Only one .names and one .materials file is required.

See the following file for current information on this reader.

```
$CEI_HOME/ensight80/src/readers/exodus_gold
```

## Data Reader

*Overview Typical  
Two-Step Load*

Main Menu > File > Data (reader)... For basic details see the Data Reader portion of the [Two Step Load Data Reader](#) introduction, putting the geometry file (typically named with suffix .ex, or .ex2, or .exo) into the (Set) Geometry field.

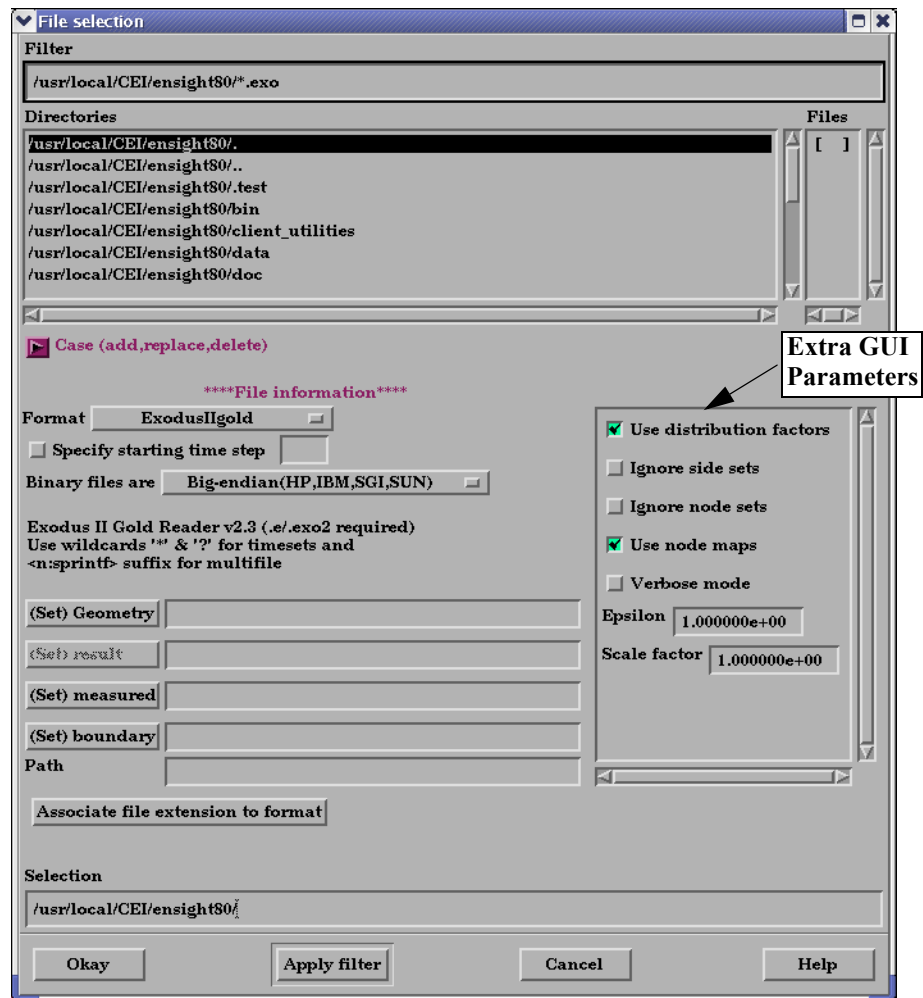

Figure 2-9  
Exodus Data Reader dialog

*Overview Typical  
Quick Load*

Main Menu > File > Open... then user can select the desired file and Okay, and automatically load all the parts with all the default selections. For basic details see [Quick Load](#).

*Format*

Choose **ExodusIIgold**.

<i>(Set) Geometry</i>	<p>This field should have the .exo, .ex or .ex2 file name. Clicking button inserts file name shown in Selection field and inserts path information into Path field. File name can alternatively be typed into field. Enter the name of the data file in the geometry field.</p> <p>If there are multiple Exodus files in the solution set, you may enter a filename with wildcard characters, for example, "mydata*.exo2" or "mydata1?.exo2"</p>
<i>(Set) Measured</i>	Optional measured data field (see <a href="#">Section , Two Step Load Data Reader</a> ).
<b>Extra GUI Parameters</b>	These toggles and fields below are customized for the Exodus reader.
<i>Use Distribution Factors</i>	<p>If nonzero, use support distribution factors (off by default). Node sets and side sets in Exodus can have distribution factor weights associated with them. If this option is set, these distribution factors will be read by EnSight as additional scalar variables on the node or side set parts. If the Environment Variable ENSIGHT_EXODUS_DF (or EXODUS_DF) is set, then the reader will use it to set the default value.</p>
<i>Ignore Side Sets</i>	<p>If nonzero, disable sideset support (enabled by default). If the Environment Variable ENSIGHT_EXODUS_NO_SIDESETS is set then the reader will use it to set the default value.</p>
<i>Ignore Node Sets</i>	<p>If nonzero, disable nodeset support (enabled by default). If the Environment Variable ENSIGHT_EXODUS_NO_NODESETS is set then the reader will use it to set the default value.</p>
<i>Use Node Maps</i>	<p>If nonzero, use node maps (default true). Exodus files may contain element and nodal labels, referred to as nodemaps. If this option is set, EnSight will use the labels in the Exodus files. There is no guarantee (particularly when using spatially decomposed Exodus files) that these numbers are unique over all the nodes and elements. If this option is not set, EnSight will ignore the labels in the Exodus file and use an internal numbering scheme guaranteed to generate unique node and element labels.</p> <p>If the Environment Variable ENSIGHT_EXODUS_USE_NODEMAPS is set then the reader will use it to set the default value.</p>
<i>Verbose Mode</i>	<p>If nonzero, enable verbose mode (off by default). See the console for the verbose output. If the Environment Variable ENSIGHT_EXODUS_VERBOSE is set then the reader will use it to set the default value.</p>
<i>Epsilon</i>	<p>Set to a temporal epsilon (default 1.0). This number is used to adjust non-monotonically increasing solution times. If the reader detects consecutive solution times (as floats) that do not progress forward in time, the later solution time value will be set to the earlier time plus this value. Note: this can have a cascading effect shifting other solution times later as well. This feature is generally useful when the solution times in the Exodus II file are all the same value. If the Environment Variable ENSIGHT_EPSILON is set, then the reader will use it to set the default value.</p>
<i>Scale Factor</i>	<p>Set to a scaling factor (default 1.0). This number is multiplied by each of the x, y, and z geometry coordinates in order to scale the geometry. If the Environment Variable ENSIGHT_EXODUS_SCALE is set, then the reader will use it to set the default value.</p> <p>(see <a href="#">How To Read Data</a>)</p>

## FAST UNSTRUCTURED Reader

### Overview

FAST UNSTRUCTURED is a format containing triangle and/or tetrahedron elements. The triangles have tags indicating a grouping for specific purposes. EnSight will read the unstructured single zone grid format for this data type, placing all tetrahedral elements into the first Part, and the various triangle element groupings into their own Parts.

#### Overview Typical Two-Step Load

Main Menu > File > Data (reader)... For basic details see the Data Reader portion of the [Two Step Load Data Reader](#) introduction, putting the grid file into the (Set) Geometry field and the results file into the (Set) Results field.

Typically the user will navigate the directory structure in the Directory Field, or type the directory in the Filter field to locate the Grid file, select the file, click on the (Set) Geometry button then locate the Results file, click on the (Set) Results button and then click on the Okay button, thus loading using all the defaults. Then the user will simply click Load All in the Data Part Loader to load all parts. For basic details see [Two Step Load Data Reader](#).

#### Format

Choose the **FAST UNSTRUCTURED** format.

#### (Set) Geometry

Clicking this button inserts the grid file name shown in the Files Selection field and inserts the path information into the Path field. This is the FAST UNSTRUCTURED single zone grid file. Defines the geometry as unstructured triangles and/or tetrahedrons. The Grid File name can alternatively be typed into field.

#### (Set) Result

Clicking this button inserts the optional results file name shown in the Files Selection field and inserts the path information into the Path field. The Results file can either be a Modified Result file which utilizes a modified EnSight results file format, or can be variable files (optional) which are either a PLOT3D solution file (Q-file) or FAST function file with I = number of points and J=K=1. The modified EnSight results file provides access to multiple solution files that are produced by time dependent simulations.

FAST UNSTRUCTURED data can have changing geometry. When this is the case, the changing geometry file names are contained in the results file. However, it is still necessary to specify an initial geometry file name.

WARNING: Do not use your solution file (e.g. file.q) here. You must create a special results file to handle FAST variable files.

#### (Set) Measured

Optional measured data field ([see Section , Two Step Load Data Reader](#)).

#### Part Loader

The FIDAP reader uses a simplified Part Loader as follows:



- All Parts: all parts are loaded to the client in the default visual representation (typically 3D Border, 2D Full).
- Part 1 Only: Only the first part is loaded to the client in the default visual representation. The other parts will have the NonVisual representation.
- All But Part 1: All parts other than part 1 are loaded to the client in the default visual representation. Part 1 will be NonVisual.
- No Parts: No parts are loaded to the client (i.e. the representation of all parts is set to NonVisual).

(see [How To Read Data](#))

## FIDAP NEUTRAL Reader

### Overview

A FIDAP Neutral file contains all of the necessary geometry and result information for use with EnSight.

A neutral file is produced by a separate procedure defined in the FIDAP documentation. If the data is time dependent this information is also defined here.

#### *Overview Typical Two-Step Load*

Main Menu > File > Data (reader)... For basic details see the Data Reader portion of the [Two Step Load Data Reader](#) introduction, putting the geometry file into the (Set) Geometry field. Then the user will click All parts, Part 1 only, All but part 1, or No parts in the Data Part Loader to load the part in their desired visual representation. For basic details see Data Reader Section in [Two Step Load Data Reader](#) and then come back here for a discussion of the Part Loader.

#### *Format*

Choose the **FIDAP NEUTRAL** format.

#### *(Set) Geometry*

Clicking this button inserts the grid file name shown in the Files Selection field and inserts the path information into the Path field. This is the FIDAP Neutral file. The Neutral File name can alternatively be typed into field.

#### *(Set) Measured*

Optional measured data field (see [Section , Two Step Load Data Reader](#)). (see [How To Read Data](#))

#### *Part Loader*

The FIDAP reader uses a simplified Part Loader as follows:



- All Parts: all parts are loaded to the client in the default visual representation (typically 3D Border, 2D Full).
- Part 1 Only: Only the first part is loaded to the client in the default visual representation. The other parts will have the NonVisual representation.
- All But Part 1: All parts other than part 1 are loaded to the client in the default visual representation. Part 1 will be NonVisual.
- No Parts: No parts are loaded to the client (i.e.the representation of all parts is set to NonVisual).

(see [How To Read Data](#))



## FLUENT Direct Reader

### Overview

There are three methods to get Fluent data into EnSight. The first is to use this direct reader (D\_Fluent reader) for Fluent data. This reader reads a Fluent Case (.cas) file and data (.dat) file. The second method to get data into EnSight is to use Fluent's EnSight Case Gold Export option and read it directly into EnSight using the Case reader. The last method is really a legacy reader for Fluent Universal file and is described later under the FLUENT UNIVERSAL Reader.

See the following file for current information on this reader.

`$CEI_HOME/ensight80/src/readers/fluent/README`

#### *Overview Typical Two-Step Load*

Main Menu > File > Data (reader)... For basic details see the Data Reader portion of the [Two Step Load Data Reader](#) introduction, putting the case file (typically named with suffix .cas) into the (Set) Geometry field and the Fluent data file (typically named with a suffix .dat).

#### *Format*

Choose the **D\_Fluent** (direct Fluent) format.

#### *(Set) Geometry*

Clicking this button inserts the .cas file name shown in the Files Selection field and inserts the path information into the Path field. The Case File name can alternatively be typed into field.

#### *(Set) Result*

Clicking this button inserts the .dat file name shown in the Files Selection field and inserts the path information into the Path field. The Data File name can alternatively be typed into field.

#### *(Set) Measured*

Optional measured data field (see [Section , Two Step Load Data Reader](#)). (see [How To Read Data](#))

## FLUENT UNIVERSAL Reader

#### *Reader Visibility Flag*

This is not the preferred reader for Fluent data. Therefore, by default, this reader is not loaded into the list of available readers. The preferred reader for Fluent data is the Fluent Direct Reader. If you have Universal file data, you can enable this reader as follows: go into the Menu, Edit > Preferences and click on Data and toggle on the reader visibility flag.

The FLUENT Universal file contains all of the necessary geometry and result information for use with EnSight for a steady-state case. If the case is transient, EnSight needs a Universal file for each time step of the analysis and a modified version of the EnSight results file.

#### *Overview Typical Two-Step Load*

Main Menu > File > Data (reader)... Put the Universal file into the (Set) Geometry field. Click Okay. Then the user will click All parts, Part 1 only, All but part 1, or No parts in the Data Part Loader to load the part in their desired visual representation. For basic details see Data Reader Section in [Two Step Load Data Reader](#) and then come back here for a discussion of the Part Loader.

#### *Format*

Choose the **FLUENT UNIVERSAL** format.

#### *(Set) Geometry*

Clicking this button inserts the universal file name shown in the Files Selection field and inserts the path information into the Path field. This is the Fluent Universal file. The Universal File name can alternatively be typed into field.

#### *(Set) Measured*

Optional measured data field (see [Section , Two Step Load Data Reader](#)). (see [How To Read Data](#))

*Part Loader*

The Fluent Universal reader uses a simplified Part Loader as follows:



- All Parts: all parts are loaded to the client in the default visual representation (typically 3D Border, 2D Full).
- Part 1 Only: Only the first part is loaded to the client in the default visual representation. The other parts will have the NonVisual representation.
- All But Part 1: All parts other than part 1 are loaded to the client in the default visual representation. Part 1 will be NonVisual.
- No Parts: No parts are loaded to the client (i.e.the representation of all parts is set to NonVisual).

(see [How To Read Data](#))

## HDF Reader

### Overview

This is an example implementation by CEI using the HDF5 libraries for file I/O. EnSight includes the source code and header file that can be used as a template for users who wish to design their own data format.

See the following directory for the source files and the Makefile for this reader.

```
$CEI_HOME/ensight80/src/readers/hdf5
```

### Data Reader

Main Menu > File > Data (reader)...

The File Selection dialog is used to specify which files you wish to read.

Access: Main Menu > File > Data (Reader)...

#### *Overview Typical Two-Step Load*

Main Menu > File > Data (reader)... For basic details see the Data Reader portion of the [Two Step Load Data Reader](#) introduction, putting the HDF5 case file into the (Set) Geometry field.

#### *Format*

Choose **Special HDF5**.

#### *(Set) Geometry*

This field should have the ASCII case file name. Clicking button inserts file name shown in Selection field and inserts path information into Path field. File name can alternatively be typed into field.

#### *(Set) Measured*

Optional measured data field (see [Section , Two Step Load Data Reader](#)).

#### *(Set) Boundary*

If data contains structured data, this file can be used (see [How To Read Data](#)).

## LS-DYNA Reader

### Overview

The LS-DYNA reader reads in a single or multiple unstructured C-binary d3plot files. It supports bars, quads, bricks and thick shell elements.

#### *Key File for Part Naming*

Can use of Key file to name parts as follows:

- a. Works only if Material IDs are in the d3plot file
- b. Put key file name into Params field
- c. Looks for \*PART keyword in keyfile
- d. '\$' in first column is a comment in keyfile
- e. First non-comment line after \*PART is used as partname if alpha or digit
- f. Second non-comment line after \*PART, 3rd integer is Material ID
- g. If Mat'l ID in d3plot matches Mat'l ID in keyfile partname from key file is substituted for Material ID in EnSight name.

#### Limitations

The reader has the following limitations.

Doesn't support PACKED data (3 integers per word)

Skips over Smooth Particle Hydrodynamics Node data

Skips over Rigid Road Surface Data.

Skips over Computational Fluid Dynamics Data.

Does not read in LS-DYNA time-history plots

Coordinate System: Global vs. Local: Beam stresses and strains are always output in the local r,s,t system. Per LSTC manual, stresses and strains of the other elements are generally in the global system. However, shells & thick shells have an option to output in local system (see LS-DYNA 960 keyword users manual page 9.18. flag CMPFLG). The reader has no way of knowing whether stresses and strains are output in the global or local system and just shows the values contained in the files.

See the following file for current information on this reader.

`$CEI_HOME/ensight80/src/readers/ls-dyna3d/README`

## Data Reader

*Overview Typical  
Two-Step Load*

Main Menu > File > Data (reader)... For basic details see the Data Reader portion of the [Two Step Load Data Reader](#) introduction, putting the d3plot file (typically named with prefix d3plot\*\*\*) into the (Set) Geometry field.

*Overview Typical  
Quick Load*

Main Menu > File > Open... then user can select the desired file and Okay, and automatically load all the parts with all the default selections. For basic details see [Quick Load](#).

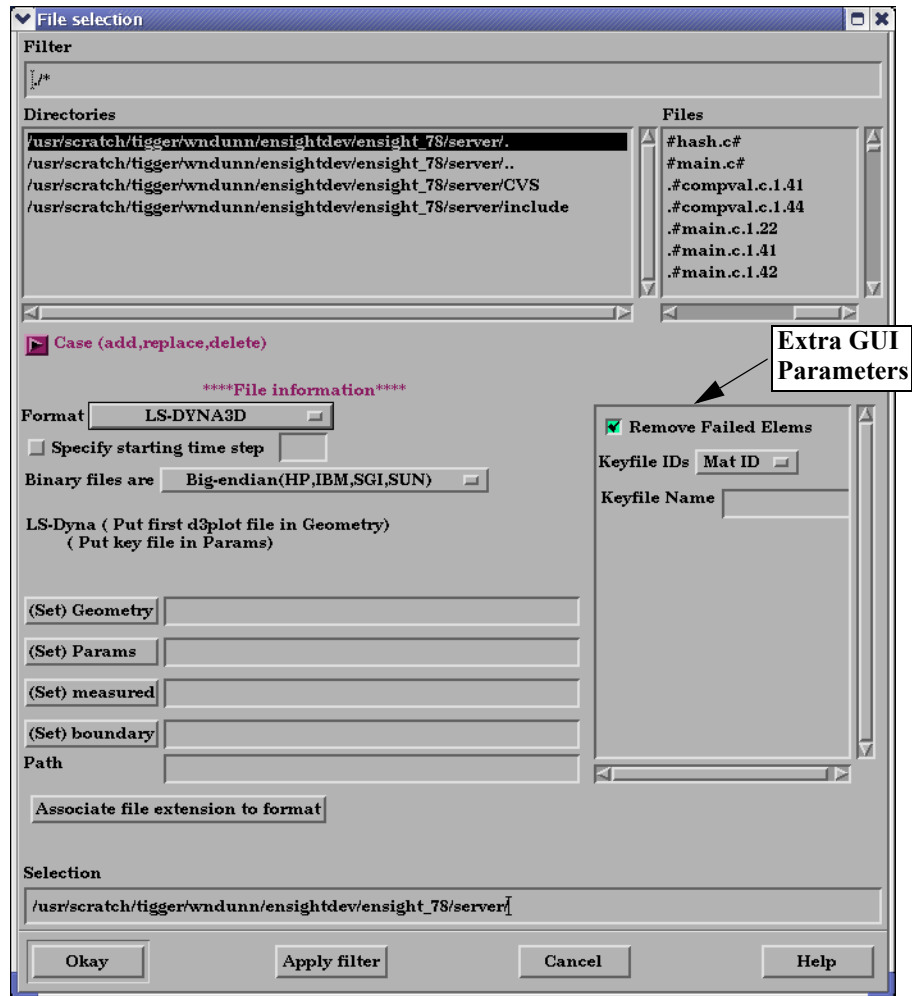

Figure 2-10  
Data Reader dialog

Main Menu > File > Data (reader)...

The File Selection dialog is used to specify which files you wish to read.

Access: Main Menu > File > Data (Reader)...

**Format**

Choose **LS-DYNA3D**.

**(Set) Geometry**

This field should have the first d3plot file name. Clicking button inserts file name shown in Selection field and inserts path information into Path field. File name can alternatively be typed into field. All of the d3plot files will be loaded starting with this first one.

**(Set) Param**

This field can be used to import parameters that modify the behavior of the reader, or the Extra GUI pulldown and field can be used to choose which ids to use for naming and to name the keyfile respectively.

keyfilename - Type the keyfile name into this field

-mid - use material id in keyfile to name parts in d3plot file.

-pid - use part id in keyfile to name parts in d3plot file.

example:

file.key -mid

This will use the material ids in keyfile named file.key to name parts.

*(Set) Measured*

Optional measured data field ([see Section , Two Step Load Data Reader](#)).

**Extra GUI  
Parameters**

These toggles and fields below are customized for the LS-DYNA3D reader.

*Remove Failed  
Elements*

This toggle causes failed elements to be removed.

*Keyfile ID*

This pull-down provides the choice of either Material IDs or Part IDs from the keyfile to be used for part naming. Alternatively, the ID can be specified in the (Set) Params field as described above.

*Keyfile Name*

This field is where the keyfile name (used in automatic part naming) can be entered. The keyfile name can also be entered in the (Set) Params field as described above.

(see [How To Read Data](#))

## Movie.BYU Reader

### *Reader Visibility Flag*

By default, this reader is not loaded into the list of available readers. To enable this reader go into the Menu, Edit > Preferences and click on Data and toggle on the reader visibility flag.

## Overview

Movie.BYU has a general n-sided polygon data format. In translating this format to the element-based EnSight data format, not all elements possible in the Movie.BYU format can be converted to EnSight format. However, for most practical cases there are no problems.

Movie.BYU data can have changing geometry. When this is the case, the changing geometry file name patterns are found in the results file. However, it is still necessary to specify an initial geometry file name in the (Set) Geometry field.

### *Overview Typical Two-Step Load*

Main Menu > File > Data (reader)... Put the Movie file into the (Set) Geometry field. Then the user will click All parts, Part 1 only, All but part 1, or No parts in the Data Part Loader to load the part in their desired visual representation. For basic details see Data Reader Section in [Two Step Load Data Reader](#) and then come back here for a discussion of the Part Loader.

### *Format*

Choose the **Movie** format.

### *(Set) Geometry*

Clicking this button inserts the Geometry file name (typically .geo) shown in the Files Selection field and inserts the path information into the Path field. This defines all geometric model Parts in a general n-sided polygon format. The File name can alternatively be typed into field.

### *(Set) Result*

EnSight Results file (typically .res) which lists the Variable filenames with file for each variable, containing either scalar or vector information for every node defined in the geometry file

### *(Set) Measured*

Optional measured data field ([see Section , Two Step Load Data Reader](#)).

### *Part Loader*

The reader uses a simplified Part Loader as follows:



- All Parts: all parts are loaded to the client in the default visual representation (typically 3D Border, 2D Full).
- Part 1 Only: Only the first part is loaded to the client in the default visual representation. The other parts will have the NonVisual representation.
- All But Part 1: All parts other than part 1 are loaded to the client in the default visual representation. Part 1 will be NonVisual.
- No Parts: No parts are loaded to the client (i.e.the representation of all parts is set to NonVisual).

(see [How To Read Data](#))

## MPGS 4.1 Reader

### *Reader Visibility Flag*

MPGS is considered a legacy format. Therefore, by default, this reader is not loaded into the list of available readers. To enable this reader go into the Menu, Edit > Preferences and click on Data and toggle on the reader visibility flag.

## Overview

MPGS4.x uses a general n-sided polygon, n-faced polyhedral data format. In going from this format to the specific element data format of EnSight, you encounter the problem associated with translating from a general format to a specific format. Not all elements possible in MPGS4.x can be converted to EnSight format. However, there will not be a problem in most situations.

MPGS4.x models of modest size can be read directly into EnSight. Size can become an issue since the amount of memory needed to do the conversion in EnSight to the internal data format in a reasonable length of time can become excessive for large models.

MPGS4.x data can have changing geometry. When this is the case, the changing geometry file name patterns are contained in the results file. However, it is still necessary to specify an initial geometry file name in the (Set) Geometry field.

### *Overview Typical Two-Step Load*

Main Menu > File > Data (reader)... Put the MPGS file into the (Set) Geometry field and the Results file into the (Set) Results field. Then click All parts, Part 1 only, All but part 1, or No parts in the Data Part Loader to load the part in their desired visual representation. For basic details see Data Reader Section in [Two Step Load Data Reader](#) and then come back here for a discussion of the Part Loader.

### *Format*

Choose the **MPGS 4.1** format.

### *(Set) Geometry*

Clicking this button inserts the MPGS Geometry file name shown in the Files Selection field and inserts the path information into the Path field. This is the file. The MPGS Geometry file defines all geometric model Parts in a general n-sided polygon format. The Filename can alternatively be typed into field.

### *(Set) Result*

Clicking on this button inserts the MPGS Results file name shown in the Files Selection field and inserts the path information into the Path field. This is the EnSight results file format.

### *(Set) Measured*

Optional measured data field ([see Section , Two Step Load Data Reader](#)).

### *Part Loader*

The MPGS reader uses a simplified Part Loader as follows:



- All Parts: all parts are loaded to the client in the default visual representation (typically 3D Border, 2D Full).
- Part 1 Only: Only the first part is loaded to the client in the default visual representation. The other parts will have the NonVisual representation.
- All But Part 1: All parts other than part 1 are loaded to the client in the default visual representation. Part 1 will be NonVisual.
- No Parts: No parts are loaded to the client (i.e.the representation of all parts is set to NonVisual).

(see [How To Read Data](#))



## MSC.DYTRAN Reader

### Overview

Reads archive files ".ARC" directly, a modified case file, or a .dat file (which is the preferred method).

See the following file for current information on this reader.

`$CEI_HOME/ensight80/src/readers/dytran/README`

#### *Overview Typical Two-Step Load*

Main Menu > File > Data (reader)... For basic details see the Data Reader portion of the [Two Step Load Data Reader](#) introduction, putting the file (typically named with suffix .dat or .arc) into the (Set) Geometry field.

#### *Overview Typical Quick Load*

Main Menu > File > Open... then user can select the desired file and Okay, and automatically load all the parts with all the default selections. For basic details see [Quick Load](#).

#### *Format*

To read Dytran archive files or .dat files, choose **DYTRAN**.

#### *(Set) Geometry*

This field should have the .dat or .arc suffix. Clicking button inserts file name shown in Selection field and inserts path information into Path field. File name can alternatively be typed into field. Selecting any one file will read only that file. Inserting wild card characters, such as '\*' and '?', will cause all files of a set to be read. For example, if I enter CONTAINER\_EUL\_\*.ARC, the program will match the pattern to all the files below.

#### *(Set) Measured*

Optional measured data field (see [Section , Two Step Load Data Reader](#)). (see [How To Read Data](#))

## MSC.NASTRAN Reader

### Overview

Reads .op2 suffix files including most PDA Patran (PARAM POST = -1) and SDRC I-DEAS (PARAM POST = -2) files.

#### *Limitations*

- a) Binary format only. (If you need to read ASCII, convert using the Nastran utility that will do this.)
- b) Some non-linear and composite element types have not yet been implemented. See the following file for current information on this reader.

`$CEI_HOME/ensight80/src/readers/nastran/README`

#### *Overview Typical Two-Step Load*

Main Menu > File > Data (reader)... For basic details see the Data Reader portion of the [Two Step Load Data Reader](#) introduction, putting the NASTRAN file (typically named with suffix .op2) into the (Set) Geometry field.

#### *Overview Typical Quick Load*

Main Menu > File > Open... then user can select the desired file and Okay, and automatically load all the parts with all the default selections. For basic details see [Quick Load](#).

#### *Format*

Choose **NASTRAN OP2**.

#### *(Set) Geometry*

This field should have the .op2 file name. Clicking button inserts file name shown in Selection field and inserts path information into Path field. File name can alternatively be typed into field.

#### *(Set) Measured*

Optional measured data field (see [Section , Two Step Load Data Reader](#)). (see [How To Read Data](#))

## N3S Reader

### Reader Visibility Flag

By default, this reader is not loaded into the list of available readers. To enable this reader go into the Menu, Edit > Preferences and click on Data and toggle on the reader visibility flag.

## Overview

### Description

N3S is a data format developed by Electricité de France (EDF) consisting of a geometry file and a results file. For this data format, both files are always required. Versions 3.0 and 3.1 are both supported.

When reading N3S data into EnSight, you extract Parts from the mesh interactively based on different color numbers or boundary conditions. The available color numbers and boundary conditions for the model are presented.

### Overview Typical Two-Step Load

Main Menu > File > Data (reader)... For basic details see the Data Reader portion of the [Two Step Load Data Reader](#) introduction, putting the N3S file (typically named with .geo) into the (Set) Geometry field and the Results file (typically with a suffix .res) into the (Set) Results.

### Format

Choose **N3S**.

### (Set) Geometry

Clicking this button inserts the Geometry file name (typically .geo) shown in the Files Selection field and inserts the path information into the Path field. The File name can alternatively be typed into field.

### (Set) Result

Clicking this button inserts the Results file name (typically .res) shown in the Files Selection field and inserts the path information into the Path field. The Results file contains the scalar and vector variable values. The File name can alternatively be typed into field.

### (Set) Measured

Optional measured data field ([see Section , Two Step Load Data Reader](#)).

## N3S Part Creator dialog

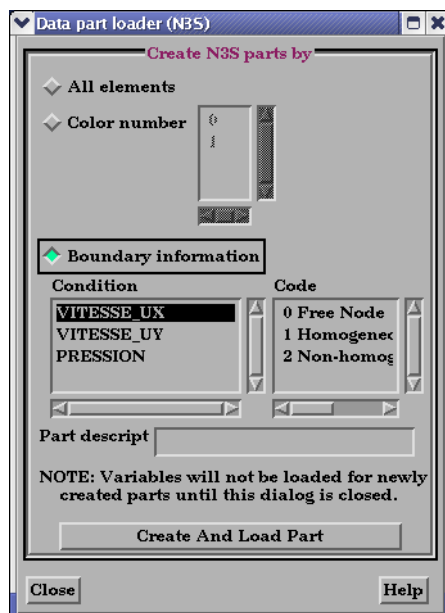

Figure 2-11

N3S Part Creator dialog

You use the File Selection dialog to read in N3S dataset files. You use the N3S Part Creator dialog to extract Parts from a N3S dataset.

Access: Main Menu > File > Data (Reader)... > N3S

## 2.3 N3S Reader

### *Create N3S Parts By*

All Elements	Selection to create a Part using all of the elements available within the data file.
Color Number	Selection to create a Part according to the color number associated with each element.
Boundary Information	Selection to create a Part according to specified conditions and codes.
Condition	Select boundary condition to use for Part creation.
Code	Select Code to use for boundary condition.

*Part Descript* Specify name for Part.

*Create Part* Click to create a Part. The Part is listed in the main Parts list of the Parts & Frames dialog and is displayed in the Main View window.  
(see [How To Read Data](#))

## NetCDF Reader

### Overview

#### *Description*

Data reader for EnSight for Unidata NetCDF files. This is an example of one specific implementation using NetCDF libraries, and is not intended to be a general implementation.

<http://www.unidata.ucar.edu/packages/netcdf>

#### *LIMITATIONS*

1. Only reads four types of data

lonlat: geometry specified in terms of longitude and latitude

llonlat\_w\_elev: geometry specified similar to lonlat, except also allows the use of a scalar variable for surface perturbation.

lonlatlev: geometry specified in terms of longitude, latitude, and levels (altitudes)

xyz: geometry specified in terms of cartesian coordinates

#### *NCASE File*

Requires the use of an NCASE text file that describes how the data in a netCDF file is to be interpreted. The NCASE file is input in the "Case" field when using the

The NCASE file is divided into five sections: FORMAT, DATA, GEOMETRY, VARIABLE, and TIME. These sections must appear in the previously listed order. The section begins with a line that has the name of the section.

#### *README*

See the following file for more details on the ncase file and for current information on this reader.

`$CEI_HOME/ensight80/src/readers/netcdf/README`

#### *Overview Typical Two-Step Load*

Main Menu > File > Data (reader)... For basic details see the Data Reader portion of the [Two Step Load Data Reader](#) introduction, putting the NetCDF NCASE file (typically named with a suffix .ncase) into the (Set) Geometry field.

#### *Format*

Choose **NetCDF**.

#### *(Set) Geometry*

This field should have the NetCDF ncase file name. Clicking button inserts file name shown in Selection field and inserts path information into Path field. File name can alternatively be typed into field.

#### *(Set) Measured*

Optional measured data field (see [Section , Two Step Load Data Reader](#)). (see [How To Read Data](#))

## PLOT3D Reader

*Example Source*

See the following directory for an example User-defined source code implementation this reader.

```
$CEI_HOME/ensight80/src/readers/plot3d/
```

*Overview Typical Two-Step Load*

Main Menu > File > Data (reader)... For basic details see the Data Reader portion of the [Two Step Load Data Reader](#) introduction, putting the PLOT3D grid file into the (Set) Geometry field and the results file (or PLOT3D Q-file) into the (Set) Results field.

*Extra Information*

PLOT3D reader extracts structured parts and iblanked unstructured parts essentially the same way as described in the basic structured reader (see [Reading and Loading Data Basics](#)).

Additionally to successfully read PLOT3D data, the following information must be known about the data:

1. format - ASCII, C binary, or Fortran binary
2. whether single or multizone
3. dimension - 3D, 2D, or 1D
4. whether iblanked or not
5. precision - single or double

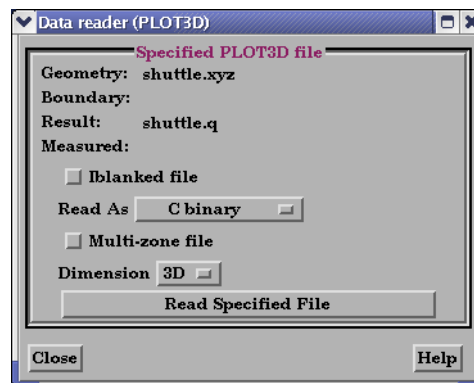

Figure 2-12  
Part Data Loader (PLOT3D)

EnSight attempts to determine these five settings automatically from the grid file. The settings that were determined (for the first four) are shown in the Part Builder dialog, where you can override them manually if needed.

The precision setting is not reflected in the dialog, but is echoed in the Server shell window. The q (or function) file precision will by default be set the same as that of the grid file. In the rare case where the automatic detection is wrong for the grid file or the precision is different for the q (or function) file than for the grid file, commands can be entered into the Command dialog to manually set the precision.

```
test: plot3d_grid_single      to read grid file as single precision
test: plot3d_grid_double     to read grid file as double precision
test: plot3d_qr_single       to read q (or function) file as single precision
test: plot3d_qr_double       to read q (or function) file as double precision
```

*(Set) Geometry*

Clicking this button inserts the Geometry file name shown in the Files Selection field and inserts the path information into the Path field. This file is a structured GRID file with FAST enhancements. The File name can alternatively be typed into field.

- (Set) Result* Clicking this button inserts the Results file name shown in the Files Selection field and inserts the path information into the Path field. The Results File is either a modified EnSight Results file or standard plot3d Q-file. Variable files (optional) are solution (PLOT3D Q-files) or function (FAST) files. The modified EnSight results file provides access to multiple solution files that are produced by time dependent simulations. The File name can alternatively be typed into field.
- (Set) Measured* Optional measured data field ([see Section , Two Step Load Data Reader](#)).
- (Set) Boundary* The optional boundary file defines boundary portions within and/or across structured blocks. (Note: this can be EnSight's boundary file format or a .fvbnd file.)  
(see [How To Read Data](#))

## RADIOSS Reader

### Overview

*Description*

Reads Radioss 4.x ANIM files.

### Data Reader

Main Menu > File > Data (reader)...

The File Selection dialog is used to specify which files you wish to read.

Access: Main Menu > File > Data (Reader)...

*Overview Typical  
Two-Step Load*

Main Menu > File > Data (reader)... For basic details see the Data Reader portion of the [Two Step Load Data Reader](#) introduction, putting the radioss file (named with suffix of "\*" or "??") to indicate a family of files) into the (Set) Geometry field.

*Overview Typical  
Quick Load*

Main Menu > File > Open... then user can select the desired file and Okay, and automatically load all the parts with all the default selections. For basic details see [Quick Load](#).

*Format*

Choose **RADIOSS\_4.x**.

*(Set) Geometry*

This field contains the first Radios file name in the series. Clicking button inserts file name shown in Selection field and inserts path information into Path field. File name can then be modified with an asterisk "\*" or question mark "???" to indicate the unique identifiers in the file series. File name can alternatively be typed into field.

*(Set) Measured*

Optional measured data field (see [Section , Two Step Load Data Reader](#)). (see [How To Read Data](#))



## SCRYU Reader

### Overview

*Description*

Reads FORTRAN binary SCRYU files (.PRE and .P files).

*Element*

*Limitations*

1) Doesn't read 4-noded tetrahedron type elements. This element will only be output from the SCRYU/Tetra for Windows solver. But it will be able to be read soon.

2) Doesn't read the following data in ".P"(result) file.

Surface data

FVEL:Nominal velocity vector value at cell surface center

Element surface center data

YPLS:y+ at cell surface center

HTRC:Coefficient of heat transfer at cell surface center

Rotational matrix

ROTM:Rotational matrix

3) Doesn't yet read adaptive mesh data.

*README*

See the following file for current information on this reader.

`$CEI_HOME/ensight80/src/readers/scryu/README_SCRYU`

*Overview Typical  
Two-Step Load*

Main Menu > File > Data (reader)... For basic details see the Data Reader portion of the [Two Step Load Data Reader](#) introduction, putting the geometry file (typically named with suffix .pre) into the (Set) Geometry field and then put the results file (typically named with a suffix .p).

*Overview Typical  
Quick Load*

Main Menu > File > Open... then user can select the desired file and Okay, and automatically load all the parts with all the default selections. For basic details see [Quick Load](#).

*Format*

Choose **SCRYU**.

*(Set) Geometry*

This field should have the .pre geometry file name. Clicking button inserts file name shown in Selection field and inserts path information into Path field. File name can alternatively be typed into field.

*(Set) Results*

This field should have the .p results file name. Clicking button inserts file name shown in Selection field and inserts path information into Path field. File name can alternatively be typed into field.

*(Set) Measured*

Optional measured data field (see [Section , Two Step Load Data Reader](#)). (see [How To Read Data](#))

## SILO Reader

### Overview

#### *Description*

The Silo reader can read .silo files directly or can read them using a Casefile which lists the geometry variable filenames, the timesteps and the constants all in one ASCII file. The .silo file contains both the geometry and the results.

#### *Library*

The Silo reader requires the Silo library version 4.2 or later. For information on Silo please see the following website:

<http://www.llnl.gov/bdiv/meshtv/software.html>

#### *SILO Casefile format*

The User Defined SILO Reader reads a restricted version of the EnSight Gold ASCII casefile as described below.

1. FORMAT  
type: - "silo" required
2. GEOMETRY  
model:
3. VARIABLE  
constant per case:
4. TIME (But only one of these!!!!)  
number of steps: - required  
time values: - required  
# Use the following if transient and  
# evenly spaced values  
filename start number:  
filename increment:  
# Use the following if transient and  
# list all values  
filename numbers:
5. All commands and options must start in first column. However, A space, newline, or # can be used in first column to indicate a comment line.

The following examples could be read by the user defined ensight gold reader

Example 1: A static model

```
-----
FORMAT
type:          silo
GEOMETRY
model:         example1.silo
VARIABLE
constant per case:  Density      .5
TIME
number of steps:   1
time values:       0.0
```

The following files would be needed for Example 1:

example1.silo

Example 2: A transient model

```
-----
FORMAT
type:          silo
GEOMETRY
model:         example2.*.silo   change_coords_only
VARIABLE
constant per case:   Density      .5
constant per case:   Modifier     1.0 1.01 1.025 1.04
1.055
TIME
number of steps:     5
time values:         .1 .2 .3 .4 .5
filename start number: 1
filename increment:  2
```

The following files would be needed for Example 2:

```
example2.1.silo
example2.3.silo
example2.5.silo
example2.7.silo
example2.9.silo
```

**README**

See the following file for current information on this reader.

\$CEI\_HOME/ensight80/src/readers/silo/README

*Overview Typical  
Two-Step Load*

Main Menu > File > Data (reader)... For basic details see the Data Reader portion of the [Two Step Load Data Reader](#) introduction, putting the SILO case file (typically named with suffix .case) into the (Set) Geometry field.

*Format*

To read Silo Case or Silo .silo files, choose **Silo**.

*(Set) Geometry*

This field should have the Silo Case file name or the .silo file. Clicking button inserts file name shown in Selection field and inserts path information into Path field. File name can alternatively be typed into field.

*(Set) Measured*

Optional measured data field (see [Section , Two Step Load Data Reader](#)). (see [How To Read Data](#))

## STL Reader

## Overview

<i>Description</i>	This reader will load STL files (either ASCII or binary). Note that STL files consist only of surfaces (triangles) and have no associated variables.
<i>Usefulness</i>	STL geometry format is widely compatible with a number of codes. Multiple STL files geometries can be created to represent scenery or background, then read in and scaled (using the -scaleg option) as a separate case to add to the presentation of your existing model results in EnSight.
<i>Usage</i>	The STL reader can read in an individual .stl file, or it can read in an exec file so that more than one stl file can be included in the same case.
<i>Limitations</i>	The current reader does not allow the coloring of each facet, nor does it allow coloring of each part, and just skips over color statements in the file.
<i>STL binary file format</i>	If the file is a binary STL (.stl) file, then it must contain exactly one part.
<i>STL ASCII file format</i>	If the file is an ASCII STL (.stl) file, then it can contain one or multiple parts. If you wish to read in multiple files  Single file multipart ASCII format is as follows:  <pre> solid part1     ... endsolid part1 solid part2     ... endsolid part2 </pre>
<i>Exec file format</i>	An exec file is used to read in multiple STL files into one case. Because binary STL can contain only one part, if you wish to read in more than one binary STL file into a single case, then you must use an exec file. ASCII STL files with one or multiple parts can be read in to a single case using the exec file. An exec file can read in binary and ASCII files together into a single case. This exec file is a very simple ascii file that must conform to the following:  <ol style="list-style-type: none"> <li>1. All lines must begin in column 1</li> <li>2. No blank or comment lines allowed</li> <li>3. If the stl filenames begin with a "/", it will be treated as absolute path. Otherwise, the path for the exec file will be prepended to the name given in the file. (Thus, relative paths should work).</li> </ol> <pre> line 0:    numfiles: N    (where N is the no. of files) line 1-n:  stlfilename1 . . . . . . stlfilenameN </pre>
<i>Example Exec file</i>	<pre> numfiles: 3 CASTLE.STL bincastle.stl test.slp </pre>

<i>README</i>	See the following file for current information on this reader.  \$CEI_HOME/ensight80/src/readers/stl/README
<i>Overview Typical Two-Step Load</i>	Main Menu > File > Data (reader)... For basic details see the Data Reader portion of the <a href="#">Two Step Load Data Reader</a> introduction, putting the geometry file (typically named with suffix .stl) or the exec file (typically named with the suffix .xct) into the (Set) Geometry field.
<i>Overview Typical Quick Load</i>	Main Menu > File > Open... then user can select the desired file and Okay, and automatically load all the parts with all the default selections. For basic details see <a href="#">Quick Load</a> .
<i>Format</i>	To read STL .stl or STL .xct files, choose <b>STL</b> .
<i>(Set) Geometry</i>	This field should have the .stl or .xct file name. Clicking button inserts file name shown in Selection field and inserts path information into Path field. File name can alternatively be typed into field.
<i>(Set) Measured</i>	Optional measured data field (see <a href="#">Section , Two Step Load Data Reader</a> ). (see <a href="#">How To Read Data</a> )

## Tecplot Reader

### Overview

#### *Description*

There are two Tecplot readers included with EnSight: Tecplot which reads Tecplot binary 7 files, and Tecplot\_ASCII which reads Tecplot ASCII 10 files.

#### *TECPLOT 7 Binary Reader Usage*

The TECPLOT binary file format uses a Tecplot case file or a plt file.

1. Coordinates are the first three variables in data beginning with x, y, and z (upper or lower case).
2. If no variables begin with x or y, then coordinates are generated for block or point data (not for finite element data). Note: This behavior may be modified by a case file as described below.
3. All data in file is at the same time step, i.e., multiple zones are assumed to be multiple blocks/parts.
4. Multiple files with the same pattern, e.g., name\*.plt, are assumed to be individual timesteps of the same simulation.

Example: entering "airfoil?.plt" or "air\*.plt" in the Data Reader dialog will load all of the files below. (Remember to select the Tecplot format from the drop-down list.)

```
airfoil1.plt      airfoil4.plt      airfoil7.plt
airfoil2.plt      airfoil5.plt      airfoil8.plt
airfoil3.plt      airfoil6.plt      airfoil9.plt
```

5. The user may explicitly identify variables to be used as the coordinate axes in a "case file." Two keywords are allowed in the case file: model and coordinate. A simple file will look like the example below.

```
File airfoil.case
model: airfoil*.plt
coordinate: x 1 X-coord
coordinate: y 2 Y-coord
(end of file)
```

The model keyword gives the filename or filename pattern to use when reading data. The coordinate keyword tells EnSight which variables to use for the coordinates. The first argument after the keyword gives the direction (x, y, or z). The second argument gives the variable number, and the third argument is a user supplied name for the variable. In the example above, no z coordinate is defined because this is a 2-D problem.

#### *Tecplot ASCII Reader*

The Tecplot 10 ASCII format is read using the Tecplot\_ASCII reader.

#### *README*

See the following directory for current information on these readers.

```
$CEI_HOME/ensight80/src/readers/tecplot/
```

#### *Overview Typical Load*

Main Menu > File > Data (reader)... For basic details see the Data Reader portion of the [Two Step Load Data Reader](#) introduction, putting the Tecplot 7 binary file (typically named with a suffix .plt), or the Tecplot 10 ASCII file (typically named

with a suffix .dat) into the (Set) Geometry field, choose the corresponding format (TECPLOT or Tecplot\_ASCII) and then load the parts.

<i>Format</i>	To read Tecplot 7 binary files, choose the <b>TECPLOT</b> and to read Tecplot 10 ASCII files, choose the <b>Tecplot_ASCII</b> reader.
<i>Specify Starting Time Step</i>	Specify starting time step. If not specified, EnSight will load the last step.
<i>Binary Files</i>	This field is ignored as the TECPLOT Binary reader automatically checks endian status.
<i>(Set) Geometry</i>	This field should have the .dat file name for ASCII data and the .plt name for binary data. Clicking button inserts file name shown in Selection field and inserts path information into Path field. File name can alternatively be typed into field.
<i>(Set) Measured</i>	Optional measured data field ( <a href="#">see Section , Two Step Load Data Reader</a> ). (see <a href="#">How To Read Data</a> )

## Vectis Reader

### Overview

#### *Reader Visibility Flag*

By default, this reader is not loaded into the list of available readers. To enable this reader go into the Menu, Edit > Preferences and click on Data and toggle on the reader visibility flag.

#### *Reader vs. Translator*

This reader is designed for files written before Vectis 3.6. For versions 3.6 or later, we recommend using a translator to convert the POST data into EnSight Case format (for more details, see our FAQ on our website [www.ensight.com/FAQ/faq.0024.html](http://www.ensight.com/FAQ/faq.0024.html)).

#### *Pre-version 3.6 Description*

This reader inputs either .TRI or .POS datasets as follows

Single TRI file - Gives the CAD geometry, but no variables (If you must see this along with your POST data, will have to read it as a second case), for example, CYLINDER.TRI

Single POST file WITH NO \*'s in the name - Gives the geometry and variables in the post file, including surface patches and particles.

Multiple POST files - Enter a filename WITH \*'s in the name

Gives the geometry and variables in the post files, which match the asterisks in a sequentially increasing pattern (starts at 1, increases by 1). Note: If your naming/numbering scheme is different than this, we require you to rename/renumber.

```
ex1) CYLINDER.POS.**      matches:
CYLINDER.POS.01      CYLINDER.POS.02      CYLINDER.POS.03
```

```
ex2) myfile***.pos      matches:
myfile001.pos      myfile002.pos
```

#### *Query over time*

Query node over time operation within EnSight will only work for cell variables on the cell part. Patch and drop variables will currently return all zeros.

#### *Cell Variables*

You may request cell variables on patch or droplet parts. The cell variable will be mapped onto them. BUT, be aware that any portions of the patches which are actually in the "external" cells will have zero values, because VECTIS doesn't contain that info directly. This leads to slightly "streaked" or "blotched" models which basically show the variable, but are probably not presentation quality. In order to eliminate this effect, neighboring cell information will need to be accessed - and at this time that work has not been done. Consider using EnSight's Offset Variable capability - it might be useful for certain models.

#### *README*

See the following file for current information on this reader.

```
$CEI_HOME/ensight80/src/readers/vectis/README
```

#### *Overview Typical Two-Step Load*

Main Menu > File > Data (reader)... For basic details see the Data Reader portion of the [Two Step Load Data Reader](#) introduction, putting the pre 3.6 Vectis geometry file (typically named with suffix .tri or .pos) into the (Set) Geometry field.

#### *Format*

Choose **Vectis**.

#### *(Set) Geometry*

This field should be written by a Vectis version earlier than 3.6 and have a .TRI or .POS suffix.. Clicking button inserts file name shown in Selection field and inserts path information into Path field. File name can alternatively be typed into field.

#### *(Set) Measured*

Optional measured data field ([see Section , Two Step Load Data Reader](#)).  
(see [How To Read Data](#))



## 2.4 Other External Data Sources

### External Translators

Translators supplied with the EnSight application enable you to use data files from many popular engineering packages. These translators are found in the translators directory on the EnSight distribution CD. A README file is supplied for each translator to help you understand the operation of each Particular translator. These translators are not supported by CEI, but are supplied at no-cost and as source files, where possible, to allow user modification and porting.

### Exported from Analysis Codes

Several Analysis codes can export data in EnSight file formats. Examples of these include Fluent, STAR-CD, CFX and others.

## 2.5 Command Files

Command files contain EnSight command language as ASCII text that can be examined and even edited. They can be saved starting at any point and ending at any point during an EnSight session. They can be replayed at any point in an EnSight session. However, *some command sequences require a certain state to exist*, such as connection to the Server, the data read, or a Part created with a Particular Part number.

There are a multitude of applications for command files in EnSight. They include such things as being able to play back an entire EnSight session, easily returning to a standard orientation, connecting to a specific host, creating Particle traces, setting up a keyframe animation, etc. Anything that you will want to be able to repeatedly do is a candidate for a command file. Further, if it is a task that you frequently do, you can turn the command file into a macro (see To Use Macros below).

### *Saving command file*

The command file which will repeat the entire current session can be saved from the menu as follows: Main Menu> File > Save > Commands from this session... This command file can then be replayed at startup of a new EnSight session and will redo step by step each of the commands.

### *Documenting Bugs*

Command files are one of the best ways of documenting any bugs found in the EnSight system. Hopefully that is a rare occasion, but if it occurs, a command file provided to CEI will greatly facilitate the correction of the bug.

### *Nested Command Files*

Command files can be nested, which means that if you have a command file that does a specific operation, you can play that command file from any other command file, as long as any prerequisite requirements are completed. This is done by adding the command `play: <filename>` in the command file.

### *Default Command File*

EnSight is always saving a command file referred to as the *default command file* (unless the you have turned off this feature with a Client command line option). This command file can be saved (and renamed) when exiting EnSight, as described later in this section. The default command file is primarily intended to be a crash recovery aid. If something unforeseen were to prematurely end your EnSight session, you can recover to the last successfully completed command by restarting EnSight and running the default command file. Saving the Default Command File for EnSight Session

## Command dialog



Figure 2-13  
Command dialog

You use the Command dialog to control the execution of EnSight command language. The language can be entered by hand, or as is most often the case, played from a file. This dialog also controls the recording of command files as well as Macro path definition.

Access: Main Menu > File > Command...

<i>Command History</i>	Displays most recent command language executed (or recorded). Can click on an entry which will bring entry to the Command Entry field.
<i>Command Entry</i>	Command language entry. Enter command and press RETURN. During file playback, next command to be executed is shown here. Any command preceded by a # is a comment line.
<i>Record</i>	Select to start play file recording. Will be prompted for file name. Can simultaneously record and play files. When engaged, all actions in EnSight are recorded to the specified file.
<i>Record Part Selection By</i>	Select the method by which parts will be recorded in the command language - either by Number (default) or by Name.
<i>Play</i>	Select to start playing a command file. You must provide the command language file name. Command play continues as long as there are commands in file, an interrupt: command has not been processed, or the Interrupt button has not been pressed.
<i>Interrupt</i>	Interrupt playback of the command file.
<i>Step</i>	Step through commands of play file. File playback must be stopped. Each click will execute next command shown in Command Entry field.
<i>Skip</i>	Skip over the playing command file's next command (shown in Command Entry box).
<i>Continue</i>	Continue playing interrupted command file.
<i>Delay Between Commands</i>	Set the delay between commands in seconds when playing a command file.
<i>Delay Refresh</i>	When enabled, will cause the EnSight graphics window to refresh only after the playfile processing has completed or has been interrupted by the user.
<i>Reload Macros</i>	Causes the Macro definitions to be reread from the site preferences directory and from the user's .ensight8 directory.

### Troubleshooting Command Files

This section describes some common errors when running commands. If an error is encountered while playing back a command file you can possibly retype the command or continue without the command.

Problem	Probable Causes	Solutions
Error in command category	Incorrect spelling in the command category	Check and fix spelling
Command does not exist	Incorrect spelling in the command	Check and fix spelling
Error in parameter	Incorrect integer, float, range, or string value parameter	Fix spelling or enter a legal value
Commands do not seem to play	Command file was interrupted by an error or an interrupt command	Click continue in the Command dialog

(see [How To Record and Play Command Files](#))

### Saving the Default Command File for EnSight Session

EnSight is always saving a command file referred to as the *default command file* (unless the you have turned off this feature with a Client command line option). This default command file receives a default name starting with “ensigAAA” and is written to your /usr/tmp directory (unless you set your TMPDIR environment variable). This command file can be saved (and renamed) when exiting EnSight. If you do not save this temporary file in the manner explained below, it will be deleted automatically for you when you Quit normally from EnSight.

#### Quit Confirmation dialog

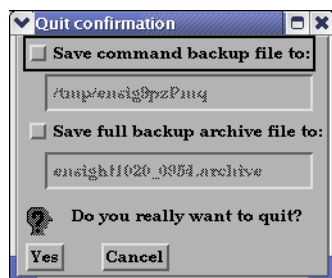

Figure 2-14  
Quit Confirmation dialog

You use the Quit Confirmation dialog to save either or both the default command file and an archive file before exiting the program.

Access: Main Menu > File > Quit...

#### Save Command Backup File To:

Toggle-on to save the default command file. Can also specify a new name for the command file. (see [Section 2.5, Command Files](#) for more information on using command files.)

#### Save Full Backup Yes

Toggle-on and specify a name to create a Full Backup file.  
Click to save the indicated files and terminate the program.

(see [How To Record and Play Command Files](#))

### *Auto recovery*

While EnSight is running, an auto recovery command file, `recover.enc`, is written to the `.ensight8` directory. If EnSight crashes for some reason, this temporary file is not deleted. When EnSight is restarted (without using a play file) the user will be prompted with the option of using the auto recover command file.

*Auto recovery dialog*

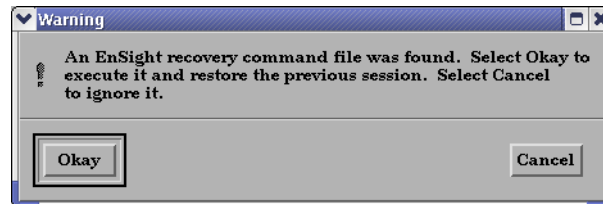

Figure 2-15  
Auto recovery dialog

## 2.6 Archive Files

### *Saving and Restoring a Full backup*

The current state of the EnSight Client and Server host systems may be saved to files. An EnSight session may then be restored to this saved state after restarting at a later time. A Full Backup consists of the following files. First, a small archive information file is created containing the location and name of the Client & Server files that will be described next. Second, a file is created on the Client host system containing the entire state of the Client. Third, a file is created on each Server containing the entire state of that Server. You have control over the name and location of the first file, but only the directories for the other files.

Restoring EnSight to a previously saved state will leave the system in exactly the state EnSight was in at the time of the backup. For a restore to be successful, it is important that EnSight be in a “clean” state. This means that no data can be read in before performing a restore. During a restore, any auto connections to the Server(s) will be made for you. If manual connections were originally used, you will need to once again make them during the restore. (If more than one case was present when the archive was saved, then connection to all the Servers is necessary).

An alternative to a Full Backup is to record a command file up to the state the user wishes to restore at a later date, and then simply replaying the command file. However, this requires execution of the entire command file to get to the restart point. A Full Backup returns you right to the restart point without having to recompute any previous actions.

A Full Backup restores very quickly. If you have very large datasets that take a significant time to read, consider reading them and then immediately writing a Full Backup file. Then, use the Full Backup file for subsequent session instead of reading the data.

***Important Note:*** *Archives are intended to facilitate rapid reload of data and context and are NOT intended for lon-term data storage. Therefore, archives are likely NOT compatible between earlier EnSight versions and the current version (see Release Notes for details). If EnSight fails to open an archive, it will state that it failed and will write out a .cmd file and echo its location. As command files ARE often compatible between earlier and later versions, the .cmd file can likely be used to retrace the steps of the dataset.*

### Save Full Backup Archive dialog

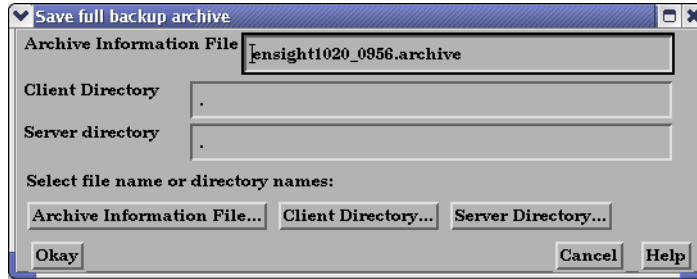

Figure 2-16  
Save Full Backup Archive dialog

You use the Save Full Backup Archive dialog to control the files necessary to perform a full archive on EnSight.

Access: Main Menu > File > Backup > Save Full Backup...

*Archive Information File*

Specifies name of Full Backup control file.

*Client Directory*

Specifies the directory for the Client archive file.

*Server Directory*

Specifies the directory for the Server archive file.

*Archive information File...*

Click to display the file selection dialog for specifying the Archive Information File.

*Client Directory...*

Click to display the file selection dialog for specifying the Client Directory.

*Server Directory...*

Click to display the file selection dialog for specifying the Server Directory (for the selected case if there is more than one). Choose a common path if there is more than one.

*Okay*

Click to perform the full backup.

*NOTE: This command is written to the command file, but is preceded with a # (the comment character). To make the archive command occur when you play the command file back, uncomment the #.*

(see [How To Save and Restore an Archive](#))

### File Selection for Restarting from an Archive

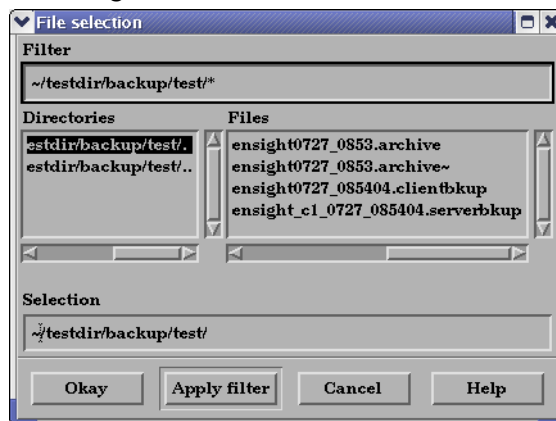

Figure 2-17  
File Selection for Restarting from an Archive

You use the Restore Full Archive Backup dialog to read and restore a previously stored archive file.

Access: Main Menu > File > Backup > Restore Full...

*Troubleshooting Full Backup*

Problem	Probable Causes	Solutions
Error message indicating that all dialogs must be dismissed	When saving and restoring archives, all EnSight dialogs, except for the Client GUI, must be dismissed to free up any temporary tables that are in use. Temporary tables are not written to the archive files.	Dismiss all the Motif dialogs except the main Client GUI.
Backup fails for any reason	Ran out of disk space on the Client or Server host system	Check the file system you are writing to, on both the Server and the Client host systems, with the command “df” then remove any unnecessary files to free up disk space.
	Directory specified is not writable	Change permissions of destination directory or specify alternate location.



## 2.7 Context Files

EnSight context files can be used to duplicate the current EnSight state with the same or a different, but similar, dataset. The context file works best if the dataset it is being applied to contains the same variable names and parts, but can also be used when this is not the case.

Input and output of context files is described below as well as in [How To Save or Restore a Context File](#) and under Save and Restore of [Section 6.1, File Menu Functions](#)

### Saving a Context File

To save the current context, simply entered the desired file name in the dialog under: Access: File > Save > Context...

(and if you have multiple cases to save, select Save All Cases)

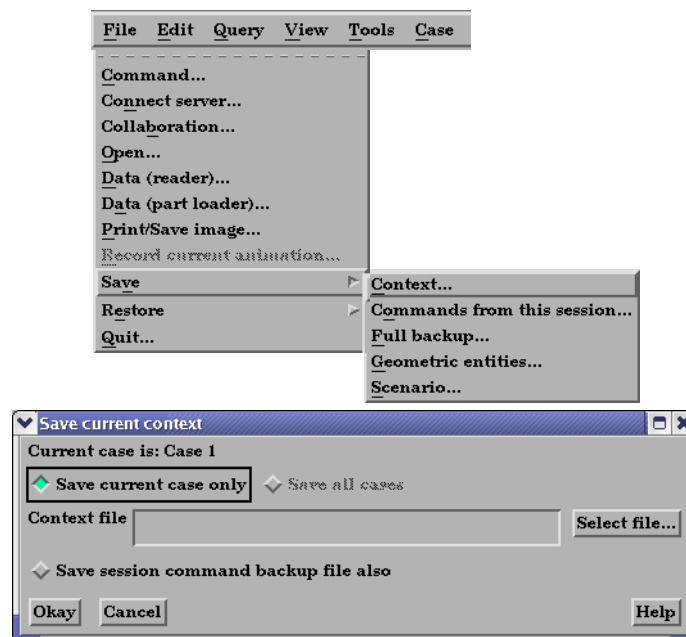

Figure 2-18  
Saving a Context File

### Restoring a Context

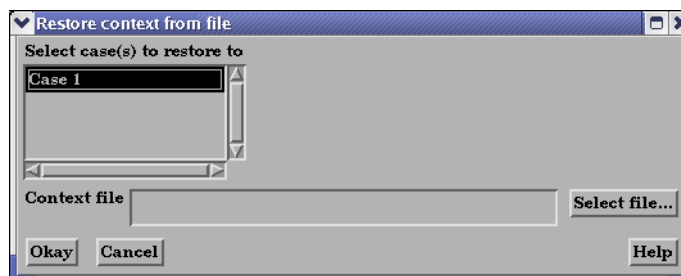

Figure 2-19  
Restoring a Context File

If you are restoring a context file containing information for a single case, you can select the case or cases that you wish to apply the context to. If you are restoring a context file containing information about multiple cases, the selection list will be ignored.

When restoring a context you can 1) read the new dataset and build the new parts and then restore the context file, or 2) read the new dataset, close the part builder without building any parts and restore the context file (whereupon the context file will build the same parts as existed when it was saved) or 3) restore the context before reading any data (whereupon the previous state with the same dataset will be restored). The way you decide to do this depends upon whether the same parts exist in the new dataset.

If the same parts do not exist, you would typically read the new dataset and build the desired parts in the normal way. Then:

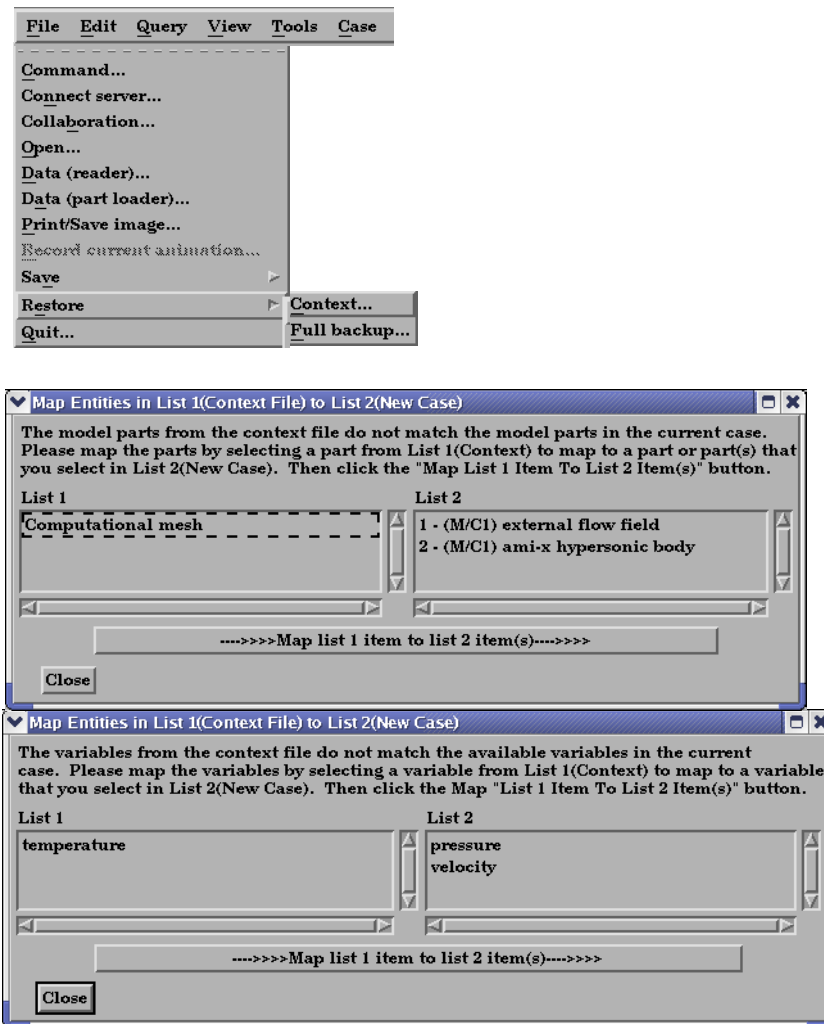

Figure 2-20  
Restoring a Context

Flipbook animations are not restored using the context file because it is unknown at the time the context file is created what state existed when the flipbook was saved.

Context files use EnSight's command language and other state files (such as palette, view, and keyframe animation).

## 2.8 Scenario Files

Scenario files are used by CEI's EnLiten product which is capable of viewing all geometry (such as parts, annotation, plots, etc.) that EnSight can display, including flipbook, keyframe, and particle trace animations.

A "scenario" defines all visible entities you wish to view with EnLiten and includes any saved views and notes that you want to make available to the EnLiten user.

When you create a scenario, the following may be saved: (a) EnLiten file containing geometric display information, saved views, and attached nodes. (b) A palette file for each visible variable legend. (c) A JPEG image file (not used by EnLiten). (d) A scenario description file (not used by EnLiten). (e) A EnSight context file (not used by EnLiten).

When saving a scenario, either the scenario file itself can be saved, or the scenario project - which includes all of the files in the previous paragraph.

EnLiten is a geometry viewer only. As such it is not capable of creating or modifying any new/existing information such as variables or parts, or of changing timesteps.

Since EnLiten is only a geometry viewer, only keyframe transformation information is stored when saving a scenario file, i.e., no transient data keyframing is possible (consider loading a flipbook instead)

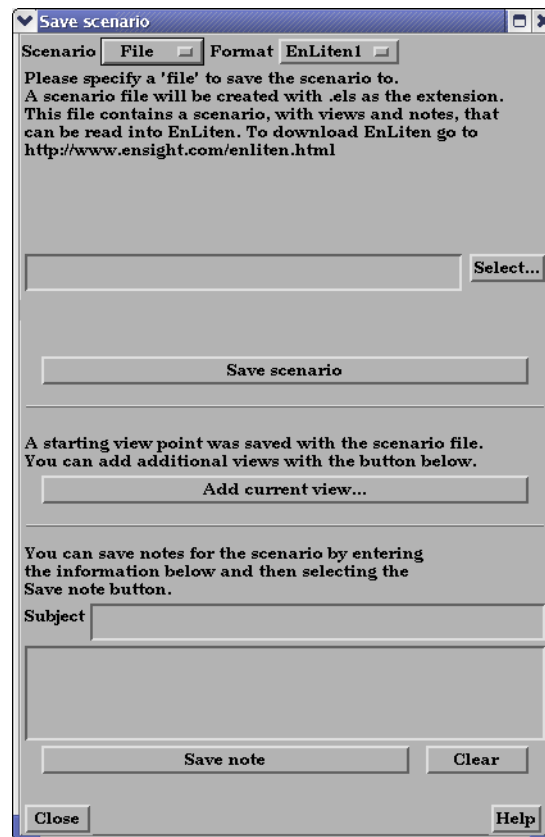

Figure 2-21  
Save Scenario Dialog

## 2.8 Scenario Files

You use the Save Scenario dialog to control the options of the scenario files to be saved in EnSight for display in EnLiten.

Access: Main Menu > File > Save > Scenario...

<i>Scenario</i>	<i>Project</i> - will save the scenario file plus files mentioned on the previous page. <i>File</i> - will save only the scenario file.
<i>Scenario Directory/ File</i>	Specifies the directory or file to which the scenario information will be written.
<i>General Description</i>	Specifies the general description which will be used when a html page is generated for the scenario.
<i>Save Keyframe Animation Toggle</i>	Select to have any currently defined keyframe animation sequence saved to the scenario.
<i>Save Flipbook Animation Toggle</i>	Select to have any currently defined flipbook animation saved to the scenario.
<i>Save Particle Trace Animation Toggle</i>	Select to have any currently defined particle trace animation saved to the scenario.
<i>Save Scenario</i>	Click to actually save the scenario.
<i>Add Current View...</i>	After the scenario has been saved you may save additional views by setting the desired view in EnSight, then selecting this button. You will be asked to name the view in a resulting pop-up dialog.
<i>Save Note</i>	After the scenario has been saved you may write notes regarding the scenario by entering a Subject line and typing in the notes input area. When satisfied, select this button.  (see <a href="#">How To Save Scenario</a> )

## 2.9 Saving Geometry and Results Within EnSight

### Saving Geometric Entities

Sometimes you may wish to output geometric data or variable values from EnSight to be included in a different analysis code, or to be used in a presentation.

EnSight has three internal writers that allow saving geometric data and variable values in Brick of Values, Case (EnSight Gold) or VRML. EnSight also allows the user to create their own writers. Each user-defined writer must be compiled into a dynamic shared library that is loaded at runtime and listed in the Save Geometric Entities dialog with the internal writer formats.

Both internal and user-defined writers have access only to the geometry of selected parts and each of their active variables. Only parts located on the server can be saved. This includes all original model parts, and the following created parts: 2D-clips, Elevated Surfaces, Developed Surfaces, and Isosurfaces. The VRML internal writer saves all the visible parts on the server (thus, particle traces, vector arrows, contours, etc. will not be saved) in their current visible state except for Parts which have limit fringes set to transparent. The VRML file will be saved on the client.

The user-defined writers can call the routines of an EnSight API to retrieve, to get, for example, nodal coordinates, node ids, element ids of parts selected in the Parts window to be passed by value to be used, manipulated and/or written out in any format desired. User-defined writer dialog includes a Parameter field that allows passing in a text field into the writer from the GUI for extra options.

Several example writers (including source code header files, Makefile and the corresponding shared library) are included to demonstrate this capability.

The Case (Gold) Lite reader is included to demonstrate how to exercise most of the API and output a subset of the Case (Gold) format. Complex numbers and custom Gold format are not supported with this writer. While the writer is not compiled, the source code of this writer, the required header files, and the Makefile are included.

The Flatfile user-defined writer is designed to demonstrate the output selected part nodal data (coordinates & IDs) as well as active variable values (scalar and/or vector only) data in a comma delimited format easily imported into other applications. If any of the keywords 'ANSYS' or 'force' or 'body' is entered into the Parameter field, then Flatfile will output an ANSYS body force file.

The HDF 5.0 writer is designed to write out selected parts and their corresponding active variables using the HDF 5.0 API which is compatible with the EnSight HDF user-defined reader.

The STL user-defined writer is designed to write out the border geometry in the form of triangular 2D elements of the selected part(s) at the beginning timestep. The end time and the step time are ignored. The STL format does not support multiple parts in a single binary file, but does support multiple parts in a single ASCII file. Therefore, if multiple parts are selected and ascii is checked, the STL writer outputs an ascii file with the border of each of the parts. If multiple parts are selected and binary is checked, the STL writer outputs a binary file containing a single border of the multiple parts.

More user-defined writers may be distributed with EnSight in the future.

## Save Geometric Entities dialog

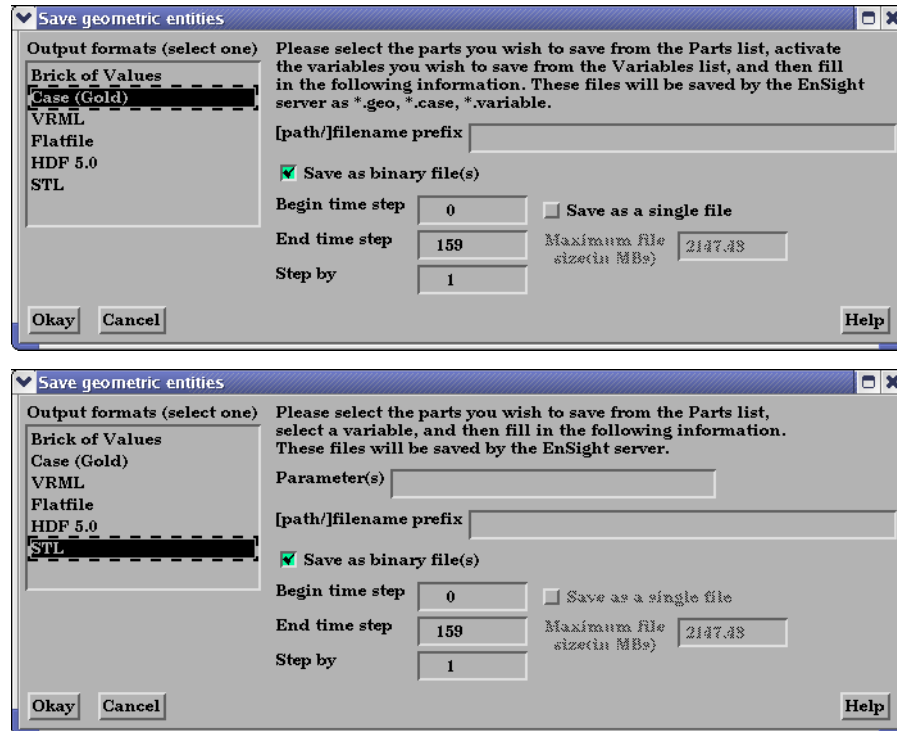

Figure 2-22

Save Geometric Entities dialog  
(Showing Case (Gold) internal writer, and STL external writer)

The Save Geometric Entities dialog is used to save Selected Model, 2D-Clip, Isosurface, Elevated Surface, and Developed Surface Parts as EnSight Case (Gold) files. Thus modified model Parts and certain classes of created Parts can become model Parts of a new dataset.

Access: Main Menu > File > Save > Save Geometric Entities...

<b>Output Format</b>	Specify the desired format: Case(EnSight Gold), VRML, Flatfile, HDF5.0, STL, etc.
<b>Parameter</b>	Allows passing a text field from the GUI to the writer for extra options. Some writers make use of this field to modify their behavior (see Flatfile, for example) while others ignore this field.
<b>[path]/filename prefix</b>	Specify path and filename prefix name for the saved files. For Case(Gold) the saved geometry file will be named filename.geo, the casefile will be filename.case, and the active variables will be filename.variable. The VRML file will be filename.wrl. The other writers will vary.
<b>Save As Binary File(s)</b>	Save as Binary File(s) specifies whether to save the data in ASCII (button toggled off - default) or binary (button toggled on) format. Writers vary in their handling of this.
<b>Begin Time Step</b>	Begin Time Step field specifies the initial time step for which information will be available to save for all selected Parts and activated variables. Writers may vary in their usage of this information.
<b>End Time Step</b>	End Time Step field specifies the final time step for which information will be saved for all selected Parts and activated variables. Writers may vary in their handling of this.
<b>Step By</b>	Step By field specifies the time step increment for which information will be saved for all selected Parts and activated variables starting with Begin Time Step and finishing with End Time Step. The Step By value MUST be an integer. Writers may vary in their handling of this.

<i>Save as a Single File</i>	Toggle on to have a single file per variable - containing all values for all time steps for that variable. The default is to have a file per variable per time step. Writers may vary in their handling of this.
<i>Maximum file Size</i>	For Single File option, can specify the maximum file size. Continuation files are created if the file size would exceed this maximum. Writers may vary in their handling of this.
<i>Okay</i>	Click ok to pass the GUI values to the selected writer, and begin executing the writer routine

### *Troubleshooting Saving Geometric Entities*

Problem	Probable Causes	Solutions
A Part was not saved	User attempted to save an unsupported Part type.	Select only Model, Isosurface, 2D-Clip, and Elevated Surface Parts.
Variable(s) not saved	The variable was not activated or the variable was a constant.	Activate all scalar and vector variables you want saved.
Error saving	File prefix indicates a directory that is not writable or disk is out of space.	Re-specify a writable directory and valid prefix name. Remove unneeded files.
My custom user-defined writer doesn't show up on list of formats	Didn't load at startup	Start EnSight with <code>-writerdbg</code> option EnSight loads user-defined writers at startup from shared libraries found in <code>\$CEI_HOME/ensight80/machines/\$CEI_ARCH/lib_writers</code> If your user-defined writer is not in the default directory, tell EnSight where to find it by: <code>setenv ENSIGHT8_UDW location</code>

(see [How To Save Geometric Entities](#))

## 2.10 Saving and Restoring View States

EnSight's viewports provide a great deal of flexibility in how objects are displayed in the Graphics Window. Given the complicated transformations that can be performed, it is imperative that users be able to save and restore accumulated viewport transforms.

View saving and restoring is accessed from the Transformations dialog.



Figure 2-23  
View Saving and Restoring in Transformation Dialog

Access: Desktop > Transformation Edit... > File

When either the Save View... or Restore View... selection is made, the user is presented with the typical File Selection dialog from which the save or restore can be accomplished. Save and Restore work on a single viewport.

(see also [How To Save and Restore Viewing Parameters](#))



## 2.11 Saving and Printing Graphic Images

EnSight enables you to save an image of the Main View to a disk file or send it directly to a printer. The choice of save file formats depends on the implementation, but in all cases it is possible to obtain formats compatible with printers and plotters. Currently EnVideo, Apple PICT, PCL, PostScript, SGI RGB, CEI RGB(w/depth), TIFF, JPEG, MPEG, AVI, and TARGA formats are available.

EnSight also enables you to save images of an animation to disk files. These files can then be converted and printed or recorded to video equipment (see [Section 7.3, Keyframe Animation](#)).

### *Print/Save Image dialog*

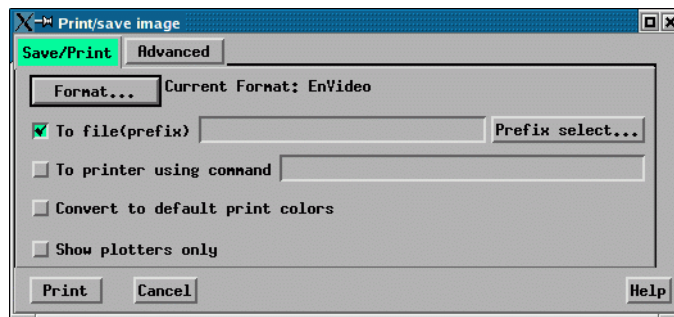

Figure 2-24  
Print/Save Image dialog

You use the Print/Save Image dialog to specify the format and destination of an image to save. The destination can be a disk file or a printer. You also access the Image Format Options dialog for the various types from this dialog.

Access: Main Menu > File > Print/Save Image...

<i>Format...</i>	Click to select image format. (See next figure)
<i>To File Toggle/Field</i>	The image will be saved to this disk file name if toggle is on. This is a filename prefix. An appropriate suffix, according to the file format chosen, will be added.
<i>To Printer Using Command Toggle/Field</i>	The command to send a file to the printer if toggle is on. Make sure your printer is setup for the format you've selected.
<i>Convert to default print colors</i>	Clicking this toggle on will convert all black to white and all white to black but will leave all other colors as they are.
<i>Show Plotters Only</i>	Clicking this toggle will cause the graphics window to only display plotters.
<i>Print</i>	Click this button when all options are correctly specified and you are ready to print.

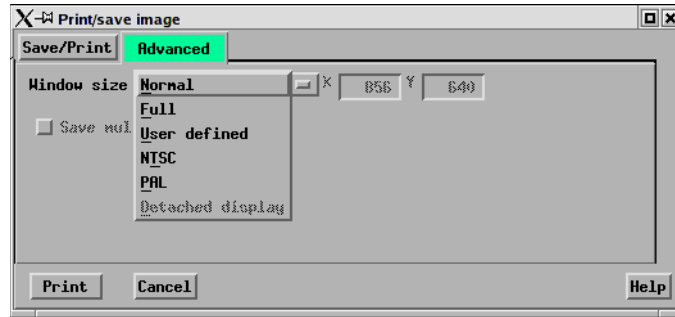

Figure 2-25  
Print/Save Image Advanced dialog

<b>Window Size</b>	Specifies the size of the Graphics Window and the resulting image size.
Normal	Creates a window which is the size of the current Graphics Window.
Full	Creates a window which is the size of the full screen.
User Defined	Creates a window which is specified in terms of its width and height in the X and Y fields.
NTSC	Creates a window which is specified in terms NTSC standard window size (704 x 480).
PAL	Creates a window which is specified in terms of PAL standard window size.
Detached Display	Uses the detached display (as specified with - dconfig option) as the source for the output.

Format...

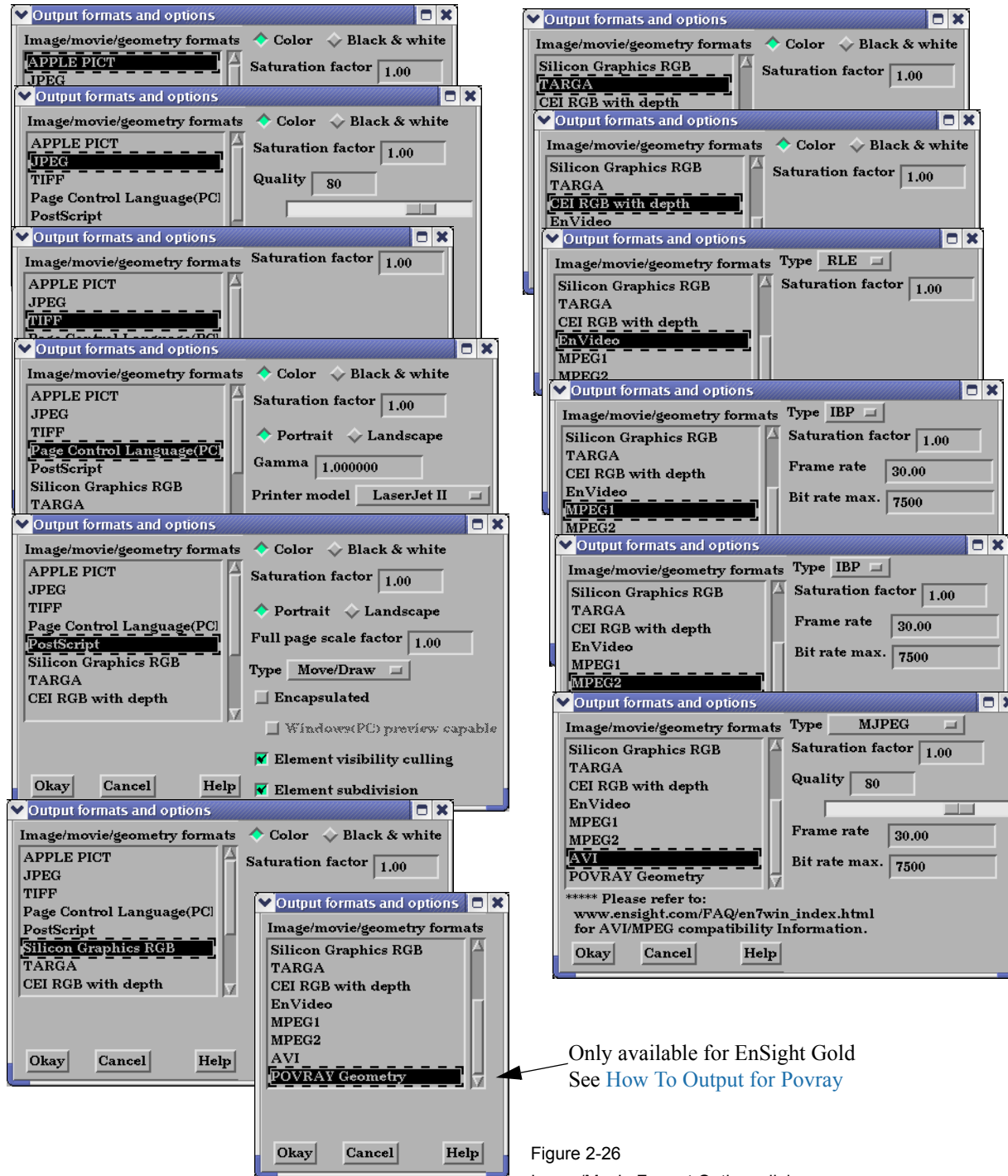

Figure 2-26  
Image/Movie Format Options dialogs

*Color/Black & White*  
(Several Formats)

Color versus Black and White toggle.

*Saturation Factor*  
(all formats)

At a value of 1.0, no change to the image. At lower values, a proportionate amount of white is added to each pixel. At a value of 0.0, the image would be all white.

*Quality (JPEG)*

Specifies trade-off between fidelity & compression. 100 max fidelity; 0 max compression.

## 2.11 Saving and Printing Graphic Images

<i>Portrait/Landscape (PCL, Postscript)</i>	Page Orientation for printing.
<i>Gamma (PCL)</i>	Gamma correction factor.
<i>Full Page Scale Factor (Postscript)</i>	The percentage of full page scaling to do. This is according to Orientation as well. Values are from 0.0 to 1.0.
<i>Printer Model (PCL)</i>	The destination PCL printer model.
<i>Type (Postscript)</i>	Type of Postscript output: Move/Draw (vector) or Image Pixels. If type is Image Pixels, shaded 3D objects will be output as pixels while overlay graphics (annotation text, plots, color legends) will be output Move/Draw for higher print quality.
<i>Type (EnVideo)</i>	Type of EnVideo output: Run Length Encoded or Jpeg.
<i>Encapsulated Toggle (Postscript)</i>	Generate Encapsulated PostScript (EPS) for importing into other applications. (The graphic typically will appear as a gray box in the importing application on all systems unless the Windows(PC) Preview Capable toggle is also On).
<i>Windows(PC) Preview Capable Toggle</i>	Create an Encapsulated PostScript (EPS) file which also has a preview image for use in Windows® applications. (The graphic will still appear as a gray box in the importing application on Macintosh systems).
<i>Element Visibility Culling Toggle (Postscript)</i>	Hidden geometry will be removed from the output stream if toggle is on. Valid for Move/Draw output only. On by default.
<i>Element Subdivision (Postscript)</i>	Subdivide output primitives (lines and polygons) if toggle is on. Although the output file will be larger, the color distribution will be far superior. Valid for Move/Draw output only. On by default.

(see [How To Print/Save an Image](#))

*Troubleshooting Saving an Image*

Problem	Probable Causes	Solutions
Image has blotches or ghosts of other windows in it	A viewport or menu was popped in front of the Main Graphics Window as the image was being saved.	Do not perform any window manager functions until image is finished recording to disk file.
Error while saving image file	Directory or file specified is not writable	Rename the file or change the permissions.
	Ran out of disk space	Check the file system you are writing to with the “df” command then remove any unnecessary files to free up disk space.
	Image format not selected	Select an image format before saving.
Image looks bad when printed	Original on-screen image has low resolution	Make the graphics window as large as possible before saving the image to increase the number of RGB pixels used on the display.
	Image has been dithered during processing	Do not enlarge or reduce the image until it is in your word processor.
	Non-integral ratio of printer resolution to image resolution at final size	The image is a pixel-map image. For best results, the number of printer-dots per image-dot should be an integer. For example, if the original image resolution is 72 dpi, reduced to 48% the final-size resolution is $72/.48 = 150$ dpi. On a 600 dpi printer, each image pixel is exactly 4 printer-dots on a side.
Move/Draw PostScript output doesn't look correct.	Primitives in Move/Draw PostScript output sometimes suffer from sorting problems.	Use Image Pixel type instead of Move/Draw.

(see [How To Print/Save an Image](#))

## 2.12 Saving and Loading XY Plot Data

The xy data used for curves in EnSight's plotter can be saved to a file for future re-loading into EnSight or for use in other plotting packages.

The process is described below as well as in [Section 7.5, Query/Plot](#)

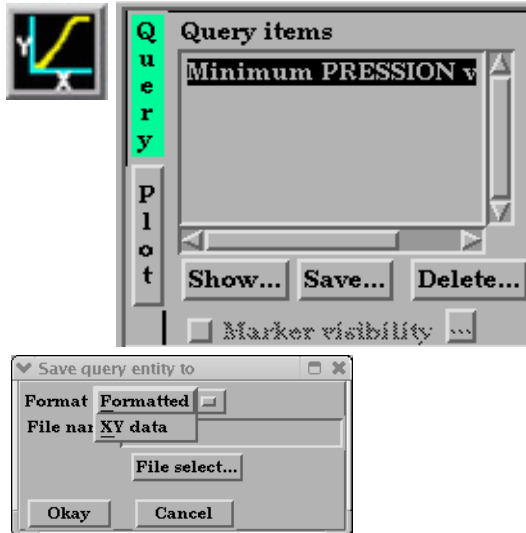

Figure 2-27

Saving or Loading XY Plot Data

Access: Desktop > Query/Plot Feature

Once the desired query item (curve) is selected in the list, the user can perform a Save operation by:

- Save...** Click this button in the Quick Interaction area of the Query/Plot feature to save the plotter curve data.
- Format** Select the Format of the data to save.
  - Formatted** is a table suitable for printing. (see [Section 2.14, Saving Query Text Information](#))
  - XY Data** is the xy file format described in [Section 11.10, XY Plot Data Format](#), which is suitable for re-loading into EnSight.
- File Name** Enter the desired filename for the xy data file, or click *File Select...* to be presented with the typical File Selection dialog from which to perform the operation.
- Loading:** To Load a previously saved or externally generated xy data file (see [Section 11.10, XY Plot Data Format](#)) into EnSight you choose the “Read From An External File” Sample type (see [How To Query/Plot](#)). You will then be presented with the typical File Selection dialog from which to select the file. **Note: A MSC/Dytran .ths file is also a valid entry for this option.**

Figure 2-28

Query/Plot Area for Read From An External File.

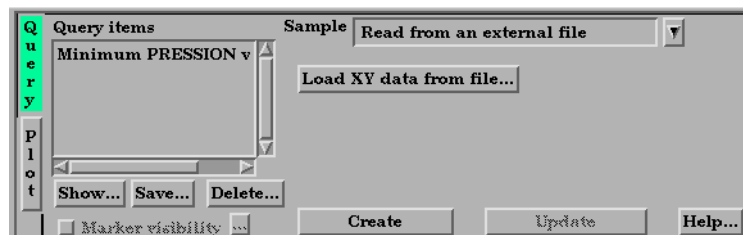

## 2.13 Saving and Restoring Animation Frames

Both Flipbook and Keyframe Animation processes have save and restore capability. These are best described in the chapters devoted specifically to these features.

For Flipbook Animations, see [Section 7.2, Flipbook Animation](#) and [How To Create a Flipbook Animation](#).

For Keyframe Animations, see [Section 7.3, Keyframe Animation](#) and [How To Create a Keyframe Animation](#).

## 2.14 Saving Query Text Information

The data used for curves in EnSight's plotter and any other information from a query or otherwise which is presented in the EnSight Message Window can be saved to a file suitable for printing.

### *From Query/Plot Save... Formatted*

One place this can occur is in the Query/Plot Quick Interaction area as described below as well as in [Section 7.5, Query/Plot](#)

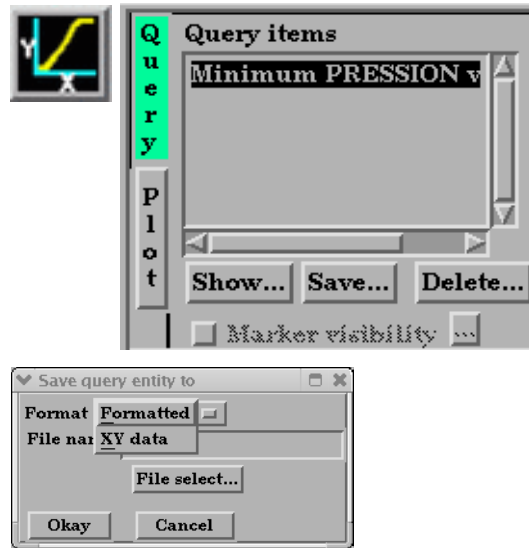

Figure 2-29  
Saving or Loading XY Plot Data

Access: Desktop > Query/Plot Feature

Once the desired query item (curve) is selected in the list, the user can perform a Save operation by:

- Save...** Click this button in the Quick Interaction area of the Query/Plot feature to save the plotter curve data.
- Format** Select the Format of the data to save.
  - Formatted** is a table suitable for printing.
  - XY Data** is the xy file format described in [Section 11.10, XY Plot Data Format](#), which is suitable for re-loading into EnSight.
- File Name** Enter the desired filename for the xy data file, or click *File Select...* to be presented with the typical File Section dialog from which to perform the operation.

### *From Query/Plot Show Text*

- Show ...** Click this button to see the plotter curve information presented in the EnSight Message Window.



### From EnSight Message Window

A file suitable for printing can be saved from any operation which places its information into the EnSight Message Window, such as Show Information queries and the Query/Plot Show Text... button described previously.

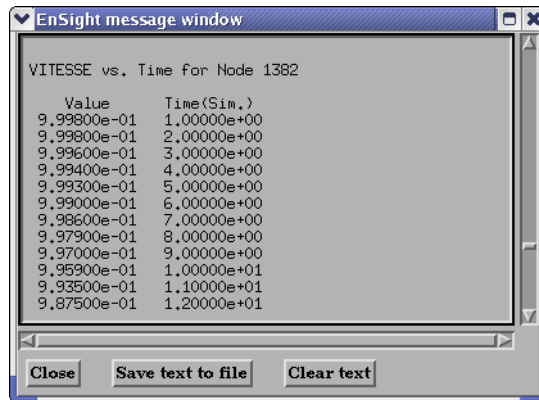

Figure 2-30  
EnSight Message Window with Save Text To File Button

#### Save Text To File

Brings up the typical File Selection dialog from which the information can be saved in the file of your choice.

## 2.15 Saving Your EnSight Environment

Every user has different postprocessing needs and personal preferences for how the EnSight windows should be positioned and sized. EnSight allows you to save dialog expandable section settings, and dialog size and position information to a file called “ensight8.winpos.default”. EnSight looks for this file at start up (in the current Client directory and if not there in the .ensight8 directory of the user’s home directory) and will bring the user interface dialogs up according to your saved settings (if the file is found).

Almost all major dialog windows are saved in the:

ensight8.winpos.default\_XRESxYRES

file (where XRES and YRES are the resolution of the monitor when the preferences were saved). The only exception are minor prompt dialogs. There are also some dialogs for which you cannot save the size (such as the Tool Positions dialog).

The ensight8.winpos.default file also contains the size and location for all of the windows containing graphics.

A number of other settings, such as mouse and keyboard buttons and Icon Bar settings can also be saved to a user preferences file.

(see Preferences... in [Section 6.2, Edit Menu Functions](#) and [How to Save GUI Settings](#))

# 3 Parts

The *Part* is the fundamental visualization entity in EnSight. Virtually every postprocessing task you perform will involve a Part, thus it is vital to understand how Parts work.

A Part is a collection of nodes and elements that are grouped together and share the same attributes. When you start EnSight, you either read directly or interactively extract Parts from the data files. Parts which come from the original dataset are referred to as model Parts. Other Parts created within EnSight, are referred to as created (or dependent) Parts.

In this chapter you will learn how to produce created Parts (parts derived from other parts) and how to modify the attributes of all Part types.

**Section 3.1, Part Overview** is *extremely important*. It defines how Parts work together to form other Parts and explains the dependencies which may exist between model Parts and created Parts. Failure to understand the concept of Parts as explained in this section will limit your ability to use EnSight. Please study this section carefully.

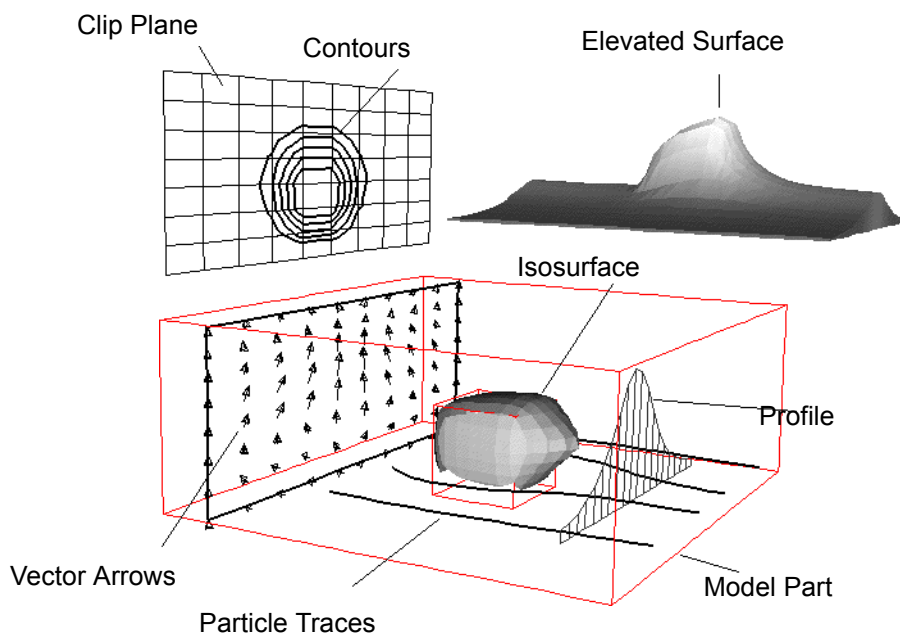

Figure 3-1  
Various EnSight Part Types

Included in this Chapter are:

[Section 3.1, Part Overview](#)

[Section 3.2, Part Selection and Identification](#)

[Section 3.3, Part Editing](#)

[Section 3.4, Part Operations](#)

## 3.1 Part Overview

In EnSight, a Part is simply a collection of nodes and elements which are grouped together, will be manipulated together, and which share the same attributes. This section defines Parts and how they are related. It gives you an overview of the Part types and Part attributes that are available within EnSight.

Parts that are defined or extracted from your dataset are referred to as *model* Parts. Parts that are created within EnSight are referred to as *created* (or *dependent*) Parts. The types of Parts that you create depends on what features within EnSight you choose to utilize. Any created Part is derived from Parts that already exist, which is why the created Parts are sometimes called dependent Parts—they depend on the Parts from which they were created. The Parts that are used to create a dependent Part are referred to as *parent* Parts. Any time that a parent Part changes, its dependent Parts must also change. A parent Part will change when you change its attributes, or modify the current time in the case of transient data.

The Main Parts List contains all Parts that have been read in from your results data or created within EnSight. Displayed is the default parts window which lists the part number and the part name.

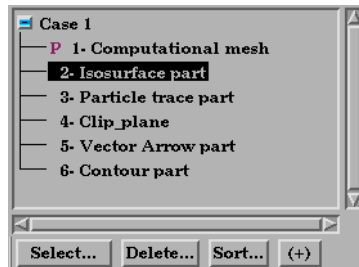

Figure 3-2  
Default Main Parts List

“+” Button

The “+” button can be used to lengthen the part window to display a larger number of parts.

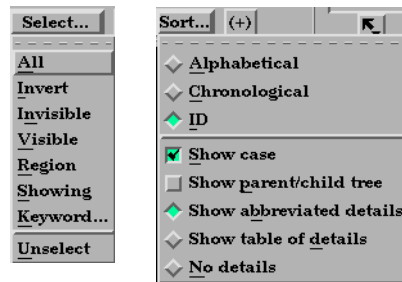

Figure 3-3  
Select and Sort Pulldown Menus

*Select Button*

The Select Button can be used to choose Parts using logical operators:

All	Select all parts
Invert	Unselect the selected and select the unselected
Invisible	Select the parts with visibility toggle off
Visible	Select the parts that have the visibility toggle on
Region	Select the Parts using the graphical selection tool (This does not work for vector arrow parts)
Showing	Select Parts that are toggled visible, that are within the graphics viewing region, and within the z-clip. Auxiliary clipping has no effect on this selection. (This does not work for vector arrow parts.)
Keyword	Select the parts using wildcards
Unselect	Unselect all parts

*Delete Button*

The Delete button can be used to delete selected parts.

*Sort Button*

The Sort Button can be used to sort and select level of detail of information about the parts.

## Sorting

Click on the Sort button and choose:

Alphabetical	To sort the list of parts alphabetically
Chronological	To sort the list of parts by their chronological creation time.
ID	To sort the list of parts by part ID (the default)

## Level of Detail

Click on the Sort button and choose:

Show case	Toggle off to remove the Case indicator or on (default) to see the Case designator. The Case of the data indicates the server on which the data resides. With Case toggled on, all parts in a given Case are indented underneath the Case number designator.
Show parent/child tree	Toggle on to show the hierarchical relationship between parent and child parts or off to show only the “P” next to the parent of the selected part. The “P” is important because modification of the Parent can affect the dependent child part.

Show abbreviated details Toggle on and the Part List will contain more information. Displayed are a Part ID Number, a Part symbol, a case number, and a Part description. The figure below of the Parts List shows a number of different Part types

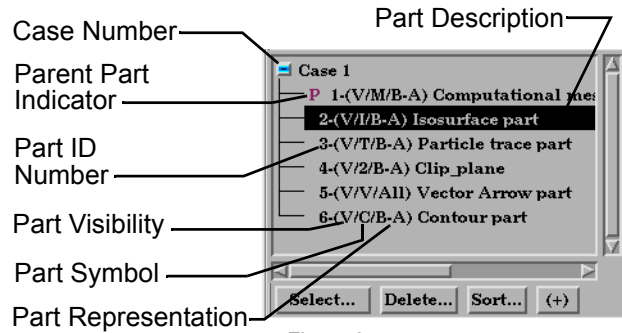

Figure 3-4  
Abbreviated Parts List

Note that in the illustration above the Isosurface Part is selected and that there is a “P” in the left column next to the Computational mesh (model) Part. This indicates that the Computational mesh Part is the parent Part of the isosurface Part. All parent Parts of a created Part will be so noted if that individual created Part is highlighted in the Main Parts List.

Every Part in the abbreviated view has a Visibility indicator, either “V” for visible or “I” for invisible.

Every Part has a representation. Shown below are the symbols used in the abbreviated view.

- B-A = 3D Border 2D Full
- F-A = 3D Feature 2D Full
- N-A = 3D Nonvisual 2D Full
- Brd = Border
- Fea = Feature Angle
- Box = Bounding Box
- All = Full
- Non = Nonvisual

Every Part has a symbol to describe it. Table 3-1 lists all of the different types of Parts and their associated symbols in the abbreviated view.

**Table 3–1 Part Types, Symbols, and Descriptions**

Part Type	Symbol	Description
Clip	(2)	A surface or line resulting from a clip of other Parts using the line, plane, or quadric tools
Contour	(C)	Lines of constant value on 2D elements
Developed Surface	(D)	A planar surface derived by unrolling a surface of revolution (i.e., the unrolling of a cylinder clip Part produced by the cylinder quadric tool)
Elevated Surface	(E)	Surface created by elevating elements by a variable

Part Type	Symbol	Description
Isosurface	(I)	Surface of constant value through 3D elements of other Parts
Material Part	(A)	A Part created according to the intersection of or domains of material values
Model Part	(M)	A Part that originated from the dataset
Particle Trace	(T)	Path of a massless Particle through a vector field
Profile	(P)	Plot of a variable along a line (Similar to a 2D elevated surface)
Separation/ Attachment Line	(L)	Line where flow separation or attachment is occurring
Shock Surface/ Region	(K)	Surface or region where shock is occurring
Subset	(S)	Valid node and/or element label range(s) from model Part(s)
Tensor Glyph	(G)	Glyph showing direction of first, second, and third eigenvectors of a tensor field.
Vector Arrow	(V)	Arrows showing direction and magnitude of vector field
Vortex Core	(X)	Line representing center of a flow vortex

Show table of details

Toggle on to show a table of part details, as shown in the composite below. While this is more self explanatory than the abbreviated mode, it also requires horizontal scrolling to see the whole table of information.

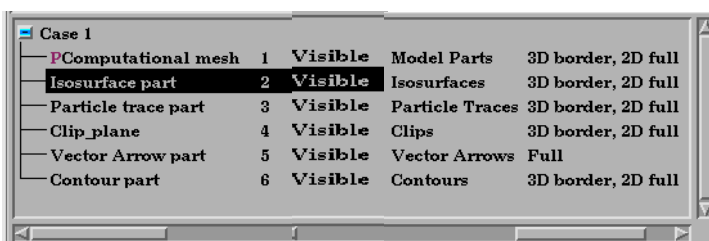

Figure 3-5  
Composite of Detailed Parts List

No details

Toggle on to omit the details, showing only the part number and the part description.

**Reassign Parent**

Parent Parts of any created Part can be changed by first selecting the created Part in the Feature Detail Editor, then selecting a new parent Part in the Main Parts List, and finally by clicking the Update Parent button in the Feature Detail Editor.

## Part Creation

Part creation occurs on either the server or the client. Since the data that is available on the client and server are different, it is useful to understand where Parts are created and where the data structures are stored. By understanding this, you will understand why some Parts can be created with certain parent Parts and others cannot. This information can be gained by examining the following table.

**Table 3–2 Part Creation and Data Location**

Part Type	Where Created	Data on Server	Data on Client
Clip	Server	Yes	Depending on Part attributes
Contour	Client	No	Yes
Developed Surface	Server	Yes	Depending on Part Attributes
Discrete Particle	Not Applicable	Yes	Depending on Part attributes
Elevated Surface	Server	Yes	Depending on Part attributes
Isosurface	Server	Yes	Depending on Part attributes
Model	Not Applicable	Yes	Depending on Part attributes
Material Part	Server	Yes	Depending on Part attributes
Particle Trace	Server	No	Yes
Profile	Client	No	Yes
Separation/ Attachment Line	Server	Yes	Depending on Part attributes
Shock Surface/ Region	Server	Yes	Depending on Part attributes
Subset	Server	Yes	Depending on Part attributes
Tensor Glyph	Client	No	Yes
Vector Arrow	Client. Server if necessary.	Maybe	Yes
Vortex Core	Server	Yes	Depending on Part attributes

(see [Introduction to Part Creation](#))

### Part Attributes

Each type of created Part has a unique set of attributes that are used to accomplish its creation, the *Creation Attributes*. Model Parts (symbol: M) and discrete Particle Parts (symbol: D) typically do not have creation attributes because they are not created—they are read or extracted from the dataset. The one exception to this is model parts originating from block structured datasets. These parts contain the I,J,K and step attributes used to create the part.

All Parts have a set of *Display Attributes* that are used in visualizing the Part in the Graphics Window. These can be modified using the Feature Detail Editor or by utilizing the Part Mode Icons (See Section 8.4). The Feature Detail Editor for each Part type will show you attributes grouped together under turndown sections. They deal with such things as color, line width, symmetry operations, etc. Display attributes do not control how the Part is created, only how it appears or how it behaves in the Graphics Window.



*Table 3–3 Display Attribute Sections*

Section:	Includes controls for...
General Attributes (see Section 3.3, Part Editing)	<p>Visibility in Graphics Window and individual Viewports</p> <p>Symmetry options</p> <p>Susceptibility to Auxiliary Clipping</p> <p>Reference frame</p> <p>Response to changes in time (frozen or active)</p> <p>Coloration (constant or by a palette associated with a variable)</p> <p>Shaded Surface and Hidden Line display</p> <p>Surface shading (flat, Gouraud, smooth)</p> <p>Opaqueness and Fill density</p> <p>Lighting (diffuse, shininess, and highlight intensity)</p>
Node, Element, and Line Attributes (see Section 3.3, Part Editing)	<p>General Visibility: Node, Line, and Element</p> <p>Label Visibility: Node and Element</p> <p>Node Representation: Node type (dot, cross, or sphere), Node Scale, Node Detail (for spheres), and Node size (constant or variable)</p> <p>Line Representation: Line Width and Line style (solid, dotted, or dot-dash)</p> <p>Element representation on client (full, border, 3D border/2D full, feature angle, or non visual), Element-size, Shrink-Factor, Element Angle and Polygon Reduction factor</p>
Displacement Attributes (see Section 3.3, Part Editing)	<p>Displacement variable</p> <p>Displacement scaling factor</p>

## 3.2 Part Selection and Identification

In the process of creating a Part you will need to be able to select the parent Part(s) from the Main Parts List. You will also find that it is possible to either read or create so many Parts within EnSight that you become confused as to the identity of each Part. This section describes Part selection and identification

### Selecting Parts using the mouse

Items in all Parts Lists are selected using standard Motif/Win32 methods:

To:	Do This:	Details
Select an item	Select (or single-click)	Place the mouse pointer over the item and click the left mouse button. The item is highlighted to reflect the “selected” state.
Extend a contiguous selection	Select-drag	Place the mouse pointer over the first item. Click and hold the left mouse button as you drag over the remaining items to be selected. Only contiguous items may be selected in this fashion.
Extend a (possibly long) contiguous selection	Shift-click	Select the first item. Place the mouse pointer over the last item in the list to be selected. Press the shift key and click the left mouse button. This action will extend a selection to include all those items sequentially listed between the first selection and this one.
Extend a non-contiguous selection	Control-click	Place the mouse pointer over the item. Press the control key and click the left mouse button. This action will extend a selection by adding the new item, but not those in-between any previously selected items.
De-select an item	Control-click	Place the mouse pointer over the selected item. Press the control key and click the left mouse button. This action will de-select the item.
Open the Quick Interaction Area for a Part	Double-click	Place the mouse pointer over the item and click the left mouse button twice in rapid succession.

## Selecting Parts using the Select Button

Underneath the Parts list is the Select Button which can be used to select Parts using logical operators.

All	Select all parts
Invert	Unselect the selected and select the unselected
Invisible	Select the parts with visibility toggle off
Visible	Select the parts that have the visibility toggle on
Region	Select the Parts using the graphical selection tool (This does not work for vector arrow parts)
Showing	Select Parts that are toggled visible, that are within the graphics viewing region, and within the z-clip. Auxiliary clipping has no effect on this selection. (This does not work for vector arrow parts.)
Keyword	Select the parts using wildcards
Unselect	Unselect all parts

(see [How To Select Parts](#))

## Identifying Parts

There are two quick ways to identify one or more Parts that have been selected in the Main Parts List. You can identify them in the Graphics Window by toggling visibility on/off while in Part Mode or you can select View > Show Selected Parts... from the Main Menu to show only the selected Part(s) in the pop-up Selected Part(s) Window.

### 3.3 Part Editing

In EnSight, new Parts can be created and edited in the Quick Interaction Area Editor or in the Feature Detail Editor specific to each type of Part. This process is described in Sections 7.2 to 7.9. For editing, the Quick Interaction Area provides access to the most common attributes; the Feature Detail Editor allows modification of all attributes.

Whereas each individual change made in the Quick interaction Area Editor is applied to the Part immediately, the Feature Detail Editor allows you to make a number of changes to various attributes and then apply them all at one time. This is done by toggling off View > Immediate Modification in the Feature Detail Editor. The default behavior is to immediately apply a change when you press Return.

The Feature Detail Editor for Parts is opened from the Main Menu (or by double clicking on a Part creation Icon in the Main GUI Feature Icon Bar).

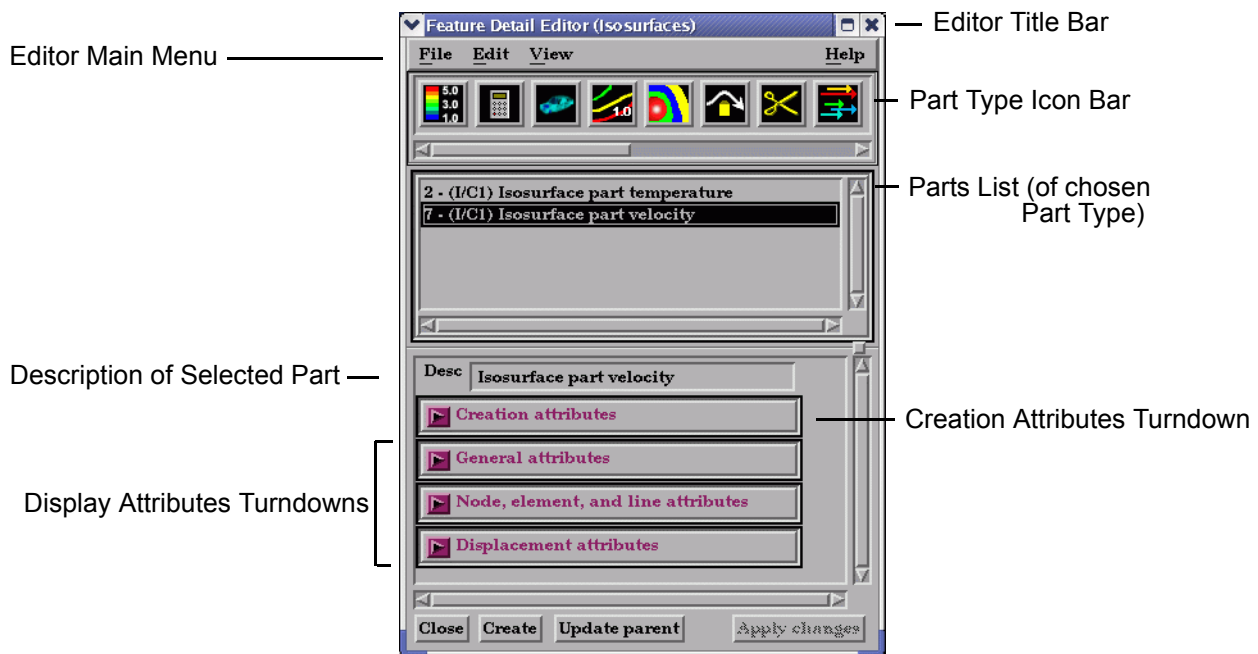
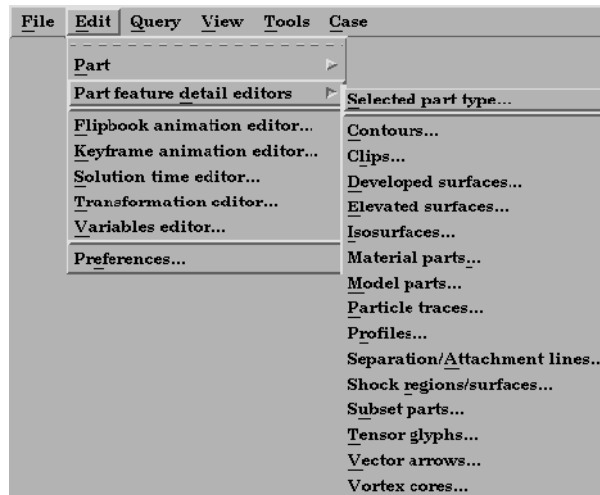

Figure 3-6  
Feature Detail Editor (Isosurfaces)

## Feature Detail Editor Main Menu

*File* Not applicable when Feature Detail Editor is used for Parts - only applicable for Variables.

*Edit* Opens a pull down menu.

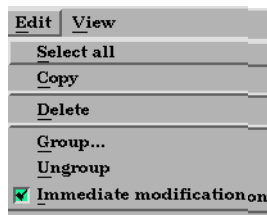

Figure 3-7  
Feature Detail Editor Edit pull-down menu

Select All Selects all Parts in Feature Detail Editor Parts List. (see [Section 3.4, Part Operations](#))

Copy Makes a copy of all selected Parts. (see [Section 3.4, Part Operations](#)), also (see [How To Copy a Part](#))

Delete Deletes selected Parts. (see [Section 3.4, Part Operations](#)), also (see [How To Delete a Part](#))

Group... Groups the selected parts into a new part and removes the original parts from the list.

Ungroup Extracts the original parts out of a group and removes the group part.

Immediate Modification Toggle Toggles on/off the immediate modification of Parts when individual changes are made to Attributes within the Feature Detail Editor. Default is on. By toggling off, you can make several changes within the Feature Detail Editor and then apply them all at one time by clicking the Apply Changes button.

*View* Opens a pull-down menu.



Figure 3-8  
Feature Detail Editor View pull-down menu

Show Selected Part(s) Toggle Opens the Selected Part(s) Window in which only Parts selected in the Feature Detail Editor's Parts List are visible.

### Part Type Icon Bar

The Feature Detail Editor is initially opened from EnSight's Main Menu (or by double clicking a Part creation icon in the Feature Icon Bar) and the Feature Detail Editor's Parts List contains all Parts of the type named in the Editor's Title Bar. The type of Parts in the Feature Detail Editor's Parts List may be changed by clicking on the appropriate icon in the Feature Detail Editor's Part Type Icon Bar. The figure below describes the four types of choices available.

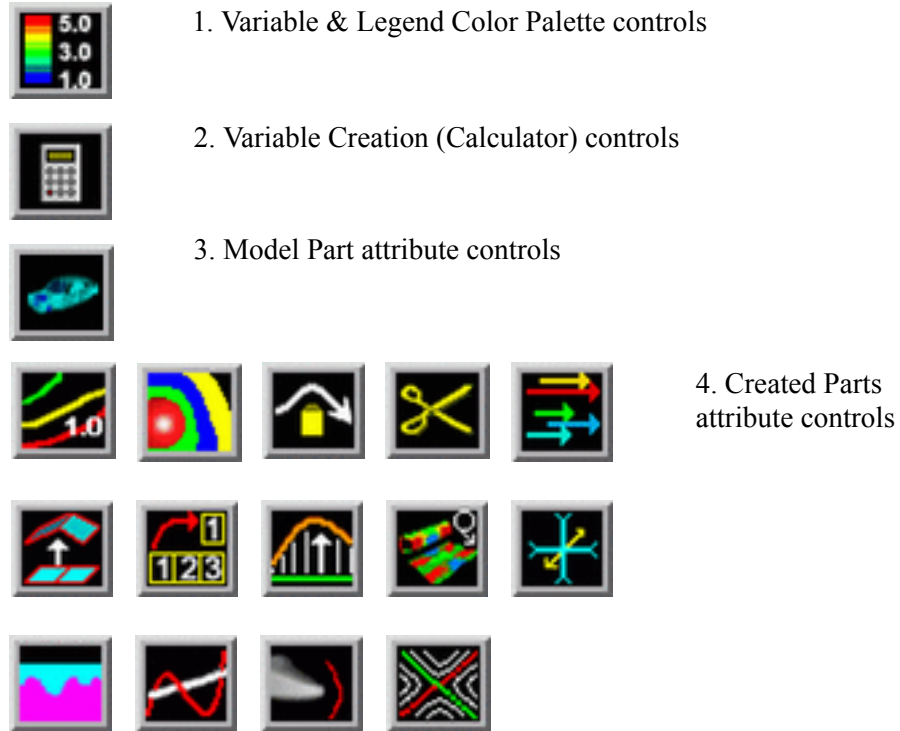

Figure 3-9  
Feature Detail Editor Part Type Selection Icons

#### *Variable & Legend Color Palette Icon*



Click this icon to edit color controls. See Section 4.1 Variable Selection and Activation for further discussion.

#### *Variable Creation (Calculator) Icon*



Click this icon to use the calculator to create new variables for the parts selected in the Main Parts window.

## Creation Attributes

Creation Attributes are “specific” attributes used to create (or modify) model and created Parts.

### Model Parts



Creation Attributes for updating the I,J,K node range attributes of the selected block structured Model Parts with proper updating of all dependent parts and variables. The Creation Attributes area is active only for structured Model Parts.

Access: Main Menu > Edit > Part Feature Detail Editors > Model Parts...

Creation attributes					
Using node ranges:					
	From	To	Step	Min	Max
I	<input type="text"/>	<input type="text"/>	<input type="text"/>	<input type="text"/>	<input type="text"/>
J	<input type="text"/>	<input type="text"/>	<input type="text"/>	<input type="text"/>	<input type="text"/>
K	<input type="text"/>	<input type="text"/>	<input type="text"/>	<input type="text"/>	<input type="text"/>

Figure 3-10  
Feature Detail Editor (Model) Creation Attributes Area

### Using Node Ranges

*IJK From* These fields specify the desired minimum interval value in the respective IJK component direction of the Model Part.

*IJK To* These fields specify the desired maximum interval value in the respective IJK component direction of the Model Part.

*IJK Step* These fields specify the desired interval stride value in the respective IJK component direction of the Model part.

*IJK Min* These fields verify the minimum interval limit in the respective IJK component direction of the Model part.

*IJK Max* These fields verify the maximum interval limit in the respective IJK component direction of the Model part.

(see [How To Create IJK Clips](#))

Created Parts

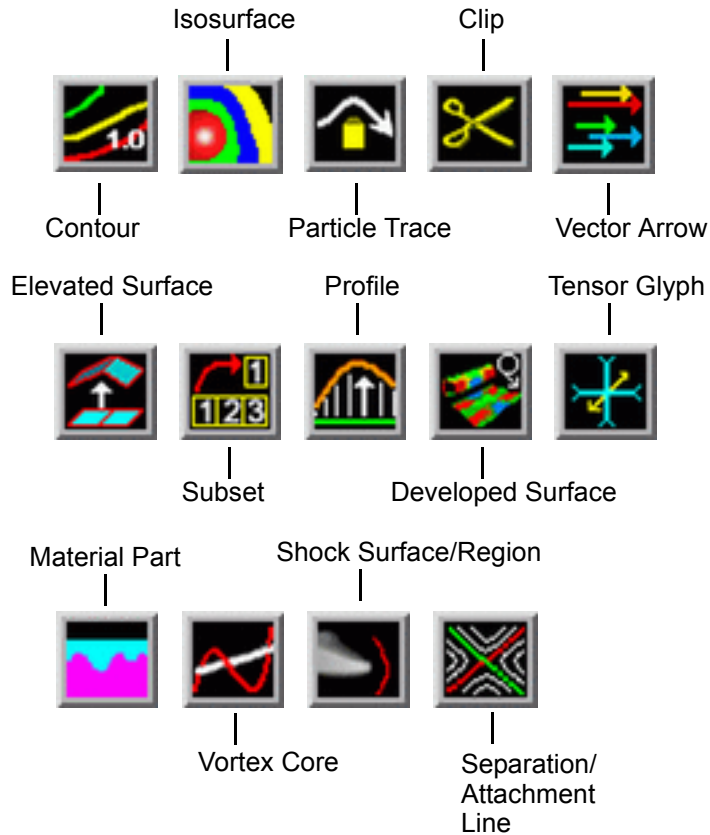

See the appropriate Section in Chapter 7 for a description of the Creation Attributes section.

- (see Section 7.7, Contour Create/Update)
- (see Section 7.8, Isosurface Create/Update)
- (see Section 7.9, Clip Create/Update)
- (see Section 7.10, Vector Arrow Create/Update)
- (see Section 7.11, Particle Trace Create/Update)
- (see Section 7.12, Subset Parts Create/Update)
- (see Section 7.13, Profile Create/Update)
- (see Section 7.14, Elevated Surface Create/Update)
- (see Section 7.15, Vortex Core Create/Update)
- (see Section 7.16, Shock Surface/Region Create/Update)
- (see Section 7.17, Separation/Attachment Lines Create/Update)
- (see Section 7.20, Developed Surface Create/Update)
- (see Section 7.21, Tensor Glyph Parts Create/Update)



## General Attributes

General Attributes are “general” in that: (a) all Parts have them, and (b) they can’t be neatly categorized into any other attribute type. Like all Part attributes, they are set individually for each Part.

Access: Main Menu > Edit > Part Feature Detail Editors > (Isosurfaces..., etc.) > General Attributes

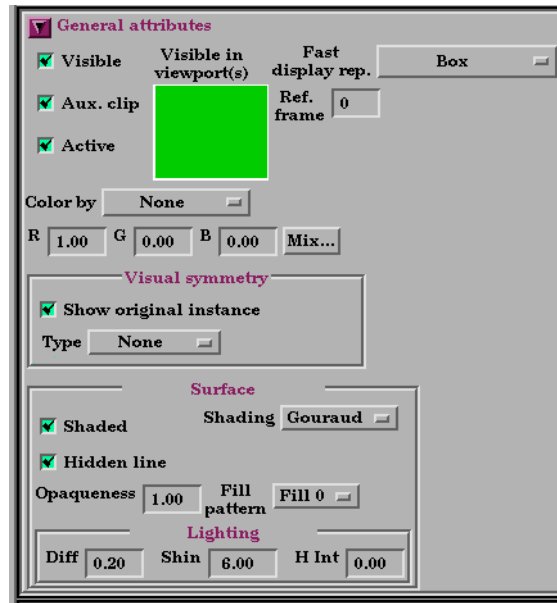

Figure 3-11  
Feature Detail Editor General  
Attributes Area

### *Visible Toggle*

Toggles-on/off whether Part is visible on a global basis (in the Graphics Window or in all viewports). (Performs the same function as the Visibility Toggle in the Parts Mode Icon Bar). Default is ON.

### *Visible In Viewports*

This small window allows you to control the visibility of the selected Part(s) on a per Viewport basis. Each visible viewport is shown. A green Viewport indicates that the selected Part(s) will be visible in this Viewport, while a black Viewport indicates that the selected Part(s) will not be visible. Change the visibility (black to green, green to black) by selecting a viewport with the mouse.

### *Fast Display Rep.*

This button opens a pop-up menu button for the selection of the fast display representation used to display a part on the client. This attribute helps the display of complex data sets. The part’s fast display representation displays according to whether the Fast Display Mode (located in the View Menu or on the desktop) is on or off and on the state of the Static Fast Display button located under Edit > Preferences..., Performance. For instance, when the Fast Display Mode is Off (default) the part displays according to its specified Element Representation. When on, the parts are displayed by the fast display representation. The fast display representation will only be used while performing transformations, unless the Static Fast Display option has been selected. The part detail representations are:

<i>Box</i>	a bounding (Cartesian extent) box of all part elements (default).
<i>Off</i>	display according to specified Element Representation.
<i>Points</i>	point cloud representation of the part.
<i>Reduced poly</i>	polygon reduced representation of the part.
<i>Sparse Model</i>	display a percentage of the model in each display box (immediate mode only). You control this percentage in the performance preferences. <i>Note, that it is useful for large models, but should probably not be used for small models.</i>

(see [How To Set Global Viewing](#))

### *Visual Symmetry*

This section contains controls which allow you to produce either rotational or mirror

visually symmetric images of parts. In general, symmetry enables you to reduce the size of your analysis problem while still visualizing the “whole thing.” Symmetry affects only the displayed image, not the data, so you cannot query the image or use the image as a parent Part. However, you can create the same effect by creating dependent Parts with the same symmetry attributes as the parent Part.

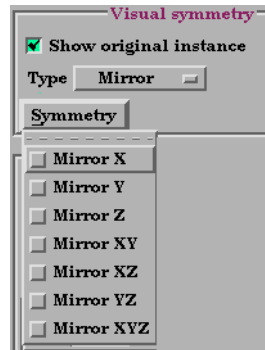

Figure 3-12  
Mirror Visual Symmetry

Mirror visual symmetry includes the ability to toggle-on/off the display of a mirror image of Parts (which are selected in the Feature Detail Editor’s Parts List) in each of the seven other quadrants of the Part’s local frame. It also allows you to turn on or off the original (non-symmetric) part representation. It performs the same function as the Visual Symmetry Pull-down Icon in the Part Mode Icon Bar. You can mirror the Part to more than one quadrant. If the Part occupies more than one quadrant, each portion of the Part mirrors independently. Symmetry works as if the local frame is Rectangular, even if it is cylindrical or spherical. The images are displayed with the same attributes as the Part. For each toggle, the Part is displayed as follows. The default for all toggle buttons is OFF, except for the original representation - which is ON.

- Mirror X            quadrant on the other side of the YZ plane.
- Mirror Y            quadrant on the other side of the XZ plane.
- Mirror Z            quadrant on the other side of the XY plane.
- Mirror XY          diagonally opposite quadrant on the same side of the XY plane.
- Mirror XZ          diagonally opposite quadrant on the same side of the XZ plane.
- Mirror YZ          diagonally opposite quadrant on the same side of the YZ plane.
- Mirror XYZ         quadrant diagonally opposite through the origin.
- Show Original Instance    the original part location.

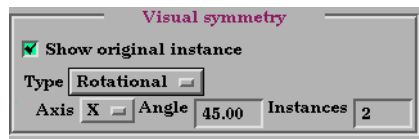

Figure 3-13  
Rotational Visual Symmetry

Rotational visual symmetry allows for the display of a complete (or portion of a) “pie” from one “slice” or instance. You control this option with:

- Axis X            rotates about the X axis
- Y            rotates about the Y axis
- Z            rotates about the Z axis
- Angle            specifies the angle (in degrees) to rotate each instance from the previous
- Instances        specifies the number of rotational instances.
- Show Original Instance    show the original instance or not

(see [How To Set Symmetry](#))

*Aux Clip Toggle*

Toggles-on/off whether Part(s) selected in the Part List of the Feature Detail Editor will be affected by the Auxiliary Clipping Plane feature, which enables you to make invisible that portion of each Part on the negative side of the current position of the Plane

Tool. Performs the same function as the Part Mode: Auxiliary Clipping Toggle Icon. A Part with its Aux Clip attribute toggled-off will not be cut away. Default is ON. (see Auxiliary Clipping in [Section 6.4, View Menu Functions](#)).

<i>Active Toggle</i>	Toggles-on/off whether or not display of the Part automatically updates as the solution time changes. When visualizing transient data, you may wish to “freeze” a Part in time while other Parts continue to update. For example, you can create two identical vector-arrow Parts, toggle-off Active for one of them, change the time step of the display, and see how the vector arrows change from one time step to the other. Only the EnSight client Part is frozen, the EnSight server Part is kept current. Default is ON.
<i>Ref. Frame</i>	This field specifies which frame the Part is assigned to. Default is the frame of the Part’s parent Part (Frame 0 for original model Parts). Enter a different frame number in the field to change the assignment. Changing a Part’s frame causes the Part to be drawn in the new coordinate frame. Once assigned to a different frame, the Part will transform with that frame. The choice of frame does not affect variable values. The interpolated value of a variable at point 0,0,0 in Frame 0 is the same as at point 0,0,0 in Frame 1, even though the points may appear at different locations in the Main View Window. (see <a href="#">Section 8.5, Frame Mode</a> )
<i>Color By</i>	This button opens a pop-up menu for the selection of the variable color palette by which you wish to color the selected Part(s). Coloring a Part with a palette does not normally affect graphics performance while in line drawing mode, but Shaded Surface mode performance can become considerably slower. If you do not color by a palette (Color By > None), the Part will be displayed according to the color specified in the R, G, B fields. If you want to color Parts by palettes and want Shaded Surface mode, consider using the Static Lighting option (see Static Lighting in <a href="#">Section 6.4, View Menu Functions</a> ).
<i>R G B</i>	These fields allow you to specify a solid color for the selected Part(s) (applicable only if Color By is None). Enter a numerical value from 0 to 1 for each component color (Red, Green, and Blue).
<i>Mix...</i>	Opens the Color Selector dialog for the selection of a solid color for the selected Part(s) (applicable only if Color By is None). (see <a href="#">Section 8.1, Color Selector</a> )
<i>Surface</i>	
Shaded Surface Toggle	Toggles on/off surface shading for individual Parts. When global Shaded Surface has been toggled on for the Graphics Window display (from Main Menu > View > Shaded Surface or via the Global Shaded Surface Toggle in the View Mode Icon Bar), individual Parts can be forced to stay in line drawing mode using this toggle. Default is ON. (see <a href="#">Section 6.4, View Menu Functions</a> )
Hidden Line Toggle	Toggles on/off hidden line representation for individual Parts. When global <i>Hidden Line</i> has been toggled on for the Graphics Window display (from Main Menu > View > Hidden Line or via the Global Hidden Line Toggle in the View Mode Icon Bar), individual Parts can be forced not to appear as Hidden Line representation using this toggle. (To have lines hidden behind surfaces, Parts must have surfaces, i.e. 2D elements) Default is ON. (see <a href="#">Section 6.4, View Menu Functions</a> )
Shading	Opens a pop-up menu for selection of appearance of Part surface when Shaded Surface is on. Normally the mode is set to Gouraud, meaning that the color and shading will interpolate across the polygon in a linear scheme. You can also set the shading type to Flat, meaning that each polygon will get one color and shade, or Smooth which means that the

surface normals will be averaged to the neighboring elements producing a “smooth” surface appearance. Not valid for all Part types. Options are:

*Flat*        Color and shading same for entire element  
*Gouraud*    Color and shading varies linearly across element  
*Smooth*     Normals averaged with neighboring elements to simulate smooth surfaces

**Opaqueness**        This field specifies the opaqueness of the selected Part(s). A value of 1.0 indicates that the Part is fully opaque, while a value of 0.0 indicates that it is fully transparent. Setting this attribute to a value other than 1.0 can seriously affect the graphics performance.

**Fill Pattern**        Opens a pop-up menu for selection of a fill pattern which can provide pseudo-transparency for shaded surfaces. Default is Fill 0 which uses no pattern (produces a solid surface), while Fill patterns 1 through 3 produce a EnSight defined fill pattern.

#### *Lighting*

**Diff**                This field specifies diffusion (minimum brightness or amount of light that a Part reflects). (Some applications refer to this as *ambient* light.) The Part will reflect no light if value is 0.0. If value is 1.0, no lighting effects will be imposed and the Part will reflect all light and be shown at full color intensity at every point. To change, enter a value from 0 to 1.

**Shin**                This field specifies shininess. You can think of the shininess factor in terms of how smooth the surface is. The larger the shininess factor, the smoother the object. A value of 0 corresponds to a dull finish and a value of 100 corresponds to a highly shiny finish. To change, enter a value from 0 to 100.

**H Int**                This field specifies highlight intensity (the amount of white light contained in the color of the Part which is reflected back to the observer). Highlighting gives the Part a more realistic appearance and reveals the shine of the surface. To change, enter a value from 0 to 1 with larger values representing more white light. Will have no effect if Shin parameter is zero.  
 (see [How To Set Attributes](#))

### *Troubleshooting Surface Attributes and Lighting*

Problem	Probable Causes	Solutions
Part not in Shaded Surface mode	Global Toggle not on, or if on, Shaded Surface is turned off for the Part in the Feature Detail Editor	Turn on Shaded Surface toggle from View menu of Main Menu or turn and make sure Shaded Surface is turned on for the Part in the Feature Detail Editor.
	Part contains only 1D elements	No Solution
Part appears not to have any lighting.	Diffuse light intensity too high	Lower the Diff value.

## Node, Element, and Line Attributes

Each Part's Node, Element, and Line attributes control the representation of the Part on the client, and how nodes, elements, and lines are displayed.

Access: Main Menu > Edit > Part Feature Detail Editors > Node, Element, and Line Attributes

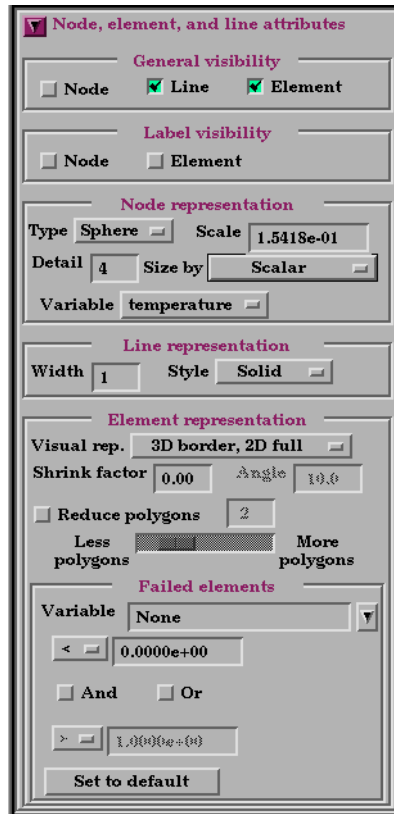

Figure 3-14  
Feature Detail Editor Node, Element, and Line Attributes Area

### General Visibility

- |                |  |
|----------------|--|
| Node Toggle    | Toggles-on/off display of Part's nodes whenever the Part is visible. Default is OFF.   |
| Line Toggle    | Toggles-on/off display of line (1D) elements in the client-representation whenever the Part is visible. Default is ON.   |
| Element Toggle | Toggles-on/off display of 2D elements in the client-representation whenever the Part is visible. Note that 3D elements are always represented as 2D elements on the client. Default is ON. |

### Label Visibility

- |                |  |
|----------------|--|
| Node Toggle    | Toggles-on/off display of Part's node labels (if they exist) whenever the Part is visible. Only model Parts may have node labels. Default is OFF.  |
| Element Toggle | Toggles-on/off display of Part's element labels (if they exist) whenever the Part is displayed in Full visual representation. Only model Parts may have element labels, and. Default is OFF. |

### Node Representation

- |      |   |
|------|---|
| Type | Opens a pop-up menu for the selection of symbol to use when displaying the Part's nodes. Default is Dot. Options are:<br><i>Dot</i> to display nodes as one-pixel dots.<br><i>Cross</i> to display nodes as three-dimensional crosses whose size you specify.<br><i>Sphere</i> to display the nodes as spheres whose size and detail you specify. |
|------|---|

### 3.3 Variable Creation (Calculator) Icon

Scale	This field is used to specify scaling factor for size of node symbol. Values between 0 and 1 reduce the size, factors greater than one enlarge the size. Not applicable when node-symbol Type is Dot. Default is 1.0.
Detail	This field is used to specify how round to draw the spheres when the node-symbol type is Sphere. Ranges from 2 to 10, with 10 being the most detailed (e.g., roundest spheres). Higher values take longer to draw, slowing performance. Default is 2.
Size By	Opens a pop-up menu for the selection of variable-type to use to size each node-symbol. For options other than Constant, the node-symbol size will vary depending on the value of the selected variable at the node. Not applicable when node-symbol Type is Dot. Default is Constant. Options are: <i>Constant</i> sizes node using the Scale factor value. <i>Scalar</i> sizes node using a scalar variable. <i>Vector Mag</i> sizes node using magnitude of a vector variable. <i>Vector X-Comp</i> sizes node using magnitude of X-component of a vector variable. <i>Vector Y-Comp</i> sizes node using magnitude of Y-component of a vector variable. <i>Vector Z-Comp</i> sizes node using magnitude of Z-component of a vector variable.
Variable	Selection of variable to use to size the nodes. Activated variables of the appropriate Size By type are listed. Not applicable when node-symbol Type is Dot or Size By is Constant.

#### Line Representation

Width	Specification of width (in pixels) of line elements and edges of 2D elements whenever they are visible. Range is from 1 to 20. Default is 1. Line widths other than 1 are not available on all hardware. This performs the same function as the Part Line Width Pulldown Icon in Part Mode.
Style	Selection of style of line when lines are visible. Default is Solid. Options are: <i>Solid</i> <i>Dotted</i> <i>Dot-Dash</i>

#### Element Representation

Visual Rep.	Selection of representation of Part's elements on the client. Saves memory and time to download. <i>3D border</i> ; <i>2D full</i> represents the Part's 3D elements in Border representation, the Part's 1 and 2D elements in Full representation. The result is the outside surfaces of the Part are displayed along with all bar elements. <i>Border</i> represents the Part's 3D elements with 2D elements corresponding to unshared element faces, the Part's 2D elements with 1D elements corresponding to the unshared edges, and the Part's 1D elements as 1D elements. The result is the outside faces and edges of the Part's elements. <i>Feature Angle</i> first runs the 3D border, 2D full representation to get a list of 1 and 2D elements. The 1D elements and all non-shared 2D edges will be shown, but only the shared edges above the Angle value will be shown. The result consists of 1D elements visualizing the sharp edges of the Part. <i>Bounding Box</i> represents all Part elements as a bounding box surrounding the Cartesian extent of the elements of the Part. <i>Full</i> represents all faces of the Part's 3D elements, and all the 1 and 2D elements. <i>Non Visual</i> means the Part exists on the server, but is not loaded on the client. Not Loaded Parts may be used as parent Parts, but do not exist on the client.
Shrink Factor	Specification of scaling factor by which to shrink every element toward its centroid. Enter the fraction to shrink by in range from 0 to 1. Default is 0.0 for no shrinkage.

Angle	Specification of lower limit for not displaying shared edges in Feature Angle Representation. Value is in degrees.
Reduce Polygons	Lower the polygon density used to represent the part. Useful for very large models. Toggle on, then type in a value to reduce by, or slide the slider.
<b>Failed Elements</b>	
Variable	Elements are removed from display on the client and from calculation on the server using the named variable and the threshold operator(s) (<, >, =, !=) and their relationship (logical 'and' or logical 'or'). Applies only to model parts.
<, >, =, !=	Elements are removed from display on the client and from calculation on the server using the above named variable and the threshold operator(s) (<, >, =, !=) and their relationship (logical 'and' or logical 'or'). (see <a href="#">How To Set Attributes</a> and <a href="#">How To Display Labels</a> )

### Troubleshooting Node, Element and Line Attributes

Problem	Probable Causes	Solutions
After changing to Feature Angle representation, the Part is not shown.	Angle value is to large	Set Angle to smaller value.

### Displacement Attributes

Displacement Attributes specify how to displace the Part nodes based on a vector variable. Each node of the Part is displaced by a distance and direction corresponding to the value of a vector variable at the node. The new coordinate is equal to the old coordinate plus the vector times the specified Factor, or:

$$C_{\text{new}} = C_{\text{orig}} + \text{Factor} * \text{Vector},$$

where  $C_{\text{new}}$  is the new coordinate location,  $C_{\text{orig}}$  is the coordinate location as defined in the data files, Factor is a scale factor, and Vector is the displacement vector.

You can greatly exaggerate the displacement vector by specifying a large Factor value. Though you can use any vector variable for displacements, it certainly makes the most sense to use a variable calculated for this purpose. Note that the variable value represents the *displacement* from the original location, not the *coordinates* of the new location.

Access: Main Menu > Edit > Part Feature Detail Editors > Displacement Attributes



Figure 3-15  
Feature Detail Editor Displacement Attributes Area

<b>Displace by</b>	Opens a pop-up menu for selection of vector variable to use for displacement (or None for no displacement). Variable must be a vector and be activated.
<b>Factor</b>	This field is used to specify a scale factor for the displacement vector. New coordinates are calculated as: $C_{\text{new}} = C_{\text{orig}} + \text{Factor} * \text{Vector}$ , where $C_{\text{new}}$ is the new coordinate location, $C_{\text{orig}}$ is the original coordinate location as defined in the data file, Factor is a scale factor, and Vector is the displacement vector. Note that a value of 1.0 will give you “true” displacements. (see <a href="#">How To Display Displacements</a> )

### Troubleshooting Displacement Attributes

Problem	Probable Causes	Solutions
Displacement not visible	Displace By attribute set to None for Part that is not displacing. Factor value too small.	Set the Displace By attribute Specify a larger Factor.
<i>Create</i>	Clicking this button creates a new Part using attributes currently selected/specified in the Feature Detail Editor. This performs the same function as the Create button in the Quick Interaction Area Editor for each type of created Part. Clicking Create updates the Graphics Window and adds the new Part to the Main Parts List and to the Parts List in the Feature Detail Editor for this type of Part. Not applicable for model Parts or discrete Particles. (see <a href="#">Introduction to Part Creation</a> )	
<i>Update Parent</i>	Clicking this button assigns the Part which is currently selected in the Main Parts List as the new parent Part of the created Part(s) which is(are) currently selected in the Feature Detail Editor's Parts List.	
<i>Apply Changes</i>	Clicking this button applies all changes that have been made within the Feature Detail Editor all at once if Immediate Modification has been toggled off above in the Feature Detail Editor's Edit pull-down menu. If Creation attributes have been changed, the Part will be regenerated.	

### IJK Axis Display Attributes

All Model and clip parts will have these attributes shown, but they only apply to those model and clip parts which are structured.

Access: Main Menu > Edit > Part Feature Detail Editors > IJK Axis Display Attributes



Figure 3-16  
Feature Detail Editor IJK Axis Display Attributes Area

<i>IJK Axis Visible</i>	Toggle on to display an IJK axis triad for the part. IJK axis triad only visible when part is visible.
<i>Scale</i>	The scale factor for the IJK Axis triad. (see <a href="#">How To Set Attributes</a> )

### Troubleshooting IJK Axis Display Attributes

Problem	Probable Causes	Solutions
IJK Axis not visible	IJK Axis Display toggle not on for part of interest. Scale value too small. Part is not a structured part. Part is not visible	Toggle it on. Specify a larger scale. No IJK axis possible for this part. Toggle on part visibility



## 3.4 Part Operations

This section will describe the Part operations accessible through “Edit > Part” in the Main Menu and “Edit” in the Feature Detail Editor Menu. These include *Select All*, *Select*, *Delete*, *Assign to Single or Multiple Viewports*, *Group*, *Ungroup*, *Copy*, *Cut*, *Extract*, and *Merge*.

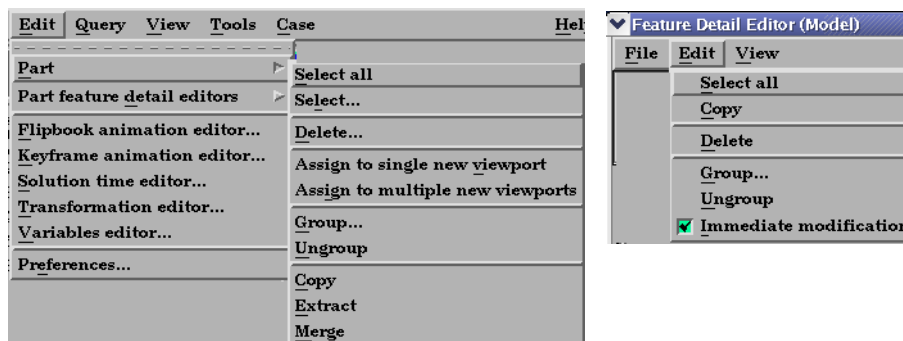

Figure 3-17  
Part Operation Selection Menus

### Select All

Choosing this from the Main Menu > Edit > Part pull-down, selects all Parts in the Main Parts List. Choosing this from the Edit pull-down in the Feature Detail Editor Menu selects all Parts in the Feature Detail Editor Parts List.

Access: Main Menu > Edit > Part > Select All  
Feature Detail Editor Menu > Edit > Select All

(see [How to Select Parts](#))

### Select ...

Choosing this from the Main Menu > Edit > Part pull-down, opens the Select Part(s) By Keyword dialog.

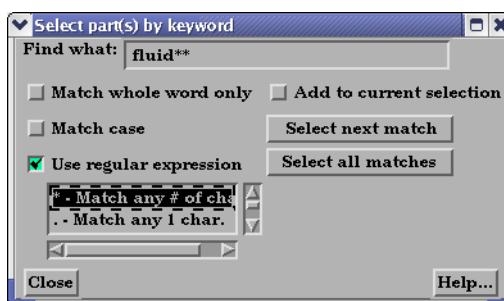

Figure 3-18  
Select Part(s) By Keyword dialog

### Find What

This field is used to specify the keyword or regular expression to compare (match) against Part names.

### Match Whole Word Only Toggle

When on, the entire Part name must match the keyword or regular expression. When off, a Part name will be selected if only a substring of the Part name matches.

### Match Case Toggle

When on, the comparison is case sensitive. When off, case is ignored.

### Use Regular Expression Toggle

When on, special characters in the keyword will be used to define a regular expression. When off, any special characters will be treated as a regular character during comparison.

### 3.4 Part Operations

Special Character Selection List	<p>Contains a list of special characters available to create a regular expression. Selecting an item from the list will insert the special character into the “Find What” text field at the cursor location.</p> <ul style="list-style-type: none"><li>* Match any number of characters in the part name</li><li>. Match any one character in the part name</li><li>~ Match part names that do not match the specified search criteria.</li><li>  Separates multiple search keywords or regular expressions. (extra spaces are not allowed around “[”)</li></ul> <p>Examples: Find What: abc*xyz Match Whole Word Only: On <i>Select any Part who’s name starts with “abc” and ends with “xyz”</i></p> <p>Find What: tom jerry Match Whole Word Only: OFF <i>Select all Part s who’s names contain the string “tom” and/or the string “jerry”</i></p>
Add to Current Selection Toggle	When on, any matching Part names will be added to the list of Part names currently selected. When off, only the matching Part names will be selected.
Select Next Match	Selects the next Part name which matches the keyword or regular expression.
Select All Matches	Selects all Part names which match the keyword or regular expression.
Delete...	<p>If chosen from the Main Menu &gt; Edit &gt; Part pull-down, deletes all selected Parts in the Main Parts List after you have confirmed in a pop-up dialog that you wish to do so. If chosen from the Edit pull-down in the Feature Detail Editor Menu, deletes all selected Parts in the Feature Detail Editor Parts List after you have confirmed in a pop-up dialog that you wish to do so. If model Parts are deleted, they are no longer available for the current session. Parts dependent upon selected Parts will also be deleted or modified</p> <p>Access: Main Menu &gt; Edit &gt; Part &gt; Delete... Feature Detail Editor Menu &gt; Edit &gt; Delete...</p> <p>(see <a href="#">How to Delete a Part</a>)</p>
Assign to Single New Viewport	Creates a new viewport and assigns all of the selected parts to the new viewport. The new viewport will be 2D if all of the selected parts are 2D and lie on the same plane.
Assign to Multiple New Viewports	Creates a new viewport for each of the selected parts. Each new viewport will show one part only. If the part is 2D, the viewport will be 2D. Further, if the part assigned to the new viewport is a XYZ or IJK clip or an isosurface, annotation will be created in the lower left corner of the viewport indicating the value of the clip or iso.
Group/Ungroup	<p>The group operation is used to collect any number of parts into a set which can be modified and utilized as one entity. The operation is non-destructive and reversible, and is used solely as a convenience to the user in order to organize a large number of parts.</p> <p>Any attribute modification to a grouped part affects each of the parts in the group. Similarly, if a grouped part is used as a parent part, each part in the group is used as a parent in the creation process.</p> <p>When group is selected, the dialog shown in the figure below will appear. A part name must be input in order to complete the grouping operation.</p>

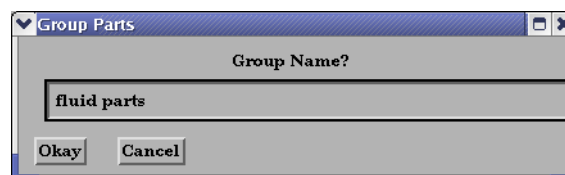

Figure 3-19  
Group Parts Dialog

Only parts of the same type and case can be grouped together. Further, groups can not contain other part groups.

(see [How To Group Parts](#))

### Copy

If chosen from the Main Menu > Edit > Part pull-down, makes a copy of selected Part(s) in the Main Parts List. If chosen from the Edit pull-down in the Feature Detail Editor Menu, makes a copy of selected Part(s) in the Feature Detail Editor Parts List.

The Copy operation creates a dependent copy of another (original) Part. The Copy is created on the Client and its existence is not known to the EnSight Server process. A Copy shares geometric data and variable data with the original Part. (This type of Part is sometimes called a “shallow copy”.)

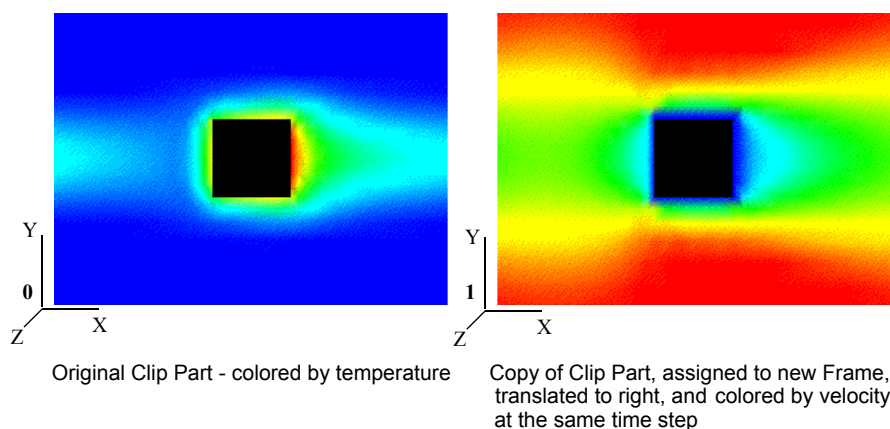

Figure 3-20  
Part Copy Example

### relationships

The relationship between a Model Part and a Copy made from a Model Part will be one of original and copy. That is, the Model Part will not be a Parent to the Copy as it is to a Created Part such as a clip.

The relationship between a Created Part and a copy made from it will also be one of original and copy since the Copy will initially regard as its Parent the same Part that the original Created Part regards as its Parent. The Parent of individual Created Parts can of course be reassigned (using the Update Parent button at the bottom of the Feature Detail Editor) but the Parent of a Created Part Copy can Not be reassigned.

A copy can be used as a Parent Part for Parts created since the create operation will operate on the original Part.

### attributes

The initial attributes assigned to a Copy are the same as those of the original Part at the time of copying. All attributes for the Copy except Element Representation (3D border, 2D full, border, Feature Angle, etc.) can be changed. The Element Representation of a Copy cannot be changed independently; a change in Element Representation of the original changes the copy as well.

### description

The description of the new Copy will be the same as the original Part with the suffix “-COPY” added (of course, you can change this description in the Desc field in the Feature Detail Editor).

### copies of copies

You can make multiple copies from a Model or Created Part, but you can NOT make copies of copies.

- frame assignment** A new frame is automatically created for each newly created Copy and the Copy is assigned to the new frame so that it can easily be moved with a local transformation. The location of the original Part and the Copy will initially coincide as well. Like all Parts, Copies of Parts can be reassigned to different frames in the General Attributes Section of the Feature Detail Editor (for that type of Part).
- usefulness** One of the most useful purposes for copies is a separation allowing for the side-by-side display of different attributes (shown in Figure 3-11). Since all attributes except Element Representation can be different, the original and the copy can be displaying different variables, different displacements, etc.  
(see [How To Copy a Part](#))
- Extract** Extracts selected Part(s) into a new, true Part, *using the Part representation in effect at the time* (full, border, or feature). If more than one Part is selected, then they are joined into a single Part. If more than one Part is selected when extract is invoked, then all will have their extracted geometry joined into a single new Part. The new Part is assigned to Frame 0.
- description** The Extract option is closely tied to Element Representation. It creates a new Part using the geometry of the current representation (what you see is what you get). Extracted Parts which are in Full Representation are actual copies of the original, but extracted Parts which are in Border Representation are only the shell or boundary of the original. Extract is often used with the Save Geometric Entities feature to save extracted Parts (and not the originals) into a smaller set of data. It is also used to create hollow Parts from solid Parts to be able to look inside a solid Part after cutting it open with the Cut feature.  
  
(see [How To Extract Part Representations](#))
- Merge** If more than one Part is selected, the Merge operation creates a new model Part on the Server host that is a combination of all selected. If only one Part is selected when Merge is invoked, then a new Part is created on the Server host that is identical but fully independent from the original Part (Note that this type of “copy” does not have the restriction on Element Representation that Part Copy does, - *all* Attributes can be reassigned - but it requires considerably more memory because it does not share the geometry with the original but now has its own copy of the geometry). The merge operation creates a new Part. The new Part is assigned the default Display Attributes and is also assigned to Frame 0.  
  
(see [How To Merge Parts](#))

## 3.5 Part Shortcuts (Right-click)

This section will describe Part shortcuts available via the right-click in the Main Part List. These shortcuts operate on the Part(s) that are highlighted in the Main Part List and *not on the Part(s) that are right-clicked*.

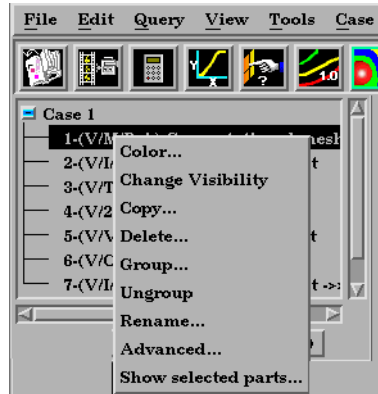

Figure 3-21  
Part Right-Click Options

Color	Brings up the “Part color, lighting, and transparency” dialogue. Choices in this dialogue will affect the Part(s) that are highlighted in the Main Part List and <i>not on the Part(s) that are right-clicked</i> .
Change Visibility	Toggles visibility of the Part(s) that are highlighted in the Main Part List and <i>not on the Part(s) that are right-clicked</i> .
Copy	Makes a “shallow copy” (only on the client) of the Part(s) that are highlighted in the Main Part List and <i>not on the Part(s) that are right-clicked</i> .
Delete	Deletes the Part(s) that are highlighted in the Main Part List <i>not the Part(s) that are right-clicked</i> .
Group/Ungroup	Groups / Ungroups the Part(s) that are highlighted in the Main Part List and <i>not on the Part(s) that are right-clicked</i> .
Rename	Renames the Part(s) that are highlighted in the Main Part List and <i>not on the Part(s) that are right-clicked</i> . Note that if more than one Part is selected, each part will be given the name typed in the Rename Dialog, but parts after the first will have the new name followed by a sequential number to make sure the Part names are unique.
Advanced	Opens up the Feature Detail Editor for the Part Type of the first highlighted part in the Part List.
Show selected parts	Opens a graphics window that renders all of the Part(s) that are highlighted in the Main Part List.



# 4 Variables

Included in this chapter:

**General Description**

**Section 4.1, Variable Selection and Activation**

**Section 4.2, Variable Summary & Palette**

**Section 4.3, Variable Creation**

## *General Description*

Variables are numerical values provided by your analysis software or created within EnSight. Variables can be dependent on server part-geometry (for example, the area of a part), and a part's geometry can be dependent on its parent part's variable values (for example, an isosurface).

## *Variable Types*

There are four types of variables: *tensor*, *vector*, *scalar*, and *constant*. Scalars and vectors can be real or complex. Symmetric tensors are defined by six values, while asymmetric tensors are defined by nine values. Vectors, such as displacement and velocity, have three values (the components of the vector) if real, or six values if complex. Scalars, such as temperature or pressure, have a single value if real, or two values if complex. Constants have a single value for the model, such as analysis time or volume. All four types can change over time for transient models.

## *Activation*

Before using a variable, it must be loaded by EnSight, a process called activation. EnSight normally activates variables as they are needed. Section 4.1 describes how to select, activate, and deactivate variables to make efficient use of your system memory.

(see Section 8.1, Color Selector)

## *Creation*

In addition to using the variables given by your analysis software, EnSight can create additional variables based on any existing variables and geometric properties of server parts. EnSight provides approximately 100 functions to make this process simpler.(see Section 8.1, Color Selector)

## *Color Palettes*

Very often you will wish to color a part according to the values of a variable. EnSight associates colors to values using a *color palette*. You have control over the number of value-levels of the palette and the type of scale, as well as control over colors and method of color gradation. You also use function palettes to specify a set of levels for a variable, such as when creating contours.

(see Section 8.1, Color Selector)

## *Queries*

You can make numerical queries about variables and geometric characteristics of Server-based parts. These queries can be at points, nodes, elements, parts, along lines, and along 1D parts. If you have transient data, you can query at one time step or over a range of time steps, looking at actual variable values or a Fast Fourier Transform (FFT) of the values. (see Section 8.1, Color Selector)

## *Plotting*

Once you have queried a variable, you can plot the result.

(see Section 8.1, Color Selector)

*From More than One Case*

Variables can come from more than one case. If more than one case has a variable with the same name, this will be treated as one variable. If a variable is applicable to one case but not another, it will not be applied to the non-applicable case(s).

*Parts*

When variables are activated or created, all parts except Particle Trace parts are updated to reflect the new variable state. Particle Trace parts will always show variables which are activated after the part's creation as zero values.

The input to all of the predefined functions includes some type of server based parts. Please be aware that parts which reside only on the client (*contours, particle traces, profiles, vector arrows, and tensor glyphs*) will not be used.

*Location*

Variables can be defined at the vertices, at the element centers, or undefined.

*User Defined Math Functions*

Users can write external variable calculator functions called User Defined Math Functions (UDMF) that can be dynamically loaded by EnSight. These functions appear in EnSight's calculator in the general function list and can be used just as any other calculator function to derive new variables.

Several examples of UDMFs can be found in the directory `$CEI_HOME/ensight80/src/math_functions/`. Please see these examples if you wish to create your own UDMFs.

When the EnSight server starts it will look in the following subdirectories for UDMF dynamic shared libraries:

```
./libudmf-devel.so (.sl) (.dll)
$ENSIGHT8_UDMF/libudmf-*.so (.sl) (.dll)
$CEI_HOME/ensight80/machines/$ENSIGHT8_ARCH/lib_udmf/libudmf-*.so (.sl) (.dll)
```

Depending on the server platform, the dynamic shared library must have the correct suffix for that platform (e.g. `.so`, `.sl`, `.dll`).

Currently, when a UDMF is used in the EnSight calculator, it is invoked for each node in the specified part(s) if all the variables operated on for the specified part(s) are node centered. If all of the variables are element centered, then the UDMF is invoked for each element in the part(s). If the variables are a mix of node and element centered values, then the node centered values are automatically converted to element centered values and then the UDMF is invoked for each element using element centered variables.

Arguments and the return type for the UDMF can be either scalar or vector EnSight variables or constants. At this time, only variable quantities and constants can be passed into UDMFs. There is no mechanism for passing in either part geometry, neighboring variables, or other information.



## 4.1 Variable Selection and Activation

All available variables, both those read in and those created within EnSight, are shown in the Feature Detail Editor (Variables), whether they have been activated or not. In addition, a variable list is included in each function requiring a variable. In this case, only the appropriate variable types are shown.

Feature Detail Editor (Variables) Double clicking on the Color Icon in the Part Mode Icon Bar opens the Feature Detail Editor (Variables).

Feature Detail Editor Variables List



Figure 4-1  
Feature Detail Editor (Variables)

*Feature Detail Editor Variables List* This list shows all variables currently available, both those read from data and those you have created within EnSight. Each row provides information about a variable.

Available Variable The description or name of the variable.

( ) or (\*) Activation status. An asterisk indicates that the variable has been activated.

Type Type of the variable:

<i>Gvn Scalar:</i>	real scalars read from the dataset (Given).
<i>Cmp Scalar:</i>	real scalars created within EnSight (Computed).
<i>Gvn Complex Scalar:</i>	complex scalars read from the dataset (Given).
<i>Cmp Complex Scalar:</i>	complex scalars created within EnSight (Computed).
<i>Gvn Vector:</i>	real vectors read from the dataset (Given).
<i>Cmp Vector:</i>	complex vectors created within EnSight (Computed).
<i>Gvn Complex Vector:</i>	complex vectors read from the dataset (Given).
<i>Cmp Complex Vector:</i>	complex vectors created within EnSight (Computed).
<i>Gvn Tensor:</i>	real tensors read from the dataset (Given).
<i>Cmp Tensor:</i>	real tensors created within EnSight (Computed).
<i>Gvn #:</i>	constants read from the dataset (Given).
<i>Cmp #:</i>	constants created within EnSight (Computed).

## 4.1 Variable Selection and Activation

<b>Result</b>	Current value of a constant variable (is blank for other types of variables). Changing the current solution time will update the value in this column to the value for the new time.
<b>Activate</b>	Clicking this button activates the variable(s) selected in the Feature Detail Editor Variables List. Activation of a variable loads its values into the memory of the EnSight Server host system. The EnSight Server then passes the necessary data to the Client. One way you can control EnSight's memory usage is to only activate the variables you want to use. Once activated, a variable becomes available in the Main Variables List and, as is described in Section 4.2, EnSight creates a default color palette for the variable.
<b>Activate All</b>	Clicking this button activates all variables listed in the Feature Detail Editor Variables List, regardless of which are selected.
<b>Deactivate</b>	Clicking this button deactivates the variable(s) selected in the Feature Detail Editor Variables List. Deactivating a variable frees up some memory on both the Client and the Server. You can activate and deactivate variables as often as you like. For example, you could activate one variable to color a part, deactivate that variable, then activate a different variable to re-color the part. Of course, if you have enough memory and a small enough model, you can simply activate all the variables and leave them activated.
<b>Extended CFD Variables...</b>	Opens the Extended CFD Variable Settings dialog. If your data defines variables or constants for density, total energy per unit volume, and momentum (or velocity), it is possible to show new variables defined by these basic variables in the Main Variables List of the GUI by utilizing the capabilities of this dialog. (See Preferences... in <a href="#">Section 6.2, Edit Menu Functions</a> ).

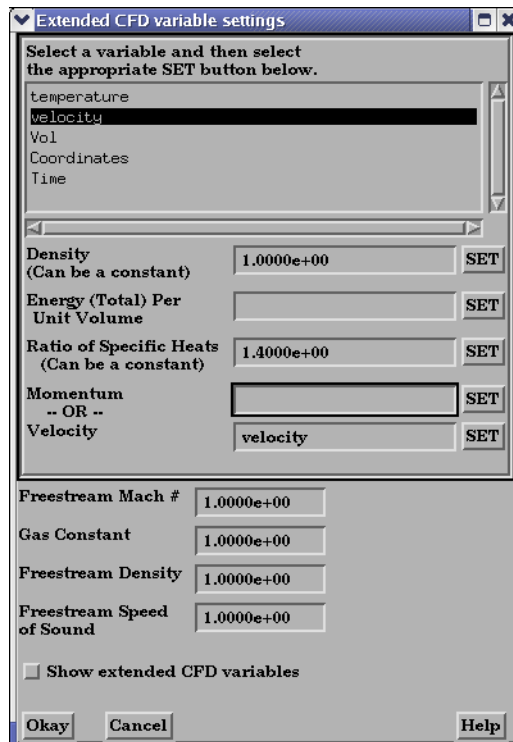

Figure 4-2  
Extended CFD Variable Settings Dialog

**WARNING** If you deactivate a created variable or any of the variables used to define it, both the values and the definition of the created variable are deleted. If you deactivate a variable used to create a part's geometry, the part will be deleted. If you deactivate a variable who's color palette has been used to color a part, the part's appearance will change.

(see [How To Activate Variables](#))

## 4.2 Variable Summary & Palette

You can visualize information about a model by representing variable values with colors, often called fringes. Fringes are an extremely effective way to visualize variable variations and levels. A variable color palette associates (or maps) variable values to colors. Palettes are also used in the creation of contours. The number of contour levels is based on the number of palette color levels, and the contour values are based on the palette level values.

EnSight uses a variable's color palette to convert numbers to colors, while you, the viewer, use them in the opposite manner—to associate a visible color with a number. If you wish, EnSight can display a color-value legend in the Main View window.

### *Default Palettes*

At least one color palette—the Coordinate color palette—always exists, even if your model has no variables. In addition, EnSight creates a color palette for each real scalar and vector variable that you activate, giving the color palette the same name as the variable. If the variable is a vector variable, the default color palette uses the vector's magnitude. Tensor variables have no palette.

Default color palettes have five color levels. Ranging from low to high, the colors are blue, cyan, green, yellow, and red (the spectral order). The numerical values mapped to these five levels are determined by first finding the value-range for the variable at the current time step when the variable is activated. The value for the lowest level is set to the minimum value. The value for the highest level is set to the maximum value. The three middle levels are spaced evenly between the lowest and highest values. For datasets with only one time step, the scheme just described works well because the variable's value range is not changing over time. However, if you have transient data, the range could vary widely at different times and since the default was based on one time step, it may not be appropriate for other time steps. EnSight can show you a histogram of the variable values over time to assist you in setting a palette for transient cases.

### *Value Levels*

A color palette can have up to 21 levels at which the variable value is specified. Each color palette level's value must be between the value at the adjoining levels, with higher levels having higher variable-values. Between levels, you select whether the scale is linear (the default), quadratic ( $2^x$ ), or logarithmic ( $\log_{10}$ ). Also, you can have EnSight use one of these scales to automatically assign values to a range of levels.

Sometimes you may wish to only visualize areas whose palette-variable values are in a limited range. You can choose to visualize other areas with a different, uniform color, or to make those areas invisible.

### *Management*

The Feature Detail Editor (Variables) enables you to manage your color palettes. You can copy, save to a file, and restore from a file existing palettes

Clicking the Variable Summary and Palette turndown button opens that dialog within the Feature Detail Editor (Variables) dialog.

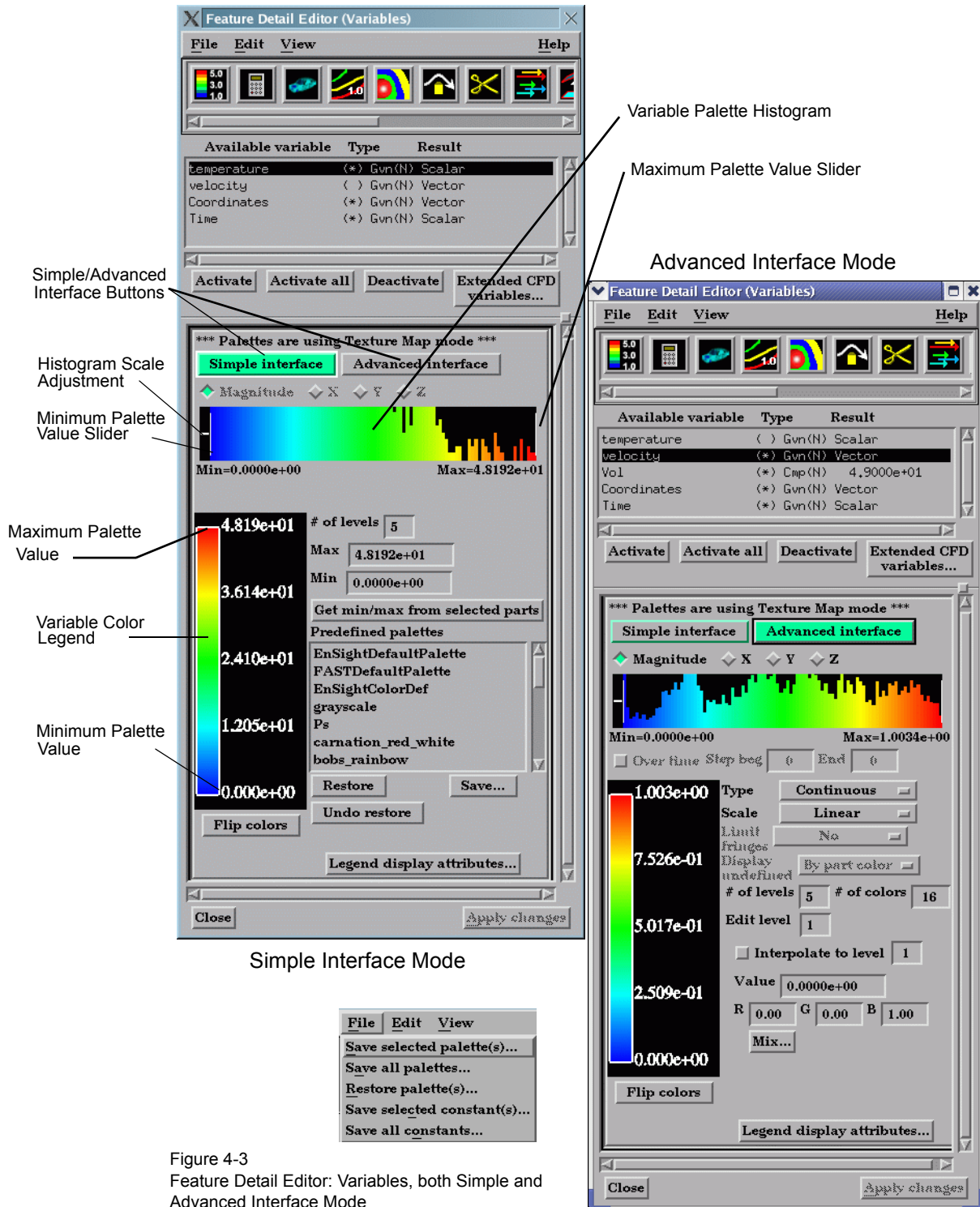

Figure 4-3  
Feature Detail Editor: Variables, both Simple and Advanced Interface Mode

**File Menu**

Clicking this button opens a pull-down menu with the following options:

Save Selected Palette(s)...

Opens the file selection dialog for the specification of a filename in which to save the selected color palette(s).

Save All Palettes...	Opens the file selection dialog for the specification of a filename in which to save all color palette(s).
Restore Palette(s)...	Opens the file selection dialog for the specification of a filename from which to restore previously saved color palettes.
Save Selected Constant(s)...	Opens the file selection dialog for the specification of a filename in which to save the selected constant values.
Save All Constant(s)...	Opens the file selection dialog for the specification of a filename in which to save all constant values.



#### *Edit Menu*

Clicking this button opens a pulldown menu with the following choice:

#### Select All

Clicking this selects all variables in the Feature Detail Editor Available Variables List.

#### Immediate Modification Toggle

Default is On. While on, any modification made in the Editor is immediately implemented by EnSight. For large problems, this may be impractical. In such instances, click this toggle off, make all desired modifications, and then implement them all at once by clicking the Apply Changes button at the bottom of the Editor dialog.

#### *Simple/Advanced Interface*

Buttons which allow the user to choose between a simple or advanced mode for this dialog.

#### *Magnitude, X, Y, Z, Toggles*

For vector variables, this controls which histogram and color palette will be displayed and edited. By default, the vector magnitude is used, however, the X, Y, and Z components of the vector are also available.

#### *Variable Palette Histogram*

This histogram shows the relative number of nodes at which the value of the selected variable is within the range represented by a particular color band. The two vertical white slider bars are used to interactively set the minimum and maximum variable values to be used in the variable's color palette and these will show up in the Legend both within the turn-down area and within the Graphics Window. The small horizontal white line on the left hand side can be used to interactively adjust the vertical scale of the histogram.

#### *Over Time Step Toggle & Beg, End Fields*

Toggles on/off the automatic assignment of values to palette levels using the palette-variable's value range over multiple time steps which are specified in the Beg and End fields to the right of the toggle. This function is only available when you are using transient data. All other attributes of the color palette (including the number of levels, colors, type, etc.) are not changed.

<b>Type</b>	<p>This button opens a pop-up menu for the selection of the desired type of color gradation. Both the legend in the turn-down area and the legend in the Graphics Window (if visible) are affected. Options are:</p> <p><i>Continuous</i> displays graduated color variation across or along each element interpolating the color across each element based on the value of the variable at the nodes. If the variable tied to the palette is defined at the element centers it will be averaged to the nodes for display.</p> <p><i>Banded</i> displays discrete color values for each value range, but interpolates the location demarcation line within an element.</p> <p><i>Constant</i> displays each element with one color for the entire element rather than interpolating the color across the element using values at the nodes. The color of the first node encountered is used.</p>
<b>Scale</b>	<p>This button opens a pop-up dialog for the selection of the desired type of scale for the value-separation of levels and color gradation. The options are:</p> <p><i>Linear</i> scale divisions, where the value-separation of levels is uniform and values map linearly to the colors.</p> <p><i>Quadratic</i> scale divisions, where the value-separations of levels are not equal, but instead are based on the second order of the variable (value<sup>2</sup>). Level-values always increasing upwards. For example, for five levels with a low-level value of 0 and a high-level value of 16, the linear scale would be 0, 4, 8, 12, 16 while the quadratic scale would be 0, 1, 4, 9, 16.</p> <p><i>Logarithmic</i> scale divisions, where the value-separations of levels are not equal, but instead are based on the base-10 logarithm of the variable value (log<sub>10</sub>). Level-values always increasing upwards. For example, for five levels with a low-level value of 1 and a high-level value of 10000, the linear scale would be 1, 2500, 5000, 7500, 10000 while the logarithmic scale would be 1, 10, 100, 1000, 10000.</p>
<b>Limit Fringes</b>	<p>This button allows you to select how you wish to display elements with node values above and below the range of the palette scale values. This option only works for hidden surface mode, and is only available for Edit &gt; Preferences &gt; Color &gt; Color by RGB. Options are:</p> <p><i>No</i> limit on values. Values above and below are colored with color of the corresponding end of the range (no interpolation).</p> <p><i>By Model Color</i> option colors values outside the function range with the current part- color (the color of the part when its Color By Palette attribute is None).</p> <p><i>By Invisible</i> option does not display elements whose node values are all above or below the value-range of the palette.</p>
<b>Display Undefined</b>	<p>If the variable is not defined, the element cannot be colored according to the color palette. In this case, the element will be colored by the Part Color, or the element will become invisible. This option is only available for Edit &gt; Preferences &gt; Color &gt; Color by RGB.</p>
<b># of Levels</b>	<p>This field specifies the number of value-levels for the variable color palette, which are shown beside the Legend color bar. The number of levels is independent of the Type and Scale, and can range from 2 to 21 with the default being 5.</p>
<b># of Colors</b>	<p>This field specifies the number of colors in each level. This is readily apparent if you set the Type to Banded. This option is only available for Edit &gt; Preferences &gt; Color &gt; Color by Textures</p>
<b>Min</b>	<p>For the Simple Interface, this field is used to specify the variable value for the bottom level.</p>
<b>Max</b>	<p>For the Simple Interface, this field is used to specify the variable value for the top level.</p>

<i>Get min/max from selected parts</i>	This will cause the min and max to be reset based on the values of the variable in the selected parts.
<i>Edit Level</i>	Selection of the level you wish to edit, selected with stepper buttons, by entering a value in the field, or by clicking the mouse pointer on the desired level in the Variable Color Legend area. Levels start at 1 and count up from lower end. You can change the variable-value and color assigned to any level. Also, you can have EnSight interpolate value-levels and colors over a range of levels.
<i>Interpolate to Level Toggle and Field</i>	If this option is toggled-on while you are specifying a value (or color), the value (or color) of EnSight adjusts the values (or colors) of intermediate levels between the current level and the specified Interpolate To Level according the specified Scale type.
<i>Value</i>	This field specifies the variable value for the current palette level.
<i>R G B Fields</i>	These fields are used to specify the color to use for the current palette level.
<i>Mix...</i>	Clicking this button opens the Color Selector dialog which provides an alternative to the RGB fields for the specification of the color to use for the current palette level. (see <a href="#">Section 8.1, Color Selector</a> )
<i>Predefined Palettes</i>	For the Simple Interface only, shows a list of all predefined color palettes.
<i>Restore</i>	For the Simple Interface only. Restores the palette selected in the Predefined Palettes list.
<i>Save...</i>	For the Simple Interface only. Will bring up a file dialog to allow saving of the currently defined color palette.
<i>Undo Restore</i>	For the Simple Interface only. Will set the color palette definition back to what existed before the previous Restore.
<i>Flip Colors</i>	Reverses colors in the palette.
<i>Legend Display Attributes ...</i>	Clicking this button opens a pop-up message which reminds you that additional options for the modification of Legend display attributes may be found in the Annot Mode Icon Bar. (See <a href="#">How To Create Color Legends</a> , <a href="#">How To Edit Color Palettes</a> )

## 4.3 Variable Creation

You can create additional variables based on existing data. Typical mathematical operations, as well as many special built-in functions, enable you to produce simple or complex equations for new variables. Some built-in functions enable you to use values based on the geometric characteristics of server parts. In general, created variables are available for any process, just like given variables. If you have transient data, a time change will recompute the created variable values.

Often an analysis program produces a set of basic results from which other results can be derived. For example, if a computational fluid dynamics analysis gives you density, momentum and total energy, you can derive pressure, velocity, temperature, mach number, etc. EnSight provides many of these common functions for you, or you can enter the equation(s) and build your own.

As another example, suppose you would like to normalize a given scalar or vector variable according to its maximum value, or according to the value at a particular node. Variable creation enables you to easily accomplish such a task. The more familiar you become with this feature, the more uses you will discover.

EnSight allows variables to be defined at vertices (nodes) or element centers. If a new variable is created from a combination of nodal and element based variables, such a new variable will always be element based.

*Note: Measured Variables are not supported by this functionality*



*Building Expressions* The Feature Detail Editor (Variables) dialog Variable Creation turn-down section provides function selection lists, calculator buttons, and feedback guidance to aid you in building the working expression (or equation) for a new variable. You can use three types of values in an expression: constants, scalars, and vectors.

<i>Constants</i>	<p>A <i>constant</i> in a variable expression can be a...</p> <ul style="list-style-type: none"> <li>• number</li> <li>• constant variable from the Active Variables list</li> <li>• scalar variable at a particular node/element (component and node/element number in brackets)</li> <li>• vector variable component at a particular node /element (component and node/element number in brackets)</li> <li>• coordinate component at a particular node/element (component and node/element number in brackets)</li> <li>• any of the previous three at a particular time step (time step in braces right after the variable name) <i>(Note: This only works for model variables, not created ones)</i></li> <li>• Math function</li> <li>• General function that produces a constant</li> </ul>	<p>for example...</p> <p>3.56</p> <p>Analysis_Time</p> <p>temperature[25]</p> <p>velocity[Z][25]</p> <p>coordinate[X][25]</p> <p>temperature{15}[25]</p> <p>velocity{15}[Z][25]</p> <p>coordinate{15}[X][25]</p> <p>COS(1.5708)</p> <p>AREA(plist)</p>
<i>Scalars</i>	<p>A <i>scalar</i> in a variable expression can be a...</p> <ul style="list-style-type: none"> <li>• Scalar variable from the Active Variables list</li> <li>• vector variable component (component in brackets)</li> <li>• coordinate component (component in brackets)</li> <li>• any of the previous three at a particular time step (time step in braces right after the variable name) <i>(Note: This only works for model variables, not created ones)</i></li> <li>• General function that produces a scalar</li> </ul>	<p>for example...</p> <p>pressure</p> <p>velocity[Z]</p> <p>coordinate[Y]</p> <p>pressure{29}</p> <p>velocity{29}[Z]</p> <p>coordinate{29}[Y]</p> <p>Divergence(plist,velocity)</p>
<i>Vectors</i>	<p>A <i>vector</i> in a variable expression can be a...</p> <ul style="list-style-type: none"> <li>• vector variable from the Active Variables list</li> <li>• coordinate name from the Active Variables list</li> <li>• any of the previous two at a particular time step (time step in braces right after the variable name) <i>(Note: This only works for model variables, not created ones)</i></li> <li>• General function that produces a vector</li> </ul>	<p>for example...</p> <p>velocity</p> <p>coordinate</p> <p>velocity{9}</p> <p>coordinate{9}</p> <p>Vorticity(plist,velocity)</p>

### Examples of Expressions and How To Build Them

The following are some example variable expressions, and how they can be built. These examples assume *Analysis\_Time*, *pressure*, *density*, and *velocity* are all given variables.

<i>Working Expression</i>	<i>Discussion and How To Build It</i>
-13.5/3.5	A true constant since it does not change over time. To build it, type on the keyboard or click on the Variable Creation dialog calculator buttons <code>-13.5/3.5</code>
<i>Analysis_Time</i> /60.0	A simple example of modifying a given constant variable. If <i>Analysis_Time</i> is in seconds, this expression would give you the value in minutes. To build it, select <i>Analysis_Time</i> from the Active variable list and then type or click <code>/60.0</code> .
<i>velocity</i> * <i>density</i>	This expression is momentum, which is a vector. To build it, select <i>velocity</i> from the Active Variables list, type or click <code>*</code> , then select <i>density</i> from the Active Variable list.
<code>SQRT(pressure[73] * 2.5)+ velocity[X][73]</code>	This says, take the pressure at node (or element if pressure is an element center based variable) number 73, multiply it by 2.5, take the square root of the product, and then add to that the x-component of velocity at node (or element) number 73. To build it, select <i>SQRT</i> from the Math function list, select <i>pressure</i> from the Active Variables list, type <code>[73]*2.5)+</code> , select <i>velocity</i> from the Active Variable list, then type <code>[X][73]</code>
<code>pressure{19}</code>	This is a scalar, the value of pressure at time step 19. It does not change with time. To build it, select <i>pressure</i> from the Active Variables list, then type <code>{19}</code> . (Note: variable must be a model variable, not a computed variable)
<code>MAX(plist,pressure)</code>	<i>MAX</i> is one of the built-in General functions. This expression calculates the maximum pressure value for all the nodes of the selected parts. To build it, type or click <code>(</code> , select <i>MAX</i> from the General function list and follow the interactive instructions that appear in the Feedback area of this dialog (in this case, to select the parts, click Okay, and select <i>pressure</i> from the Active Variable list).
<code>(pressure /pressure_max)^2</code>	This scalar is essentially the normalized pressure, squared. To build it, first build the preceding <code>MAX(plist,pressure)</code> expression and name it "pressure_max". Then to build this expression, select <i>pressure</i> from the Active Variables list, type or click <code>/</code> , select <i>pressure_max</i> from the Active Variables list, then type or click <code>)^2</code> .

Notice in the last example how a complex equation can be broken down into several smaller expressions. This is necessary as EnSight can compute only one variable at a time. Calculator limitations include the following:

1. The variable name cannot be used in the expression.

The following is invalid:

$$\text{temperature} = \text{temperature} + 100$$

Instead use new variable:

$$\text{temperature2} = \text{temperature} + 100$$

2. The result of a function cannot be used in an expression.

The following is invalid:

$$\text{norm\_press\_sqr} = (\text{pressure} / \text{MAX}(\text{plist}, \text{pressure}))^2$$

Instead use two steps:

$$p\_max = \text{MAX}(\text{plist}, \text{pressure})$$

then:

$$\text{norm\_press\_sqr} = (\text{pressure} / p\_max)^2$$

3. Neither created parts, changing geometry model parts, computed variables, nor coordinates can be used with a time calculation (using {}). If one of these is selected when you use {}, the calculation will fail with an error message.

4. Because calculations occur only on server based parts, client based parts are ignored when included in the part list of the pre-defined functions, and variable values may be undefined.

Clicking the Calculator Icon opens the Feature Detail Editor (Calculator) dialog.

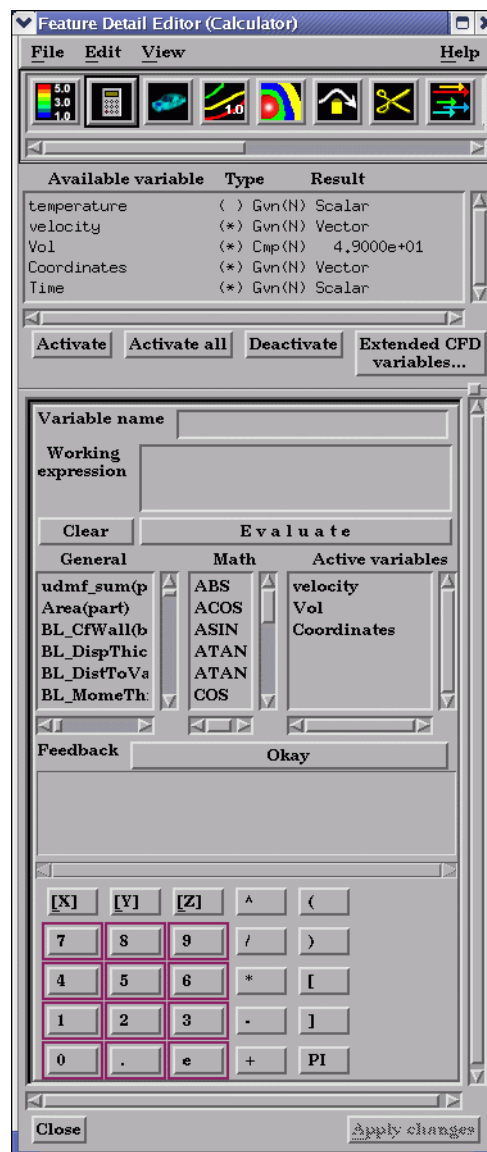

Figure 4-4  
Feature Detail Editor (Calculator) dialog

### 4.3 Variable Creation

<b>Variable Name</b>	This field is used to specify the name for the variable being created. Built-in general functions will provide a default, but they can be modified here. Variable names must not start with a numeric digit and must not contain any of the following reserved characters: ( [ { + @ ! * \$ ) ] } - space # ^ /
<b>Working Expression</b>	The expression or equation for the new variable is presented in this area. Interaction with the expression takes place here, either directly by typing in values and variable names, etc., or indirectly by selecting built-in functions and clicking calculator buttons.
<b>Clear</b>	Clicking this button clears the Variable name field, Working Expression area, Feedback area, and deselects any built-in function.
<b>Evaluate</b>	Clicking this button produces the new variable defined in the working expression area. Until you click this button, nothing is really created. The selection commands specify to which parts the new variable should be applied.
<b>General</b>	Scroll this list of built-in functions provided for your convenience. Click on a function to insert it into your Working Expression. For some functions, the Feedback Window provides interactive instructions.
<b>Area</b>	<b>Area</b> (any part(s)) Computes a constant variable whose value is the area of the selected parts. If a part is composed of 3D elements, the area is of the border representation of the part. The area of 1D elements is zero.
<b>Boundary Layer</b>	<b>BL_CfWall</b> (boundary part(s), velocity, viscosity, free density, free velocity, grad).
<b>Wall Skin Friction Coefficient</b>	Computes a scalar variable which is the skin-friction coefficient $C_f$ , defined as:

$$C_f = \frac{\tau_w}{0.5\rho_\infty(V_\infty)^2}$$

where:

$$\tau_w = \mu_w \left( \frac{\partial u}{\partial n} \right)_{n=0} = \text{fluid shear stress at the wall}$$

$\mu_w$  = dynamic viscosity of the fluid at the wall  
May be spatially and/or temporarily varying quantity (usually a constant).

$n$  = distance profiled normal to the wall

$\rho_\infty$  = freestream density

$V_\infty$  = freestream velocity magnitude

This is a non-dimensionalized measure of the fluid shear stress at the surface. An important aspect of the Skin Friction Coefficient is:

$C_f = 0$ , indicates boundary layer separation.

boundary part	2D part
velocity	vector variable
viscosity	scalar variable, constant variable, or constant number
free density	constant number
free velocity	constant number
grad	-1 = flags the computing of the velocity-magnitude gradient via 4-point interpolation. vector variable = Grad(velocity magnitude)

Note: See [Section 7.18, Boundary Layer Variables Create/Update](#)

**Boundary Layer  
Displacement  
Thickness**

*BL\_DisplacementThickness*(boundary part(s), velocity, density, ymax, 0, grad).

Computes a scalar variable which is the boundary-layer displacement thickness  $\delta^*$  defined as:

$$\delta^* = \frac{1}{U} \int_0^{\delta} (\rho_e U - \rho u) dn$$

where:

- $n$  = distance profiled normal to the wall
- $\delta$  = boundary-layer thickness (distance to edge of boundary layer)
- $\rho$  = density at given profile location
- $\rho_e$  = density at the edge of the boundary layer
- $u$  = magnitude of the velocity component parallel to the wall at a given profile location in the boundary layer
- $U$  =  $u$  at the edge of the boundary layer
- $y_{\max}$  = distance from wall to freestream
- grad = flag for gradient of velocity magnitude

Provides a measure for the effect of the boundary layer on the “outside” flow. The boundary layer causes a displacement of the streamlines around the body.

boundary part	2D part
velocity	vector variable
density	scalar variable (compressible flow), constant number (incompressible flow)
ymax	constant number > 0 = Baldwin-Lomax-Spalart algorithm 0 = convergence algorithm (See <a href="#">Algorithm Note</a> under Boundary Layer Thickness)
0	only option currently
grad	-1 = flags the computing of the velocity-magnitude gradient via 4-point interpolation. vector variable = Grad(velocity magnitude)

Note: See [Section 7.18, Boundary Layer Variables Create/Update](#)

**Boundary Layer  
Distance to Value  
from Wall**

*BL\_DistanceToValue*(boundary part(s), scalar, scalar value).

Computes a scalar variable which is the distance  $d$  from the wall to the specified value defined as

$$d = n|_{f(\alpha) = c}$$

where:

- $n$  = distance profile  $d$  normal to boundary surface
- $f(\alpha)$  = scalar field (variable)
- $\alpha$  = scalar field values
- $c$  = scalar value at which to assign  $d$

boundary part	0D, 1D, or 2D part
scalar	scalar variable
scalar value	constant number

Note: See [Section 7.18, Boundary Layer Variables Create/Update](#)

Boundary Layer  
**Momentum  
Thickness**

*BL\_MomeThick*(boundary part(s), velocity, density, ymax, 0, 0, grad).  
Computes a scalar variable which is the boundary-layer momentum thickness  $\theta$  defined as:

$$\theta = \frac{1}{\rho_e U^2} \int_0^{\delta} (U - u) \rho u dn$$

where:

- $n$  = distance profiled normal to the wall
- $\delta$  = boundary-layer thickness (or distance to edge of boundary layer)
- $\rho$  = density at given profile location
- $\rho_e$  = density at the edge of the boundary layer
- $u$  = magnitude of the velocity component parallel to the wall at a given profile location in the boundary layer
- $U$  =  $u$  at the edge of the boundary layer
- $y_{\max}$  = distance from wall to freestream
- grad = flag for gradient of velocity magnitude

Relates to the momentum loss in the boundary layer.

boundary part	2D part
velocity	vector variable
density	scalar variable (compressible flow), constant number (incompressible flow)
ymax	constant number > 0 = Baldwin-Lomax-Spalart algorithm 0 = convergence algorithm (See <a href="#">Algorithm Note</a> under Boundary Layer Thickness)
0	only option currently
0	only option currently
grad	-1 = flags the computing of the velocity-magnitude gradient via 4-point interpolation. vector variable = Grad(velocity magnitude)

Note: See [Section 7.18, Boundary Layer Variables Create/Update](#)

Boundary Layer  
**Scalar**

*BL\_Scalar*(boundary part(s), velocity, scalar, ymax, grad).  
Computes a scalar variable which is the scalar value of the corresponding scalar field at the edge of the boundary layer. The function extracts the scalar value while computing the boundary-layer thickness (see Boundary Layer **Thickness**).

where:

- $y_{\max}$  = distance from wall to freestream
- grad = flag for gradient of velocity magnitude

boundary part	2D part
velocity	vector variable
scalar	scalar variable
ymax	constant number > 0 = Baldwin-Lomax-Spalart algorithm 0 = convergence algorithm (See <a href="#">Algorithm Note</a> under Boundary Layer Thickness)
grad	-1 = flags the computing of the velocity-magnitude gradient via 4-point interpolation. vector variable = Grad(velocity magnitude)

**Boundary Layer Shape Parameter** *BL\_Shape* is not explicitly listed in the general function list, but can be computed as a scalar variable via the calculator by dividing a displacement thickness by a momentum thickness, i.e.

$$H = \delta^*/\theta$$

where:

- $\delta^*$  = boundary-layer displacement thickness
- $\theta$  = boundary-layer momentum thickness

Used to characterize boundary-layer flows, especially to indicate potential for separation. This parameter increases as a separation point is approached, and varies rapidly near a separation point.

Note: Separation has not been observed for  $H < 1.8$ , and definitely has been observed for  $H = 2.6$ ; therefore, separation is considered in some analytical methods to occur in turbulent boundary layers for  $H = 2.0$ .

*In a Blasius Laminar layer (i.e. flat plate boundary layer growth with zero pressure gradient),  $H = 2.605$ . Turbulent boundary layer,  $H \sim 1.4$  to  $1.5$ , with extreme variations  $\sim 1.2$  to  $2.5$ .*

**Boundary Layer Thickness** *BL\_Thick*(boundary part(s), velocity, ymax, grad). Computes a scalar variable which is the boundary-layer thickness  $\delta$  defined as:

$$\delta = n|_{u/U = 0.995}$$

The distance normal from the surface to where  $u/U = 0.995$ ,

where:

- $u$  = magnitude of the velocity component parallel to the wall at a given location in the boundary layer
- $U$  = magnitude of the velocity just outside the boundary layer

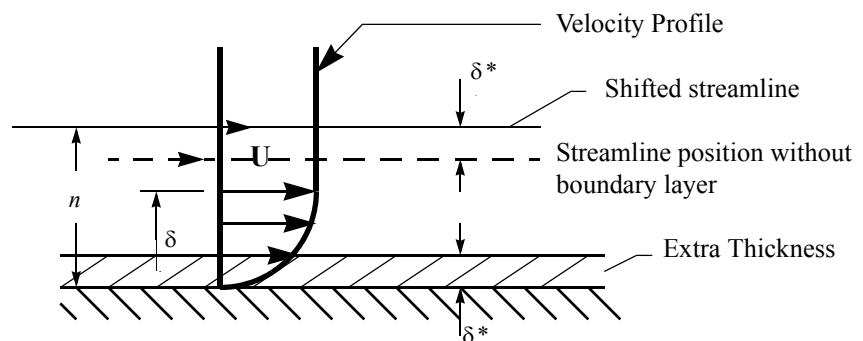

boundary part	2D part
velocity	vector variable
ymax	constant number > 0 = Baldwin-Lomax-Spalart algorithm 0 = convergence algorithm (See <a href="#">Algorithm Note</a> below)
grad	-1 = flags the computing of the velocity-magnitude gradient via 4-point interpolation. vector variable = Grad(velocity magnitude)

Note: See [Section 7.18, Boundary Layer Variables Create/Update](#)

**Algorithm Note:** The  $y_{max}$  argument allows the edge of the boundary layer to be approximated by two different algorithms, i.e. the Baldwin-Lomax-Spalart and convergence algorithms. Both schemes profile velocity data normal to the boundary surface, or wall. Specifying  $y_{max} > 0$  leverages results from both the Baldwin-Lomax and vorticity functions over the entire profile to produce a fading function that approximates the edge of the boundary layer. Whereas, specifying  $y_{max} = 0$  uses velocity and velocity gradient differences to converge to the edge of the boundary layer.

Please see the following references for more detailed explanations.

P.M. Gerhart, R.J. Gross, & J.I. Hochstein, Fundamentals of Fluid Mechanics, 2nd Ed., (Addison-Wesley: New York, 1992)

P. Spalart, A Reasonable Method to Compute Boundary-Layer Parameters from Navier-Stokes Results, (Unpublished: Boeing, 1992)

H. Schlichting & K. Gersten, Boundary Layer Theory, 8th Ed., (Springer-Verlag: Berlin, 2003)

Boundary Layer  
 $y_1^+$  off Wall

*BL\_Y1Plus*(boundary part(s), velocity, density, viscosity, free density, free velocity, grad).  
Computes a scalar variable which is the coefficient off the wall by one element height  $y_1^+$  defined as

$$y_1^+ = \frac{y_1 \rho_w}{\mu_w} \sqrt{\frac{\tau_w}{\rho_w}}$$

where:

$n$  = distance profiled normal to the wall

$\tau_w = \mu_w \left( \frac{du}{dn} \right)_{n=0}$  = fluid shear stress at wall

$\mu_w$  = dynamic viscosity of fluid at wall  
May be spatially and/or temporally varying quantity (usually a constant)

$\rho_\infty$  = freestream density

$V_\infty$  = freestream velocity magnitude

$\rho_w$  = density at the wall

$y_1$  = first element height profiled normal to wall

Normally  $y^+$  is used to estimate or confirm the required 1st grid spacing for proper capturing of viscous-layer properties. The values are dependent on various factors including, what variables at the wall are sought, the turbulent models used, and whether the law of the wall is used or not. Consult a boundary-layer text for correct interpolation of the values for your application.

boundary part	2D part
velocity	vector variable
density	scalar variable
viscosity	scalar variable, constant variable, or constant number
free density	constant number
free velocity	constant number
grad	-1 = flags the computing of the velocity-magnitude gradient via 4-point interpolation. vector variable = Grad(velocity magnitude)



**Case Map***CaseMap* (2D or 3D part(s), case to map from, scalar/vector/tensor)

Finds the specified scalar, vector, or tensor variable values for the specified part(s) from the indicated case.

case to map from	constant number
scalar/vector/tensor	scalar, vector, or tensor variable

**Coefficient***Coeff* (any 1D or 2D part(s), scalar, component)Computes a constant variable whose value is a coefficient  $C_x$ ,  $C_y$ , or  $C_z$  such that

$$C_x = \int_S f n_x dS \quad C_y = \int_S f n_y dS \quad C_z = \int_S f n_z dS$$

where:

 $f$  = any scalar variable $S$  = 1D or 2D domain $n_x$  = x component of normal $n_y$  = y component of normal $n_z$  = z component of normal

component	[X], [Y], or [Z]
-----------	------------------

Specify [X], [Y], or [Z] to get the corresponding coefficient.

*Note: Normal for a 1D part will be parallel to the plane of the plane tool.***Complex***Cmplx*(any part(s), scalar/vector(real portion), scalar/vector(complex portion), [optional frequency(Degrees)])

Creates a complex scalar or vector from two scalar or vector variables. The frequency is optional and is used only for reference.

$$Z = A + Bi$$

real portion	scalar or vector variable
complex portion	scalar or vector variable (but must be same as real portion)
[frequency]	constant number (optional)

**Complex  
Argument***CmplxArg* (any part(s), complex scalar or vector)

Computes the Argument of a complex scalar or vector. The resulting scalar is given in degrees and will be in the range -180 and 180 degrees.

$$\text{Arg} = \text{atan}(V_i/V_r)$$

**Complex  
Conjugate***CmplxConj* (any part(s), complex scalar or vector)

Computes the Conjugate of a complex scalar of vector. Returns a complex scalar or vector where:

$$N_r = V_r$$

$$N_i = -V_i$$

**Complex  
Imaginary***CmplxImag* (any part(s), complex scalar or vector)

Extracts imaginary portion of a complex scalar or vector into a real scalar or vector.

$$N = V_i$$

**Complex  
Modulus***CmplxModu* (any part(s), complex scalar or vector)

Returns a real scalar/vector which is the modulus of the given scalar/vector

$$N = \text{SQRT}(V_r * V_r + V_i * V_i)$$

**Complex  
Real***CmplxReal*(any part(s), complex scalar or vector)

Extracts the real portion of a complex scalar or vector into a real scalar or vector.

$$N = V_r$$

**Complex Transient Response** *CmplxTransResp*(any part(s), complex scalar or vector, constant PHI(0.0-360.0 Degrees))  
 Returns a real scalar or vector which is the real transient response:

$$\text{Re}(V_t) = \text{Re}(V_c)\text{Cos}(\text{phi}) - \text{Im}(V_c)\text{Sin}(\text{phi})$$

which is a function of the transient phase angle “phi” defined by:

$$\text{phi} = 2 \text{ Pi } f t$$

where

t = the harmonic response time parameter

f = frequency of the complex variable “Vc”

and the complex field “Vc”, defined as:

$$V_c = V_c(x,y,z) = \text{Re}(V_c) + i \text{Im}(V_c)$$

where

Vc = the complex variable field

Re(Vc) = the Real portion of Vc

Im(Vc) = the imaginary portion of Vc

i = Sqrt(-1)

Note, the transient complex function, was a composition of Vc and Euler’s relation, namely:

$$V_t = V_t(x,y,z,t) = \text{Re}(V_t) + i \text{Im}(V_t) = V_c * e^{(i \text{ phi})}$$

where:

$$e^{(i \text{ phi})} = \text{Cos}(\text{phi}) + i \text{Sin}(\text{phi})$$

The real portion Re(Vt), is as designated above:

**Note: this function is only good for harmonic variations, thus fields with a defined frequency!**

phi angle	constant number between 0 and 360 degrees.
-----------	--

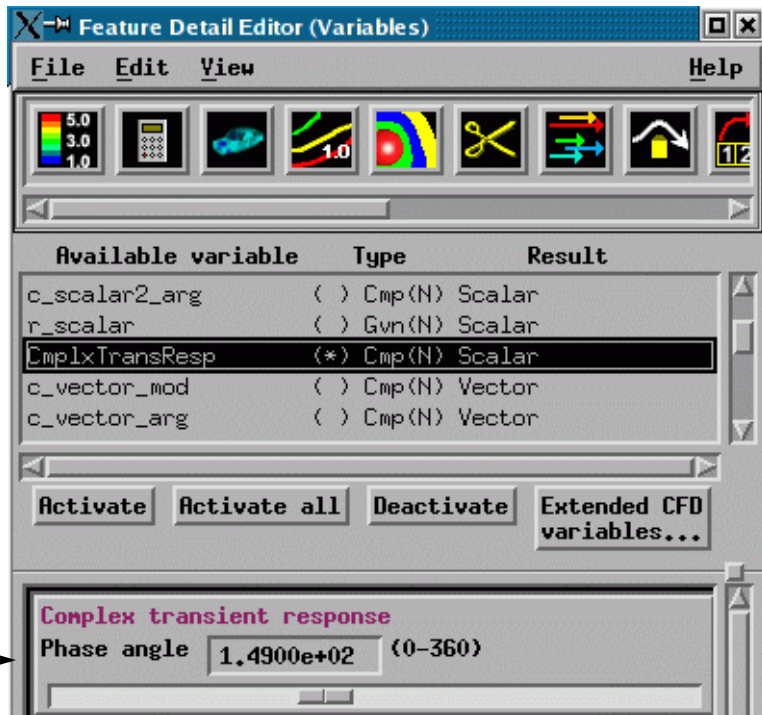

Note: A special area becomes available in the Feature Detail Editor (Variables) and Feature Detail Editor (Calculator) when you highlight a variable of this type - allowing you to modify the phase angle (phi) easily with a slider.

**Curl** *Curl* (any part(s), vector)  
 Computes a vector variable which is the curl of the input vector

$$\text{Curl}_f = \bar{\nabla} \times \vec{f} = \left( \frac{\partial f_3}{\partial y} - \frac{\partial f_2}{\partial z} \right) \hat{i} + \left( \frac{\partial f_1}{\partial z} - \frac{\partial f_3}{\partial x} \right) \hat{j} + \left( \frac{\partial f_2}{\partial x} - \frac{\partial f_1}{\partial y} \right) \hat{k}$$

**Density** *Density*(any part(s), pressure, temperature, gas constant).  
 Computes a scalar variable which is the density  $\rho$ , defined as:

$$\rho = \frac{p}{TR}$$

where:  $p$  = pressure  
 $T$  = temperature  
 $R$  = gas constant

pressure	scalar variable
temperature	scalar variable
gas constant	scalar variable, constant variable, or constant number

**Log of Normalized Density** *DensityLogNorm* (any part(s), density, freestream density)  
 Computes a scalar variable which is the natural log of Normalized Density defined as:

$$\ln \rho_n = \ln(\rho / \rho_i)$$

where:  $\rho$  = density

$\rho_i$  = freestream density

density	scalar variable, constant variable, or constant number
freestream density	constant variable or constant number

**Normalized Density** *DensityNorm* (any part(s), density, freestream density)  
 Computes a scalar variable which is the Normalized Density  $\rho_n$  defined as:

$$\rho_n = \rho / \rho_i$$

where:  $\rho$  = density

$\rho_i$  = freestream density

density	scalar variable, constant variable, or constant number
freestream density	constant variable or constant number

**Normalized Stagnation Density** *DensityNormStag* (any part(s), density, total energy, velocity, ratio of specific heats, freestream density, freestream speed of sound, freestream velocity magnitude)

Computes a scalar variable which is the Normalized Stagnation Density  $\rho_{on}$  defined as:

$$\rho_{on} = \rho_o / \rho_{oi}$$

where:  $\rho_o$  = stagnation density

where:  $\rho_{oi}$  = freestream stagnation density

density	scalar variable, constant variable, or constant number
total energy	scalar variable
velocity	vector variable
ratio of specific heats	scalar variable, constant variable, or constant number
freestream density	constant variable or constant number
freestream speed of sound	constant variable or constant number
freestream velocity magnitude	constant variable or constant number

**Stagnation Density**

*DensityStag* (any part(s), density, total energy, velocity, ratio of specific heats)  
 Computes a scalar variable which is the Stagnation Density  $\rho_o$  defined as:

$$\rho_o = \rho \left( 1 + \left( \frac{\gamma - 1}{2} \right) M^2 \right)^{1/(\gamma - 1)}$$

where:  $\rho$  = density  
 $\gamma$  = ratio of specific heats  
 $M$  = mach number  
 total energy must be a scalar  
 velocity must be a vector

density	scalar variable, constant variable, or constant number
total energy	scalar variable
velocity	vector variable
ratio of specific heats	scalar variable, constant variable, or constant number

**Distance Between Nodes**

*Dist2Nodes*(any part(s), nodeID1,nodeID2).  
 Computes a constant, positive variable that is the distance between any two nodes. Searches down the part list until it finds nodeID1, then searches until it finds nodeID2 and returns Undef if nodeID1 or nodeID2 cannot be found. Nodes are designated by their node id's, so the part must have node ids. (Note that most created parts do not have node ids.) Note: to find the distance between two nodes on different parts, or between two nodes if one or both don't have ids, or the ids are not unique for the model (namely, more than one part has the same node id) use the line tool. See the Advanced Usage section of [How To Use the Line Tool](#).

nodeID1	constant number
nodeID2	constant number

**Divergence**

*Div* (2D or 3D part(s), vector)  
 Computes a scalar variable whose value is the divergence defined as:

$$Div = \frac{\partial u}{\partial x} + \frac{\partial v}{\partial y} + \frac{\partial w}{\partial z}$$

where  $u, v, w$  = velocity components in x,y,z directions.

**Element to Node**

*ElemToNode* (any part(s), element-based scalar or vector).  
 Averages an element based variable to produce a node based variable.

**Energy:**

**Total Energy**

*EnergyT* (any part(s), density, pressure, velocity, ratio of specific heats).  
 Computes a scalar variable of total energy per unit volume

$$e = \rho \left( e_i + \frac{V^2}{2} \right) \quad \text{Total Energy} \quad \text{where: } \rho = \text{density}$$

$$e_i = e_o - \frac{V^2}{2} \quad \text{Internal Energy} \quad V = \text{Velocity}$$

Or based on gamma, pressure and velocity:

$$e_o = \frac{e}{\rho} \quad \text{Stagnation Energy} \quad e = \frac{p}{(\gamma - 1)} + \rho \frac{V^2}{2}$$

density	scalar variable, constant variable, or constant number
pressure	scalar variable
velocity	vector variable
ratio of specific heats	scalar variable, constant variable, or constant number

**Kinetic Energy** *KinEn* (any part(s), velocity, density)

Computes a scalar variable whose value is the kinetic energy  $E_k$  defined as:

$$E_k = \frac{1}{2}\rho V^2$$

where  $\rho$  = density

$V$  = Velocity variable

velocity	vector variable
density	scalar variable, constant variable, or constant number

**Enthalpy**

*Enthalpy* (any part(s), density, total energy, velocity, ratio of specific heats)

Computes a scalar variable which is Enthalpy  $h$  defined as:

$$h = \gamma \left( \frac{E}{\rho} - \frac{V^2}{2} \right)$$

where:  $E$  = total energy per unit volume

$\rho$  = density

$V$  = velocity magnitude

$\gamma$  = ratio of specific heats

density	scalar variable, constant variable, or constant number
total energy	scalar variable
velocity	vector variable
ratio of specific heats	scalar variable, constant variable, or constant number

**Normalized Enthalpy**

*EnthalpyNorm* (any part(s), density, total energy, velocity, ratio of specific heats, freestream density, freestream speed of sound)

Computes a scalar variable which is Normalized Enthalpy  $h_n$  defined as:

$$h_n = h/h_i$$

where:  $h$  = enthalpy

$h_i$  = freestream enthalpy

density	scalar variable, constant variable, or constant number
total energy	scalar variable
velocity	vector variable
ratio of specific heats	scalar variable, constant variable, or constant number
freestream density	constant variable or constant number
freestream speed of sound	constant variable or constant number

**Stagnation Enthalpy**

*EnthalpyStag* (any part(s), density, total energy, velocity, ratio of specific heats)

Computes a scalar variable which is Stagnation Enthalpy  $h_o$  defined as:

$$h_o = h + \frac{V^2}{2}$$

where:  $h$  = enthalpy

$V$  = velocity magnitude

density	scalar variable, constant variable, or constant number
total energy	scalar variable
velocity	vector variable
ratio of specific heats	scalar variable, constant variable, or constant number

**Normalized Stagnation Enthalpy**

*EnthalpyNormStag* (any part(s), density, total energy, velocity, ratio of specific heats, freestream density, freestream speed of sound, freestream velocity magnitude)  
 Computes a scalar variable which is Normalized Stagnation Enthalpy  $h_{on}$  defined as:

$$h_{on} = h_o/h_{oi}$$

where:  $h_o$  = stagnation enthalpy  
 $h_{oi}$  = freestream stagnation enthalpy

density	scalar variable, constant variable, or constant number
total energy	scalar variable
velocity	vector variable
ratio of specific heats	scalar variable, constant variable, or constant number
freestream density	constant variable or constant number
freestream speed of sound	constant variable or constant number
freestream velocity magnitude	constant variable or constant number

**Entropy**

*Entropy* (any part(s), density, total energy, velocity, ratio of specific heats, gas constant, freestream density, freestream speed of sound)  
 Computes a scalar variable which is Entropy  $s$  defined as:

$$s = \ln \left( \frac{\frac{p}{\rho}}{\left(\frac{p_i}{\rho_i}\right)^\gamma} \right) \left( \frac{R}{\gamma - 1} \right)$$

where:  $R$  = gas constant  
 $\rho$  = density  
 $\rho_i$  = freestream density  
 $p$  = pressure  
 $p_i$  = freestream pressure =  $(\rho_i c_i^2)/\gamma$   
 $c_i$  = velocity magnitude  
 $\gamma$  = ratio of specific heats

density	scalar variable, constant variable, or constant number
total energy	scalar variable
velocity	vector variable
ratio of specific heats	scalar variable, constant variable, or constant number
gas constant	constant variable or constant number
freestream density	constant variable or constant number
freestream speed of sound	constant variable or constant number

**Flow**

*Flow* (any 1D or 2D part(s), velocity).

Computes a constant variable whose value is the flow  $Q_c$  defined as:

$$Q_c = \int_S V_n dS$$

where  $V_n$  = Velocity value normal to the surface  
 $S$  = 1D or 2D domain

velocity	vector variable
----------	-----------------

Note: Normal for a 1D part will be parallel to the plane of the plane tool

**Flow Rate**

*FlowRate* (any 1D or 2D part(s), velocity).

Computes a scalar variable  $Q$  defined as:

$$Q = V \cdot \hat{n}$$

where  $V$  = Velocity

$\hat{n}$  = Surface Normal

velocity	vector variable
----------	-----------------

**Fluid Shear**

*FluidShear*(2D part(s), velocity magnitude gradient, viscosity)

Computes a scalar variable tau whose value is defined as:

$$\text{tau} = \mu \frac{\partial V}{\partial n} \quad \text{where tau} = \text{shear stress}$$

$\mu$  = dynamic viscosity

$\frac{\partial V}{\partial n}$  = Velocity gradient in direction of surface normal

Hints: To compute fluid shear stress:

1. Use gradient function on velocity to obtain “Velocity Grad” variable in the 3D part(s) of interest.
2. Use clip option (through the 3D part(s) used in 1.) to obtain a surface on which you wish to see the fluid shear stress.
3. Compute Fluid Shear variable (on the 2D clip surface of 2.)

velocity gradient	vector variable
viscosity	scalar variable, constant variable, or constant number

**Fluid Shear Stress Max**

*FluidShearMax* (2D or 3D part(s), velocity, density, turbulent kinetic energy, turbulent dissipation, laminar viscosity)

Computes a scalar variable  $\Sigma$  defined as:

$$\Sigma = F/A = (u_t + u_l)E \quad \text{where } F = \text{force}$$

$A$  = unit area

$u_t$  = turbulent (eddy) viscosity

$u_l$  = laminar viscosity (treated as a constant)

$E$  = local strain

The turbulent viscosity  $u_t$  is defined as:

$$u_t = \frac{\rho 0.09 \kappa^2}{\varepsilon} \quad \text{where } \rho = \text{density}$$

$\kappa$  = turbulent kinetic energy

$\varepsilon$  = turbulent dissipation

A measure of local strain  $E$  (i.e. local elongation in 3 directions) is given by

$$E = \sqrt{2 \text{tr}(D \cdot D)} \quad \text{where}$$

$$2 \text{tr}(D \cdot D) = 2((d_{11})^2 + (d_{22})^2 + (d_{33})^2) + ((d_{12})^2 + (d_{13})^2 + (d_{23})^2)$$

given the *Euclidean norm* defined by

$$\text{tr}(D \cdot D) = (d_{11})^2 + (d_{22})^2 + (d_{33})^2 + \frac{1}{2}((d_{12})^2 + (d_{13})^2 + (d_{23})^2) ;$$

and the rate of deformation tensor  $d_{ij}$  defined by

$$D = [d_{ij}] = \frac{1}{2} \begin{bmatrix} 2d_{11} & d_{12} & d_{13} \\ d_{21} & 2d_{22} & d_{23} \\ d_{31} & d_{32} & 2d_{33} \end{bmatrix}$$

$$\begin{aligned} \text{with } d_{11} &= 'u/'x \\ d_{22} &= 'v/'y \\ d_{33} &= 'w/'z \\ d_{12} &= 'u/'y + 'v/'x = d_{21} \\ d_{13} &= 'u/'z + 'w/'x = d_{31} \\ d_{23} &= 'v/'z + 'w/'y = d_{32} \end{aligned}$$

given the strain tensor  $e_{ij}$  defined by  $e_{ij} = \frac{1}{2}d_{ij}$

velocity	vector variable
density	scalar variable, constant variable, or constant number
turbulent kinetic energy	scalar variable
turbulent dissipation	scalar variable
laminar viscosity	constant variable or constant number

**Force**

*Force*(2D part(s), pressure)

Computes a vector variable whose value is the force  $F$  defined as:

$$F = pA$$

where  $p$  = pressure  
 $A$  = unit area

Note: The force acts in the surface normal direction.

pressure	scalar variable
----------	-----------------

**Force 1D**

*Force1D*(1D planar part(s), pressure, surface normal)

Computes a vector variable whose value is the force  $F$  defined as:

$$F = pL$$

where  $p$  = pressure  
 $L$  = unit length times 1

Note: The force acts in the part's normal direction (in plane).

pressure	scalar variable
surface normal	vector variable

**Gradient**

*Grad* (2D or 3D part(s), scalar or vector(Magnitude will be used))

Computes a vector variable whose value is the gradient  $GRAD_f$  defined as:

$$GRAD_f = \frac{\partial f}{\partial x}i + \frac{\partial f}{\partial y}j + \frac{\partial f}{\partial z}k$$

where  $f$  = any scalar variable (or the magnitude of the specified vector)  
 $x, y, z$  = coordinate directions  
 $i, j, k$  = unit vectors in coordinate directions

**Gradient Approximation**

*GradApprox* (2D or 3D part(s), scalar or vector(Magnitude will be used))

Same as Gradient, except all elements are first subdivided into triangles (for 2D) or tetrahedrons (for 3D) and a closed-form solution is done on the subdivided element's nodal values (only applicable for per node variables). This is basically a quicker, linear approximation of the regular gradient.



**Gradient Tensor** *GradTensor* (2D or 3D part(s), vector)

Computes a tensor variable whose value is the gradient  $GRAD_F$  defined as:

$$GRAD_F = \frac{\partial F}{\partial x} \hat{i} + \frac{\partial F}{\partial y} \hat{j} + \frac{\partial F}{\partial z} \hat{k}$$

where  $F$  = any vector variable

$x, y, z$  = coordinate directions

$i, j, k$  = unit vectors in coordinate directions

**Gradient Tensor Approximation** *GradTensorApprox* (2D or 3D part(s), vector)

Same as Gradient Tensor, except all elements are first subdivided into triangles (for 2D) or tetrahedrons (for 3D) and a closed-form solution is done on the subdivided element's nodal values (only applicable for per node variables). This is basically a quicker, linear approximation of the regular gradient tensor.

### Helicity:

**Helicity Density** *HelicityDensity*(any part(s), velocity)

Computes a scalar variable  $H_d$  whose value is:

$$H_d = V \bullet \Omega$$

where:  $V$  = Velocity

$\Omega$  = Vorticity

velocity	vector variable
----------	-----------------

**Relative Helicity** *HelicityRelative*(any part(s), velocity)

Computes a scalar variable  $H_r$  whose value is:

$$H_r = \cos \phi = \frac{V \bullet \Omega}{|V||\Omega|}$$

where:  $\phi$  = the angle between the velocity vector and the vorticity vector.

velocity	vector variable
----------	-----------------

**Filtered Relative Helicity** *HelicityRelFilter*(any part(s), velocity, freestream velocity magnitude).

Computes a scalar variable  $H_{rf}$  whose value is:

$$H_{rf} = H_r, \text{ if } |H_d| \geq \text{filter}$$

$$\text{or } H_{rf} = 0, \text{ if } |H_d| < \text{filter}$$

where  $H_r$  = relative helicity (as described above)

$H_d$  = helicity density (as described above)

$$\text{filter} = 0.1(V_\infty)^2$$

velocity	vector variable
freestream velocity magnitude	constant variable or constant number

**Iblanking Values** *IblankingValues* (Any iblanked structured part(s))

Computes a scalar variable whose value is the iblanking flag of selected parts.

**Integrals:**

**Line Integral** *IntegralLine* (1D part(s), scalar or (vector, component))  
 Computes a constant variable whose value is the integral of the input variable over the length of the specified 1D part(s).

**Surface Integral** *IntegralSurface* (2D part(s), scalar or (vector, component))  
 Computes a constant variable whose value is the integral of the input variable over the surface of the specified 2D part(s).

**Volume Integral** *IntegralVolume* (3D part(s), scalar or (vector, component))  
 Computes a constant variable whose value is the integral of the input variable over the volume of the specified 3D part(s).

**Kinetic Energy** (See under Energy)

**Length** *Length* (any 1D part(s))  
 Computes a constant variable whose value is the length of selected parts. While any part can be specified, it will only return a nonzero length if the part has 1D elements.

*Line Integral* See Line Integral under **Integrals**.

**Mach Number** *Mach* (any part(s), density, total energy, velocity, ratio of specific heats)  
 Computes a scalar variable whose value is the Mach number M defined as:

$$M = \frac{u}{\sqrt{\frac{\gamma p}{\rho}}} = \frac{u}{c}$$

where m = momentum

$\rho$  = density

$u$  = speed, computed from velocity input.

$\gamma$  = ratio of specific heats (1.4 for air)

$p$  = pressure (see *Pressure* below)

$c$  = speed of sound

See [Total Energy](#) in this section for a description.

density	scalar variable, constant variable, or constant number
total energy	scalar variable
velocity	vector variable
ratio of specific heats	scalar variable, constant variable, or constant number

**Make Scalar at Elements** *MakeScalElem* (any part(s), constant number or constant variable)  
 Assigns the specified constant value to each element, making a scalar variable.

**Make Scalar at Nodes** *MakeScalNode* (any part(s), constant number or constant variable)  
 Assigns the specified constant value to each node, making a scalar variable.

**Make Vector** *MakeVect* (any part(s), scalar or zero, scalar or zero, scalar or zero)  
 Computes a vector variable formed from scalar variables. First scalar becomes the X component of the vector, second scalar becomes the Y component, and the third scalar becomes the Z component. A zero can be specified for some of the scalars, creating a 2D or 1D vector field.

**Massed Particle Scalar** *MassedParticle* (massed particle trace part(s))

This scalar creates a massed-particle per element scalar variable for each of the parent parts of the massed-particle traces. This per element variable is the mass of the particle times the sum of the number of times each element is exited by a mass-particle trace. See [Particle-Mass Scalar on Boundaries](#) in Chapter 7

**Mass-Flux Average***MassFluxAvg* (any 1D or 2D part(s), scalar, velocity, density)Computes a constant variable whose value is the mass flux average  $b_{avg}$  defined as:

$$b_{avg} = \frac{\oint_A \rho b (V \cdot N) dA}{\oint_A \rho (V \cdot N) dA} = \frac{\text{MassFluxOfScalar}}{\text{MassFlux}} = \frac{\text{Flow}(plist, b\rho V)}{\text{Flow}(plist, \rho V)}$$

where  $b$  = any scalar variable, i.e. pressure, mach, a vector component, etc.  
 $\rho$  = density (constant or scalar) variable  
 $V$  = velocity (vector) variable  
 $dA$  = area of some 2D domain  
 $N$  = unit vector normal to  $dA$

scalar	any scalar variable, i.e. pressure, mach, a vector component, etc
velocity	a vector variable
density	scalar variable, constant variable, or constant number

**Max***Max* (any part(s), scalar or (vector, component))

Computes a constant variable whose value is the maximum value of the scalar (or vector component) in the parts selected. The component is not requested if a scalar is selected.

[component]	if vector variable, magnitude is the default, or specify [x], [y], or [z]
-------------	---

**Min***Min* (any part(s), scalar or (vector, component))

Computes a constant variable whose value is the minimum value of the scalar (or vector component) in the parts selected.

[component]	if vector variable, magnitude is the default, or specify [x], [y], or [z]
-------------	---

**Moment***Moment* (any part(s), vector, component).Computes a constant variable (the moment about the cursor tool location) whose value is the  $x$ ,  $y$ , or  $z$  component of Moment  $M$ .

$$M_x = \Sigma(F_y d_z - F_z d_y)$$

$$M_y = \Sigma(F_z d_x - F_x d_z)$$

$$M_z = \Sigma(F_x d_y - F_y d_x)$$

where  $F_i$  = force vector component in direction  $i$  of vector  $F(x,y,z)$   
= (Fx,Fy,Fz)

$d_i$  = signed moment arm (the perpendicular distance from the line of action of the vector component  $F_i$  to the moment axis (which is the current cursor tool position)).

vector	any vector variable
component	[X], [Y], or [Z]

**MomentVector** *MomentVector* (any part(s), force vector).  
 Computes a vector variable (the moment is computed about each point of the selected parts) whose value is the  $x$ ,  $y$ , or  $z$  component of Moment  $M$ .

$$M_x = \Sigma(F_y d_z - F_z d_y)$$

$$M_y = \Sigma(F_z d_x - F_x d_z)$$

$$M_z = \Sigma(F_x d_y - F_y d_x)$$

where  $F_i$  = force vector component in direction  $i$  of vector  $F(x,y,z)$   
 $= (F_x, F_y, F_z)$   
 $d_i$  = signed moment arm (the perpendicular distance from the line of action of the vector component  $F_i$  to the moment axis (model point position)).

**Momentum** *Momentum* (any part(s), velocity, density).  
 Computes a vector variable  $m$ , which is:

$$m = \rho V$$

where  $\rho$  = density  
 $V$  = velocity

velocity	a vector variable
density	scalar variable, constant variable, or constant number

**Node to Element** *NodeToElem* (any part(s), node-based scalar or vector).  
 Averages a node based variable to produce an element based variable.

**Normal** *Normal* (2D part(s) or 1D planar part(s))  
 Computes a vector variable which is the normal to the surface at each node for 2D parts, or for 1D planar parts - lies normal to the 1D elements in the plane of the part.

**Normal Constraints** *NormC* (2D or 3D part(s), pressure, velocity, viscosity)  
 Computes a constant variable whose value is the Normal Constraints  $NC$  defined as:

$$NC = \int_S \left( -p + \mu \frac{\partial V_n}{\partial n} \right) dS$$

where  $p$  = pressure  
 $V$  = velocity  
 $\mu$  = dynamic viscosity  
 $n$  = direction of normal  
 $S$  = border of a 2D or 3D domain

pressure	scalar variable
velocity	vector variable
viscosity	scalar variable, constant variable, or constant number

**Normalize Vector** *NormVect* (any part(s), vector)  
 Computes a vector variable whose value is a unit vector  $U$  of the given vector  $V$ .

$$U = \frac{V(V_x, V_y, V_z)}{\|V\|}$$

where:  $V$  = vector variable field

$$\|V\| = \sqrt{V_x^2 + V_y^2 + V_z^2}$$

**Offset Field**      *OffsetField* (2D or 3D part(s))  
 Computes a scalar field of offset values. The values will be in model distance units perpendicular to the boundary of the part. Note that an isosurface created in this field would mimic the part boundary, but at the offset distance into the field.

**Offset Variable**      *OffsetVar*(2D or 3D part(s), scalar or vector, constant offset value)  
 Computes a scalar (or vector) variable defined as the offset value into the field of that variable that exists in the normal direction from the boundary of the part.

constant offset value	constant number (constant variable is not valid)
-----------------------	--

**Pressure**      *Pres* (any part(s), density, total energy, velocity, ratio of specific heats)  
 Computes a scalar variable whose value is the pressure  $p$  defined as:

$$p = (\gamma - 1)\rho\left(\frac{E}{\rho} - \frac{1}{2}V^2\right)$$

where:       $m$  = momentum  
                $E$  = internal energy  
                $\rho$  = density  
                $V$  = velocity =  $m/\rho$   
                $\gamma$  = ratio of specific heats (1.4 for air)

density	scalar variable, constant variable, or constant number
total energy	scalar variable
velocity	vector variable
ratio of specific heats	scalar variable, constant variable, or constant number

**Pressure Coefficient**      *PresCoef* (any part(s), density, total energy, velocity, ratio of specific heats, freestream density, freestream speed of sound, freestream velocity magnitude)  
 Computes a scalar variable which is Pressure Coefficient  $C_p$  defined as:

$$C_p = \frac{p - p_i}{\frac{\rho_i V_i^2}{2}}$$

where:       $p$  = pressure  
                $p_i$  = freestream pressure  
                $\rho_i$  = freestream density  
                $V_i$  = freestream velocity magnitude

density	scalar variable, constant variable, or constant number
total energy	scalar variable
velocity	vector variable
ratio of specific heats	scalar variable, constant variable, or constant number
freestream density	constant variable or constant number
freestream speed of sound	constant variable or constant number
freestream velocity magnitude	constant variable or constant number

**Dynamic Pressure**

*PresDynam* (any part(s), density, velocity)

Computes a scalar variable which is Dynamic Pressure  $q$  defined as:

$$q = \frac{\rho V^2}{2}$$

where:  $\rho$  = density  
 $V$  = velocity magnitude

See also: Kinetic Energy

density	scalar variable, constant variable, or constant number
velocity	vector variable

**Normalized Pressure**

*PresNorm* (any part(s), density, total energy, velocity, ratio of specific heats, freestream density, freestream speed of sound)

Computes a scalar variable which is Normalized Pressure  $p_n$  defined as:

$$p_n = p/p_i$$

where:  $p_i$  = freestream pressure =  $1/\gamma$   
 $\gamma$  = ratio of specific heats  
 $p$  = pressure

density	scalar variable, constant variable, or constant number
total energy	scalar variable
velocity	vector variable
ratio of specific heats	scalar variable, constant variable, or constant number
freestream density	constant variable or constant number
freestream speed of sound	constant variable or constant number

**Log of Normalized Pressure**

*PresLogNorm* (any part(s), density, total energy, velocity, ratio of specific heats, freestream density, freestream speed of sound)

Computes a scalar variable which is the natural log of Normalized Pressure defined as:  $\ln p_n = \ln(p/p_i)$

where:  $p_i$  = freestream pressure =  $1/\gamma$   
 $\gamma$  =ratio of specific heats  
 $p$  = pressure

density	scalar variable, constant variable, or constant number
total energy	scalar variable
velocity	vector variable
ratio of specific heats	scalar variable, constant variable, or constant number
freestream density	constant variable or constant number
freestream speed of sound	constant variable or constant number

**Stagnation Pressure***PresStag* (any part(s), density, total energy, velocity, ratio of specific heats)Computes a scalar variable which is the Stagnation Pressure  $p_o$  defined as:

$$p_o = p \left( 1 + \left( \frac{\gamma - 1}{2} \right) M^2 \right)^{\gamma / (\gamma - 1)}$$

where:  $p$  = pressure $\gamma$  = ratio of specific heats $M$  = mach number

density	scalar variable, constant variable, or constant number
total energy	scalar variable
velocity	vector variable
ratio of specific heats	scalar variable, constant variable, or constant number

**Normalized Stagnation Pressure***PresNormStag* (any part(s), density, total energy, velocity, ratio of specific heats, freestream density, freestream speed of sound, freestream velocity magnitude)Computes a scalar variable which is Normalized Stagnation Pressure  $p_{on}$ 

$$\text{defined as: } p_{on} = p_o / p_{oi}$$

where:  $p_o$  = stagnation pressure $p_{oi}$  = freestream stagnation pressure

density	scalar variable, constant variable, or constant number
total energy	scalar variable
velocity	vector variable
ratio of specific heats	scalar variable, constant variable, or constant number
freestream density	constant variable or constant number
freestream speed of sound	constant variable or constant number
freestream velocity magnitude	constant variable or constant number

**Stagnation Pressure Coefficient***PresStagCoef* (any part(s), density, total energy, velocity, ratio of

specific heats, freestream density, freestream speed of sound, freestream velocity magnitude)

Computes a scalar variable which is Stagnation Pressure Coefficient  $C_{p_o}$ 

$$\text{defined as: } C_{p_o} = (p_o - p_i) / \left( \frac{\rho_i V^2}{2} \right)$$

where:  $p_o$  = stagnation pressure $p_i$  = freestream pressure =  $1/\gamma$  $\gamma$  = ratio of specific heats $\rho_i$  = freestream density $V$  = velocity magnitude

density	scalar variable, constant variable, or constant number
total energy	scalar variable
velocity	vector variable
ratio of specific heats	scalar variable, constant variable, or constant number
freestream density	constant variable or constant number
freestream speed of sound	constant variable or constant number
freestream velocity magnitude	constant variable or constant number

**Pitot Pressure**

*PresPitot* (any part(s), density, total energy, velocity, ratio of specific heats)  
 Computes a scalar variable which is Pitot Pressure  $p_p$  defined as:

$$p_p = sp$$

$$s = \frac{\left( \left( \frac{\gamma+1}{2} \right) \left( \frac{V^2}{\gamma(\gamma-1) \left( \frac{E}{\rho} - \frac{V^2}{2} \right)} \right) \right)^{\gamma/(\gamma-1)}}{\left( \left( \frac{2\gamma}{\gamma+1} \right) \left( \frac{V^2}{\gamma(\gamma-1) \left( \frac{E}{\rho} - \frac{V^2}{2} \right)} \right) - \frac{\gamma-1}{\gamma+1} \right)^{1/(\gamma-1)}}$$

where  $\gamma$  = ratio of specific heats  
 E = total energy per unit volume  
 $\rho$  = density  
 V = velocity magnitude  
 p = pressure

density	scalar variable, constant variable, or constant number
total energy	scalar variable
velocity	vector variable
ratio of specific heats	scalar variable, constant variable, or constant number

*Note:* For mach numbers less than 1.0, the Pitot Pressure is the same as the Stagnation Pressure. For mach numbers greater than or equal to 1.0, the Pitot Pressure is equivalent to the Stagnation Pressure behind a normal shock.

**Pitot Pressure Ratio**

*PresPitotRatio* (any part(s), density, total energy, velocity, ratio of specific heats, freestream density, freestream speed of sound)  
 Computes a scalar variable which is Pitot Pressure Ratio  $p_{pr}$  defined as:

$$p_{pr} = s(\gamma-1) \left( E - \frac{\rho V^2}{2} \right)$$

where  $s$  = (defined above in Pitot Pressure)  
 $\gamma$  = ratio of specific heats  
 E = total energy per unit volume  
 $\rho$  = density  
 V = velocity magnitude

density	scalar variable, constant variable, or constant number
total energy	scalar variable
velocity	vector variable
ratio of specific heats	scalar variable, constant variable, or constant number
freestream density	constant variable or constant number
freestream speed of sound	constant variable or constant number



**Total Pressure** *PresT* (any part(s), pressure, velocity, density)  
 Computes a scalar variable whose value is the total pressure  $p_t$  defined as:

$$p_t = p + \rho \left( \frac{V^2}{2} \right)$$

where  $\rho$  = density  
 $V$  = velocity  
 $p$  = pressure

pressure	scalar variable
velocity	vector variable
density	scalar variable, constant variable, or constant number

**Rectangular To Cylindrical Vector** *RectToCyl* (any part(s), vector)  
 Produces a vector variable with cylindrical components according to frame 0.  
 (Intended for calculation purposes)  
 $x$  = radial component,  $y$  = tangential component,  $z$  = z component

**Shock Plot3d** *ShockPlot3d* (2D or 3D part(s), density, total energy, velocity, ratio of specific heats).  
 computes a scalar variable *ShockPlot3d*, whose value is:

$$ShockPlot3d = \frac{V}{c} \cdot \frac{grad(p)}{|grad(p)|}$$

where  $V$  = velocity  
 $c$  = speed of sound  
 $p$  = pressure  
 $grad(p)$  = gradient of pressure

density	scalar variable, constant variable, or constant number
total energy	scalar variable
velocity	vector variable
ratio of specific heats	scalar variable, constant variable, or constant number

**Spatial Mean** *SpaMean* (any part(s), scalar or (vector, component))

Computes a constant variable whose value is the volume (or area) weighted mean value of a scalar (or vector component) at the current time. This value can change with time. The component is not requested if a scalar variable is used

The spatial mean is computed by summing the product of the volume (3D, or area 2D) of each element by the value of the scalar (or vector component) taken at the centroid of the element, for each element over the entire part. The final sum is then divided by the total volume (or area) of the part.

$$SpatialMean = \frac{\sum s_i vol_i}{\sum vol_i}$$

where:  $s_i$  = Scalar taken at centroid of element  $i$   
 $vol_i$  = Volume (or Area) of element  $i$

[component]	if vector variable, magnitude is the default, or specify [x], [y], or [z]
-------------	---

**Speed***Speed* (any part(s), velocity)

Computes a scalar variable whose value is the Speed defined as:

$$Speed = \sqrt{u^2 + v^2 + w^2}$$

where:  $u, v, w$  = velocity components in the x,y,z directions.

velocity	vector variable
----------	-----------------

**Sonic Speed***SonicSpeed*(any part(s), density, total energy, velocity, ratio of specific heats).Computes a scalar variable  $c$ , whose value is:

$$c = \sqrt{\frac{\gamma p}{\rho}}$$

where  $\gamma$  = ratio of specific heats $\rho$  = density $p$  = pressure

density	scalar variable, constant variable, or constant number
total energy	scalar variable
velocity	vector variable
ratio of specific heats	scalar variable, constant variable, or constant number

**Stream Function** *Stream* (any 2D part(s), velocity, density)Computes a scalar variable whose value is the Stream Function  $\Psi$  defined as:

$$d\psi = -\rho v dx + \rho u dy$$

where:  $u, v$  = velocity components in X, Y directions $\rho$  = density

velocity	vector variable
density	scalar variable, constant variable, or constant number

**Surface Integral**See Surface Integral under **Integrals**.

Computes a constant variable whose value is the integral of the input variable over the surface of the specified 2D part(s).

**Swirl***Swirl* (any part(s), density, velocity).Computes a scalar variable *Swirl*, whose value is:

$$Swirl = \frac{\Omega \cdot V}{\rho V^2}$$

where:  $\Omega$  = vorticity $\rho$  = density $V$  = velocity

density	scalar variable, constant variable, or constant number
velocity	vector variable

**Temperature** *Temper* (any part(s), density, total energy, velocity, ratio of specific heats, gas constant)

Computes a scalar variable whose value is the temperature  $T$  defined as:

$$T = \frac{\gamma - 1}{R} \left( \frac{E}{\rho} - \frac{1}{2} V^2 \right)$$

where:  $m$  = momentum  
 $E$  = total energy per unit volume  
 $\rho$  = density  
 $V$  = velocity =  $m/\rho$   
 $\gamma$  = ratio of specific heats (1.4 for air)  
 $R$  = gas constant

density	scalar variable, constant variable, or constant number
total energy	scalar variable
velocity	vector variable
ratio of specific heats	scalar variable, constant variable, or constant number
gas constant	constant variable or constant number

**Normalized Temperature** *TemperNorm* (any part(s), density, total energy, velocity, ratio of specific heats, freestream density, freestream speed of sound, gas constant)

Computes a scalar variable which is Normalized Temperature  $T_n$  defined as:

$$T_n = \frac{T}{T_i}$$

where:  $T$  = temperature  
 $T_i$  = freestream temperature

density	scalar variable, constant variable, or constant number
total energy	scalar variable
velocity	vector variable
ratio of specific heats	scalar variable, constant variable, or constant number
freestream density	constant variable or constant number
freestream speed of sound	constant variable or constant number
gas constant	constant variable or constant number

**Log of Normalized Temperature** *TemperLogNorm* (any part(s), density, total energy, velocity, ratio of specific heats, freestream density, freestream speed of sound, gas constant)  
 Computes a scalar variable which is the natural log of Normalized Temperature

defined as:  $\ln T_n = \ln(T/T_i)$

where:  $T$  = temperature  
 $T_i$  = freestream temperature

density	scalar variable, constant variable, or constant number
total energy	scalar variable
velocity	vector variable
ratio of specific heats	scalar variable, constant variable, or constant number
freestream density	constant variable or constant number
freestream speed of sound	constant variable or constant number
gas constant	constant variable or constant number

### 4.3 Variable Creation

**Stagnation Temperature** *TemperStag* (any part(s), density, total energy, velocity, ratio of specific heats, gas constant)  
 Computes a scalar variable which is the Stagnation Temperature  $T_o$

$$\text{defined as: } T_o = T \left( 1 + \left( \frac{\gamma - 1}{2} \right) M^2 \right)$$

where:  $T$  = temperature  
 $\gamma$  = ratio of specific heats  
 $M$  = mach number

density	scalar variable, constant variable, or constant number
total energy	scalar variable
velocity	vector variable
ratio of specific heats	scalar variable, constant variable, or constant number
gas constant	constant variable or constant number

**Normalized Stagnation Temperature** *TemperNormStag* (any part(s), density, total energy, velocity, ratio of specific heats, freestream density, freestream speed of sound, freestream velocity magnitude, gas constant)  
 Computes a scalar variable which is Normalized Stagnation Temperature  $T_{on}$

$$\text{defined as: } T_{on} = T_o / T_{oi}$$

where:  $T_o$  = stagnation temperature  
 $T_{oi}$  = freestream stagnation temperature

density	scalar variable, constant variable, or constant number
total energy	scalar variable
velocity	vector variable
ratio of specific heats	scalar variable, constant variable, or constant number
freestream density	constant variable or constant number
freestream speed of sound	constant variable or constant number
freestream velocity magnitude	constant variable or constant number
gas constant	constant variable or constant number

**Temporal Mean** *TempMean* (any part(s), scalar or vector, timestep1, timestep2)  
 Computes a scalar or vector variable, depending on which type was selected, whose value is the mean value at each node of a scalar or vector variable over the interval from timestep1 to timestep2. Thus, the resultant scalar or vector is independent of time.

timestep1	constant number
timestep2	constant number

#### Tensor:

**Tensor Component** *TensorComponent* (any part(s), tensor, tensor row(1-3), tensor col(1-3))  
 Creates a scalar variable which is the specified row and column of a tensor variable.

$S = T_{ij}$   
 $i$  = given row (1 to 3)  
 $j$  = given column (1 to 3)

tensor row	constant number (1 to 3)
tensor col	constant number (1 to 3)

<b>Tensor</b> Determinate	<i>TensorDeterminant</i> (any part(s), Tensor or 3 Principals or 6 Tensor Components) Computes the determinate of a tensor variable. The tensor may be specified as either a tensor, three principal values or six tensor components. If the three tensor components are given they must be given in the order: T11, T22, T33, T12, T13, T23.
<b>Tensor</b> Eigenvalue	<i>TensorEigenvalue</i> (any part(s), tensor, which number(1-3)) Computes the number (1-3) eigenvalue of the given tensor. The first eigenvalue is always the largest, while the third eigenvalue is always the smallest.
<b>Tensor</b> Eigenvector	<i>TensorEigenvector</i> (any part(s), tensor, which number(1-3)) Computes the number (1-3) eigenvector of the given tensor.
<b>Tensor</b> Make	<i>TensorMake</i> (any part(s), T11, T22, T33, T12, T13, T23) Create a tensor from six scalars.
<b>Tensor</b> Make Asymmetric	<i>TensorMakeAsym</i> (any part(s), T11, T12, T13, T21, T22, T23, T31, T32, T33) Create a tensor from 9 scalars.
<b>Tensor</b> Tresca	<i>TensorTresca</i> (any part(s), Tensor or 3 Principals or 6 Tensor Components) Computes Tresca stress/strain from a tensor variable. The tensor may be specified as either a tensor, three principal values or six tensor components. If the three tensor components are given they must be given in the order: T11, T22, T33, T12, T13, T23.

$$\sigma_{yp} = |\sigma_1 - \sigma_3|$$

where:  $\sigma_{yp}$  = yield stress

$\sigma_1$  = greatest principal stress/strain

$\sigma_3$  = least principal stress/strain

<b>Tensor</b> Von Mises	<i>TensorVonMises</i> (any part(s), Tensor or 3 Principals or 6 Tensor Components) Computes Von Mises stress/strain from a tensor variable. The tensor may be specified as either a tensor, three principal values or six tensor components. If the three tensor components are given they must be given in the order: T11, T22, T33, T12, T13, T23.
----------------------------	--

$$\sigma_{yp} = \sqrt{(\sigma_1 - \sigma_2)^2 + (\sigma_2 - \sigma_3)^2 + (\sigma_3 - \sigma_1)^2}$$

where:  $\sigma_{yp}$  = yield stress

$\sigma_1$  = greatest principal stress/strain

$\sigma_2$  = middle principal stress/strain

$\sigma_3$  = least principal stress/strain

<b>Velocity</b>	<i>Velo</i> (any part(s), momentum, density) Computes a vector variable whose value is the velocity V defined as:
-----------------	--

$$V = \frac{m}{\rho}$$

where  $\rho$  = density

$m$  = momentum

momentum	vector variable
density	scalar variable, constant variable, or constant number

### 4.3 Variable Creation

**Volume** *Vol* (3D part(s))  
Computes a constant variable whose value is the volume of 3D parts.

*Volume Integral* See Volume Integral under **Integrals**.

**Vorticity** *Vort* (any 2D or 3D part(s), velocity)  
Computes a vector variable with components  $\zeta_x$ ,  $\zeta_y$ ,  $\zeta_z$  defined as:

$$\zeta_x = \frac{\partial w}{\partial y} - \frac{\partial v}{\partial z} \quad \zeta_y = \frac{\partial u}{\partial z} - \frac{\partial w}{\partial x} \quad \zeta_z = \frac{\partial v}{\partial x} - \frac{\partial u}{\partial y}$$

where  $u, v, w$  = velocity components in the X, Y, Z directions.

velocity	vector variable
----------	-----------------

## Math

Math functions use the syntax: function (value *or* expression). All angle arguments are in radians. For most functions the value can be either a constant, scalar, or vector and the result of the function will be of corresponding type. When you select a math function from the list, the function name and the opening “(“ appears in the Working Expression for you. However, after defining the argument(s) for the function, you have to manually provide any commas needed and a closing “)”. The Math functions include:

<b>Routines which accept argument(s) of type constant, scalar, or vector and produce the corresponding type of result: (function works on each component of a vector)</b>	
<b>ABS</b> (constant) <b>absolute value</b> = constant <i>or</i> (scalar) scalar <i>or</i> (vector) vector	<b>ACOS</b> (constant) <b>arccosine</b> = radian constant <i>or</i> (scalar) radian scalar <i>or</i> (vector) radian vector
<b>ASIN</b> (constant) <b>arcsine</b> = radian constant <i>or</i> (scalar) radian scalar <i>or</i> (vector) radian vector	<b>ATAN</b> (constant) <b>arctangent</b> = radian constant <i>or</i> (scalar) radian scalar <i>or</i> (vector) radian vector
<b>ATAN2</b> (y, x) calculates <b>ATAN</b> (y/x) where the signs of both variables are used to determine the quadrant of the result. Returns the result in radians which is between -PI and PI (inclusive). So: <b>ATAN2</b> (constant, constant) = radian constant <i>or</i> (constant, scalar) = radian scalar <i>or</i> (constant, vector) = radian vector <i>or</i> (scalar, scalar) = radian scalar <i>or</i> (scalar, vector) = radian vector <i>or</i> (vector, vector) = radian vector where: $ATAN2(\text{vector1}, \text{vector2}) = (ATAN2(\text{vector1x}/\text{vector2x}), ATAN2(\text{vector1y}/\text{vector2y}), ATAN2(\text{vector1z}/\text{vector2z}))$	
<b>COS</b> (radian constant) <b>cosine</b> = constant <i>or</i> (radian scalar) scalar <i>or</i> (radian vector) vector	<b>CROSS</b> (vector, vector) <b>cross product</b> = vector
<b>DOT</b> (vector, vector) <b>dot product</b> = scalar	<b>EXP</b> (constant) <b>e value</b> = constant <i>or</i> (scalar) scalar <i>or</i> (vector) vector
<b>GT</b> (constant, constant) <b>greater of</b> = constant <i>or</i> (constant, scalar) scalar <i>or</i> (constant, vector) vector <i>or</i> (scalar, scalar) scalar <i>or</i> (scalar, vector) vector <i>or</i> (vector, vector) vector where: $GT(\text{vector1}, \text{vector2}) = (GT(\text{vector1x}, \text{vector2x}), GT(\text{vector1y}, \text{vector2y}), GT(\text{vector1z}, \text{vector2z}))$	
<b>LOG</b> (constant) <b>ln</b> = constant <i>or</i> (scalar) scalar <i>or</i> (vector) vector	<b>LOG10</b> (constant) <b>log<sub>10</sub></b> = constant <i>or</i> (scalar) scalar <i>or</i> (vector) vector
<b>LT</b> (constant, constant) <b>lesser of</b> = constant <i>or</i> (constant, scalar) scalar <i>or</i> (constant, vector) vector <i>or</i> (scalar, scalar) scalar <i>or</i> (scalar, vector) vector <i>or</i> (vector, vector) vector where: $LT(\text{vector1}, \text{vector2}) = (LT(\text{vector1x}, \text{vector2x}), LT(\text{vector1y}, \text{vector2y}), LT(\text{vector1z}, \text{vector2z}))$	
<b>RMS</b> (vector) <b>root-mean-square</b> (magnitude) = scalar	<b>RND</b> (constant) <b>round to nearest</b> = constant <i>or</i> (scalar) scalar <i>or</i> (vector) vector
<b>SIN</b> (radian constant) <b>sine</b> = constant <i>or</i> (radian scalar) scalar <i>or</i> (radian vector) vector	<b>SQRT</b> (constant) <b>square root</b> = constant <i>or</i> (scalar) scalar <i>or</i> (vector) vector
<b>TAN</b> (radian constant) <b>tangent</b> = constant <i>or</i> (radian scalar) scalar <i>or</i> (radian vector) vector	

### 4.3 Variable Creation

Active Variables	Selection list of all variables which are active and therefore available for use in Expressions. You activate variables in the Feature Detail Editor Variables List.																																		
Feedback	This area displays interactive guidance when you select a General function, including detailed instructions concerning the function's arguments.																																		
Okay	Click this button when so prompted by the Feedback instructions. It basically signals the completion of various intermediate tasks for general functions.																																		
<i>Calculator</i>	<p>This on-screen calculator can usually be used in place of typing on your keyboard.</p> <table><thead><tr><th><u>Button</u></th><th><u>Function</u></th></tr></thead><tbody><tr><td>0 to 9</td><td>number digits</td></tr><tr><td>.</td><td>decimal</td></tr><tr><td>e</td><td>e for exponential notation</td></tr><tr><td>+</td><td>plus operator</td></tr><tr><td>-</td><td>minus operator</td></tr><tr><td>*</td><td>multiplication operator</td></tr><tr><td>/</td><td>division operator</td></tr><tr><td>^</td><td>exponentiation operator</td></tr><tr><td>PI</td><td>value for <math>\pi</math></td></tr><tr><td>(</td><td>opening parentheses. For function arguments and general grouping</td></tr><tr><td>)</td><td>closing parentheses. For function arguments and general grouping</td></tr><tr><td>[</td><td>opening brackets. For components and node/element numbers</td></tr><tr><td>]</td><td>closing brackets. For components and node/element numbers</td></tr><tr><td>[X]</td><td>X component</td></tr><tr><td>[Y]</td><td>Y component</td></tr><tr><td>[Z]</td><td>Z component</td></tr></tbody></table> <p>(see <a href="#">How To Create New Variables</a>)</p>	<u>Button</u>	<u>Function</u>	0 to 9	number digits	.	decimal	e	e for exponential notation	+	plus operator	-	minus operator	*	multiplication operator	/	division operator	^	exponentiation operator	PI	value for $\pi$	(	opening parentheses. For function arguments and general grouping	)	closing parentheses. For function arguments and general grouping	[	opening brackets. For components and node/element numbers	]	closing brackets. For components and node/element numbers	[X]	X component	[Y]	Y component	[Z]	Z component
<u>Button</u>	<u>Function</u>																																		
0 to 9	number digits																																		
.	decimal																																		
e	e for exponential notation																																		
+	plus operator																																		
-	minus operator																																		
*	multiplication operator																																		
/	division operator																																		
^	exponentiation operator																																		
PI	value for $\pi$																																		
(	opening parentheses. For function arguments and general grouping																																		
)	closing parentheses. For function arguments and general grouping																																		
[	opening brackets. For components and node/element numbers																																		
]	closing brackets. For components and node/element numbers																																		
[X]	X component																																		
[Y]	Y component																																		
[Z]	Z component																																		



# 5 GUI Overview

The Graphical User Interface for EnSight 8 has undergone a number of improvements. These changes are not revolutionary in nature as compared to the EnSight 7 interface, but are refinements intended to increase, even more, the ease of use of EnSight. For example, more distinctive icons have been added, the part list has been improved, better tabs and controls have been implemented for various operations. In addition, more useful defaults are available for a number of features. Our experience has shown that current users of EnSight 7 have no difficulty in transitioning to EnSight 8.

The purpose of this Chapter is to provide a brief overview of the EnSight 8 GUI.

“Desktop” - refers to the upper level of the GUI. It contains the following areas:



Figure 5-1  
EnSight 8 Start-Up GUI

When EnSight first comes up, the Graphical User Interface should appear approximately as shown. The different sections of the GUI are used for specific purposes.

## Main Menu

In addition to providing access to high-level features such as Command File Creation/Editing/Reading, Results Data Reading, File Printing, Saving/Restoring a session, and Quitting, the Main Menu provides access to often-used postprocessing features such as editing, querying variable data, part appearance adjustment, and tool visibility.

Chapter 6 contains a complete description of each section of the Main Menu. (see [Chapter 6, Main Menu](#))

**Main Parts List Default** The Default Main Parts List contains the number and names of all parts that have been read in from your results data (model parts) or created within EnSight (created parts) nested within their Case description.

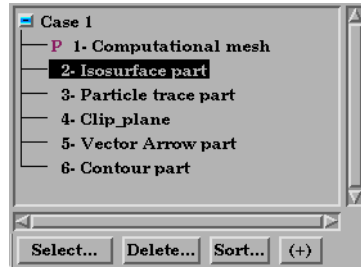

Figure 3-2  
Abbreviated Parts List

**Main Parts List Abbrev** Shown below is the Main Parts List Window if you click on the Sort Button pulldown, toggle “Show abbreviated details”. Notice that the Part List will contain more information. Displayed are a Part ID Number, Part Visibility, a Part symbol, the Part Representation, a Case number, and a Part name.

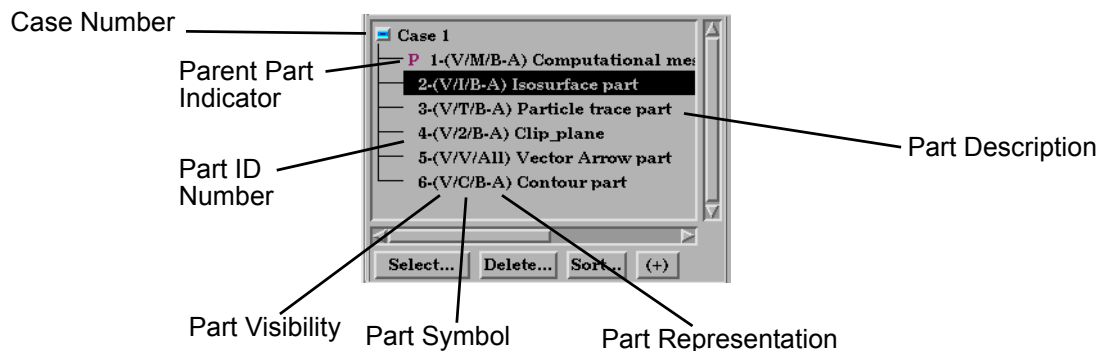

Figure 3-3  
Abbreviated Parts List

You will find sub-sets of this Main Parts List in the Feature Detail Editor for each type of part. For example, the Feature Detail Editor (Isosurface) will contain a parts list of only isosurface parts.

For a complete description of the Main Parts List as well as a detailed discussion about Part selection, editing, and operations thereon: (see [Section 3.1, Part Overview](#))

## Feature Icon Bar

This Icon Bar provides rapid access to things such as new part creation, 2D plot creation, data querying, time step control, flipbook animation and keyframe animation. Clicking once on an icon opens its associated editor in the Quick

Interaction Area.

Double clicking on a new part creation Icon (contours, isosurfaces, particle traces, clips, vector arrows, elevated surfaces, profiles, developed surfaces) will open the Feature Detail Editor for that type of created part.

Chapter 7 contains a detailed explanation of the features in the Quick Interaction Area which are available through each of the Icons.

(see [Chapter 7, Features](#))

#### Mode Selection Area

The Mode Selection Area contains four to five buttons which allow you to choose which of the “Modes” you wish to work in. The Mode selected will not only determine which icons you see in the Mode Icon Bar but also the way in which you work within the Graphics Window, The five possible Modes are:

- **Part Mode** for the specification of attributes for specific parts
- **Annot Mode** for the addition and editing of annotation lines, text, and logos to the Graphics window as well as the editing of Variable legends
- **Plot Mode** for the creation and specification of attributes for 2D Variable plots
- **VPort Mode** for the creation and control of additional viewports within the Graphics Window
- **Frame Mode** for the creation and specification of attributes for additional frames of reference within EnSight. *By default this mode is not displayed. If needed, this mode can be turned on under Edit > Preferences... General User Interface - Frame Mode Allowed.*

Chapter 8 contains a detailed explanation of the features available and the differences between the five modes.

(see [Chapter 8, Modes](#))

#### Mode Icon Bar

The vast majority of editing features available in EnSight are divided into five different groups and are accessible through the Mode Icon Bar. The set of Icons you see at any time are determined by which Mode has been selected in the Mode Selection Area.

The various Mode Icon Bars can be customized by the user:

See Preferences... in [Section 6.2, Edit Menu Functions](#))

Chapter 8 contains a detailed explanation of the features available and the differences between the five modes.

(see [Chapter 8, Modes](#))

#### Transformation Area

This area determines how you will transform Parts within the Graphics Window and also provides quick access to the Transformations Editor for precise control of transformations. Buttons are available for quick viewing down any of the major axes, for Storing/Recalling views and for undoing the last transformation.

Chapter 9 contains a detailed description of the features in the Transformation Area.

(see [Chapter 9, Transformation Control](#))

#### Message Area

This area provides feedback on what EnSight is doing. If you are using Transient data, this area will indicate which time step is currently in use.

Information Area Button	This button will bring up a dialog which will display any output that EnSight generates. When no new information is in the area, the button will be the typical interface color. When new information has been placed in the area, the button will be green in color. If warning information has been placed in the area, it will be yellow in color. If error information has been placed in the area, it will be red in color.
Quick Interaction Area	This area provides quick access to the features associated with each of the Icons in the Feature Icon Bar.  Chapter 7 contains a detailed explanation of the features in the Quick Interaction Area which are available through each of the Icons. (see <a href="#">Chapter 7, Features</a> )
Quick Desktop Buttons	This area contains some very commonly used toggles, such as the shading and tools.
Graphics Window	This area shows the model using the current display attributes. You perform all interactive transformations in the Graphics Window.
Tool Tips Toggle	This toggles on/off the Tool Tips (balloon help) for most icons. This option is useful for new users, but it is on the Desktop so experienced users can easily turn it off. (It's state is a part of the user's preferences - so it is remembered from session to session.). Not available in Windows, as Tool Tips are always on.

## GUI Conventions

The EnSight graphical user interface (GUI) uses the OSF/Motif toolkit for menus, dialogs, buttons, and other interface components. This section provides Motif specific information, as well as a quick introduction to some of the features of EnSight interface components.

### *Motif Window Manager*

The Motif Window Manager (mwm) is commonly used on workstations supporting Motif. Its use is recommended with EnSight. Although not required, the following values for mwm resources are strongly recommended:

```
Mwm*focusAutoRaise: false
Mwm*keyboardFocusPolicy: pointer
```

Without the first setting, windows may raise automatically when the mouse is moved into a window (which is very distracting). The second setting causes windows to be active (accept input) when the cursor is in the window, even if the window is partially obscured or has not been selected. These and other mwm resources are set in the appropriate X session resource file. See a local X Windows expert if you don't know where this file resides. See the references at the end of this chapter for more information on Motif, mwm, and X Windows.

*NOTE:* *The resources above prefixed with Mwm are specific to the Motif Window Manager. If you are using a different window manager consult your Systems Administrator for the equivalent settings. For instance, EnSight has been tested and performs as described herein on the 4Dwm and CDE window managers.*

### *Interface Components*

The EnSight GUI uses menus and dialogs that utilize and expand upon established OSF/Motif conventions. This section provides some general information on the operation of EnSight dialogs, menus, lists, buttons, and text fields.

### Dialogs

A dialog is a window that groups interface components based on function. Dialogs are typically opened by making selections from a menu. Menu selections that open dialogs always end with "...". Most EnSight dialogs can be opened and closed independently. In order to optimize scarce workstation screen real estate, you should close dialogs that are not in use.

Dialogs typically consist of buttons, menus, lists, and areas to type in. Many EnSight dialogs also have expandable sections that let you hide parts of the interface that you use infrequently. Each expandable section consists of an indicator button, a section title, and the contents of the section. The indicator button and the section title are always visible. If the section is open, the contents are visible as well.

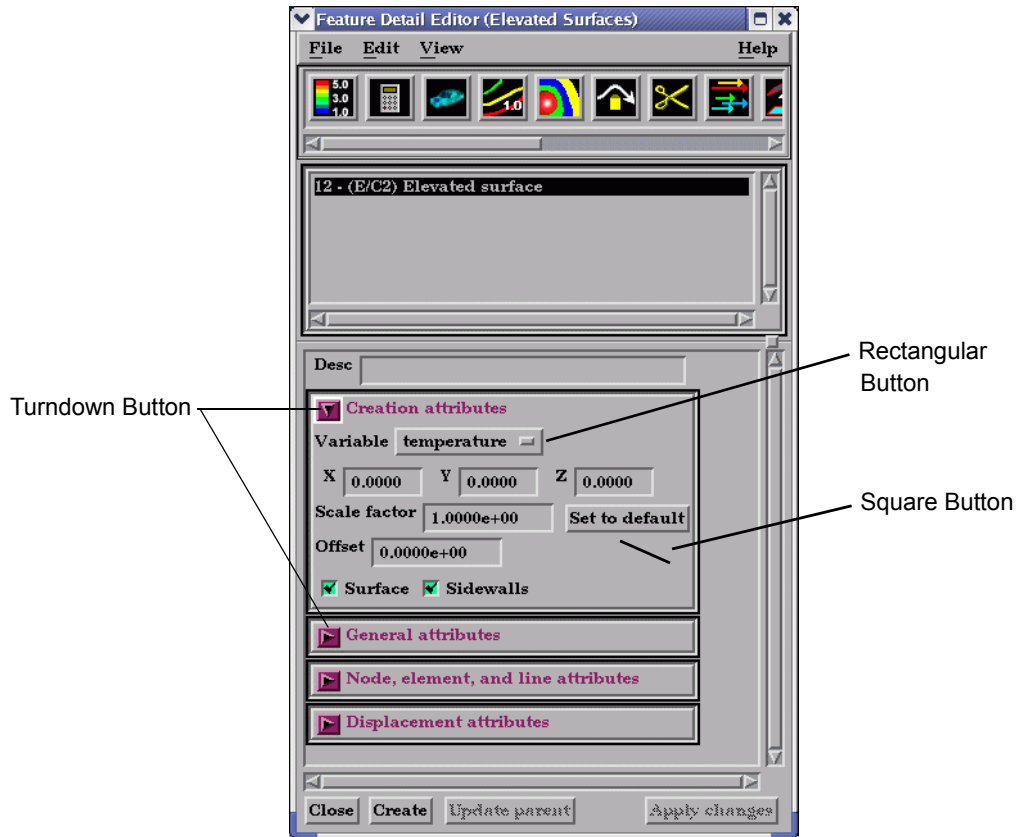

Menus

The EnSight documentation uses the following terms to describe various types of menus.

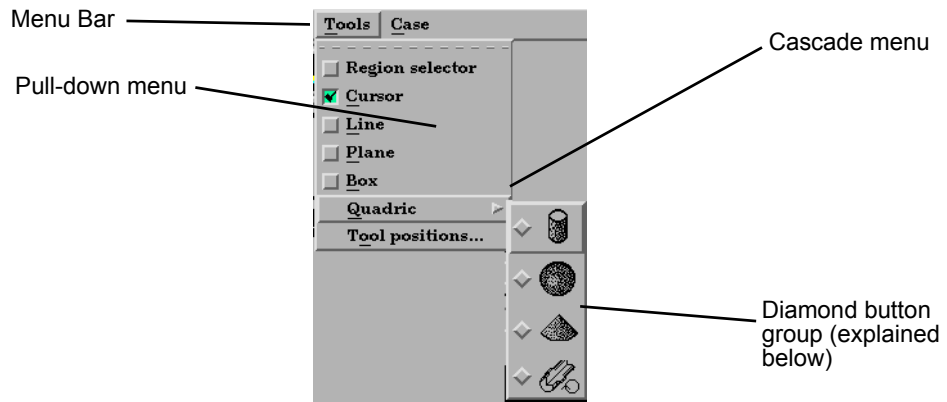

- Menu Bar* A horizontal strip across the top of some dialogs listing menu titles.
- Pull-down menu* A pull-down menu is one accessed directly from a menu bar.
- Cascade menu or submenu* A submenu is accessed from another menu selection. Submenu selections are indicated by a right-pointing arrow.
- Pop-up menu* A pop-up menu is accessed by pressing the associated rectangular button. The current selection from the menu always appears as the button title. (An example is the rectangular button labeled “PRESSURE” beside the word Variable shown above in the Feature Detail Editor.)

Lists

EnSight provides access to the list of Model and Created Parts as well as Original and Created Variables through the Main Parts List and the Main Variables List as well as the sub-lists available in the various Feature Detail Editors. These lists are presented as scrollable sections. Various mechanisms are used to select items from a list for further action:

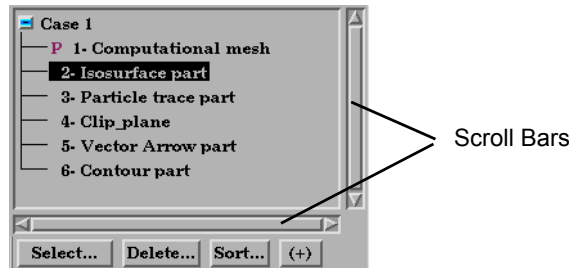

*Select (or single-click)*

Place the mouse cursor over the item and click the left mouse button. The item is highlighted to reflect the “selected” state.

*Select-drag*

Place the mouse cursor over the first item. Click and hold the left mouse button as you drag over the remaining items to be selected. Only contiguous items may be selected in this fashion.

*Shift-click*

Place the mouse cursor over the item. Depress the shift key and click the left mouse button. This action will extend a selection to include all those items sequentially listed between the previous selection and this one.

*Control-click*

Place the mouse cursor over the item. Depress the control key and click the left mouse button. This action will extend a selection by adding the new item, but not those in-between. Use this mechanism to build a non-contiguous selection.

*Double-click*

Place the mouse cursor over the item and click the left mouse button twice in rapid succession.

Buttons

EnSight uses the following kinds of buttons:

*Rectangular*

Place the mouse cursor in the button area and click the left mouse button. Rectangular buttons typically access the function described in the label. If the label is followed by “...” then the button opens another dialog. (Example shown above.)

*Arrow*

Place the mouse cursor in the button area and click the left mouse button. Arrow buttons typically have an associated text field. Clicking the button increments or decrements the text field value. (Example shown below.)

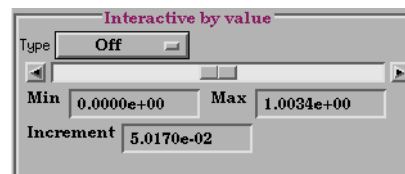

*Triple Slider* Click on the slider above the bar and drag it to change the current step or value. Click on the left slider below the bar and slide to set the begin step or begin value. Click on the right slider below the bar and slide to set the end step or end value. The buttons above the triple slider are traditional VCR controls.

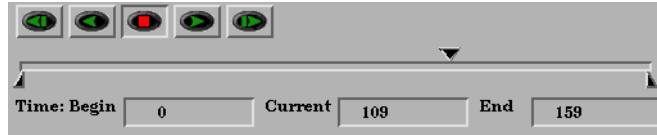

*Diamond* Place the mouse cursor in the button area and click the left mouse button. Diamond buttons (also called radio buttons) are toggles that select an item from a mutually exclusive list. Exactly one diamond button of a group can be on at any given time. (Example shown above.)

*Square* Place the mouse cursor in the button area and click the left mouse button. Square buttons are toggles that access the function indicated by the label (Example shown above.).

*Turndown* Place the mouse cursor in the button area and click the left mouse button. Turndown buttons are toggles for opening and closing a section. A down pointing arrow button indicates an open section. A right pointing arrow button indicates a closed section. (Example shown above.)

## Text Fields

EnSight utilizes three types of text fields:

*Information Text Fields* These text fields are used to report information and cannot be edited by the user. Information text fields are surrounded with a single pixel border.

*Editable Text Fields* Place the mouse cursor in the text field and click to insert a blinking insertion cursor. Several techniques are available to accelerate text editing. Select a single word by double-clicking or the entire string by triple-clicking. Selected text is replaced by subsequent typing. The left and right arrow keys (on most systems) will move the insertion cursor. EnSight does not recognize the change in the text field until you press Return.

Where appropriate, EnSight recognizes the following shortcut specifications for UNIX directories:

- ~/ Expands to your home directory
- ~username/ Expands to the home directory of `username`
- ./ Expands to the current working directory
- ../ Expands to the parent directory of the current working directory

**Tear-Off Menus** If your window system allows it, the EnSight user interface supports “tear-off”



menus. Judicious use of tear-off menus can provide custom, rapid access to frequently used functions. To use tear-off menu.

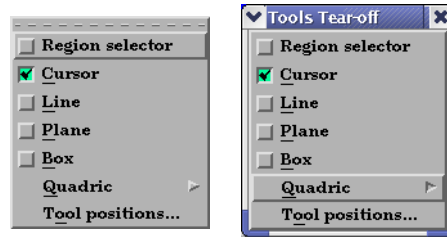

- |                          |  |
|--------------------------|--|
| Select (or single-click) | Place the mouse cursor over a pulldown menu button, then click and release the left mouse button. This operation will open the pulldown menu.  |
| Tear off                 | Move the mouse cursor to the dotted lines on the menu, and again click and release the left mouse button. This will “tear off” the pulldown into a separate window which can be placed anywhere on the screen. |
| Closing a tear-off       | A tear-off menu can be closed by selecting Close from the tear-off window’s frame menu which is accessed clicking on the button in the upper left of the dialog frame.   |
| Dialog Control           | The window manager will normally allow you to control some basic functions (Restore, Move, Raise, Lower, Close) by clicking-holding the right mouse button on a dialog or window border.                       |

## References

The following books provide more information on various aspects of OSF/Motif, X Windows and the Motif Window Manager.

Kobara, Shiz, *Visual Design with OSF/Motif*, Addison-Wesley Publishing Co., Reading, MA, 1991.

Berlage, Thomas, *OSF/Motif: Concepts and Programming*, Addison-Wesley Publishing Co., Wokingham, England, 1991.

Heller, Dan, *Motif Programming Manual (for OSF/Motif Version 1.1)*, X Window System, Vol. 6, O’Reilly & Associates, Inc., 1991.

Open Software Foundation, *OSF/Motif Programmer’s Guide, Revision 1.2*, and *OSF/Motif Programmer’s Reference Revision 1.2*, P T R Prentice-Hall, Inc., Englewood Cliffs, NJ, 1993.

Quercia, Valerie and O’Reilly, Tim, “Appendix C: The OSF/Motif Window Manager,” in *X Window System User’s Guide (Volume Three)* O’Reilly & Associates, Inc., Sebastopol, CA, 1990.



# 6 Main Menu

This chapter describes the functions available from the Main Menu.

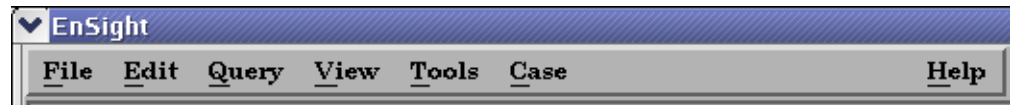

Figure 6-1  
EnSight Main Menu

- [Section 6.1, File Menu Functions](#)
- [Section 6.2, Edit Menu Functions](#)
- [Section 6.3, Query Menu Functions](#)
- [Section 6.4, View Menu Functions](#)
- [Section 6.5, Tools Menu Functions](#)
- [Section 6.6, Case Menu Functions](#)
- [Section 6.7, Help Menu Functions](#)

## 6.1 File Menu Functions

Clicking the File button in the Main Menu opens a pull-down menu which provides access to capabilities which enable you to record and play command files, connect the EnSight Client process to an EnSight Server process, setup or join collaboration sessions with other users, read data into the EnSight Server, load or re-load parts, print and save images, record currently running animations, save and restore various files, archives, and scenarios, and quit from EnSight.

### File Pull-down Menu

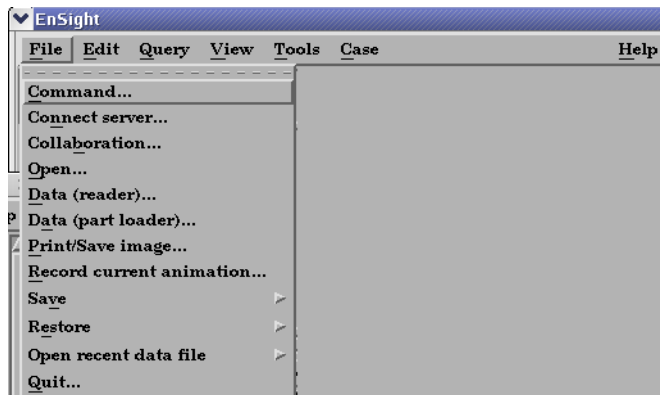

Figure 6-2  
File pull-down menu

- Command...** Opens the Command dialog which is used to record and play Command Files or enter command language directly  
Access: Main Menu > Command...  
(see [Section 2.5, Command Files](#) and [How To Record and Play Command Files](#))
- Connect server...** Opens the Connect Server dialog which is used to perform an Auto or Manual connection from the EnSight Client process to an EnSight Server process.  
Access: Main Menu > Connect server...  
(see [How To Connect Automatically](#))
- Collaboration...** Opens the Collaboration dialog which is used to create a session that can be joined by a colleague, or to join a session that a colleague has opened.  
Access: Main Menu > Collaboration...  
(see [How To Use Collaboration](#))
- Open...** Opens the File selection dialog for use in the quick data loading process. Based on the suffix of the selected file (and the mapping in the `ensight_reader_extension.map` file, which is located in the `.ensight8` subdirectory), the correct reader will be invoked and the data will be loaded. This option skips the Data Reader as well as the Data Part Loader and does a Load All Parts using the default reader options. You can edit the map file to map more data file suffixes to readers.  
Access: Main Menu > Open...  
(see [How to Read Data](#))
- Data (reader)...** Opens the File Selection dialog which is used to specify files you wish to read into EnSight. This method allows more control over the reading process than Open... does.  
Access: Main Menu > Data (reader)...  
(see [Reading and Loading Data Basics, in Section 2.1](#) and [How To Read Data](#))
- Data (part loader)** Opens the Data Part Loader dialog which is used to load parts into EnSight.  
Access: Main Menu > Data (part loader)...  
(see [Reading and Loading Data Basics, in Section 2.1](#) and [How To Read Data](#))

<i>Print/Save image</i>	<p>Opens the Print/save image dialog which is used to print or save images from EnSight.  Access: Main Menu &gt; Print/Save image...  (see <a href="#">Section 2.11, Saving and Printing Graphic Images, How To Print/Save an Image, and How To Output for Povray</a>)</p>
<i>Record current animation...</i>	<p>Opens the Save animation dialog which is used to record the running flipbook or animated trace animation. It will not be available if no animation is currently running.  Access: Main Menu &gt; Record current animation...  (See <a href="#">How To Animate Transient Data, How To Create a Flipbook Animation, and How To Animate Particle Traces.</a>)</p>
<b>Save</b>	<p>Opens a pull-down menu which allows you to choose between the following Save options: Context, Commands from this session, Full backup, Geometric entities, or Scenario.  Access: Main Menu &gt; File &gt; Save</p>
Context...	<p>Opens the Save current context dialog where you can specify the name of a context file to be created. This file saves information needed to reproduce the same basic imagery on a different set of data.  Access: Main Menu &gt; File &gt; Save &gt; Context...  (See <a href="#">How To Save or Restore a Context File</a>)</p>
Command from current session...	<p>Opens the File selection dialog where you can specify the name of a file into which the commands used up to this point in the session will be placed.  Access: Main Menu &gt; File &gt; Save &gt; Commands from this session...  (See <a href="#">How To Record and Play Command Files</a>)</p>
Full backup...	<p>Opens the Save full backup archive dialog which is used to save an entire session as an archive file which can later be used to restore EnSight to the same condition present when the archive file was made.  Access: Main Menu &gt; File &gt; Save &gt; Full backup...  (see <a href="#">Section 2.6, Archive Files and How To Save and Restore an Archive</a>)</p>
Geometric entities...	<p>Opens the Save geometric entities dialog which is used to save selected part geometric information and active variable values from EnSight. EnSight Gold, VRML, Brick of Values, or User-defined writer formats can be selected.  Access: Main Menu &gt; File &gt; Save &gt; Geometric entities...  (see <a href="#">Section 2.9, Saving Geometry and Results Within EnSight and How To Save Geometric Entities</a>)</p>
Scenario...	<p>Opens the Save scenario dialog where you can create a scenario file which can be viewed by CEI's EnLiten product. EnLiten can display any scene created with EnSight and can be run standalone or be embedded in Microsoft applications.  Access: Main Menu &gt; File &gt; Save &gt; Scenario...  (See <a href="#">How To Save Scenario</a>)</p>
<b>Restore</b>	<p>Opens a pull-down menu which allows you to choose to restore a context or a full backup archive file.  Access: Main Menu &gt; File &gt; Restore</p>
<i>Open Recent Data</i>	<p>Provides a pulldown of recently accessed data files.  Access: Main Menu &gt; File &gt; Open Recent Data...</p>
Context...	<p>Opens the Restore context from file dialog where you can specify the name of a context file to be applied and which case to apply it to. First read in your data, then restore the context. This will do its best to create the same basic imagery (as that when the context file was saved) to your current model.  Access: Main Menu &gt; File &gt; Restore &gt; Context...  (See <a href="#">How To Save or Restore a Context File</a>)</p>

## 6.1 File Menu Functions

- Full backup...** Opens the File selection dialog which is used to specify the archive file to be restored into EnSight. This should bring EnSight to the same condition present when the archive file was saved.  
Access: Main Menu > File > Restore > Full backup...  
(see [Section 2.6, Archive Files](#) and [How To Save and Restore an Archive](#))
- Quit...** Opens the Quit confirmation dialog which allows you to save a command file or/and an archive file before exiting EnSight.  
Access: Main Menu > Quit...  
(see [Section 2.6, Archive Files](#))

## 6.2 Edit Menu Functions

Clicking the Edit button in the Main Menu opens a pull-down menu which provides access to the following features:

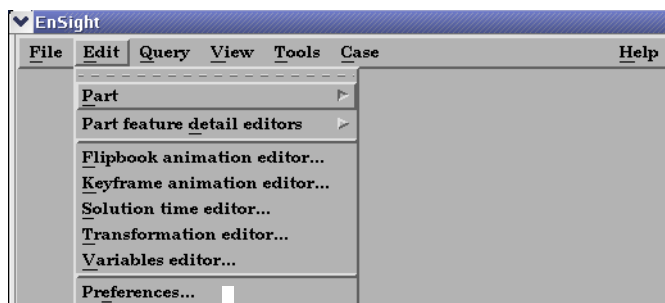

Figure 6-3  
Edit pull-down menu

### *Part*

Opens a pull-down menu which allows you to choose between the following part operations:

- Select All (see Section 3.4, Part Operations and How To Select Parts)
- Select... (see Section 3.4, Part Operations and How To Select Parts)
- Delete... (see Section 3.4, Part Operations and How To Delete a Part)
- Assign to single new viewport (see Section 3.4, Part Operations)
- Assign to multiple new viewports (see Section 3.4, Part Operations)
- Group... & Ungroup (see Section 3.4, Part Operations and How To Group Parts)
- Copy (see Section 3.4, Part Operations and How To Copy a Part)
- Extract (see Section 3.4, Part Operations and How To Extract Part Representations)
- Merge (see Section 3.4, Part Operations and How To Merge Parts)

Access: Main Menu > Edit > Part

### *Part feature detail editors*

Opens a pull-down menu which allows you to choose between the following options to open the Feature Detail Editor:

- Selected part type... (see Section 3.1, Part Overview and Introduction to Part Creation)
- Contours... (see Section 3.3, Part Editing, Section 7.7, Contour Create/Update, and How To Create Contours)
- Clips... (see Section 3.3, Part Editing, Section 7.9, Clip Create/Update, How To Create Line Clips, How To Create Plane Clips, How To Create Quadric Clips, and How To Create IJK Clips)
- Developed surfaces... (see Section 3.3, Part Editing, Section 7.20, Developed Surface Create/Update, and How to Create Developed Surfaces)
- Elevated surfaces... (see Section 3.3, Part Editing, Section 7.14, Elevated Surface Create/Update, and How to Create Elevated Surfaces)
- Isosurfaces... (see Section 3.3, Part Editing, Section 7.8, Isosurface Create/Update, and How to Create Isosurfaces)

- Material parts... (see Section 3.3, Part Editing, Section 7.19, Material Parts Create/Update, and How to Create Material Parts)
- Model parts... (see Section 3.3, Part Editing and Introduction to Part Creation)
- Particle traces... (see Section 3.3, Part Editing, Section 7.11, Particle Trace Create/Update, and How to Create Particle Traces)
- Profiles... (see Section 3.3, Part Editing, Section 7.13, Profile Create/Update, and How to Create Profile Plots)
- Separation/Attachment lines... (see Section 3.3, Part Editing, Section 7.17, Separation/Attachment Lines Create/Update, and How To Extract Separation/Attachment Lines)
- Shock regions/surfaces... (see Section 3.3, Part Editing, Section 7.16, Shock Surface/Region Create/Update, and How To Extract Shock Surfaces)
- Subset parts... (see Section 3.3, Part Editing, Section 7.12, Subset Parts Create/Update, and How to Create Subset Parts)
- Tensor glyphs... (see Section 3.3, Part Editing, Section 7.21, Tensor Glyph Parts Create/Update, and How to Create Tensor Glyphs)
- Vector arrows... (see Section 3.3, Part Editing, Section 7.10, Vector Arrow Create/Update, and How to Create Vector Arrows)
- Vortex cores... (see Section 3.3, Part Editing, Section 7.15, Vortex Core Create/Update, and How To Extract Vortex Cores)

Access: Main Menu > Edit > Part feature detail editors...

*Flipbook animation editor...*

Opens the Flipbook animation editor in the Quick Interaction Area which is used to load, run, and modify Flipbook Animation sequences.

Access: Main Menu > Edit > Flipbook animation editor...

(see Section 7.2, Flipbook Animation and How To Create a Flipbook Animation)

*Keyframe animation editor...*

Opens the Keyframe animation editor in the Quick Interaction Area which is used to create, save, restore, run, and modify Keyframe animation sequences.

Access: Main Menu > Edit > Keyframe animation editor...

(see Section 7.3, Keyframe Animation and How To Create a Keyframe Animation)

*Solution time editor...*

Opens the Solution time editor in the Quick Interaction Area which is used to specify the currently displayed time step in a transient dataset.

Access: Main Menu > Edit > Solution time editor...

(see Section 7.1, Solution Time and How To Animate Transient Data)

*Transformation editor...*

Opens the Transformation editor dialog which is used to precisely position parts, frames, and tools in the Graphics Window and to Save and Restore Views.

Access: Main Menu > Edit > Transformation editor...

(see Chapter 9, Transformation Control)

*Variables editor...*

Opens the Feature Detail Editor (Variables) dialog which is used to obtain information about variables, change the information, and to create new variables.

Access: Main Menu > Edit > Variables editor...

(see Chapter 4, Variables)



**Preferences...**

Opens the Preferences dialog which is used to set or modify preference values for the various categories within EnSight.

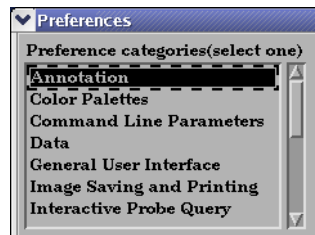

In this area you can set default attributes and preferences which will be used for the current EnSight session. You may also save any of these to various preference file(s) so that they will be the defaults for future invocations of EnSight. Each of the preference categories will now be explained.

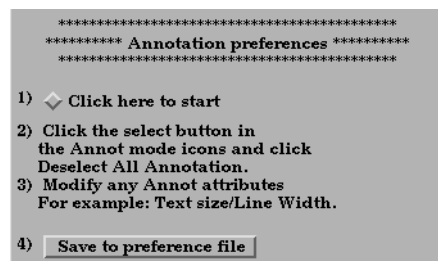
**Annotation Preferences**

*Click here to start*

Will place you in Annotation mode in EnSight. Perform step 2) so that you are editing defaults. You can then change any annotation attributes desired and they will become the defaults for the session.

*Save to preference file*

Will write the current annotation preferences to the preference file for future EnSight sessions.

(see [How To Set Annotation Preferences:](#))

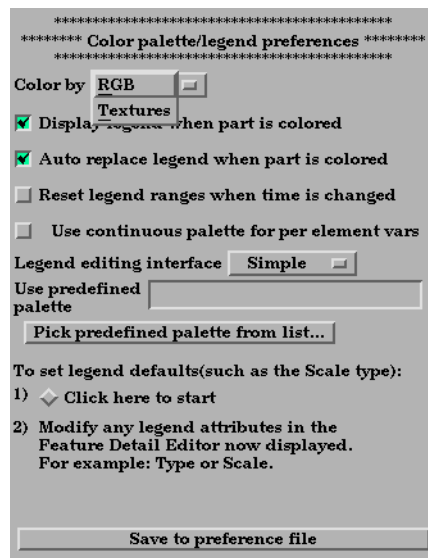
**Color Palettes Preferences**

<i>Color by</i>	Can select RGB or Texture color mode. Texture color mode provides a higher level of color interpolation for models where the mesh density is coarse relative to the spatial rate of change of the variable.
<i>Display legend when part is colored</i>	Will cause the legend to automatically appear when you color a part by a variable.
<i>Auto replace legend when part is colored</i>	Will cause legends to be automatically replaced when the current legend is no longer in use (i.e. no parts are colored by the variable) and a new variable is in use.
<i>Reset legend ranges when time is changed</i>	Will cause legend ranges to be reset according to variable values at the current time.
<i>Use continuous palette for per element vars</i>	By default the legend for Per Element variables has a “Type” of Constant. Toggle this on to change the default “Type” to Continuous.
<i>Legend editing interface</i>	Can be EnSight’s <i>Simple</i> or <i>Advanced</i> interface.
<i>Use predefined palette</i>	Allows you to enter a predefined palette name if you have predefined color palettes.
<i>Pick predefined palette from List...</i>	Allows you to pick from your predefined palette list.
To set legend defaults (such as the Scale Type):	
<i>Click here to start</i>	Will allow you to modify legend default attributes.
<i>Save to preference file</i>	Will write the current legend and palette preferences to the preference file for future EnSight sessions.

(see [How To Set Color Palette Defaults:](#))

Command Line  
Parameter Preferences

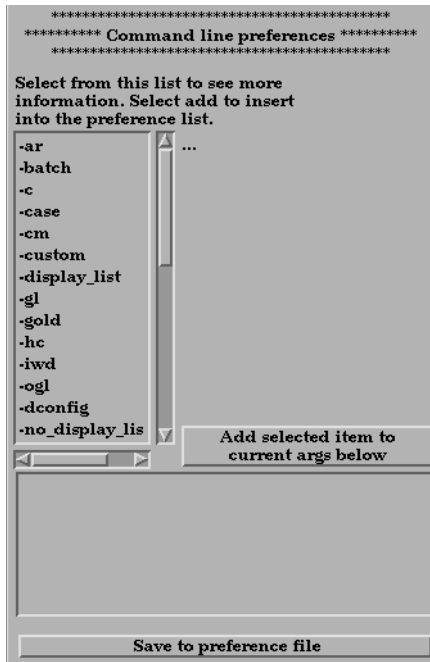

By selecting arguments from the list and hitting:

<i>Add selected item to current args below</i>	You can build customized command line preferences.
--	--

*Save to preference file* Will save the command line preferences to the preference file for future invocations of EnSight.

(see [How To Set Command Line Preferences:](#))

## Data Preferences

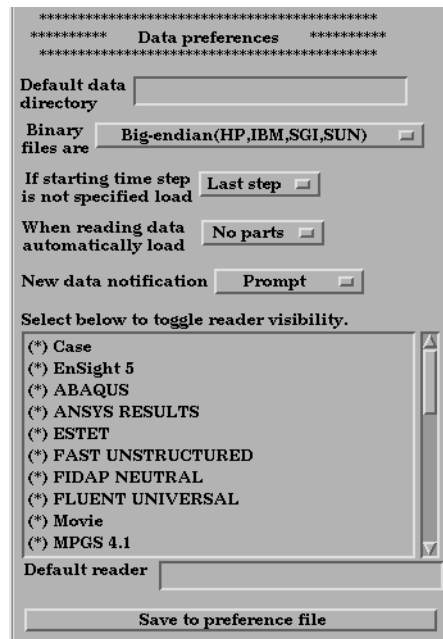

*Default data directory* Will allow you to specify a default directory for data files.

*Binary files are* Allows you to specify the default byte order for binary files. The allowable settings are *Big-endian*, *Little-endian*, or *Native to server machine*.

*If starting time step is not specified load* Can be set so that the default starting time step for transient data can be either *Last step* or *First step*.

*When reading data automatically load* Allows you to have EnSight automatically load *All parts*, *First part*, *Last part*, or *No parts* at startup. If *No parts* is specified, the Part Loader dialog will be presented to the user at startup.

*New data notification* Options for dealing with notification of a change in the model dataset while EnSight is running. Please contact CEI support if you have need of this.

*Select below to toggle reader visibility* Allows you to specify which data formats will appear in the “Format” pull-down of the Data Reader dialog.

*Default reader* Allows you to specify the default data reader format.

*Save to preference file* Will save the data preferences to the preference file for future invocations of EnSight.

(see [How To Set Data Preferences:](#))

General User Interface Preferences

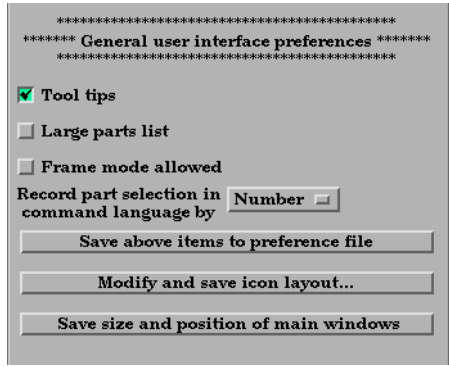

- Tool tips* Will cause pop-up help information to appear when the mouse is placed over certain icons while running EnSight.
- Large parts list* Will cause the parts list to expand to a larger size down the left of the desktop.
- Frame mode allowed* Will display Frame as a managed mode.
- Record part selection in command language by* Allows you to specify whether the part selections recorded in command language will be by part *Name* or by part *Number*.
- Save above items to preference file* Will save the preferences above to the preference file for future invocations of EnSight.
- Modify and save icon layout...* Opens the Icon bar preferences dialog layout....

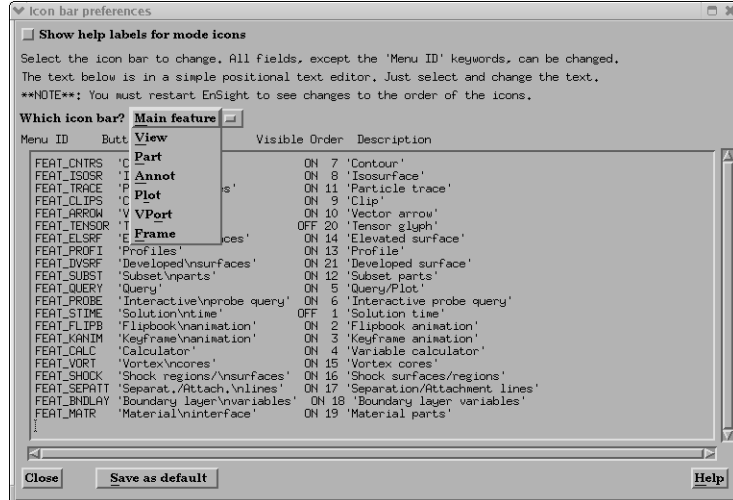

Figure 6-4  
Icon Bar Preferences

- Show help labels for mode icons* When toggled on, the Icon name will appear beneath each icon in the Mode Icon Bar. You can customize the EnSight GUI by specifying which icons appear and their order in the Feature and Mode Icon Bars. Do **NOT** modify the Menu ID for any function. The other fields for each function may be edited within the dialog. Customization options are:

Button Name	Describes the function of the icon which would be displayed if EnSight was started with no icons (command line function). Further, this is the name which will appear below the each Mode Icon when Show Help Labels For Mode Icons is toggled on.
Visible	Determines the visibility of a feature icon. Must be either ON or OFF.
Order	Determines the order in which the icons appear. A value of 1 will cause the icon to appear leftmost in the Main Feature Icon Bar and uppermost in the Mode Icon Bars.
Description	<p>The text description of the button which will be displayed in the Message Area when the icon is selected. You must click the Save As Default button to save any changes you have made. The Button Name and Order, if modified, will not take effect until you restart EnSight. Changes to Visibility, Description, and Show Help Labels however, will be implemented immediately upon clicking the Save as Default button (and will control these options in future EnSight sessions as well).</p> <p>When EnSight is started, the icon preferences are initially read from the \$CEI_HOME/ensight80/site_preferences directory and are then overwritten by any information in the user's preferences directory. (see <a href="#">How To Customize Icon Bars</a>)</p>
<i>Save size and position of main windows</i>	<p>Will record the location and size of the main GUI, and all dialogs that have been opened during the session or are currently open and will make those locations and sizes the default for future sessions of EnSight. Be aware also that if you had a turn-down section open in a dialog (such as General Attributes in the Feature Detail Editor dialog) when you closed it earlier in the session or at the time you choose Save window positions, this will be recorded as well and opening that dialog in future sessions will also open that turn-down section within the dialog. (see <a href="#">How To Save GUI Settings</a>)</p> <p>(see <a href="#">How To Set General User Interface Preferences:</a>)</p>

### Image Saving and Printing Preferences



<i>Click here to start</i>	Will allow you to modify default attributes for image saving and printing.
<i>Save to preference file</i>	Will write the current print/save preferences to the preference file for future EnSight sessions.

(see [How To Set Image Saving and Printing Preferences:](#))

## Interactive Probe Query Preferences

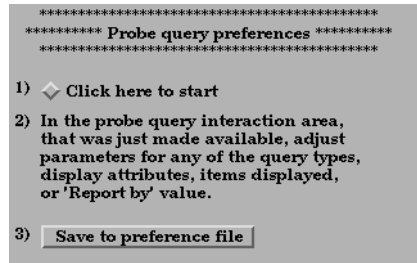

*Click here to start*

Will allow you to modify default attributes for interactive probe queries.

*Save to preference file*

Will write the current interactive probe query preferences to the preference file for future EnSight sessions.

(see [How To Set Interactive Probe Query Preferences:](#))

## Mouse and Keyboard Preferences

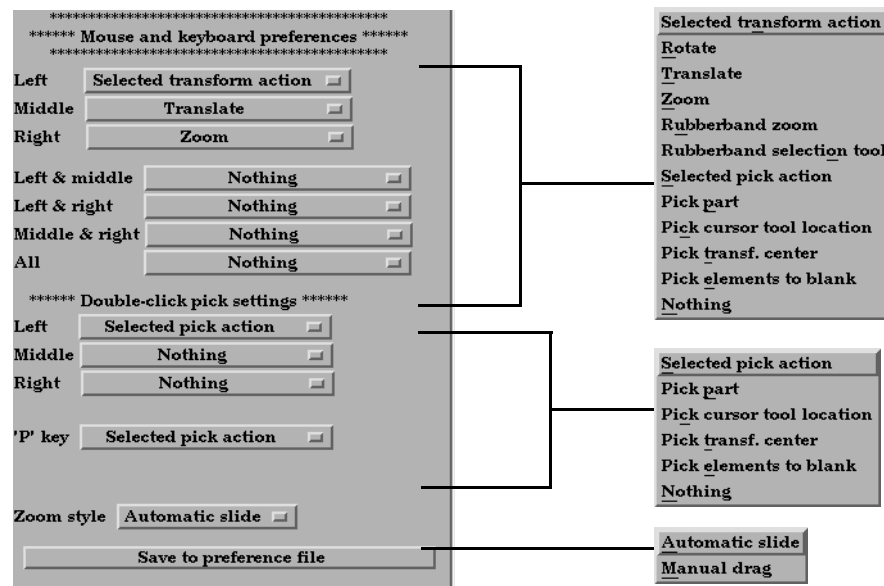

Here you can specify the transformation and picking actions of the three mouse buttons and the keyboard 'P' key. Select the option you wish to assign to each button or combination of buttons. The options are as follows:

**Selected transform action** When this option is chosen (it is the default for the left button), depressing the button and moving the mouse will perform the transformation (rotate, translate, zoom) currently selected in the Transformation Control Area on the desktop.

**Rotate** When this option is chosen, depressing the button and moving the mouse will perform a rotate transformation on the model.

**Translate** When this option is chosen, depressing the button and moving the mouse will perform a translate transformation on the model.

Zoom	When this option is chosen, depressing the button and moving the mouse will perform a zoom transformation on the model.
Rubberband zoom	When this option is chosen, depressing the button will cause the rubberband zoom rectangle to appear and dragging it will modify the zoom area.
Rubberband selection tool	When this option is chosen, depressing the button will bring up the rubberband selection tool that you can then manipulate.
Selected pick action	When this option is chosen, depressing the button will perform a pick operation. If Pick has not been assigned to one of the mouse buttons, the “p” key is used to perform the operation. (see Pick Pull-down Icon in <a href="#">Section 8.1, Part Mode</a> )
Pick Part	When this option is chosen, depressing the button will pick the part in the part list.
Pick cursor tool location	When this option is chosen, depressing the button will pick the location for, and move the cursor tool.
Pick transf. center	When this option is chosen, depressing the button will pick the location for the new center of transformation. Subsequent rotations, etc. will be about this picked location.
Pick elements to blank	When this option is chosen, depressing the button will blank the element under the pointer (if element blanking is enabled).
Nothing	When this option is chosen, no function is mapped to the mouse button.

*Note: One of the Mouse buttons must be assigned to Selected transform action. Macros cannot be assigned to a mouse key which has a function assigned to it. (see [How To Customize Mouse Button Actions](#))*

<i>Zoom style</i>	Choose method to use for zoom action. For either option, zooming stops when the mouse button is released.
Manual drag	Zoom DISTANCE is based on the distance you move your mouse when the mouse button is pressed.
Automatic slide	Zoom Velocity is based on the distance the mouse is moved when the mouse button is pressed.
<i>Save to preference file</i>	Will write the current mouse and keyboard preferences to the preference file for future EnSight sessions.

(see [How To Set Mouse and Keyboard Preferences](#):)

Parts

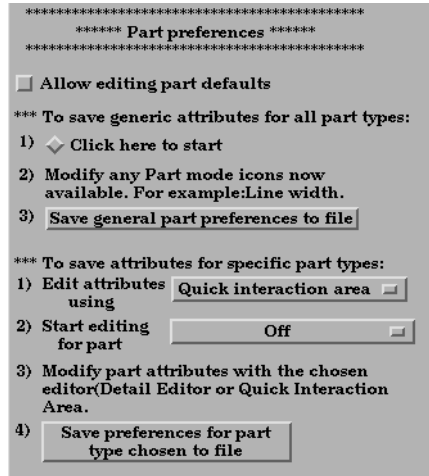

Allow editing part defaults

In EnSight 8 you can change a default attribute, such as line width, by making sure there are no parts selected in the main part list and changing an icon under Part mode. We used to pop up a message to warn the user that they are changing a default instead of a particular part if they forgot to select one. This preference now allows or disallows changing a default attribute. These default attributes will be used for any part created or loaded in the future, so that the user doesn't have to keep changing each new part.

Generic Attributes:  
*Click here to start*

Will allow you to modify default visual part attributes which apply to all part types.

*Save general part preferences to file*

Will write the current generic part preferences to the preference file for future EnSight sessions.

Attributes For Specific Part Types:

*Edit attributes using*

Allows you to specify which area to use for default attribute modification - the *Quick interaction area* or the *Detail editor dialog*.

*Start editing for part*

Allows the user to specify the part type for which default attributes will be modified.

*Save preferences for part type chosen to file*

Will write the current specific part type preferences to the preference file for future EnSight sessions.

(see [How To Set Part Preferences](#).)

Performance Preferences

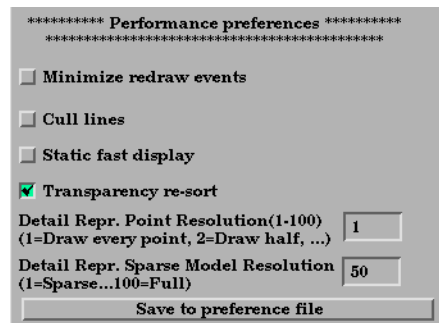



<i>Minimize redraw events</i>	Will use pixel saving and restoring to advantage for window moves, etc. Useful if graphics card does fast pixel read/writes.
<i>Cull lines</i>	Will only draw shared lines between polygons once.
<i>Static fast display</i>	Will cause the fast representation to always be displayed. If this is off (the default), fast display will only be active during a transformation.
<i>Transparency re-sort</i>	Causes polygons to be resorted with each transformation - so the image is always correct. If not on, the polygons will not be resorted while the mouse is down during transformations, but will be resorted when the mouse is released.
<i>Detail Repr. Point Resolution</i>	Allows specification of fraction of nodes to display in Fast Display, point representation. (The default is "1", indicating all nodes, "2" would be every other node, "3" every third node, etc.)
<i>Detail Repr. Sparse Model Resolution</i>	Allows specification of the percentage of the model geometry that will be displayed. (immediate mode only)
<i>Save to preference file</i>	Will write the current performance preferences to the preference file for future EnSight sessions.

(see [How To Set Performance Preferences:](#))

## Plotter Preferences

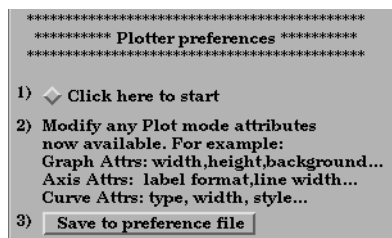

<i>Click here to start</i>	Will allow you to modify defaults for the various plotter graph, axis, and curve attributes.
<i>Save to preference file</i>	Will write the current plotter preferences to the preference file for future EnSight sessions.

(see [How To Set Plotter Preferences:](#))

## Query Preferences

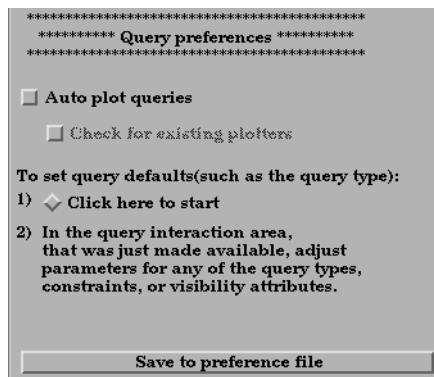

<i>Auto plot queries</i>	Automatically plot a newly created query to a plotter. The plot will go into a new or an existing plotter, depending on the state of the “ <i>Check for Existing Plotters</i> ” toggle.
<i>Check for existing plotters</i>	Check for plotters of the same type (same X and Y units) as the new query is being autoplotting. If one exists, plot the query to the existing plotter.
<i>Click here to start</i>	Will allow you to modify defaults for the various query attributes.
<i>Save to preference file</i>	Will write the current query preferences to the preference file for future EnSight sessions.

(see [How To Set Query Preferences:](#))

## User Defined Input Preferences

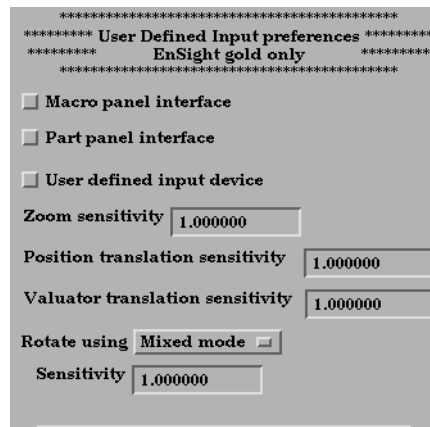

This area provides access to user defined input devices. The input devices include a Macro Panel Interface (a grid of commands that displays in the Main Graphics window and executes EnSight command files upon selection), and/or a User Defined Input Device (a virtual input device designed for - but not limited to - use with VR environments such as an Immersadesk)

<i>Macro panel interface</i>	Toggles on/off the user defined macro panel (defined in your <code>~/ensight8/macros/hum.define</code> file) to the Main Graphics window. (An example <code>hum.define</code> file is located at <code>\$(CEI_HOME)/ensight8/src/input/HUM/hum.define</code> on your client system.).
<i>Part panel interface</i>	Display a part list in the graphics window. This is helpful when in full screen mode or in a VR environment, to allow picking of parts that can be operated on via macros.
<i>User defined input device</i>	Toggles on/off the User Defined Input Device that is linked via a runtime library. (Steps outlining the implementation of this library and input device are found in the file: <code>\$(CEI_HOME)/ensight80/src/input/README</code> on your client system.).
<i>Zoom sensitivity</i>	Specifies a positive scalar value that adjusts the Sensitivity of the zoom input device (i.e. values $< 1$ are slower, and values $> 1$ are faster).
<i>Position translational sensitivity</i>	Specifies a positive scalar value that adjusts the Sensitivity of a positional translation input device (i.e. values $< 1$ are slower, and values $> 1$ are faster).

<i>Valuator translational sensitivity</i>	Specifies a positive scalar value that adjusts the Sensitivity of a valuator translation input device (i.e. values < 1 are slower, and values > 1 are faster).				
<i>Rotate using</i>	Opens a pull-down menu for selection of the type of input device used to record rotation transformations. <table> <tr> <td><i>Mixed mode</i></td> <td>A device that returns virtual angle values where the Z rotations correspond to (literal) movement of the input device about its local Z (or roll) axis; and where the X and Y rotations correspond to translational movements of the input device with respect to its local X and Y axes.</td> </tr> <tr> <td><i>Direct mode</i></td> <td>A device that returns virtual angle values that correspond to (literal) rotational movements of the input device about its local X, Y, and Z axes.</td> </tr> </table>	<i>Mixed mode</i>	A device that returns virtual angle values where the Z rotations correspond to (literal) movement of the input device about its local Z (or roll) axis; and where the X and Y rotations correspond to translational movements of the input device with respect to its local X and Y axes.	<i>Direct mode</i>	A device that returns virtual angle values that correspond to (literal) rotational movements of the input device about its local X, Y, and Z axes.
<i>Mixed mode</i>	A device that returns virtual angle values where the Z rotations correspond to (literal) movement of the input device about its local Z (or roll) axis; and where the X and Y rotations correspond to translational movements of the input device with respect to its local X and Y axes.				
<i>Direct mode</i>	A device that returns virtual angle values that correspond to (literal) rotational movements of the input device about its local X, Y, and Z axes.				
<i>Sensitivity</i>	Specifies a positive scalar value that adjusts the Sensitivity of the type of rotation input device selected in Rotate Using (i.e. values < 1 are slower, and values > 1 are faster). (see <a href="#">How To Enable User Defined Input Devices</a> )				
<i>Save to preference file</i>	Will write the current user defined input preferences to the preference file for future EnSight sessions.				

(see [How To Set User Defined Input Preferences:](#))

## Variables Preferences

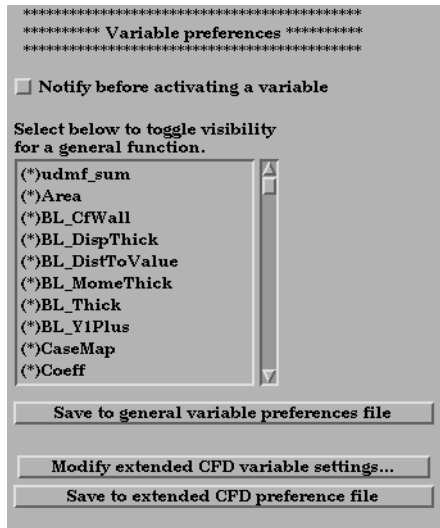

<i>Notify before activating a variable</i>	Will cause you to be notified before a variable, which was going to be automatically activated, is actually activated.
<i>Select below to toggle visibility for a general function</i>	Toggle visibility of functions in the General Functions list of the new variable calculator dialog. There are many general functions and this allows you to limit the list to only functions that you wish to use.
<i>Save to general variable preferences file</i>	Will write the variable notification preference to the preference file for future EnSight sessions.

*Modify extended CFD variable settings...*

Opens the Extended CFD variable settings dialog. If your data defines variables or constants for density, total energy per unit volume, and momentum (or velocity), it is possible to show new variables defined by these basic variables in the Main Variables List of the GUI by utilizing the capabilities of this dialog.

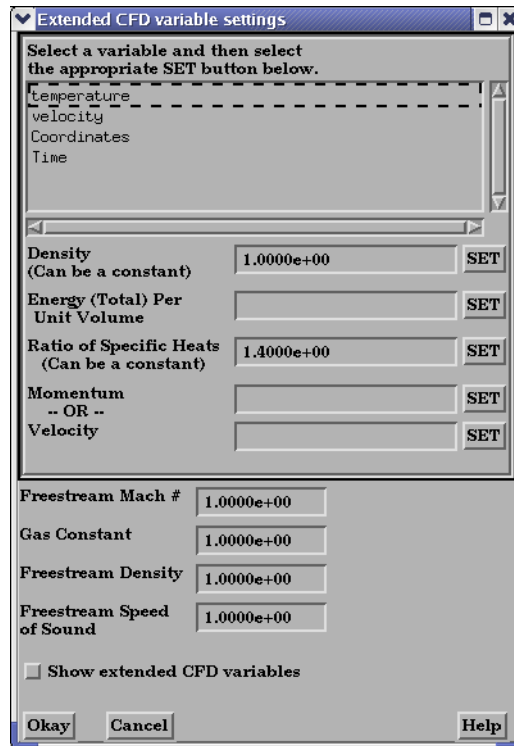
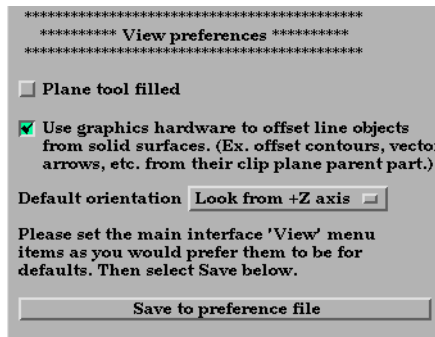

Figure 6-5  
Extended CFD variable settings dialog

Density	Permits the selection of the density variable from the list (click SET after selection) or the specification of a constant value in the field provided.
Energy (Total) Per Unit Volume	Permits the selection of the energy variable from the list. Click SET after selection.
Ratio of Specific Heats	Permits the selection of the ratio of specific heats variable from the list (click SET after selection) or the specification of a constant value in the field provided.
Momentum OR Velocity	Permits the selection of the momentum or velocity variable from the list. Click SET after selection.
Freestream Mach #	Permits the specification of the freestream mach number in the field provided.
Gas Constant	Permits the specification of the gas constant in the field provided.
Freestream Density	Permits the specification of the freestream density value in the field provided.

Freestream Speed of Sound	Permits the specification of the freestream speed of sound value in the field provided.
Show Extended CFD Variables	When selected, all of the variables that can be derived from the information entered will be shown in the Main Variables List of the GUI. (Will not take effect until the Okay button is clicked.)
Okay	Clicking this button applies the changes made in the dialog. (See <a href="#">How To Create New Variables</a> )
<i>Save to extended CFD preference file</i>	Will write the current extended CFD preferences to the extended CFD preference file for future EnSight sessions. (see <a href="#">How To Set Variable Preferences:</a> )

## View Preferences



<i>Plane tool filled</i>	Will cause the plane tool to be a filled transparent surface. If it is off, the plane tool will be in line drawing mode. You can save this default to the preference file.
<i>Use graphics hardware to offset line objects</i>	There are two offsets employed in EnSight. This one, hardware offset, is perpendicular to the monitor screen, and done in hardware if this toggle is on. This will allow, for example, contour lines to appear closer to the viewer than their parent part so they are visible no matter what orientation the part is viewed from. The second offset is the display offset. The display offset can be set in the feature detail editor for line parts such as contour lines, particle trace lines, vector arrows, and separation/attachment lines. The display offset is the distance in the direction of the element normal (perpendicular to the surface).
<i>Default orientation</i>	The default axis for viewing can be selected and set.
<i>Save to preference file</i>	Will write the current view preferences to the preference file for future EnSight sessions.

(see [How To Set View Preferences:](#))

Viewports Preferences

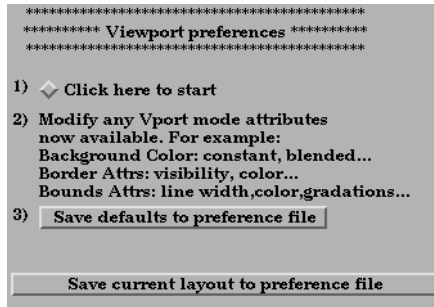

*Click here to start*

Will allow you to modify default viewport attributes.

*Modify any Vport mode attributes now available*

Select Vport along the left side of the main window. The attributes for viewports will appear in the iconbar for you to modify. Attributes as shown above and many others may be set.

*Save defaults to preference file*

Will write the current viewport default values to a preference file for future EnSight sessions.

*Save current layout to preference file*

Will write out the current viewport screen layout to a file for future EnSight sessions.

## 6.3 Query Menu Functions

Clicking the Query button in the Main Menu opens a pull-down menu which provides access to the following features:

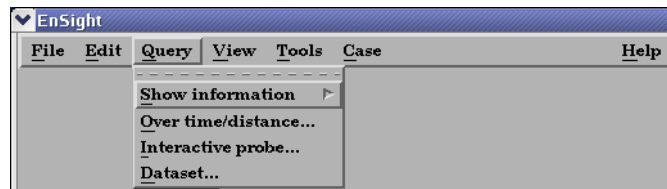

Figure 6-6  
Query pull-down menu

EnSight provides several ways to examine information about variable values. You can, of course, visualize variable values with fringes, contours, vector arrows, profiles, isosurfaces, etc. Only parts with data residing on the Server host system may be queried. Thus, parts that reside exclusively on the Client host system (i.e. contours, particle traces, profiles, vector arrows) may NOT be queried.

(see [Table 3–2 Part Creation and Data Location](#))

### Show information

Opens the following pull-down menu:

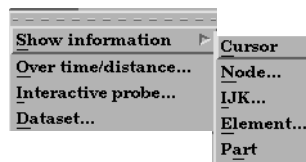

Figure 6-7  
Show information pull-down menu

Access: Main Menu > Query > Show information

(see [How To Get Point, Node, Element and Part Information](#))

### Cursor

Provides the following information in the Status History Area about a Point inside of the selected Part(s) who's position you have specified with the cursor tool:

x,y,z coordinates, Frame assignment of Point, the Part that the Point is found in, the closest Node to the Point, the element id if it exists, and the active Variable values at the Point

Access: Main Menu > Query > Show information > Point

(see [How To Get Point, Node, Element and Part Information](#) and [How To Use the Cursor \(Point\) Tool](#))

### Node...

Opens the Query prompt dialog which is used to specify Node ID number.

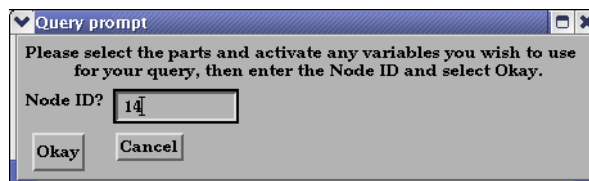

Figure 6-8  
Query Prompt dialog

When the Okay button is pressed, the following information about the specified Node is shown in the Status History Area:

x,y,z coordinates, Frame assignment of Node, the Part that the Node is found in, the element id if it exists, and all active nodal Variable values at the Node

Access: Main Menu > Query > Show Information > Node...  
(see [How To Get Point, Node, Element and Part Information](#))

IJK... Opens the Query Prompt dialog which is used to specify IJK values.

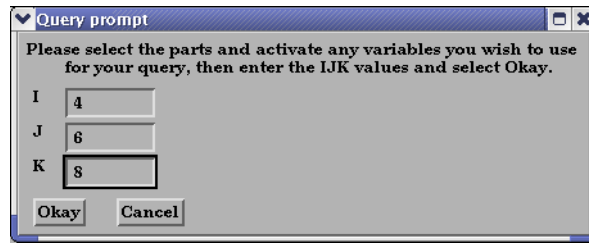

Figure 6-9  
Query Prompt for IJK Values

When Okay button is pressed, the following information about the Node specified by the IJK values is shown in the Status History Area:

Node ID, Part in which the Node is located, x,y,z coordinates of the Node,  
Frame assignment of the Node, and the specified Variable value at the Node.

Access: Main Menu > Query > Show Information > IJK...

(see [How To Get Point, Node, Element and Part Information](#))

Element... Opens the Query Prompt for Element ID.

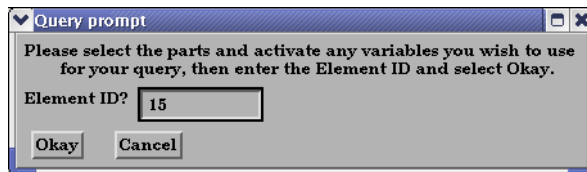

Figure 6-10  
Query Prompt for Element ID

When Okay button is pressed, the following information about the Element is shown in the Status History Area:

Part in which Element is located, Type of Element, IJK bounds (if a structured mesh), Number of Nodes, Node ID numbers, information on neighboring Elements, and all active elemental Variable values at the Element.

Access: Main Menu > Query > Show Information > Element...

(see [How To Get Point, Node, Element and Part Information](#))

Part Causes the following information about the Part to be shown in the Status History Area:  
Part type (structured or unstructured), number of Nodes in Part, minimum and maximum x,y,z coordinates, Element type, min/max node labels if exist, min/max element labels if exist, and the number of Elements.

Access: Main Menu > Query > Show Information > Part

(see [How To Get Point, Node, Element and Part Information](#))

Over time/distance... Opens the Query/Plot Editor in the Quick Interaction Area which is used to obtain information about variables and to create plots of the information.

Access: Main Menu > Query > Over time/distance...

(see [Section 7.5, Query/Plot, How To Query/Plot](#))

Interactive probe... Opens the Interactive Probe Query Editor in the Quick Interaction Area which is used to obtain information interactively about variables.

Access: Main Menu > Query > Interactive probe...

(see [Section 7.6, Interactive Probe Query and How To Probe Interactively](#))



**Dataset...**

Opens the Query Dataset dialog which is used to obtain information about datasets for the selected case.

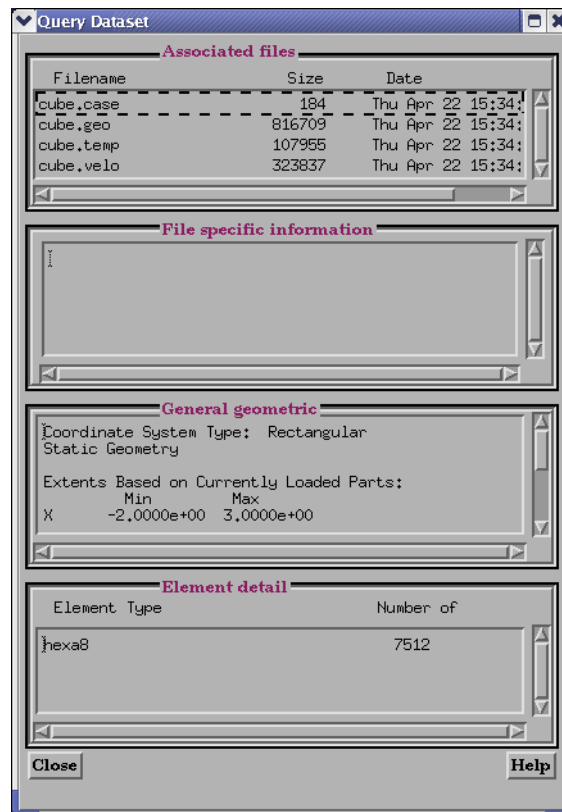

Figure 6-11  
Query Dataset dialog

For the specified file, specific, general and detail information is provided.

Access: Main Menu > Query > Dataset...

(see Section 7.5, Query/Plot and How To Query Datasets)

## 6.4 View Menu Functions

Clicking the View button in the Main Menu opens a pull-down menu which provides access to the following features:

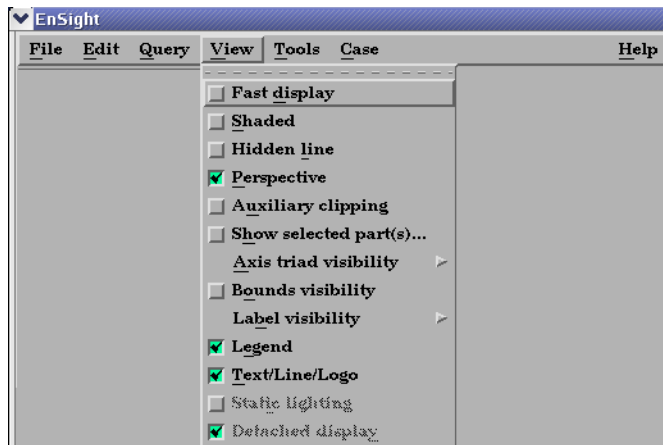

Figure 6-12  
View pull-down menu

### *Fast display*

Toggles the Fast display mode.

Access: Main Menu > View > Fast display

Fast Display in this pull-down is the same as the one located on the Desktop.

By default, EnSight displays all of the lines and elements for each part every time the Main View window redraws. If you have very large models (or if you have slow graphics hardware), each redraw can take significant time. As a result, interactive transformations become jerky and lag behind the motion of the mouse. Ironically, the slower the graphics performance, the harder it is to perform precise interactive transformations. To avoid this problem, you can tell EnSight to show a lesser detailed part representation, i.e, a bounding box surrounding each Part, or the Part as a point cloud. You can select to show the detail representation all the time, or only while you are performing transformations. This obviously displays much less information, but may be sufficient if you want to rotate a very large model.

A lesser detail display is also useful when experimenting with keyframe-animation rates. Using lesser detail, the display rate can be adjusted to approximate the video rate, thus you can see how your scene will transform on the video tape

The default setting is off, indicating that all lines and elements of all visible parts will be redrawn. When on, the redraw will show only the part's Fast Display Representation (by default a box). The fast display representation is only used while transformations are being performed. The fast display representation will be continuously displayed if the Static Fast Display option is turned on in:

Main Menu > Edit > Preferences > Performance > Static fast display.

### *Shaded Toggle*

Toggles the *Global Shaded* mode for parts on and off. EnSight by default displays parts in line mode. Shaded mode displays parts in a more realistic manner by making hidden surfaces invisible while shading visible surfaces according to specified lighting parameters. Parts in Shaded mode require more time to redraw than when in line mode, so you may wish to first set up the Graphics Window as you want it, then turn on Shaded to see the final result. Shaded can be toggled on/off for individual parts by using the Shaded Toggle icon in the Part Mode Icon Bar.

Access: EnSight dialog > View > Shaded  
or Desktop > Shaded

(see Section 8.6, [Quick Desktop Buttons](#) and [How To Set Drawing Style](#))

## Troubleshooting Hidden Surfaces and Shading

Problem	Probable Causes	Solutions
Main View shows line drawing after turning on Shaded.	Shaded is toggled off for each individual part.	Toggle Shaded on for individual parts with the Shaded Icon in Part Mode or in the Feature Detail Editor dialog.
	There are no surfaces to shade—all parts have only lines.	If parts are currently in Feature Angle representation, change the representation. If model only has lines, you can not display shaded images.
	The element visibility attributes has been toggled off for the part(s).	Toggle the element visibility on for individual parts in the Feature Detail Editor dialog.

### Hidden line

Toggles the global Hidden line display for all parts on/off. This simplifies a line drawing display by making hidden lines - lines behind surfaces - invisible while continuing to display other lines. Hidden Line can be combined with Shaded to display both surfaces and the edges of the visible surface elements. Hidden Line can be toggled on/off for individual parts by using the Hidden Line Toggle icon in the Part Mode Icon Bar. To have lines hidden behind surfaces, you must have surfaces (2D elements). If the representation of the in-front parts consists of 1D elements, the display is the same whether or not you have Hidden Lines mode toggled-on. During interactive transformations, the display reverts to displaying all lines. When you release the mouse button, the Main View display automatically resumes Hidden Line mode. The Hidden line option will not be active during playback of flipbook animations.

Hidden line overlay is disabled if transparency is turned on.

Access: Main Menu > View > Hidden line

(see Section 8.6, [Quick Desktop Buttons](#) and [How To Set Drawing Style](#))

### Hidden line overlay dialog

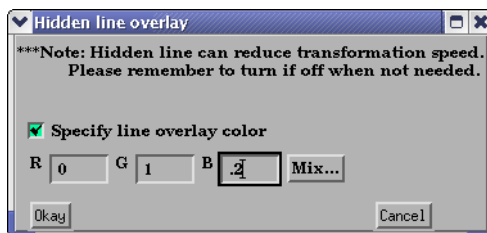

Figure 6-13  
Hidden line overlay dialog

If you combine Shaded mode with Hidden line mode, the lines overlay the surfaces. The Hidden line overlay dialog will pop-up on the screen if the Shaded option is currently on and you then turn the Hidden Line option on. From this dialog you specify a color for the displayed lines (you do not want to use the same color as the surfaces since they then will be indistinguishable from the surfaces). The default is the part-color of each part, which may be appropriate if the surfaces are colored by a color palette instead of their part-color.

Specify line  
overlay color

Toggle-on if you want to specify an overlay color. If off, the overlay line color will be the same as the part color.

R, G, B	The red, green, and blue components of the hidden line overlay. These fields will not be accessible unless the Specify Overlay option is on.
Mix...	Click to interactively specify the constant color used for the hidden line overlay using the Color selector dialog. (see <a href="#">Section 8.1, Color Selector</a> ) and <a href="#">How To Change Color</a> )
Okay	Click to accept the hidden line overlay color options.
<i>Perspective (Global) Toggle</i>	Toggles the view within each of the viewports within the Graphics Window between a perspective view (the default) and an orthographic projection. <i>Perspective</i> is what gives you the sense of depth when viewing a three dimensional scene on a two dimensional surface. Objects that are far away look smaller and parallel lines seem to meet at infinity. <i>Orthographic projection</i> removes the sense of depth in a scene. Lines that are parallel will never meet and objects of the same size all appear the same no matter how far away they are from you. Orthographic projection mode often helps when you are positioning the Cursor, Line, and Plane tools using multiple viewports. This is the Global toggle. Each viewport also has a Perspective Toggle. Access: Main Menu > View > Perspective (see <a href="#">Section 8.4, VPort Mode</a> and see <a href="#">How To Set Global Viewing</a> )
<i>Auxiliary clipping</i>	Toggles the Auxiliary clipping feature on/off. (Default is Off). Like a Z-Clip plane, Auxiliary clipping cuts-away a portion of the model. When Auxiliary clipping is On, Parts (or portions of Parts) located on the back (negative-Z) side of the Plane Tool are removed. Parts whose Clip attribute you have toggled off (in the General Attributes section of the Feature Detail Editor dialog or with the Auxiliary clipping Toggle Icon in the Part Mode Icon Bar) remain unaffected. Auxiliary clipping is interactive—the view updates in real time as you move the Plane Tool around (see <a href="#">Section 6.5, Tools Menu Functions</a> and <a href="#">How To Use the Plane Tool</a> ). Unlike a Z-Clip plane, Auxiliary clipping applies only to the parts you specify, and the plane can be located anywhere with any orientation though it is always infinite in extent (see <a href="#">Section 9.6, Z-Clip</a> and <a href="#">How To Set Z Clipping</a> ). Auxiliary clipping is helpful, for example, with internal flow problems since you can “peel” off the outside parts and look inside. This capability is also often useful in animation. The position of the Plane Tool and the status of Auxiliary clipping is the same for all displayed viewports. Do not confuse Auxiliary clipping with a 2D-Clip plane, which is a created part whose geometry lies in a plane cutting through its parent parts or with the Part operation of cutting a part. (see <a href="#">Section 3.4, Part Operations</a> , <a href="#">How to Create Plane Clips</a> , and <a href="#">How To Cut a Part</a> ).

### *Troubleshooting Auxiliary Clipping*

Problem	Probable Causes	Solutions
The Plane Tool does not appear to clip anything	The Auxiliary Clipping toggle is off for all parts.	Turn the Auxiliary Clipping toggle on for individual parts in the Feature Detail Editor (Model) dialog General Attributes section.
	The Plane Tool is not intersecting the model	Change the position of the Plane Tool.

Problem	Probable Causes	Solutions
The Main View window shows nothing other than the Plane Tool after Clipping is toggled-on.	All of the part(s) is(are) on the back side of the Plane Tool and is(are) thus clipped	Change the position of the Plane Tool.
<i>Show selected part(s)...</i>	Opens the Selected Part(s) Window, in which any selected parts are shown. This often aids in the identification of parts.	
<i>Axis triad visibility</i>	Opens the pull-down menu which allows you to toggle on/off the visibility of the Global axis triad, the axis triads for all Frames, and the model axis triad.	
Frame Toggle	Toggles on/off (default is On) the display of all coordinate Frame axis triads. The visibility of individual coordinate Frame axes can be selectively turned on/off by clicking on the Frame's axis triad and then clicking on the Frame Axis Triad Visibility Toggle in the Frame Mode Icon Bar. Access: Main Menu > View > Axis triad visibility > Frame (see Section 8.5, Frame Mode)	
Global Toggle	Toggles on/off (default is Off) the display of the global coordinate frame axis. The global coordinate frame axis triad represents the Look-At Point. Access: Main Menu > View > Axis triad visibility > Global	
Model Toggle	Toggles on/off the display of the model axis triad in the lower left of the screen. This triad is not at the origin of frame 0, but is aligned with it. Access: Main Menu > View > Axis triad visibility > Model (see Section 8.6, Quick Desktop Buttons)	
<i>Bounds visibility</i>	Toggles on/off (default is Off) the extents box for all parts.	
<i>Label visibility</i>	Opens the pull-down menu which allows you to toggle on/off the visibility of labels for Elements or Nodes.	
Element labeling Toggle	Toggles on/off (default is Off) the global visibility of labels (if they are available in the dataset) for elements in all parts. Visibility of element labels for individual parts can be controlled via the Node/Element labeling icon of Part Mode. Access: Main Menu > View > Label Visibility > Element labeling	
Node labeling Toggle	Toggles on/off (default is off) the global visibility of labels (if they are available in the dataset) for nodes in all parts. Visibility of node labels for individual parts can be controlled via the Node/Element labeling icon of Part Mode. Access: Main Menu > View > Label Visibility > Node labeling	
Labeling attributes...	Opens the Node/Element labeling dialog from which you can control the labeling visibility, color, and filtering for selected parts. This same dialog can also be reached from the Node/Element labeling icon in Part Mode. Access: Main Menu > View > Label Visibility > Labelling attributes...	
<i>Legend Toggle</i>	Toggles on/off (default is on) the global visibility of all legends. Visibility of individual legends can be controlled by using the Edit legends button in Annot Mode. Access: Main Menu > View > Legend (see Section 4.2, Variable Summary & Palette, Section 8.2, Annot Mode and How To Create Color Legends.	

- Text/Line/Logo Toggle*** Toggles on/off global visibility for text strings and lines which have been created and logos which have been imported. Visibility of individual Text strings, Lines, or Logos can be controlled by selecting the item while in Annotation Mode and clicking the Visibility Toggle in the Annotation dialog. While in Annot Mode, you will notice that the item does not disappear, but turns transparent. Such items will not appear in the Graphics Window in any Mode except Annotation Mode, and then only if global visibility has been turned on.  
Access: Main Menu > View > Text/Line/Logo  
(see Section 8.2, [Annot Mode](#), [How To Create Lines and Arrows](#), [How To Create Text Annotation](#), and [How To Load Custom Logos](#).)
- Static lighting*** Toggles on/off whether the light source moves as the model transforms, or instead remains stationary. Static lighting only affects shaded surfaces (i.e., Hidden Surfaces mode is toggled-on). When the Static lighting option is *off* (the default), the light source remains fixed as you transform the model. Your graphics hardware performs the lighting calculations *each time the Graphics Window redraws*.  
When the Static Lighting option is on, the light source moves with the model (it is the lighting *of the model* that remains “static”). EnSight performs the lighting equations *once*. This can greatly improve graphics performance, especially when color fringes are on in which case the performance boost may be as much as a factor of five. Also, memory requirements are somewhat less with Static Lighting, an important point to remember if you are loading flipbook animation pages as objects. However, keep in mind that this performance improvement comes at the cost of realism since the display’s lighting does not update when the scene moves. Note: Static lighting is only available for Edit > Preferences > Color > Color by RGB.  
Access: Main Menu > View > Static lighting
- Detached display*** This menu item is disabled unless using a detached display. If you have a detached display then it’s automatically enabled and toggled on, and this menu item allows toggling on/off this detached display.

## 6.5 Tools Menu Functions

The Region selector, Cursor, Line, Plane, Box, and Quadric (cylinder, sphere, cone, and revolution) Tools in EnSight are used for a variety of tasks, such as: positioning of clipping planes and lines, query operations, particle trace emitters, etc. Collectively these tools are referred to as Positioning Tools. Clicking the Tools button in the Main Menu opens a pull-down menu which provides access to these features:

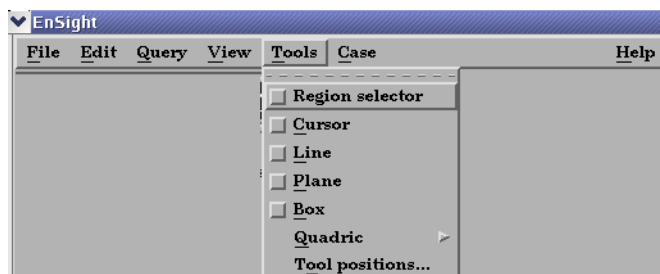

Figure 6-14  
Tools pull-down menu

### *Region selector Toggle*

Makes the Selection Tool (region selector) visible/invisible in the Graphics Window. The Selection Tool appears as a white rectangle with two symbols at the upper left of the tool (one is for zooming and the other for element blanking). It may be repositioned interactively in the Graphics Window by selecting and dragging it or by selecting any corner and rubber banding the corner. Note that a dotted rectangle, which stays at the same aspect ratio of the screen, will indicate the actual selection area as it is manipulated. Alternatively, you can reposition it precisely by specifying X and Y min/max coordinates in the Transformation Editor dialog (described in Tool Positions...Region Tool below).

Access: Main Menu > Tools > Region selector  
or Desktop > Selection tool

(see [Section 8.1, Part Mode](#) and [How to Use the Selection Tool](#))

### *Cursor Tool Toggle*

Makes the Cursor Tool visible/invisible in the Graphics Window. The Cursor Tool appears as a three-dimensional cross colored red, green, and blue. The red axis of the cross corresponds to the X axis direction for the currently selected Frame, while green matches the Y and blue matches up with the Z. The Cursor Tool is initially located at the Look-At point and may be repositioned interactively in the Graphics Window by selecting and dragging it or by selecting Pick Cursor Location from the Pick Pull-down Icon menu in the Quick Desktop Button region. Alternatively, you can reposition it precisely by specifying coordinates in the Transformation Editor dialog (described in Tool Positions...Cursor Mode below).

Access: Main Menu > Tools > Cursor  
or Desktop > Cursor

(see [Section 8.1, Part Mode](#) and [How to Use the Cursor \(Point\) Tool](#))

### *Line Tool Toggle*

Makes the Line Tool visible/invisible in the Graphics Window. The Line Tool appears as a white line with a cross at the center point and an arrowhead on its 2nd endpoint. The Line Tool is initially centered about the Look-At point and sized so that it fills approximately 10% of the default view. You can change its length and orientation interactively in the Graphics Window by selecting one of its end points. You can reposition it interactively in the Graphics Window by selecting its center and dragging it or by selecting Pick Line Location from the Pick Pull-down Icon menu in the Quick Desktop Button region. Alternatively, you can reposition it precisely by specifying coordinates in the Transformation Editor dialog (described in Tool Positions...Line Mode below).

Access: Main Menu > Tools > Line  
or Desktop > Line

(see [Section 8.1, Part Mode](#) and [How to Use the Line Tool](#))

#### Plane Tool

Makes the Plane Tool visible/invisible in the Graphics Window. (*Note: Its appearance (line or filled) is controlled under Main Menu > Edit > Preferences > View*)

The Plane Tool is shown with an X, Y, Z axis system, is initially centered about the Look-At point, and lies in the X-Y plane. You can reposition it interactively in the Graphics Window by selecting its center point in the Graphics Window and dragging it or by selecting Pick Plane Location from the Pick Pull-down Icon menu in the Quick Desktop Button region. Alternatively, you can reposition it precisely by specifying coordinates in the Transformation Editor dialog (described in Tool Positions... Plane Mode below). You can change its orientation interactively in the Graphics Window by selecting the X, Y, or Z letters at the ends of the axes. You can resize the Plane Tool interactively in the Graphics Window by selecting the corner or the plane between the ends of the X and Y axes.

Access: Main Menu > Tools > Plane  
or Desktop > Plane

(see [Section 8.1, Part Mode](#) and [How to Use the Plane Tool](#))

#### Box Tool

Makes the Box Tool visible/invisible in the Graphics Window. The Box Tool is shown with an X, Y, Z axis system and is initially centered about the Look-At point. You can resize it interactively in the Graphics Window by selecting any of its corner points and dragging. You can reposition it interactively in the graphics window by selecting the origin of the box and dragging. You can perform these types of operations as well as rotations, in the Transformation Editor dialog (described in Tool Positions... Box Mode below). You can even reposition it precisely by specifying coordinates in the Transformation Editor dialog.

Access: Main Menu > Tools > Box

(see [Section 8.1, Part Mode](#) and [How to Use the Box Tool](#))

#### Quadric

Opens a pull-down menu which allows you to choose one of the Quadric Tools and make it visible.

Access: Main Menu > Tools > Quadric

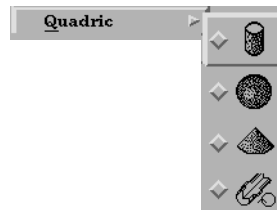

Figure 6-15  
Quadric Tool pull-down menu

#### Cylinder Tool Toggle

Makes the Cylinder Tool visible/invisible in the Graphics Window. The Cylinder Tool appears as thick direction line with center point and a circle around the line at the mid and two end points. Thinner projection lines run parallel to the direction line through the three circles outlining the surface of the cylinder. The Cylinder Tool is initially centered about the Look-At point with the direction line pointing in the X direction. You can change its length and orientation interactively in the Graphics Window by selecting one of its end points. You can change its diameter by selecting the circle about the mid point. You can reposition it interactively in the Graphics Window by selecting its center or alternatively, you can reposition it precisely by specifying coordinates in the Transformation Editor dialog (described in Tool Positions... Quadric below).

Access: Main Menu > Tools > Quadric

(see [How to Use the Cylinder Tool](#))

#### Sphere Tool Toggle

Makes the Sphere Tool visible/invisible in the Graphics Window. The Sphere Tool appears as thick direction line with several circles outlining the sphere. The Sphere Tool is



initially centered about the Look-At point with the direction line pointing in the X direction. You can change its radius and orientation interactively in the Graphics Window by selecting one of the thick direction line end points. You can reposition it interactively in the Graphics Window by selecting its center or alternatively, you can reposition it precisely by specifying coordinates in the Transformation Editor dialog (described in Tool Positions... Quadric below).

Access: Main Menu > Tools > Quadric

(see [How to Use the Sphere Tool](#))

#### Cone Tool Toggle

Makes the Cone Tool visible/invisible in the Graphics Window. The Cone Tool appears as thick direction line with a circle at the end point. Thinner projection lines run from the beginning point to the circle at the end point outlining the surface of the cone. The Cone Tool is initially centered about the Look-At point with the direction line pointing in the X direction. You can change its length and orientation interactively in the Graphics Window by selecting one of the thick direction line end points. You can change its diameter by selecting the largest circle about the end point. You can reposition it interactively in the Graphics Window by selecting its center or alternatively, you can reposition it precisely by specifying coordinates in the Transformation Editor dialog (described in Tool Positions... Quadric below). The cone tool always operates as if the tool extends infinitely from the origin at the half angle. The half angle of the cone tool is in degrees.

Access: Main Menu > Tools > Quadric

(see [How to Use the Cone Tool](#))

#### Revolution Tool Toggle

Makes the Surface of Revolution Tool visible/invisible in the Graphics Window. The Revolution Tool appears as thick direction line with several circles outlining each user defined point along the tool. Thinner projection lines run through the circles to outline the revolution surface. The Revolution Tool is initially centered about the Look-At point with the direction line pointing in the X direction. You can change its length and orientation interactively in the Graphics Window by selecting one of the thick direction line end points. You can reposition it interactively in the Graphics Window by selecting its center or alternatively, you can reposition it precisely by specifying coordinates in the Transformation Editor dialog (described in Tool Positions... Quadric below).

Access: Main Menu > Tools > Quadric

(see [How to Use the Surface of Revolution Tool](#))

*Tool positions...*

Opens the Transformation Editor dialog which allows you to precisely position the various tools within the Graphics Window in reference to the selected Frame.

Access: Main Menu > Tools > Tool Positions...

*Region Tool  
(Selection region)*

Click on Editor Function in the Transformation Editor dialog and then selecting Tools > Select region from the pull-down menu configures the dialog as shown below:



Figure 6-16  
Transformation Editor (Select region)

To precisely position the Selection tool, enter the desired normalized screen coordinate values for X and Y minimum and maximum. The coordinates can be between 0.0 and 1.0.

Access: Main Menu > Tools > Tool Positions... > Tools > Select region

*Cursor Tool*

Clicking on Editor Function in the Transformation Editor dialog and then selecting Tools > Cursor from the pull-down menu configures the dialog as shown below.

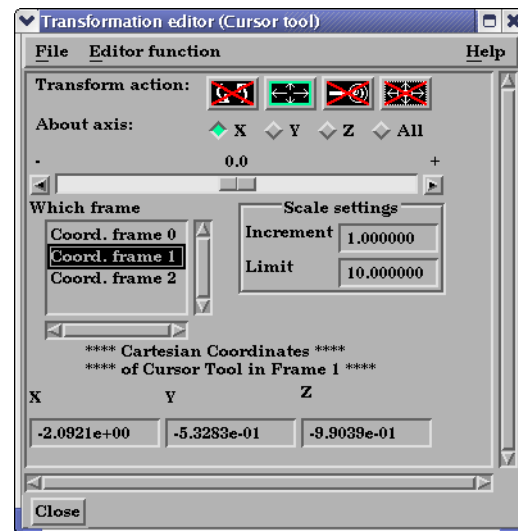

Figure 6-17  
Transformation Editor (Cursor)

The Transformation Editor dialog provides three methods for the precise positioning of the Cursor Tool. First, the Cursor Tool may be positioned within the Graphics Window by entering coordinates in the X, Y, and Z fields. Pressing return causes the Cursor Tool to relocate to the specified coordinates in the selected Frame (or, if more than one Frame is selected, for Frame 0).

It is also possible to reposition the Cursor Tool from its present coordinate position by specific increments. The Axis Button allows you to choose the axis of translation (X, Y, Z, or All). The Slider Bar at Top allows you to quickly choose the increment by which to move the position of the Cursor Tool. Dragging the slider in the negative (left) or positive

(right) directions and then releasing it will cause the X, Y, and Z coordinate fields to increment as specified and the Cursor Tool to relocate to the new coordinates. The number specified in the Limit field of the Scale Settings area determines the negative (-) and positive (+) range of the slider. If the Limit is set to 1.0 as shown, then the numerical range of the slider bar will be -1 to +1.

Alternatively, you can specify an increment for translation in the Increment field of the Scale Settings area. Pressing return while the mouse pointer is in the Increment field will cause the Cursor Tool to translate along the specified axis (or all axes) by the increment specified.

Access: Transformation Editor > Editor Function > Tools > Cursor

(see [How to Use the Cursor \(Point\) Tool](#))

## Line Tool

Clicking on Editor Function in the Transformation Editor dialog and then selecting Tools > Line from the pull-down menu configures the dialog as shown below.

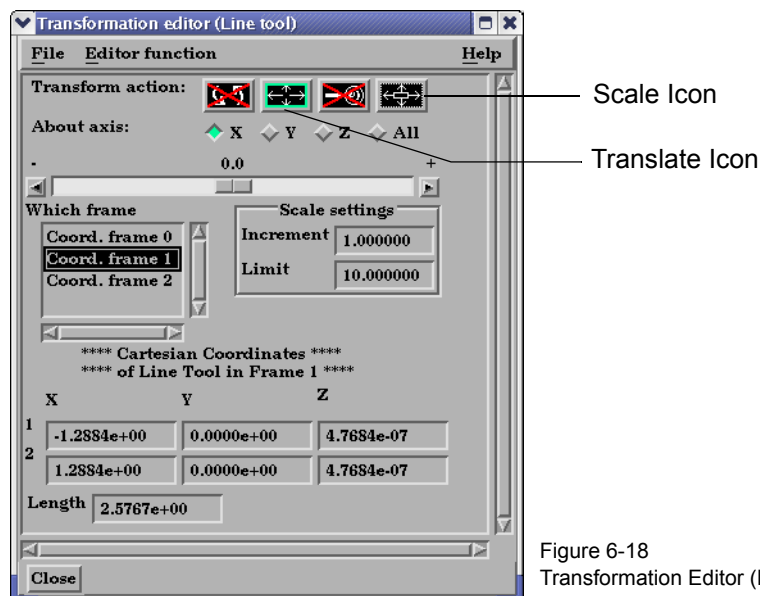

Figure 6-18  
Transformation Editor (Line Tool)

The Transformation Editor can control precisely the position and size of the line tool.

### Position

The Transformation Editor dialog provides three methods for the precise positioning of the Line Tool. First, the Line Tool may be positioned within the Graphics Window by entering coordinates for the two endpoints in the X, Y, and Z fields. Pressing return causes the Line Tool to relocate to the specified coordinates in the selected Frame (or if more than one Frame is selected, in Frame 0).

It is also possible to reposition the Line Tool from its present coordinate position by specific increments. First click on the translate icon. The Axis Button allows you to choose the axis of translation for the center of the line (X, Y, Z, or All). The Slider Bar at Top allows you to quickly choose the increment by which to move the position of the center point of the Line Tool. Dragging the slider in the negative (left) or positive (right) directions and then releasing it will cause the X, Y, and Z coordinate fields to increment as specified and the Line Tool to relocate to the new coordinates. The number specified in the Limit field of the Scale Settings area determines the negative (-) and positive (+) range of the slider. If the Limit is set to 1.0 as shown, then the numerical range of the slider bar will be -1 to +1.

Alternatively, you can specify an increment for translation in the Increment field of the Scale Settings area. Pressing return while the mouse pointer is in the Increment field will cause the center point of the Line Tool to translate along the specified axis (or all axes) by the increment specified.

Scale

First click on the scale icon. Next pick an increment and limit and slide the slider to scale the line about its center, along its length.

Access: Transformation Editor > Editor Function > Tools > Line

(see [How to Use the Line Tool](#))

## Plane Tool

Clicking on Editor Function in the Transformation Editor dialog and then selecting Tools > Plane from the pull-down menu configures the dialog as shown below.

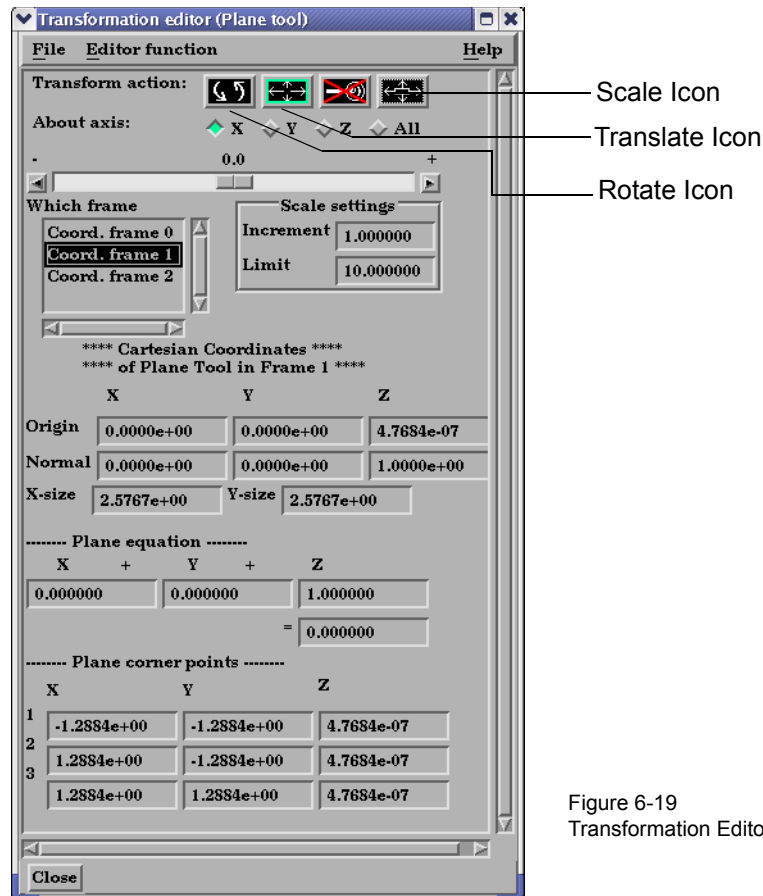

Figure 6-19  
Transformation Editor (Plane Tool)

The Transformation Editor can control precisely the position, orientation, and size of the plane tool.

Position

The Transformation Editor dialog provides four methods for the precise positioning of the Plane Tool. First, the Plane Tool may be positioned within the Graphics Window by entering coordinates for the three corners of the plane in the X, Y, and Z fields. Corner 1 is defined as the -X, -Y corner of the plane, Corner 2 is defined as the +X, -Y corner of the plane, and Corner 3 is defined as the +X, +Y corner of the plane. Pressing return causes the Line Tool to relocate to the specified coordinates in the selected Frame (or if more than one Frame is selected, in Frame 0).

You can also position the Plane Tool by entering a plane equation in the form  $A_x + B_y + C_z = D$  in the X+Y+Z fields and then pressing Return. The coefficients of the plane equation are in reference to the selected Frame (or if more than one Frame is selected, to Frame 0).

As with the Cursor and Line Tools, it is possible to reposition the Plane Tool from its present coordinate position by specific increments. First click the translate icon at the top of the Transformation Editor. The Axis Button allows you to choose the axis of translation (X, Y, Z, or All) for the origin of the Plane Tool (intersection of the axes). The Slider Bar at Top allows you to quickly choose the increment by which to move the position of the origin. Dragging the slider in the negative (left) or positive (right)

directions and then releasing it will cause the X, Y, and Z coordinate fields to increment as specified and the origin of the Plane Tool to relocate to the new coordinates. The number specified in the Limit field of the Scale Settings area determines the negative (-) and positive (+) range of the slider. If the Limit is set to 1.0 as shown, then the numerical range of the slider bar will be -1 to +1.

Alternatively, you can specify an increment for translation in the Increment field of the Scale Settings area. Pressing return while the mouse pointer is in the Increment field will cause the center of the Plane Tool to translate along the specified axis (or all axes) by the increment specified.

**Orientation** First click on the rotate icon. Next, pick an axis about which to rotate. Next pick an increment and limit (in degrees) and slide the slider to rotate the plane.

**Scale** First click on the scale icon. Next pick an axis direction to scale (X or Y only). Finally pick an increment and limit and slide the slider to scale the size of the plane.

Access: Transformation Editor > Editor Function > Tools > Plane

(see [How to Use the Plane Tool](#))

#### Box Tool

Clicking on Editor Function in the Transformation Editor dialog and then selecting Tools > Box from the pull-down menu configures the dialog as shown below.

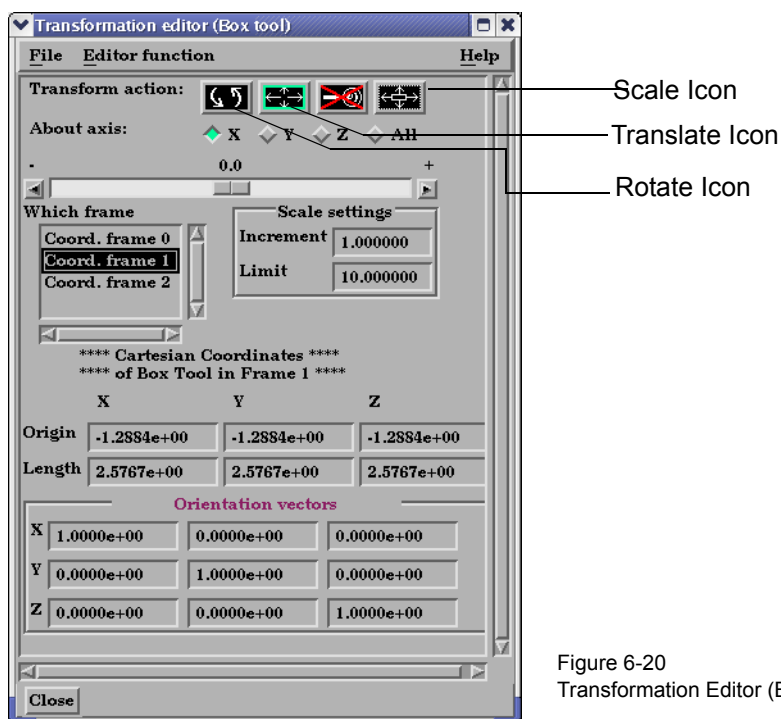

Figure 6-20  
Transformation Editor (Box Tool)

The Transformation Editor can control precisely the position, orientation, and size of the box tool.

**Position** The Transformation Editor dialog provides several methods for the precise positioning of the Box Tool. First, the Box Tool may be positioned within the Graphics Window by entering coordinates for the origin of the box in the X, Y, and Z fields and the length of the each of the X, Y, and Z sides. Pressing return causes the Box Tool to relocate to the specified location in the selected Frame (or if more than one Frame is selected, in Frame 0).

Additionally, you can modify the orientation of the Box Tool by entering the X, Y, and Z orientation vectors of the box axis in regards to Frame 0.

As with other Tools, it is possible to reposition the Box Tool from its present coordinate position by specific increments. First click the translate icon at the top of the Transformation Editor. The Axis Button allows you to choose the axis of translation (X,

Y, Z, or All) for the origin of the Box Tool (intersection of the axes). The Slider Bar at Top allows you to quickly choose the increment by which to move the position of the origin. Dragging the slider in the negative (left) or positive (right) directions and then releasing it will cause the X, Y, and Z coordinate fields to increment as specified and the origin of the Box Tool to relocate to the new coordinates. The number specified in the Limit field of the Scale Settings area determines the negative (-) and positive (+) range of the slider. If the Limit is set to 1.0 as shown, then the numerical range of the slider bar will be -1 to +1.

Alternatively, you can specify an increment for translation in the Increment field of the Scale Settings area. Pressing return while the mouse pointer is in the Increment field will cause the origin of the Box Tool to translate along the specified axis (or all axes) by the increment specified.

**Orientation** First click on the rotate icon. Next, pick an axis about which to rotate. Next pick an increment and limit (in degrees) and slide the slider to rotate the Box Tool.

**Scale** First click on the scale icon. Next pick an axis direction to scale. Finally pick an increment and limit and slide the slider to scale the size of the Box Tool.

Access: Transformation Editor > Editor Function > Tools > Box

(see [How to Use the Box Tool](#))

Cylinder or Sphere  
Tools

Clicking on Editor Function in the Transformation Editor dialog and then selecting Tools and then Cylinder or Sphere from the pull-down menu configures the dialog as shown below.

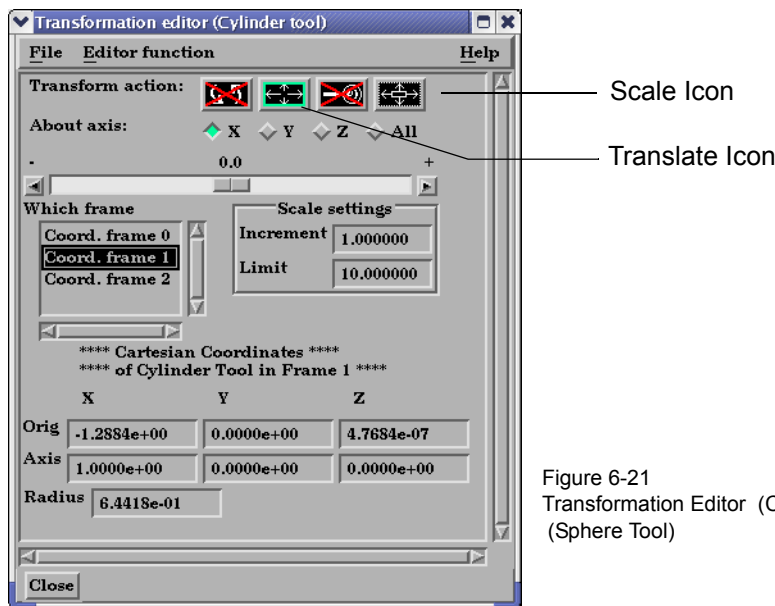

Figure 6-21  
Transformation Editor (Cylinder Tool) or  
(Sphere Tool)

The Transformation Editor can control precisely the position and size of the cylinder tool.

**Position** The Transformation Editor dialog enables you to precisely control the coordinates of the Cylinder or Sphere Tool origin (center point of the thick direction line) by specifying them in the Orig. X, Y, and Z fields. You control the direction vector for the Cylinder or Sphere Tool direction axes by specifying the coordinates in the Axis X, Y, and Z fields of the selected Frame (or if more than one Frame is selected, in Frame 0). The Radius of each tool may be specified in the Radius Field.

It is possible to reposition the Cylinder or Sphere Tool origins by specific increments. First click on the translate icon. The Axis Button allows you to choose the axis of translation (X, Y, Z, or All) for the origin of the tool. The Slider Bar at Top allows you to quickly choose the increment by which to move the position of the origin. Dragging the slider in the negative (left) or positive (right) directions and then releasing it will cause the X, Y, and Z coordinate fields to increment as specified and the origin of the Cylinder or Sphere

Tool to relocate to the new coordinates. The number specified in the Limit field of the Scale Settings area determines the negative (-) and positive (+) range of the slider. If the Limit is set to 1.0 as shown, then the numerical range of the slider bar will be -1 to +1.

Alternatively, you can specify an increment for translation in the Increment field of the Scale Settings area. Pressing return while the mouse pointer is in the Increment field will cause the origin of the Cylinder or Sphere Tool to translate along the specified axis (or all axes) by the increment specified.

### Scale

First click on the scale icon. Next pick an axis direction to scale. Can only scale in the X (longitudinal) or Y (radial) directions. Finally pick an increment and limit and slide the slider to scale the size of the cylinder or sphere Tool.

Access: Transformation Editor > Editor Function > Tools > Cylinder or Sphere

(see [How To Use the Cylinder Tool](#) and [How To use the Sphere Tool](#))

### Cone Tool

Clicking on Editor Function in the Transformation Editor dialog and then selecting Tools and then Cone from the pull-down menus configures the dialog as shown below.

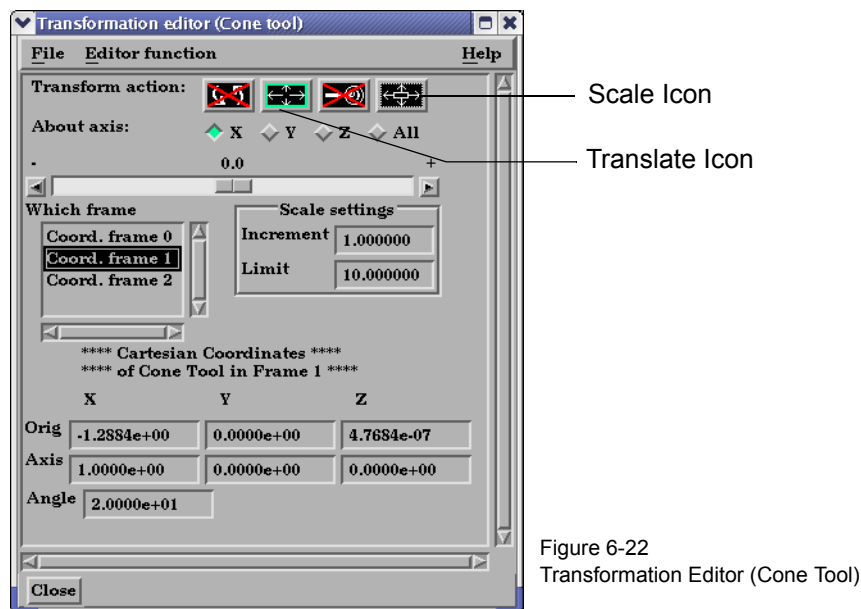

Figure 6-22  
Transformation Editor (Cone Tool)

The Transformation Editor dialog enables you to precisely control the coordinates of the Cone Tool origin (the point of the cone) by specifying them in the Orig. X, Y, and Z fields. You control the direction vector for the Cone Tool direction axis by specifying the coordinates in the Axis X, Y, and Z fields for the selected Frame (or if more than one Frame is selected, in Frame 0). The conical half angle may be specified in degrees in the Angle Field.

### Position

It is possible to reposition the Cone Tool origin by specific increments. The Axis Button allows you to choose the axis of translation (X, Y, Z, or All) for the origin of the tool. The Slider Bar at Top allows you to quickly choose the increment by which to move the position of the origin. Dragging the slider in the negative (left) or positive (right) directions and then releasing it will cause the X, Y, and Z coordinate fields to increment as specified and the origin of the Cone Tool to relocate to the new coordinates. The number specified in the Limit field of the Scale Settings area determines the negative (-) and positive (+) range of the slider. If the Limit is set to 1.0 as shown, then the numerical range of the slider bar will be -1 to +1.

Alternatively, you can specify an increment for translation in the Increment field of the Scale Settings area. Pressing return while the mouse pointer is in the Increment field will cause the center of the Cone Tool to translate along the specified axis (or all axes) by the increment specified.

Scale

First click on the scale icon. Next pick an axis direction to scale. Can only scale in the X (longitudinal) or Y (half conical angle) directions. Finally pick an increment and limit and slide the slider to scale the size of the cone tool.

Access: Transformation Editor > Editor Function > Tools > Cone

(see [How to Use the Cone Tool](#))

## Revolution Tool

Clicking on Editor Function in the Transformation Editor dialog and then selecting Tools and then Revolution from the pull-down menu configures the dialog as shown below.

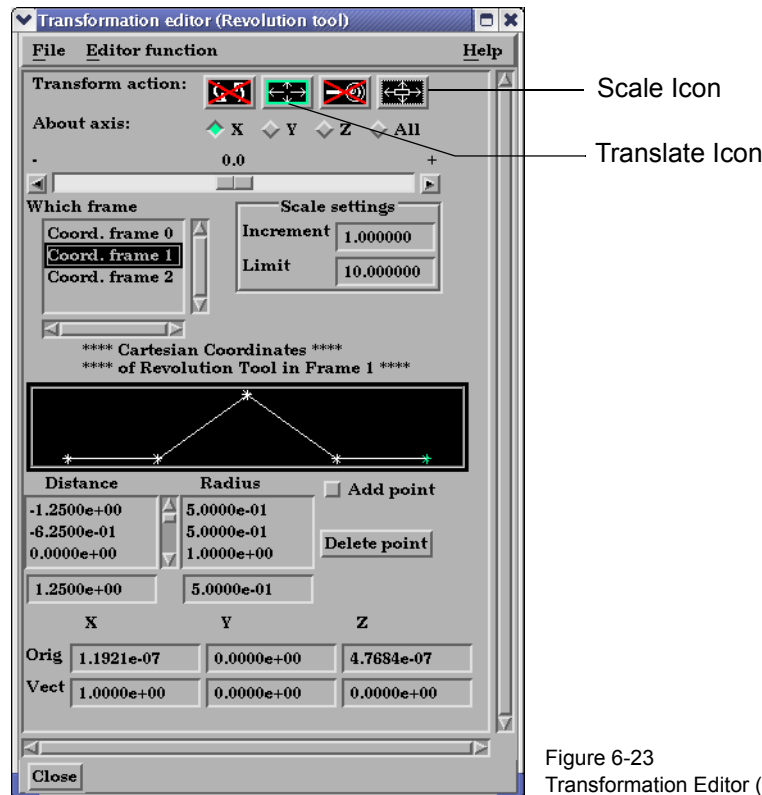

Figure 6-23  
Transformation Editor (Revolution Tool)

For the Revolution Tool, you not only control the origin and direction vector, but the number of points and positions that are revolved about the axis. The desired coordinates of the Revolution Tool origin (center point of the thick direction line) are specified in the Orig. X, Y, and Z fields. The direction vector for the Revolution Tool direction axis is specified by entering the desired coordinates in the Vect X, Y, and Z fields for the selected Frame (or if more than one Frame is selected, in Frame 0).

Additional points may be added to the Revolution Tool by clicking on the Add Point(s) toggle and then clicking at the desired location in the schematic for the tool. There is no need to be overly precise in its placement since its location can be modified. Once you have added all of the new points you wish, the Add Point(s) toggle should be turned off. A point may be deleted by selecting it in the schematic area and then clicking the Delete button.

The position of any point may be modified interactively within the Revolution Tool schematic window. Simply click on and drag the point to the desired location. The precise location of any point may be specified by selecting the point in the schematic with the mouse and then entering the desired Distance (from the Revolution Tool origin) or Radius (from the axis) for the point in the text entry fields beneath the Distance and Radius Lists. Pressing return will enter the new value in the list above for the selected point.

The Transformation Editor can control precisely the position and size of the revolution tool.



**Position** It is possible to reposition the Revolution Tool origin by specific increments. First click on the translate icon. The Axis Button allows you to choose the axis of translation (X, Y, Z, or All) for the origin of the tool. The Slider Bar at Top allows you to quickly choose the increment by which to move the position of the origin. Dragging the slider in the negative (left) or positive (right) directions and then releasing it will cause the X, Y, and Z coordinate fields to increment as specified and the origin of the Revolution Tool to relocate to the new coordinates. The number specified in the Limit field of the Scale Settings area determines the negative (-) and positive (+) range of the slider. If the Limit is set to 1.0 as shown, then the numerical range of the slider bar will be -1 to +1.

Alternatively, you can specify an increment for translation in the Increment field of the Scale Settings area. Pressing return while the mouse pointer is in the Increment field will cause the center of the Revolution Tool to translate along the specified axis (or all axes) by the increment specified.

**Scale** First click on the scale icon. Next pick an axis direction to scale. Can only scale in the X (longitudinal) or Y (radial) directions. Finally pick an increment and limit and slide the slider to scale the size of the revolution tool.

**Redraw** This button will cause the Revolution Tool schematic window to re-center to the currently defined points of the tool.

Access: Transformation Editor > Editor Function > Tools > Revolution  
(see [How to Use the Surface of Revolution Tool](#))

## 6.6 Case Menu Functions

EnSight allows you to work concurrently with up to sixteen different sets of results data (computational or experimental). Each set of results data is read in as a “Case”.

Clicking the Case button in the Main Menu opens a pull-down menu which provides access to the following features:

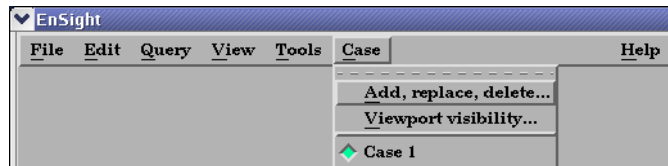

Figure 6-24  
Case pull-down menu

*Add, replace, delete...* Opens the File Selection dialog.

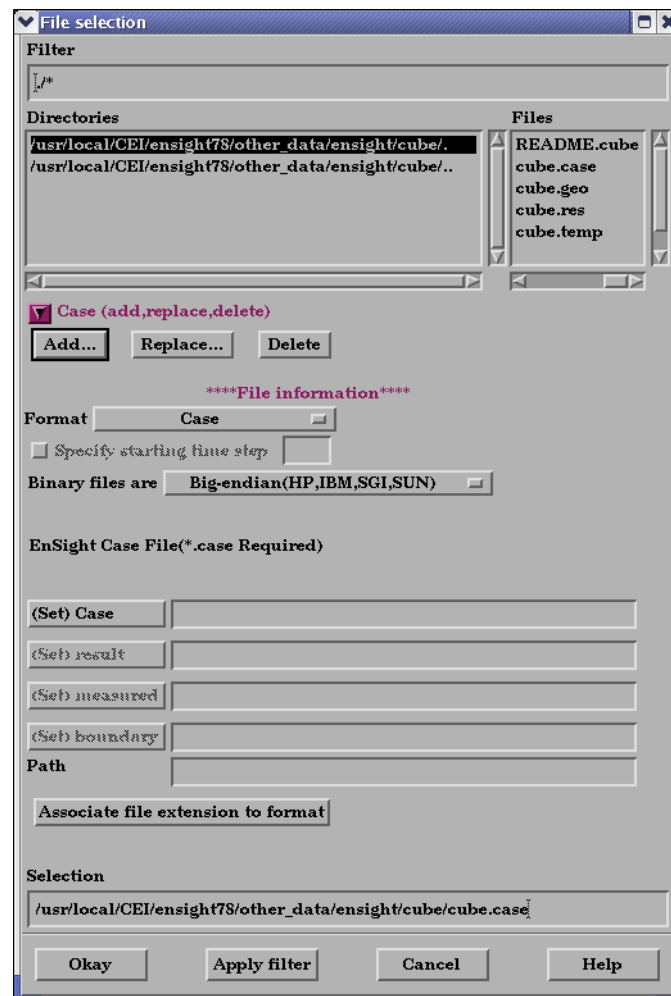

Figure 6-25  
File Selection Dialog to Add, Replace or Delete a Case

Case Turndown Button

Add... Opens a dialog which allows you to specify a name and other options for the new Case.

The name will appear in the list of active Cases at the bottom of the Main Menu: Case pull-down menu as shown in Figure 6-24 above. Adding a Case actually starts a new EnSight Server and connects it to the EnSight Client. You then read and load data files for the new Case and the data will be added to the data already present in the EnSight Client.

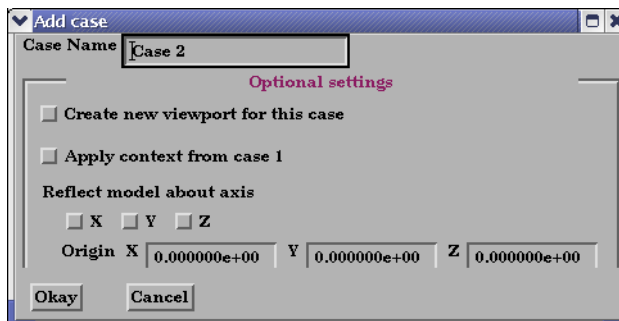

Figure 6-26  
Add Case Dialog

When adding a case, you can have some options. The new case can be placed in a new viewport or added to the current. It can have the context of case 1 applied to it, which will cause it to basically inherit the positioning etc. of case 1. And you can even reflect the new case about any of the major axes and specify the origin as it is read.

Replace...

Replacing a Case causes all parts and variables associated with the active Case to be deleted. The Server will be restarted and assigned the new Case name. Clicking the Replace... button opens a small dialog which allows you to specify a name for the Case you wish to use to replace the Case currently selected in the Main Menu: Case pull-down menu as shown in Figure 6-24 above. You then read and load data for the new Case.

Delete

Deleting a Case causes all parts and variables associated with the Case to be deleted and terminates the Server associated with the Case. Clicking the Delete button opens a Warning Dialog which asks you to confirm that you wish to delete the Case currently selected in the Main Menu: Case pull-down menu as shown in Figure 6-24 above.

(see [How To Load Multiple Datasets \(Cases\)](#))

Viewport visibility...

Opens the Case visible in which viewport dialog which allows you to specify in which Viewports (including the Main Graphics Window) you wish to make the parts associated with the currently selected Case visible. Parts associated with the selected Case will be visible in the viewports outlined in green and invisible in those outlined in red. Visibility for specific Parts can of course be toggled on/off using the Part Visibility Icon in the Part Mode Icon Bar.

(see Part Visibility Toggle Icon in [Section 8.1, Part Mode](#))

Finally, at the bottom of the pull-down menu you will find a list of active Cases, The toggle buttons allow the selection of only one Case at a time. In Figure 6-24 above, Case 1 is the currently selected Case. The current selected Case is the one which will be affected by the Data Reader, Querys, and many other operations.

## 6.7 Help Menu Functions

Clicking the Help button in the Main Menu opens a pull-down menu which provides access to the following features:

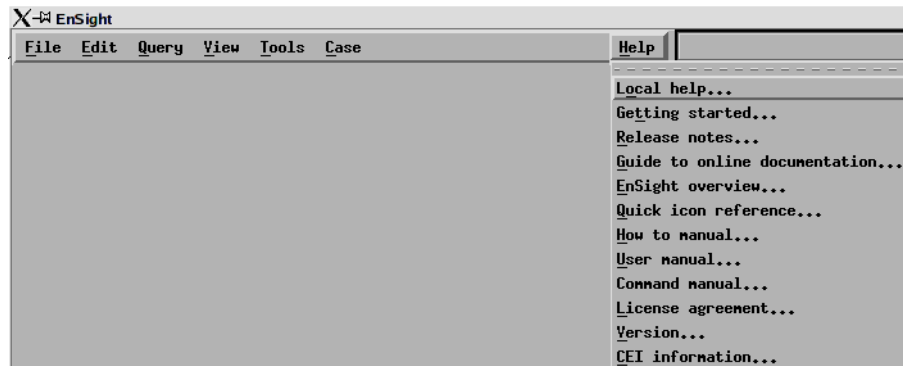

Figure 6-27  
Help pull-down menu

<i>Local help...</i>	Opens a site-specific, optional, local help document (if one exists). Simply place a .pdf file in your \$CEI_HOME/ensight80/site_preferences directory named "LocalHelp.pdf".
<i>Getting started...</i>	Opens the Getting Started Manual on-line. <i>Note that this document is not cross-referenced within itself or to other documents.</i>
<i>Release notes...</i>	Provides an overview of changes made since the last major EnSight release.
<i>Guide to online documentation...</i>	Provides a <a href="#">guide</a> to the use of the On-Line Documentation.
<i>EnSight overview...</i>	Provides an <a href="#">overview</a> of EnSight.
<i>Quick icon reference...</i>	Provides a <a href="#">quick reference guide</a> to all EnSight GUI icons, many of which have links to appropriate How To documents
<i>How to manual...</i>	Opens the <a href="#">How To Manual</a> on-line.
<i>User manual...</i>	Opens the <a href="#">User Manual</a> on-line.
<i>Command manual...</i>	Opens the <a href="#">Command Language Manual</a> on-line.
<i>Local Help...</i>	Opens a pdf document entitled "local_help.pdf" which is located as follows: \$CEI_HOME/ensight80/site_preferences. This is a hook for a sites that want to provide site-specific help for their users. This might include customized preferences, help manuals for local User-Defined Readers, instructions for using customized macros, etc.
<i>License agreement...</i>	Opens up On-Line Documentation to the text of the <a href="#">EnSight End User License Agreement and the EnSight Support and Maintenance Service Agreement</a> .
<i>Version...</i>	Opens up the Version Information dialog which states the version number of the EnSight software currently running.
<i>CEI information...</i>	Opens up the CEI Information display which gives full CEI contact information.

# 7 Features

This chapter describes the functions available through the Feature Icon Bar.



Figure 7-1  
EnSight Feature Icon Bar

**Section 7.1, Solution Time**

**Section 7.2, Flipbook Animation**

**Section 7.3, Keyframe Animation**

**Section 7.4, Variable Calculator**

**Section 7.5, Query/Plot**

**Section 7.6, Interactive Probe Query**

**Section 7.7, Contour Create/Update**

**Section 7.8, Isosurface Create/Update**

**Section 7.9, Clip Create/Update**

**Section 7.10, Vector Arrow Create/Update**

**Section 7.11, Particle Trace Create/Update**

**Section 7.12, Subset Parts Create/Update**

**Section 7.13, Profile Create/Update**

**Section 7.14, Elevated Surface Create/Update**

**Section 7.15, Vortex Core Create/Update**

**Section 7.16, Shock Surface/Region Create/Update**

**Section 7.17, Separation/Attachment Lines Create/Update**

**Section 7.18, Boundary Layer Variables Create/Update**

**Section 7.19, Material Parts Create/Update**

**Section 7.20, Developed Surface Create/Update**

**Section 7.21, Tensor Glyph Parts Create/Update**

## 7.1 Solution Time

Many analyses contain time dependent information, such as automobile crash simulations and unsteady flow problems. The presence of time-dependent data is indicated to EnSight through an EnSight result file, case file, or is determined directly from the data files of other formats. EnSight has the capability of displaying the model and results at any time provided for in the data. Linear interpolation between given time steps is possible as long as the geometry does not have changing connectivity over time.

EnSight keeps track of which variables and Parts have been created so that if you change time steps, variables and Parts will update appropriately. For example, assume you have created a clip plane through the combustion chamber of an engine. From this clip plane you have created two constant variables Min Temperature and Max Temperature and are displaying them in the Main View. Now change time steps. First, the geometry updates to a new crank angle position. Second, the clip plane will automatically be recalculated to fit the new geometry. Third, the Min and Max values displayed in the Graphics Window are recalculated and updated. This is all performed automatically by EnSight after you change the current time value.

It is important to distinguish between time step and solution time. An example will best illustrate this concept.

Consider a model with data for 5 different times:

Time Step	Solution Time
0	1.0125
1	11.025
2	11.50
3	13.00
4	21.333

Note that the time steps coincide with the number of transient data files and are integers. The solution time at each time step comes from the analysis, and does not have to be at uniform intervals. The solution time can be in any units needed, but must be consistent with the solution files. That is, if a velocity file was in terms of meters per second, then the solution time must be in terms of seconds. Hence it is not possible, for example, to have the solution time reported in degrees crank angle for a combustion case unless the corresponding solution files were also in terms of crank angle (otherwise velocity would be reported in the meaningless units of meters-per-degree-crank-angle).

The Solution time must *always* be increasing in time at the resolution of single precision variable. Failure to follow this rule will result in an error.

A special Solution Time dialog gives you control over time and relates time step to solution time. You can force the time information to conform to the actual time data given at the steps, or you can allow interpolation to occur between time steps. You must be aware of the implications of such an interpolation and choose the method that is appropriate.

Also, you can see the ranges of time dependent data available and the current time that is set for the Main View. You can change time steps by either entering a new time to view, or using the Solution Time slider bar.

The Solution Time Dialog shows a composite timeline of all timesets from all cases. For any case, a number of different timesets can exist. Each timeset can be attached to multiple variables and/or geometry. This makes it possible to, for example, have one variable defined at  $t = 1.0, 2.0, 3.5$  and another variable defined at  $t = 1.5, 2.0, 4.0$ . For each timeline, controls exist to specify how EnSight should interpolate the variables when time is set to a value not defined for a given timeset.

There are other places within EnSight where time information is requested. These include, traces, emitters, animated traces, flip book transient data, key frame animation transient data, and Query/Plot. Each of these use the specified Beg/End values. For functions which do not explicitly specify the time step the current display time (as defined in the Solution Time Dialog) is used.

For data that is transient, the Solution Time Icon will be visible. For static data that does not change over time, there will be no Solution Time Icon on the Feature Icon Bar. Clicking once on the Solution Time Icon opens the Solution Time Editor in the Quick Interaction Area which is used to specify time information.



Figure 7-2  
Solution Time Icon

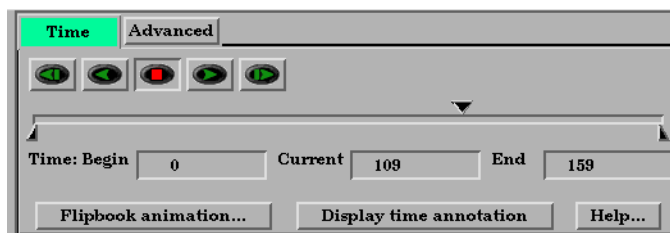

Figure 7-3  
Quick Interaction Area - Solution Time Editor

Record Button  
(Enabled with active animation playing)

The range of both Time Steps and Simulation Time is shown at the top of the Editor. The default Quick Interaction Area is the Time tab which is highlighted.

<i>Beg</i>	Value for Beginning Time Step or Simulation Time. The left slider below the rail can be used to select the beginning value.
<i>Cur</i>	Value for Current Time Step or Simulation Time. The slider above the rail can be used to select a value for the Current Time Step field.
<i>End</i>	Value for Ending Time Step or Simulation Time. The right slider below the rail can be used to select the ending value.
<i>Video Controls</i>	Click on the Video Playback control buttons to go back on timestep, to play in reverse, to stop, to play forward and to step forward one timestep, respectively. Note that this form of playing the animation is a solution time stream of the data. That is, each timestep is read from the data file without storing the animation in memory.
<i>Record Button</i>	Opens a dialog for recording transient animation to a file. This button is only enabled when an active animation is playing.
<i>Flipbook Animation...</i>	Opens the Flipbook Animation Editor. (see Section 7.2, Flipbook Animation)
<i>Display Time Annot</i>	Toggles an annotation in the graphics area of the Time value. Click on the Annot Tab to the left of the graphics area to move, modify, etc. this annotation.

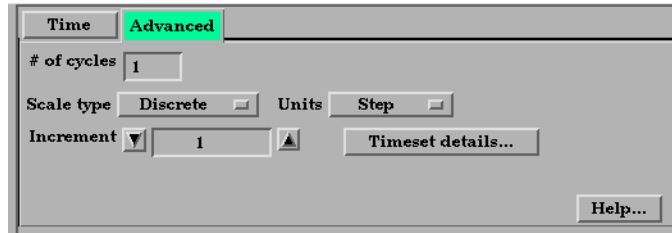

Figure 7-4  
Quick Interaction Area - Solution Time Editor

<i># of Cycles</i>	For cyclic transient analysis, the solution is often computed for one cycle only. It is often desirable to be able to visualize more than one cycle. This is possible only if the first and last timesteps contain the same information. By default, EnSight assumes one cycle.
<i>Scale Type</i>	Opens a pop-up menu to specify use of existing time steps, or allow EnSight to linearly interpolate to show any time step. Choices are: <ul style="list-style-type: none"> <li><i>Discrete</i>      Can only change time to defined steps.</li> <li><i>Continuous</i>      Can change time to any time, including times between steps. Only available if do not have changing geometry connectivity transient case.</li> </ul>
<i>Units</i>	Opens pop-up menu to specify whether to use and display: <ul style="list-style-type: none"> <li><i>Step</i>              which will be an integer showing time as step data. Will show NOSTEP if in <i>Continuous</i> mode and current time is not at a given time step. Current time will automatically change to keep within range Begin/End range. The default beginning and ending simulation times correspond to the first and last time steps specified in the results.</li> <li><i>Simulation Time</i>      which will be a real number showing true simulation time. Current time will automatically change to keep within the Begin/End range. The default beginning and ending simulation times correspond to the first and last times specified in the results.</li> </ul>
<i>Increment</i>	Specifies the incremental time which will be applied to the current time each time the slider stepper buttons are used.



*Timeset Details...* will open the Timeset Details dialog.

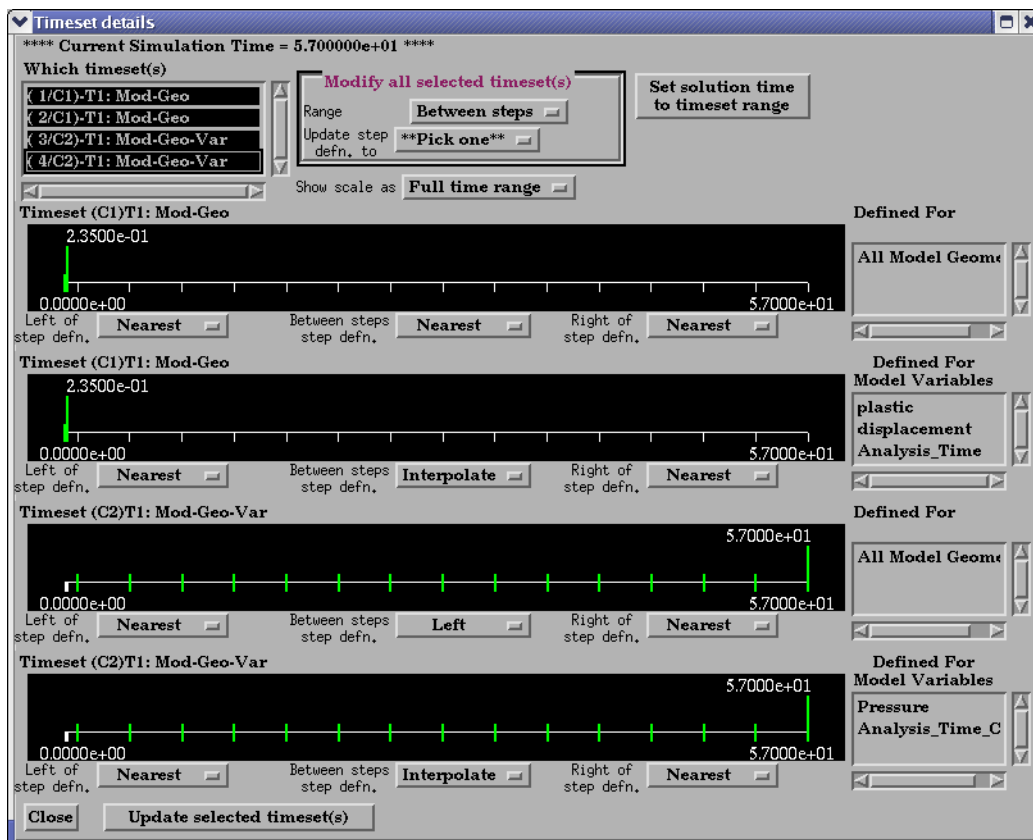

Figure 7-5  
Timeset Details Dialog

*Which Timeset(s)* Selects the timesets to be viewed.

*Modify All* Allows modification of all selected timesets.

*Selected Timeset(s)*

*Range* which time range to modify.

*Update Step Defn. To* Choose how to modify the selected Timeset's Range.

*Set Solution Time To Timeset Range* Will set the Solution Time Beg. and End. time values to correspond to the selected timeset.

*Show Scale As*

“Full Time Range” will show the Timeset's values in relation to the full composite timeline. “Timeset's Range” will adjust the beginning and ending boundaries of the graphic timeset to correspond to the begin and end values for the timeset. The change will not take effect until the “Update Selected Timeset(s)” button is pressed.

*Defined For*

Lists all of the variables and/or geometry attached to the Timeset.

*Left/Right of Step Defn.*

When the Current time is less than the Timeset's minimum time, the attached variables will use the Nearest values or become Undefined.

*Between Steps Step Defn.*

When the Current time is between the Timeset's minimum and maximum time values, but not defined, the attached variables will use the Right/ Left, Interpolate, or Nearest values, or become Undefined.

*Update Selected*

Must be selected in order to update any changed Timeset.

## 7.2 Flipbook Animation

There are four common animation techniques which are easily accomplished with Flipbook Animation. They are:

- animation of transient data, which can be any combination of scalar/vector variables, geometry, and discrete Particles
- animation of mode shapes based on a mode-shape displacement variable
- animation of a Part moving or changing value during animation, such as sweeping a 2D-Clip Plane or changing the value of an isosurface.
- animation applying a linear interpolation of a vector displacement field value factor from 0 to 1.

You can combine any of these techniques with the animation of Particle traces discussed in the previous Section 7.4.

The concept of a flipbook is similar to the stick figures you have probably seen in books where each page contains a picture. When you flip through the pages quickly you get the sense of motion. Flipbook animation stores a series of “pages” in Client memory which are then rapidly played back to create the illusion of motion. Pages can be loaded as *graphic images*, which may playback faster; or as *graphic objects*, which can be transformed after creating the flipbook, even while the flipbook is running.

For animation to be of interest, something must change from page to page. For *transient-data* flipbooks, you must have visualized something about the model that changes over time. For *mode-shape* flipbooks, you need to have set the displacement attributes of the Parts for which you want to see mode shapes (see Section 7.10 Displacement On Parts). For *created-data* flipbooks, you need to have used the Start/Stop utility or specified Animation delta values for the Parts.

The number of pages in the flipbook determines the length and smoothness of the animation. You directly or indirectly specify how many pages to create. While the Server performs the calculations, the Client stores the flipbook pages in memory. Just how many pages you can store depends on the amount of memory installed on your Client workstation. Your choice to load graphic images or graphic objects affects memory requirements, but the complexity of the model and the size of the Graphics Window determine which will use less memory in any particular situation.

You can control which original model Parts and created Parts will be updated for each time increment as the user chooses. This feature takes all dependencies into account. For example if an elevated surface was created from a 2D clip plane, the clip plane would be updated first and then the elevated surface based on the new clip. The ability to choose which Parts are or are not updated allows before and after type comparisons of a Part.

After creating the flipbook, options for displaying it include: running all or only a portion of it, adjusting the display speed, running under manual control or automatically, and running from the beginning or cycling back-and-forth between the two ends.

It is important to know that objects in the flipbook cannot be edited. If you wish to

change something in the flipbook, you must reload it. If you decide to regenerate a flipbook (after changing something), you can choose to discard all the old pages, or keep any old page with the same page number as a new page.

This is very useful when you first load every tenth frame then decide to load them all. EnSight will not have to reload every tenth frame that already exists. When you are done with a flipbook, remember to click Delete All Pages. This will free up memory for other uses.

*Flipbook vs. Keyframe* While you can implement any flipbook animation technique with keyframe animation (described in the next section), flipbook animation has three advantages. First, graphic-object-type flipbooks allow you to transform the model interactively to see from many viewpoints. Second, graphic-image-type flipbooks can be saved to a file and later replayed without having to have the dataset loaded, or even being connected to the Server. Third, the speed of display can be more interactive because the flipbook is in memory and can be flipped through automatically or stepped through manually.

Flipbook animation has a few disadvantages. First, you cannot change any Part attributes, except visibility and material properties, without regenerating the flipbook. Second, each page is stored in Client memory, which limits the number of pages and hence the duration of the animation.

Four Animation Techniques:

1. *Transient Data* Transient-data flipbooks have pages that correspond to particular solution times; i.e. step or simulation. You specify at which time value to start and stop the animation, and the time increment between each page. The time increment can be more than one solution-time value; this is useful in finding a range of interest or for a coarse review of the results. The increment can be a fraction, in which case the data for a page is interpolated from the two adjoining solution-time values.
2. *Mode Shapes* Mode-shape flipbooks are used to show primary modes of vibration for a structure. This is done by using a per node displacement, enabling the Part to vibrate. While you can use any vector variable for a displacement, to see actual mode shapes you need to have a Results-file vector variable corresponding to each mode shape you wish to visualize. Note that you can create copies of Parts and simultaneously display them with different mode-shape variables, or one at its original state and the other with displacement for comparison.  
  
The first page of a mode-shape flipbook shows the full displacement (as it is normally shown in the Graphics Window). The last page shows the full displacement in the opposite direction. The in-between pages show intermediate displacements in proportion to the cosine of the elapsed-time of the animation.
3. *Created Data* Created-data flipbooks animate the motion of 2D-Clips and Isosurfaces according to their animation attributes. This animation allows you to show clipping planes sweeping through a model or to show a range of Isosurface values. The first page shows the Part's location as it appears in the normal Graphics Window. On each subsequent page, each 2D-Clip is regenerated at the new location found by adding the animation-delta displacement to the 2D-Clip's location on the previous page. Also, each Isosurface is regenerated with a new iso-value found by adding the animation-delta increment to the iso-value of the previous page.
4. *Linear Load* Linear-loaded flipbooks are used to animate a displacement field of a part by linearly interpolating the displacement field from its zero to its maximum value.

The variable by which the part is colored also updates according to the linearly displaced values. Like Mode Shapes, this utilizes a per node displacement. The function can be applied to any static vector variable.

Clicking once on the Flipbook Animation Icon opens the Flipbook Animation Editor in the Quick Interaction Area.



Figure 7-6  
Flipbook Animation Icon

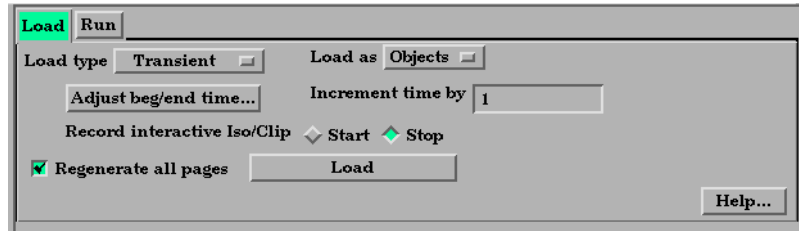

Figure 7-7  
Quick Interaction Area - Flipbook Animation Editor

#### Load Type

Opens a pop-up menu for the selection of type of flipbook animation to load. Options are:

- Transient* animates changes in data information resulting from changes in the transient data. For example, changes in coloration resulting from changes in variable values, or changes in displacement of Parts. See discussion in the introduction section.
- Mode Shapes* animates the mode shape resulting from a displacement variable. See discussion in the introduction of this section.
- Create Data* animates Parts having nonzero animation-delta values or which have been recorded with the Start/Stop utility. See discussion in the introduction of this section.
- Linear Load* animates the Displacement (vector) variable of a part by linearly interpolating the displacement field from its zero to its maximum value. The Color variables of the part also update according to the linearly displaced values.

#### Load As

Opens a pop-up menu for the selection of whether to load flipbook pages as Graphic Images or Graphic Objects.

- Graphic Objects* flipbooks enable you to transform objects after creating the flipbook. Playback performance depends on the complexity of the model.
- Graphic Images* flipbooks may be saved for later recall, but they cannot be transformed, nor can the window be resized. Playback performance depends on the Graphics Window size.

*Adjust Beg/End Time...* Opens the Solution Time Editor in the Quick Interaction Area. To return to the Flipbook Animation Editor from the Solution Time Editor, click on Animate Over Time... (When loading Transient data, the flipbook will start and stop at the Beg/End values specified in the Solution Time Editor.

(see Section 7.2, Flipbook Animation)

- Increment Time By** In this field you specify the increment of each transient-data flipbook page which corresponds to the range type specified in the Solution Time Editor,
- Note:* *If you enter a Begin, End, or Increment value not corresponding exactly to a Step or Simulation time value, EnSight will interpolate the values, affecting the appearance of each page (only if geometry connectivity is not changing).*
- Record Interactive Iso/Clip** Allows you to define the change (isovalue change or clip plane movement) in an isosurface or clip plane which will take place during the Flipbook load. Only isosurfaces and clip planes which are modified in interactive mode are tracked.
- Regen all pages** Toggling this on reloads all flipbook pages. Toggling it off saves load time if some pages have already been loaded, for example if you've just canceled the load, the pages already created during the load remain in memory. Also, you can quickly load by increment of 2 just to see if your animation looks good, then you can change the increment to 1, toggle off this toggle, and you'll only load the odd pages that have not yet loaded.
- Load** Clicking this button starts the loading flipbook pages and opens a pop-up dialog which reports the progress of the load and then closes to signal load is complete. If you cancel the load, the pages already created during the load remain in memory.
- Run Tab** Click on the Run tab at the top of the Flipbook quick interaction area to get the following dialog.

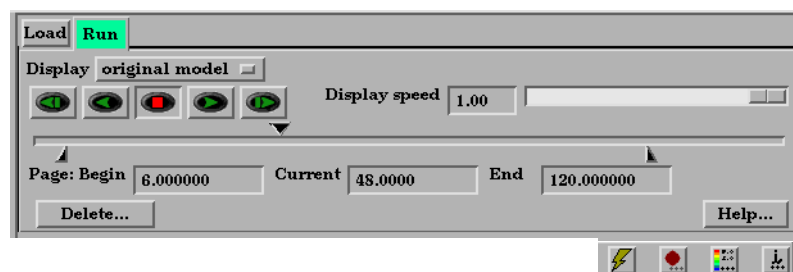

Figure 7-8  
Quick Interaction Area - Flipbook Animation Editor

Record Button

- Display** Opens a pop-up menu for selection and clarification of what is being viewed.  
*original model* - This is the original model.  
*flipbook pages* - These are the flipbook pages stored in memory.
- Video Controls** Click on the Video Playback control buttons to go back on timestep, to play in reverse, to stop, to play forward and to step forward one timestep, respectively.
- Display Speed** This field specifies the playback-speed factor. Varies from 1.0 (full speed of your hardware) to 0.0 (stopped). Change by entering a value or clicking the stepper buttons.
- Beg** Value for Beginning Time Step or Simulation Time. Type a value in the field, or the left slider below the rail can be used to select the beginning value.
- Cur** Value for Current Time Step or Simulation Time. Type a value in the field, or the slider above the rail can be used to select a value for the Current Time Step field.
- End** Value for Ending Time Step or Simulation Time. Type a value in the field or the right slider below the rail can be used to select the ending value.
- Delete...** Opens a pop-up warning dialog which asks you if you really wish to delete all loaded pages. Click Okay to delete all loaded flipbook pages and free the memory for other use.
- Record Button** In order to save an *active* flipbook animation, click on the record button found below the Quick Interaction Ar

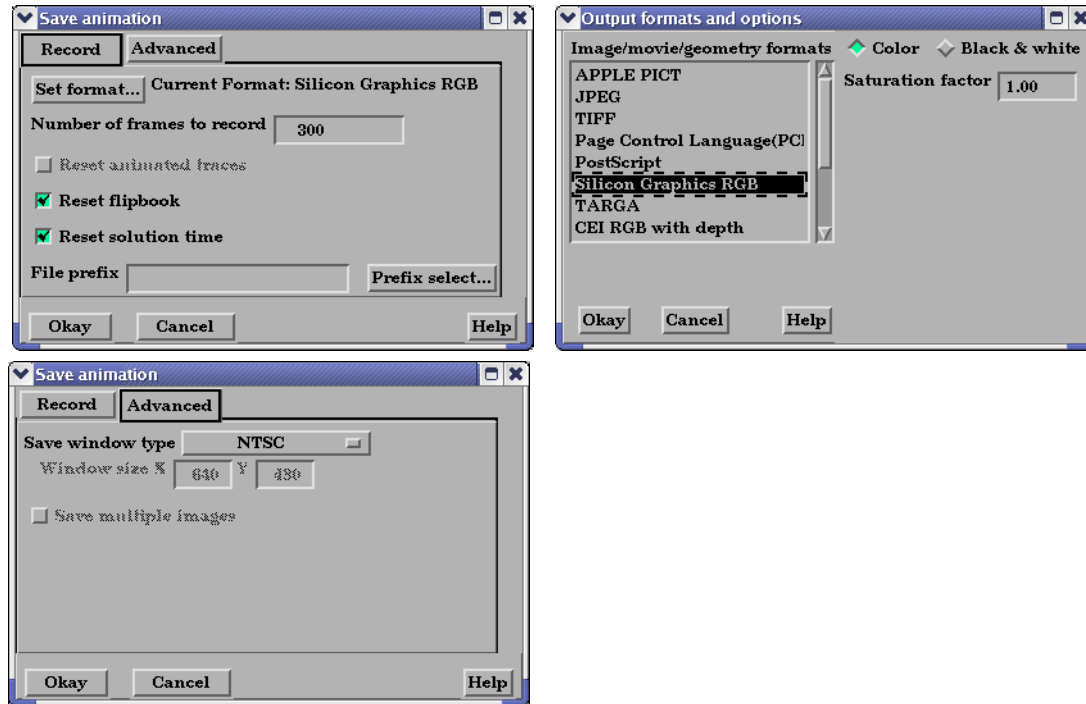

Figure 7-9  
Save Flipbook Pages To dialog

Record Tab	Click on the Record Tab (comes up by default in this mode when you click on the Record Button).
Set Format...	Brings up the Image/Movie Format and Options dialog. The flipbook will be recorded using the selected format. (see <a href="#">Section 2.11, Saving and Printing Graphic Images and How to Print/Save an Image</a> )
Number of frames	Choose the number of frames to record.
Reset Anim Traces	This will reset the animated traces to the beginning prior to starting the record. This toggle is only active if you have animated traces.
Reset Flipbook	This will reset the flipbook to the beginning prior to starting the record.
Reset Soln Time	This will reset the solution time to the beginning prior to starting the record.
File Prefix	The location and filename prefix for the recorded images. The appropriate suffix will be added automatically.

*Troubleshooting Flipbook Animation*

Problem	Probable Causes	Solutions
No motion	No pages are loaded.	Load flipbook pages.
	All pages are the same visually.	In order to see motion there must be a difference between one page and the next. Reload with differing Part attributes, such as coloring by a variable, using displacements, etc.
	Run Type set to Step or Off	Select Run Type to be Auto
Speed too fast	Display Speed is set too fast.	Change speed.
Speed too slow	Display Speed is set too slow.	Change speed.
	Hardware bottleneck (computer simply isn't sufficiently powerful)	Reduce the number of pages. Load pages as graphic images.
Speed erratic	Virtual memory is swapping pages to and from disk storage.	Only load the no. of pages that fit into the workstation's main memory.
Mode Shape(s) not visible	Wrong Load Type setting	Change Load Type to Mode Shapes and reload.
	Displacement attributes are incorrect.	Change Displace by and Factor attributes for the Part to animate.
2D Clip plane(s) not moving	Wrong Load Type setting	Change Load Type to Mode Shapes and reload.
	Plane was not moved interactively between Start and Stop.	
Isosurface(s) not moving	Wrong Load Type setting	Change Load Type to Mode Shapes and reload.
	Isosurface was not moved interactively between Start and Stop.	
Transient data ignored	Wrong Load type	
	Solution time step specifications are incorrect.	Change Load Type to Transient and set Solution time values according to available time steps.
Pages lost	Show From or Show To pages are not at ends of flipbook.	
	Old pages are being regenerated.	Toggle-off Regen. All Pages
	Delete All Pages is clicked.	Recover using the session command file.
Transformations do not work	Flipbook pages are loaded as graphic images.	Reload flipbook pages as Graphic Objects

## 7.3 Keyframe Animation

Since its initial release in 1987, EnSight has been used extensively for animation, due to its easy-to-use keyframe animator and ability to handle transient data. This mechanism allows you to create your own movie sequence to present your results more easily. There seems to be two mind sets when it comes to animation. The first group of people believe animation to be totally trivial—something that can be completely finished in an hour or two by anyone. The other group of people seem to believe that animation is something that takes many days, if not weeks to finish and requires an “animation expert” to get done. Well, neither of these ideas are correct. While animation is not trivial, it is also not overly complicated. Most animation produced by EnSight is setup during a day, and recorded the same day or during the night to be complete by the next morning. Engineers create and record their own animations. The majority of the time involved takes place in the recording of the frames to the recording device. EnSight is intended to be used by end users—this includes the animation module. We do acknowledge, however, that there is a difference between animation, and animation done well. The latter comes with time and experience.

EnSight uses a modified keyframe technique. This technique enables the user to define what the scene should look like at certain times called Keyframe. Each keyframe can be different from a previous keyframe by using any combination of rotate, translate, scale, zoom, look-at, or look-from operations. A given keyframe can also be the same as the previous frame (the purpose of which will be explained shortly). The keyframe technique only works on transformations, and is not used for other items related to what the scene looks like (i.e., when to turn on Parts, do isosurfaces, shading changes, etc.). EnSight actually keeps track of the transformation commands performed between keyframes and linearly interpolates these commands when creating frames between the keyframes. These in-between frames are referred to as subframes.

Each keyframe includes the following information: (1) a set of transformation matrix values, specifying each local frame, the global frame and the Look-At and Look-From Points; (2) the value of all isosurfaces and position of all clip Parts using the plane tool; (3) the specific keyframe attributes; and (4) the transformation commands and isosurface values to get the scene and clip Parts to the next keyframe.

When running keyframe animation, EnSight performs the following actions for each keyframe: (1) any command language commands associated with the keyframe are executed, (2) the specified number of subframes are displayed in sequence, interpolating the transformation commands to get to the next keyframe.

To begin the process of creating an animation sequence, first define the scene you desire for the first keyframe. Then, turn on keyframe animation and create this scene as your first keyframe. You can then proceed to modify the orientation of the model and create your other keyframes.

If you make mistakes during the keyframe definition, click Delete Keyframe... and enter the number of the last keyframe you were satisfied with. Then, proceed to define the subsequent keyframes again. As soon as you have at least two keyframes defined, you may play back the animation to see what it looks like. To do this, select the Run Animation button in the Quick Interaction Area. The



animation process generally proceeds with some keyframe definitions, running what you have so far after some of those definitions, once in a while a delete back to operation, more keyframe definitions, etc., until you are satisfied with the entire animation sequence. You then set up the record information and set the process in motion to produce the images.

Note, that when playing back the animation, you do not have to always play the entire sequence. Run From, and To frame capability is provided. You also can abort an animation run by entering the “a” key in the graphics window.

In order to get the length of animation you want on video, you will need to adjust the number of sub-frames between keyframes in the Speed/Actions tab of the Run Attributes dialog. The total number of frames displayed during animation is the sum of the keyframes plus the sum of the subframes. The NTSC broadcasting standard calls for 30 frames displayed per second. On most workstations, it is unlikely that EnSight will be able to display this rapidly during playback on the workstation. So it can be difficult to get a feel for how fast the animation will be once recorded. The speed of the playback on the workstation is related both to its graphics capability and the complexity of the scene, so reducing the complexity will speed things up. Accordingly, you might consider options like making all but a representative Part invisible, use the feature angle option to reduce the visual complexity of the Parts, and/or use the dynamic/static box drawing modes.

Anything that is currently on will be on during the animation. That is, if contours, vector arrows, Particle traces, shaded surfaces, flipbook animation, animated traces, etc. are on, they will be on during animation. If any Parts have an animation delta set or are dependent on a Part that has the delta set then they will be regenerated and change through the animation. This enables you to do any of the flipbook animation techniques within keyframe animation for recording purposes, including the use of transient data (See Flipbook Animation). The advantage for doing flipbook techniques within keyframe animation is that they can be recorded and the amount of memory used is smaller because the whole flipbook is not loaded into memory. This enables the recording of long sequences of changing information that would not be able to be shown fully with flipbook animation because of memory limits of the workstation. Short sequences that you have already loaded into the flipbook can also be used by making sure that the Flipbook Run toggle is on before running keyframe animation.

If dealing with transient data, you should set up the keyframes for display of the model first, play it back, edit, etc. Then, after you are satisfied with the model presentation, you can start dealing with displaying the transient data on the model. You should be careful in doing movement of the model while transient data is being displayed. It can be confusing to have the transient data changing at the same time that the model in the scene is moving. When dealing with transient data, we normally introduce the problem first with some keyframes, then run the transient data without any transformations by defining two successive identical keyframes. Between these two identical keyframes, we animate the transient data using one of the several methods available.

We have attempted to create the animation module to be able to run in a set-up-walk-away mode to create video. In order to do this, you can issue command language lines at each keyframe (except the last one). For example, if you had a case where you wanted to first show off some of the model, and then turn on fringes to show results, you could issue a “view: fringes on” command at the

keyframe. It is also possible to play a command language file using this option. Care should be taken to *not* issue an `anim_keyframe: run` command as Part of this command language (which would cause an infinite loop).

When saving images to disk files, be aware that image files can take a great deal of disk space. The file system that you are writing images to should be monitored during the animation run to make sure it doesn't run out of space.

Clicking once on the Keyframe Animation Icon opens the Keyframe Animation Editor in the Quick Interaction Area.



Figure 7-10  
Keyframe Animation Icon



Figure 7-11  
Quick Interaction Area - Keyframe Animation Editor

<i>Keyframing Toggle</i>	Toggles-on/off Keyframe animation feature. WARNING: If you toggle-off Keyframing, all the keyframes previously created will be lost (see Save... below).
<i>Create Keyframe</i>	Click this button to create a keyframe. If Keyframing toggle is not turned on then creating the first keyframe will turn it on automatically. Keyframes are automatically numbered in sequence of their creation. As each keyframe is created, a message appears in the Status History Area.
<i>Quick Animations...</i>	Opens the Quick Animations dialog which allows you to add keyframes of predefined movement to your animation. Currently implemented are "fly around", "rotate objects", and "exploded view"
<i>Delete Keyframe...</i>	Opens the Delete Keyframes pop-up dialog which allows you to specify the number of the last keyframe you wish to retain and then delete all keyframes back to that frame. The keyframe whose number you specify is not deleted. To delete all keyframes enter 0 at the prompt.
<i>Run Animation</i>	Click to run the keyframe animation. If you click Run more than once, the animation will play for the corresponding number of times. To abort the run, press the "a" key in the Graphics Window.
<i>Run Attributes...</i>	Gives the user access to the various controls of the animation, as explained in more detail below.

Speed/Actions

Opens the Speed(Subframes)/Actions(Commands) portion of the Keyframe Run attributes dialog.

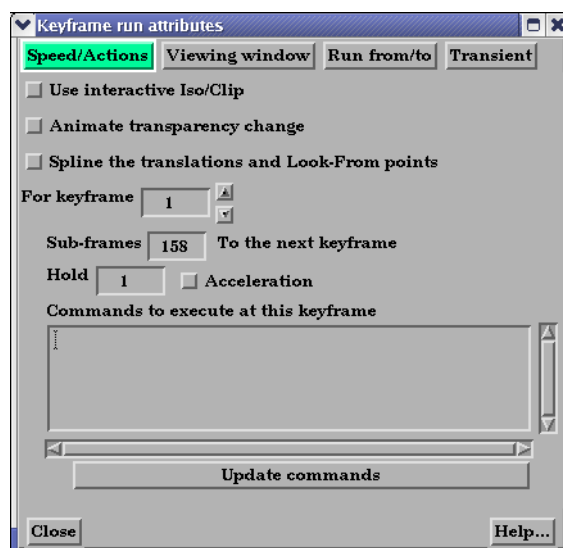

Figure 7-12  
Speed(Subframes)/Actions(Commands) portion of the Keyframe Run Attributes dialog

Use Interactive Iso/Clip	By turning this toggle on, any clip or isosurface moved interactively during the keyframe will animate.
Animate Transparency Change	By turning this toggle on, transparency changes to parts during the definition of the keyframes will be part of the animation.
Spline the Translations and Look From Points	By turning this toggle on, translations and look-at/from transforms will be interpolated on a cubic spline.
For Keyframe	This field and the stepper buttons are used to select which keyframe to edit.
Sub-Frames	The Sub-Frames field specifies the number of subframes between that keyframe specified and the next one. More subframes make the transformations to the next keyframe smoother and slower.
Hold	This field specifies the number of frames to hold at the keyframe.
Acceleration	By turning on this toggle, acceleration will be used at the keyframe. If on for a previous keyframe it will decelerate.
Commands to Execute at Keyframe	This command text area is used to specify up to 20 commands to execute before displaying the keyframe referenced in the For Keyframe field (this can be used for all keyframes except the last one). You may use any command except commands corresponding to nonpermitted actions, such as loading another dataset. Also, there is no point in using <code>view_transf</code> commands that transform frames, change the Look At and Look From points, or move the Plane Tool since the next thing EnSight does is update the Graphics Window to match the transformation matrix information stored as Part of the keyframe. You may use <code>anim_keyframe</code> commands, for example, to toggle-on using transient data, but you should not use the <code>anim_keyframe: run</code> command since then the animation will enter an infinite loop. Commands frequently used here would be <code>view:</code> and <code>annotation:</code> commands. You may also play a command file, so there is really no limit as to how many commands you can execute. The <code>shell:</code> command is a special command to issue a UNIX command.
Update Commands	This button will accept the commands entered above.

Viewing Window

Opens the Viewing Window portion of the Keyframe Run Attributes dialog.

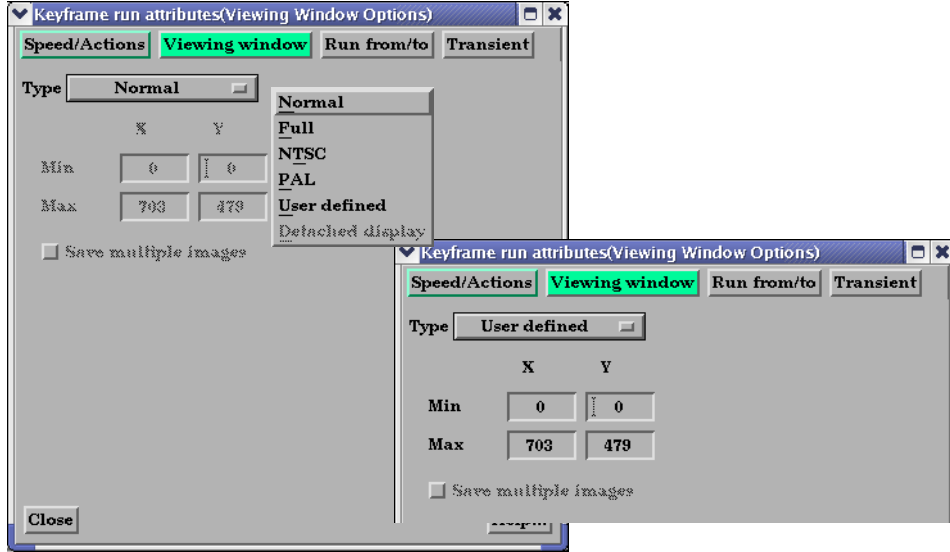

Figure 7-13  
Viewing Window portion of Keyframe Run Attributes dialog

Type

Selection of image type, including standard video formats. Options are:

- Normal* type is appropriate for display in the Graphics Window.
- Full* type is appropriate for a full-screen graphics window.
- NTSC* type is NTSC window size.
- PAL* type is PAL window size.
- User Defined* type enables you to specify the screen dimensions (see below).
- Detached Display* enables the specification of the detached display as the destination of the animation rendering.

Min X Y  
Max X Y

If Type: *User Defined*, these fields allow you to specify the pixel dimensions for user-defined type of screen. Allowed values for X are 0 to 1279 and for Y from 0 to 1023. Bottom left corner is 0,0. EnSight assumes a horizontal-to-vertical aspect ratio of 5-to-4. Other aspect ratios will distort the images.

Save Multiple Images

If Type: *Detached Display*, will save an image per display

Run From/To

Opens the Run From/To portion of the Keyframe Run Attributes dialog.

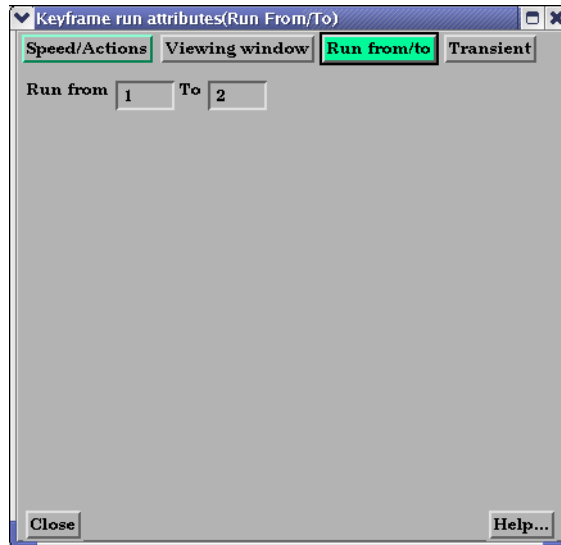

Figure 7-14  
Run From/To portion of Keyframe Run Attributes dialog.

**Run From / Run To** These fields specify the numbers of the keyframe to start from and the keyframe to run to when Run button is pressed. Must be integer numbers of already created keyframes. Default is Run From 1 and Run To number of keyframes you have created.

**Transient** Opens the Transient data synchronization portion of the Keyframe Run Attributes dialog.

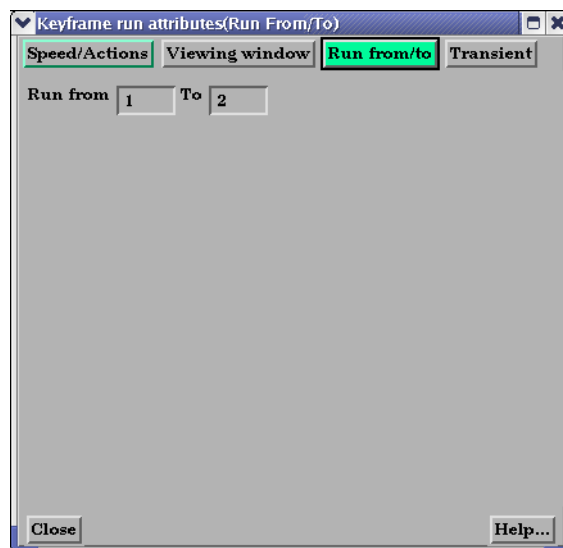

Figure 7-15  
Transient Data Synchronization portion of Keyframe Run Attributes dialog.

**Use Transient Data Toggle** Toggles-on/off transient data as defined in the timelines (see below).

**Transient Timeline** Transient data is always used according to the definitions of the transient timelines. In a timeline you can specify the start and end time, how to increment time, etc.

By default a single timeline exists which spans the total number of keyframes. Only one timeline can exist for each keyframe.

The timeline shown is the one being edited. The up/down arrows will advance/decrement to the next/previous timeline if it exists.

**New** Will create a new timeline. If the previous timeline currently spans all available keyframes a pop-up dialog will result and no new timeline will be created.

**Delete** Will delete the timeline indicated.

**Start At Keyframe** Transient data will start at the keyframe indicated.

**End At Keyframe** Transient data will end at the keyframe indicated.

**Start Time** Controls the time step to be shown at the Start Keyframe. The choices are:

*Use Begin:* Use the Begin time as defined in the Solution Time dialog

*Use End:* Use the End time as defined in the Solution Time dialog

*Use Current:* Use the current time value

*Specify:* Set the time value using the input field

**End Time** Controls the time step to be shown as the End Keyframe. The choices are the same as Start Time.

**Specify Time Increment** If off, EnSight will interpolate time such that the Start/End Time values match up with the Start/End keyframes specified. If on, you can specify the increment in time which occurs for each frame during the timeline.

## 7.3 Keyframe Animation

When Arrive At Start/End Time

If you have specified a Time increment this option controls what will happen if you arrive at the Start/End time. The choices are:

*Loop*          Jump to the begin/end time  
*Swing*         Reverse direction

Quick Animations...

Opens the Quick Animations dialog.

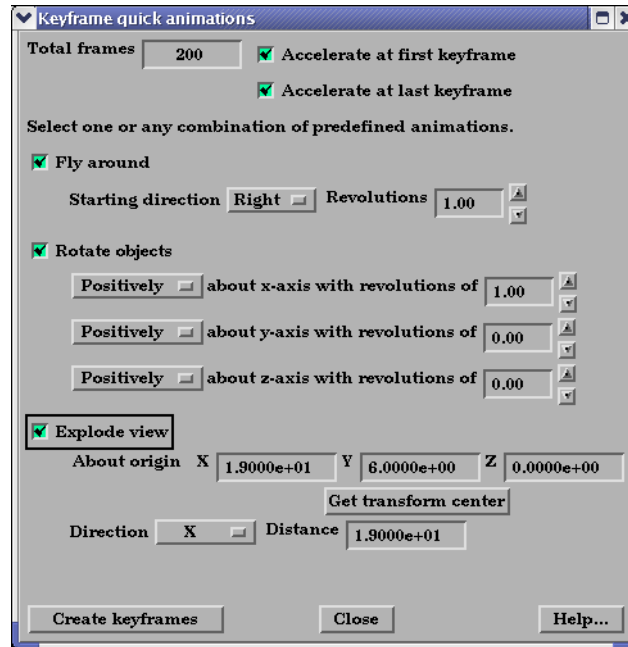

Figure 7-16  
Keyframe Quick Animations dialog

This dialog allows you to add keyframes of predefined movement to your animation. Currently implemented are "fly around", "rotate objects", and "exploded view". One or a combination of these can be used.

Total Frames	When the Create Keyframes button is pressed one or more keyframes will be created. The total frames (keyframes plus subframes) will be the number specified here.
Accelerate at first keyframe	If on, transformations will accelerate out of the first keyframe created when Create Keyframes is pressed.
Accelerate at last keyframe	If on, transformations will de-accelerate at the last keyframe created when Create Keyframes is pressed.
Fly Around	If on the look-from point will be revolved around the scene by the number of revolutions specified. The viewer can either rotate to the Right or the Left. The keyframes will be added when the Create Keyframes button is pressed.
Rotate Objects	If on the objects will be rotated about the x, y, and/or z axis by the number of revolutions specified. The keyframes will be added when the Create Keyframes button is pressed.
Explode View	If on the objects will be assigned local axis systems and animated Distance units in the Direction given about the origin specified. The global axis direction is used.
About Origin XYZ	The origin about which the explode will occur.
Get Transform Center	Sets the About Origin to be at the current transform center.
Direction	The direction of the explode transform. The choices are: X            Translate in the x direction

Y	Translate in the y direction
Z	Translate in the z direction
XYZ	Translate in all three directions
Radial	Translate in the direction defined by a vector from the given origin through the part centroid.

For example, if the origin given is 0,0,0 and the explode direction is X, a part with a centroid at X=1 will translate in the positive X direction while a part with a centroid at X=-1 will translate in the negative X direction

Distance	The total translation to be used.
Create Keyframe	Creates the keyframe(s) given the selections in the dialog. If keyframe animation is currently not on it will turn it on and create an initial keyframe, then add the predefined transform indicated.
Record...	Opens the Keyframe Animation Recorder dialog.

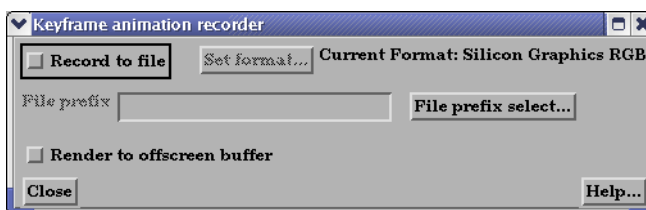
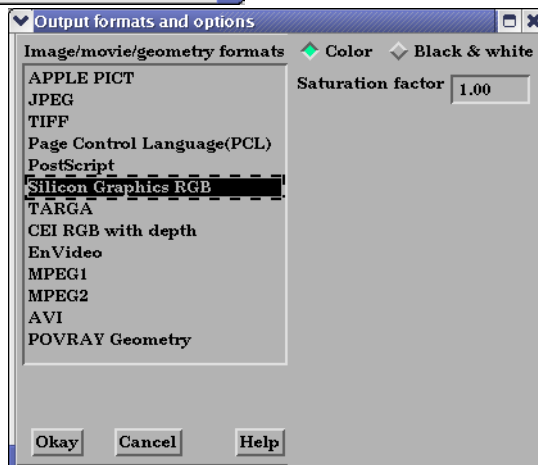

Figure 7-17  
Keyframe Animation Recorder dialog



Record To File	When on, will record the keyframe animation images to the specified filename(s).
Set Format...	Brings up the Image/Movie Format and Options dialog. The flipbook will be recorded using the selected format. (see <a href="#">Section 2.11, Saving and Printing Graphic Images and How to Print/Save an Image</a> )
File Prefix	Specification of filename prefix to use when saving frames to a disk file. Each frame is saved in a different file according to the File Numbering. The prefix can also have a directory path before it, such as /usr/tmp/prefix.
Save...	Opens the File Selection dialog to allow you to save the specifications of the current keyframe into a file. This saves only the keyframe specifications, not the animation images or Part information. If you perform a Full Backup, the keyframe specifications are saved as Part of the Backup.
Restore...	Opens the File Selection dialog to allow you to restore keyframe specifications from a file. This restores only the keyframe specifications; you must also load Part data and set the Part attributes.  (see <a href="#">How To Create a Keyframe Animation</a> )

## Troubleshooting Keyframe Animation

Problem	Probable Causes	Solutions
Graphics Window flashes at start of animation run.	New graphics window is opened to display the animation.	Hardware specific. Does not affect frames sent to recorder.
Colors seem to bleed when I play the recorded tape back.	The color display from tape has a tendency to bleed colors that are pure, such as full intensity red, green, or blue.	Don't use them. If you want a red object don't use full intensity, and mix in some other components. For example you may want to try RGB =.9 .1 .1.
Lines "crawl" across the screen when I play the recorded tape back.	Lines are only 1 pixel wide which would cause crawling on video tape.	Use a line width greater than 1.
During playback the action of the video starts as soon as the picture comes up and it's hard to recognize what is happening that quickly and then it goes away.	When creating a video it is best to have the model come up with a hold of 3 seconds or more before starting the animation. The animation should run for a reasonable length of time and then it should hold for 3 or more seconds again at the end. On complex models the hold may need to be as much as 10.	Holding a video at the beginning and the end and showing enough frames in-between will allow your audiences eyes to adjust and increase comprehension of the video. Adding annotation strings and pointers to point out areas of interest also helps. Also, showing the whole model with a hold and then zooming way in on the area of interest will help comprehension.
Video is too fast when played back from a recorded tape, but it looked fine on the monitor.	Video formats play back at rates that are normally faster than the workstation hardware can. For example, NTSC plays back at 30 frames per second which can be impossible for the workstation to match on a fairly complex model.	Increase the number of frames recorded by adding more subframes or by possibly having your video recording device record more than one frame when EnSight tells it to record.
Transformation of my object on the recorded tape is not smooth.	Not enough subframes.	Adding more subframes will cause more finely interpolated scene between keyframes. For instance the model should probably not rotate more than 3 degrees between frames being recorded.
Model is being clipped away as the animation proceeds.	Running into the Z-Clip plane or the regular plane tool with Clipping on.	Make sure the Z-Clip planes and the plane tool are far enough away from the model for the whole animation sequence. NOTE: The distance between the Z-Clip planes could affect the clarity of the image. The Z-Clip should be kept as close to the model and as close to each other as possible for better results.
A slight pause occurs when animation is played	EnSight has a 1 second pause to ensure the animation window is ready for animation.	



## 7.4 Variable Calculator

While the Variable Calculator is located on the Feature Icon Bar, it's use is discussed in Chapter 4, [Section 4.3, Variable Creation](#)



Figure 7-18  
Variable Calculator Icon

## 7.5 Query/Plot

EnSight provides several ways to examine information about variable values. You can, of course, visualize variable values with fringes, contours, vector arrows, profiles, isosurfaces, etc. This section describes how to query variables *quantitatively*:

*Over Distance* EnSight can query variables at points over distance for the following information:

- variable values inside Parts at evenly spaced points along a straight line
- variable values inside Parts at the nodes of a different 1D Part

*Over Time* EnSight can query variables over time for the following information:

- minimum and maximum variable values for Parts
- variable values at any number of sample times at any point inside of a Part or at any labeled node or element.

Over-time queries can report actual variable values, or Fast Fourier Transform (FFT) spectral values at the positive FFT frequencies.

*Variable vs. Variable* EnSight can produce a scatter plot of one variable vs. another.

*Operations on* EnSight can scale query values and/or combine one set of query values with another set to produce a new set of values.

*Importing* EnSight can import query values from external files.

**Query Candidates** Only Parts with data residing on the Server host system may be queried. Thus, Parts that reside exclusively on the Client host system (i.e. contours, particle traces, profiles, vector arrows) may NOT be queried.

(see Section 3.1, Part Overview)

Clicking once on the Query/Plot Icon opens the Query/Plot Editor in the Quick Interaction Area which is used to query about the selected Variable on the selected Part and, if you wish, assign a query entity to a plotter.



Figure 7-19  
Query/Plot Icon

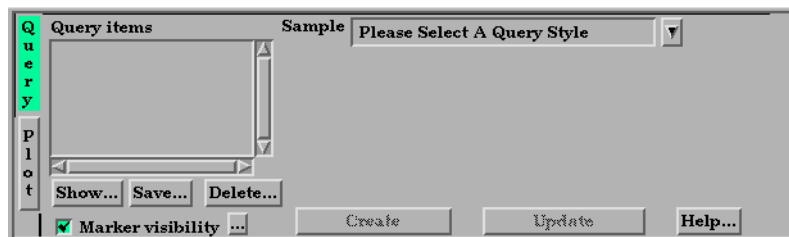

Figure 7-20  
Quick Interaction Area - Query/Plot Editor

**Query Items** This is the list of query items that currently exist in EnSight. After creating a query item, it will show up in this list and can be modified by selecting it in the list and changing the displayed values. (Note, it is best to deselect any query items in the list when creating a

new one, otherwise you may accidentally modify values for the item with the left mouse button.)

### Sample

This menu contains the types of queries that can be created. Selecting one of these changes the interface to display controls related to the type.

Figure 7-21  
Query Sample Types

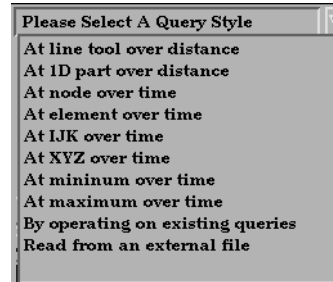

*Please Select A Query Style*

*At Line Tool Over Distance*

*At 1D Part Over Distance*

*At Node Over Time*

*At Element Over Time*

*At IJK Over Time*

*At XYZ Over Time*

*At Minimum Over Time*

*At Maximum Over Time*

*By Operating On Existing Queries*

*Read From An External File*

is displayed until a Sample selection is made.

queries at uniform points along the line tool.

queries at the nodes of a 1D part.

queries at a node over a range of times.

queries at an element over a range of times.

queries at an IJK location over a range of times.

queries at the x, y, z location over a range of times.

queries the minimum of a variable over a range of times.

queries the maximum of a variable over a range of times.

forms new query by scaling and/or combining existing ones.

imports previously saved or externally generated queries. (This can be EnSight XY data format or MSC Dytran .ths files.)

## General to Each Type of Query

### Marker Visibility

Toggles the visibility of the marker showing the location for the query. For distance queries, a sphere marker will be shown indicating the beginning location for the query.

...

Opens the Query Display Attributes dialog for the specification of the display attributes of the query marker.

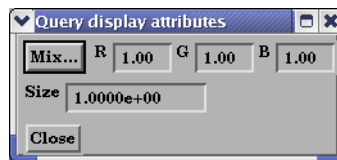

Figure 7-22  
Query Marker Display Attributes dialog

Mix...

Opens the Color Selector to specify the color of the marker.

RGB

The red, green, and blue color for the marker.

Size

The size of the sphere marker. The value is a scale factor. Values larger than 1.0 will scale the marker up, while values less than 1.0 (but greater than 0.0) will scale the marker down.

Update

This button causes the query to be recomputed using any modified attributes or variables.

**Save...** Opens the Save Entity Query To dialog for the specification of the format, and file name in which you wish to save the query entity.

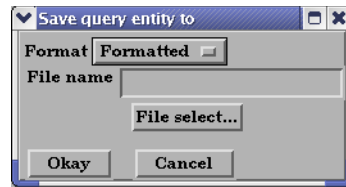

Figure 7-23  
Save Query Entity To dialog

**Format** Opens a pop-up menu to allow specification of the format. Choices are:

- Formatted* Outputs the query information to the specified file in the same format as the Show Text button.
- XY Data* Outputs the query information in a generic format which could be used to export the information to a different plotting system.

**File Name** This field is used to specify the file name in which you wish to save the query entity.

**File Select** Opens up the File Selection dialog for specifying the File Name as an alternative to entering it manually in the File Name field.

**Show...** This button will display the results of the selected query in the EnSight Message Window.

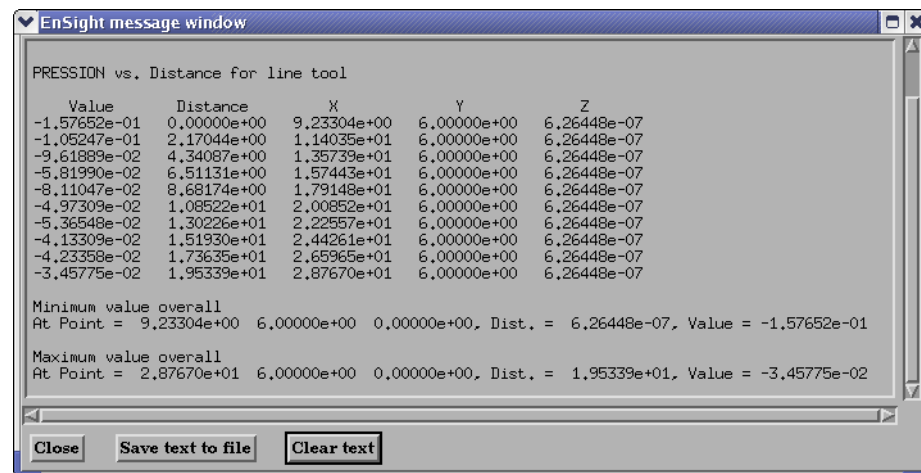

Figure 7-24  
EnSight Message Window displaying query information

**Save Text To File** Opens the File Selection dialog for specification of filename to save to.

**Delete...** This button will delete the selected query items. You must confirm the deletion before it is actually done.

**Create** This button will create the query according to options and variables specified.

## Plot

Changes the Quick Interaction Area into the plotting section.

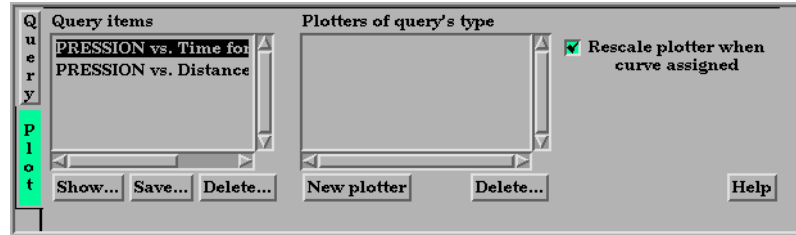

Figure 7-25  
Plot Query Entity To dialog

Query Items	Shows a list of current query items. As you select these, the plotters of the same type (if any) will be displayed in the Plotters Of Query's Type list. And if the query has been assigned to one of these plotters, it will be highlighted.
Plotters Of Query's Type	Shows a list of currently defined Plotters which are of the same type as the selected query. The selected query can be plotted on these or on a new plotter.
Rescale plotter	If a query is assigned to an existing plotter by selecting one in the Plotter Of Query's Type list, toggling this option will rescale the axis of the Plotter to include all queries that are assigned to it.
New Plotter	Will create a new plotter, add the new plotter to the list, and display the plotter with its query curve in the graphics window.
Delete...	Will delete the selected plotters. You must confirm the deletion before it is actually done.

## Query

### At Line Tool Over Distance

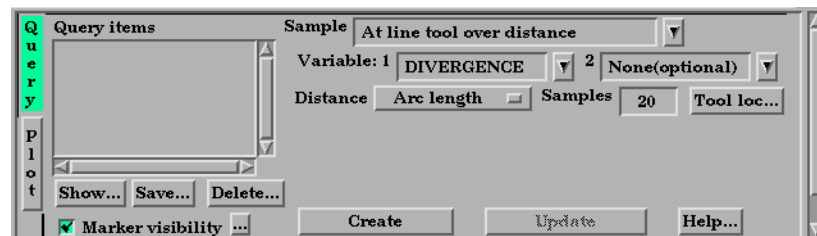

Figure 7-26  
Quick Interaction Area - Query/Plot Editor - **At Line Tool Over Distance**

<i>Variable: 1</i>	A list of variables than can be chosen for the query. If plotted, this variable will be plotted along the Y-Axis.
<i>Variable: 2</i>	If you leave this as “None”, DISTANCE will be the default X- Axis variable. If you choose a variable from the list, a “scatter plot” query will result, and the X-Axis will be the variable you have chosen.
<i>Distance</i>	A menu of choices that control the distance parameter. <ul style="list-style-type: none"> <li><i>Arc Length</i>      The distance along the part from the first node to each subsequent node (i.e. the sum of the 1D element lengths).</li> <li><i>X Arc Length</i>    The X coordinate value of each node accumulated from the start.</li> <li><i>Y Arc Length</i>    The Y coordinate value of each node accumulated from the start</li> <li><i>Z Arc Length</i>    The Z coordinate value of each node accumulated from the start.</li> <li><i>From Origin</i>     The distance from the origin.</li> <li><i>X from Origin</i>   The X distance from the origin.</li> <li><i>Y from Origin</i>   The Y distance from the origin.</li> <li><i>Z from Origin</i>   The Z distance from the origin.</li> </ul>

- Samples** For queries over Distance using the Line Tool, this field specifies the number of equally spaced points to query along the line.
- Tool Loc...** Brings up the Transformation Editor (Line Tool) dialog for feedback and manipulation of the location of the line tool.

**At 1D Part Over Distance**

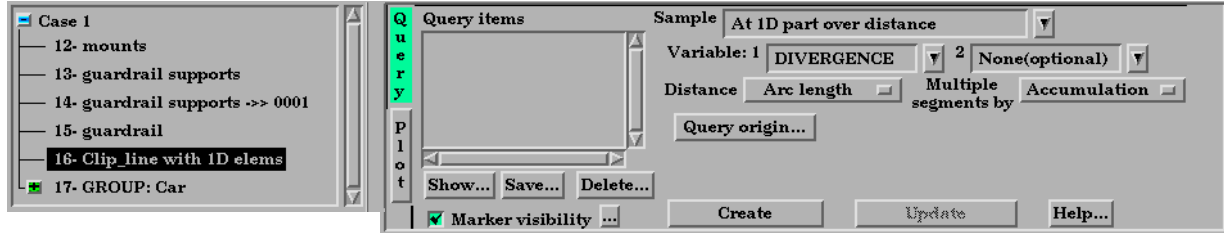

Figure 7-27  
Quick Interaction Area - Query/Plot Editor - **At 1D Part Over Distance**

*Note that the 1D part to use for the query must be selected from the Part's list.*

**Variable: 1** A list of variables than can be chosen for the query. If plotted, this variable will be plotted along the Y-Axis.

**Variable: 2** If you leave this as “None”, DISTANCE will be the default X- Axis variable. If you choose a variable form the list, a “scatter plot” query will result, and the X-Axis will be the variable you have chosen.

**Distance** A menu of choices that control the distance parameter.

- Arc Length* The distance along the part from the first node to each subsequent node (i.e. the sum of the 1D element lengths).
- X Arc Length* The X coordinate value of each node accumulated from the start.
- Y Arc Length* The Y coordinate value of each node accumulated from the start
- Z Arc Length* The Z coordinate value of each node accumulated from the start.
- From Origin* The distance from the origin.
- X from Origin* The X distance from the origin.
- Y from Origin* The Y distance from the origin.
- Z from Origin* The Z distance from the origin.

**Multiple Segments By** When the selected 1D part contains more than one contiguous segment, these are handled by:

- Accumulation* Each segment’s query is appended to the previous. Thus a plot of this query will be one extended curve, but the extents of individual segment may not be obvious.
- Reset Each* Each segment’s query is treated like it is independent. Thus a plot of this query will appear as several curves.

**Query Origin...** Brings up the Query Origin dialog for feedback and manipulation of the location of the query origin.

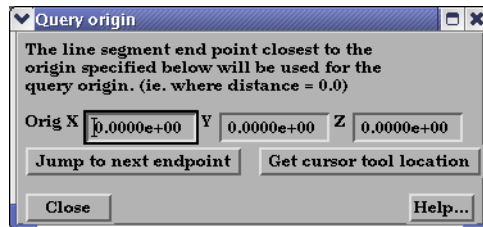

Figure 7-28  
Query Origin dialog

Orig XYZ	Coordinates of the location to use for query origin determination. The endpoint closest to the origin specified will be used as the “origin” of the query, i.e., where distance is zero. If the 1D part is a closed loop (i.e. there are no end points), the closest point on the loop is used as the “origin”.
Jump To Next Endpoint	When multiple segments are present, clicking this button jumps to the beginning of the next segment, placing that location into the Orig XYZ fields.
Get Cursor Tool Location	Places the current cursor tool location into the Orig XYZ fields so that point can be used as the query origin.

### At Node Over Time

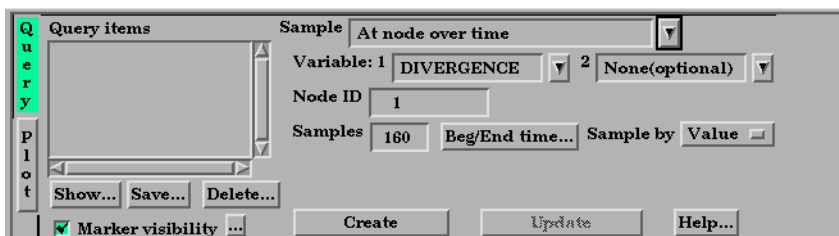

Figure 7-29

Quick Interaction Area - Query/Plot Editor - **At Node Over Time**

<i>Variable: 1</i>	A list of variables that can be chosen for the query. If plotted, this variable will be plotted along the Y-Axis.
<i>Variable: 2</i>	If you leave this as “None”, TIME will be the default X- Axis variable. If you choose a variable from the list, a “scatter plot” query will result, and the X-Axis will be the variable you have chosen.
<i>Samples</i>	Specifies how many evenly timed moments over the specified range of time steps at which to query (if left blank, you get a sample point at each time step). If you specify more or fewer sample points than the number of time steps, EnSight linearly interpolates between the adjoining time steps. If query is an FFT sampling, the number of frequencies output will be less than or equal to the number of sample points.
<i>Node ID</i>	Specifies a node ID.
<i>Beg/End Time...</i>	Opens up the Solution Time Editor in the Quick Interaction Area. Here you can specify the start and end times for queries Over Time. (see <a href="#">Section 7.2, Flipbook Animation</a> )
<i>Sample By</i>	Opens a pop-up menu for specification of how to report values for Over Time queries. Options are: <i>Value</i> reports values versus time. <i>FFT</i> reports FFT spectral values versus FFT positive frequencies.

### At Element Over Time

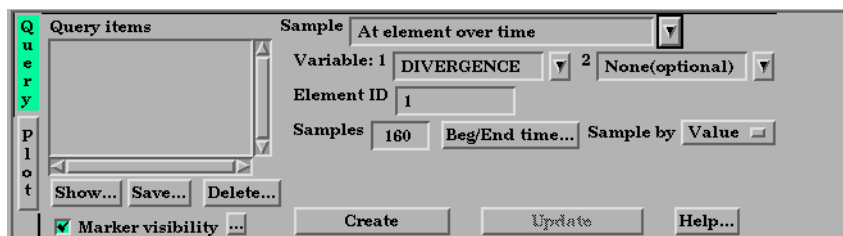

Figure 7-30

Quick Interaction Area - Query/Plot Editor - **At Element Over Time**

<i>Variable: 1</i>	A list of variables that can be chosen for the query. If plotted, this variable will be plotted along the Y-Axis. (Note: only per_element variables can be used for this query type.)
--------------------	---

<i>Variable: 2</i>	If you leave this as “None”, TIME will be the default X- Axis variable. If you choose a variable form the list, a “scatter plot” query will result, and the X-Axis will be the variable you have chosen.
<i>Samples</i>	Specifies how many evenly timed moments over the specified range of time steps at which to query (if left blank, you get a sample point at each time step). If you specify more or fewer sample points than the number of time steps, EnSight linearly interpolates between the adjoining time steps. If query is an FFT sampling, the number of frequencies output will be less than or equal to the number of sample points.
<i>Element ID</i>	Specifies an element ID.
<i>Beg/End Time...</i>	Opens up the Solution Time Editor in the Quick Interaction Area. Here you can specify the start and end times for queries Over Time. (see Section 7.2, Flipbook Animation)
<i>Sample By</i>	Opens a pop-up menu for specification of how to report values for Over Time queries. Options are: <ul style="list-style-type: none"> <li><i>Value</i> reports values versus time.</li> <li><i>FFT</i> reports FFT spectral values versus FFT positive frequencies.</li> </ul>

### At IJK Over Time

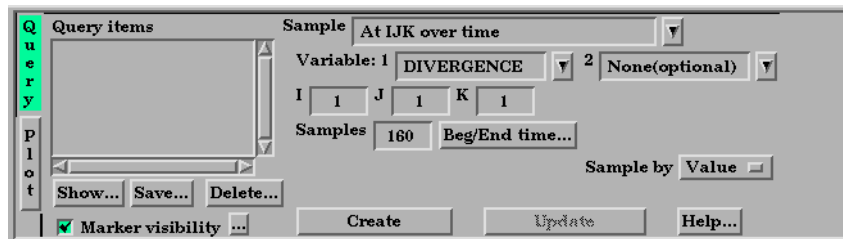

Figure 7-31  
Quick Interaction Area - Query/Plot Editor - At IJK Over Time

<i>Variable: 1</i>	A list of variables than can be chosen for the query. If plotted, this variable will be plotted along the Y-Axis.
<i>Variable: 2</i>	If you leave this as “None”, TIME will be the default X- Axis variable. If you choose a variable form the list, a “scatter plot” query will result, and the X-Axis will be the variable you have chosen.
<i>Samples</i>	Specifies how many evenly timed moments over the specified range of time steps at which to query (if left blank, you get a sample point at each time step). If you specify more or fewer sample points than the number of time steps, EnSight linearly interpolates between the adjoining time steps. If query is an FFT sampling, the number of frequencies output will be less than or equal to the number of sample points.
<i>IJK</i>	Specifies the IJK planes of the desired location.
<i>Beg/End Time...</i>	Opens up the Solution Time Editor in the Quick Interaction Area. Here you can specify the start and end times for queries Over Time. (see Section 7.2, Flipbook Animation)
<i>Sample By</i>	Opens a pop-up menu for specification of how to report values for Over Time queries. Options are: <ul style="list-style-type: none"> <li><i>Value</i> reports values versus time.</li> <li><i>FFT</i> reports FFT spectral values versus FFT positive frequencies.</li> </ul>



## At XYZ Over Time

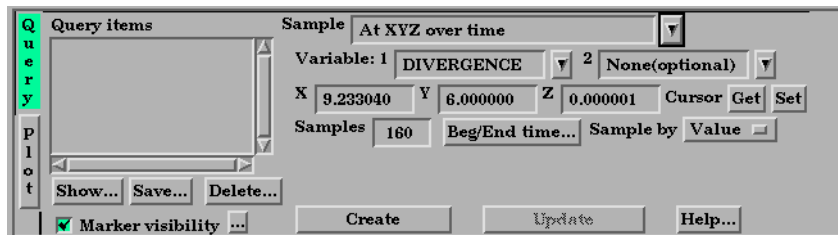

Figure 7-32  
Quick Interaction Area - Query/Plot Editor - **At Cursor Over Time**

**Variable: 1** A list of variables that can be chosen for the query. If plotted, this variable will be plotted along the Y-Axis.

**Variable: 2** If you leave this as “None”, TIME will be the default X- Axis variable. If you choose a variable from the list, a “scatter plot” query will result, and the X-Axis will be the variable you have chosen.

**Samples** Specifies how many evenly timed moments over the specified range of time steps at which to query (if left blank, you get a sample point at each time step). If you specify more or fewer sample points than the number of time steps, EnSight linearly interpolates between the adjoining time steps. If query is an FFT sampling, the number of frequencies output will be less than or equal to the number of sample points.

**Get Set** Get will put the current coordinates of the cursor tool into the x, y and z fields. Set will open up the Transformation Editor (Cursor Tool) dialog for specification of the cursor location. You can of course also set this location using interactive or picking methods.

**Beg/End Time...** Opens up the Solution Time Editor in the Quick Interaction Area. Here you can specify the start and end times for queries Over Time.  
(see [Section 7.2, Flipbook Animation](#))

**Sample By** Opens a pop-up menu for specification of how to report values for Over Time queries. Options are:

*Value* reports values versus time.

*FFT* reports FFT spectral values versus FFT positive frequencies.

## At Minimum Over Time

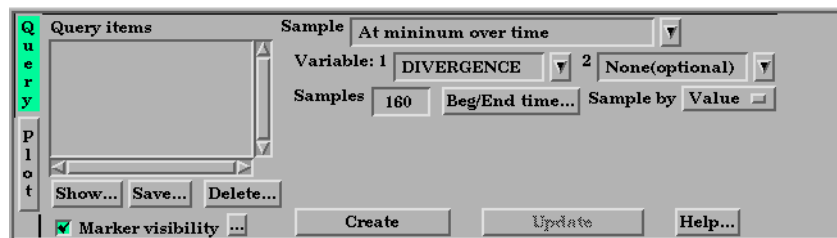

Figure 7-33  
Quick Interaction Area - Query/Plot Editor - **At Minimum Over Time**

**Variable: 1** A list of variables that can be chosen for the query. If plotted, this variable will be plotted along the Y-Axis.

**Variable: 2** If you leave this as “None”, TIME will be the default X- Axis variable. If you choose a variable from the list, a “scatter plot” query will result, and the X-Axis will be the variable you have chosen.

**Samples** Specifies how many evenly timed moments over the specified range of time steps at which to query (if left blank, you get a sample point at each time step). If you specify more or fewer sample points than the number of time steps, EnSight linearly interpolates between

the adjoining time steps. If query is an FFT sampling, the number of frequencies output will be less than or equal to the number of sample points.

**Beg/End Time...** Opens up the Solution Time Editor in the Quick Interaction Area. Here you can specify the start and end times for queries Over Time.  
(see Section 7.2, Flipbook Animation)

**Sample By** Opens a pop-up menu for specification of how to report values for Over Time queries. Options are:

- Value* reports values versus time.
- FFT* reports FFT spectral values versus FFT positive frequencies.

**At Maximum Over Time**

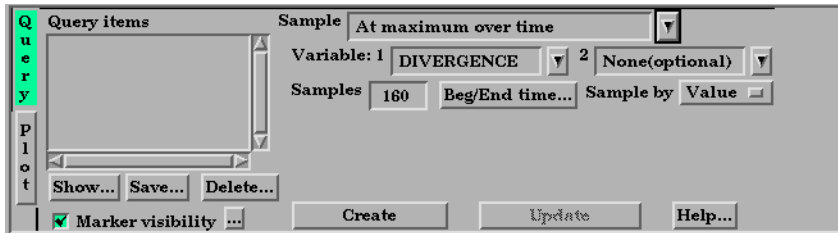

Figure 7-34 Quick Interaction Area - Query/Plot Editor - **At Maximum Over Time**

**Variable: 1** A list of variables than can be chosen for the query. If plotted, this variable will be plotted along the Y-Axis.

**Variable: 2** If you leave this as “None”, TIME will be the default X- Axis variable. If you choose a variable form the list, a “scatter plot” query will result, and the X-Axis will be the variable you have chosen.

**Samples** Specifies how many evenly timed moments over the specified range of time steps at which to query (if left blank, you get a sample point at each time step). If you specify more or fewer sample points than the number of time steps, EnSight linearly interpolates between the adjoining time steps. If query is an FFT sampling, the number of frequencies output will be less than or equal to the number of sample points.

**Beg/End Time...** Opens up the Solution Time Editor in the Quick Interaction Area. Here you can specify the start and end times for queries Over Time.  
(see Section 7.2, Flipbook Animation)

**Sample By** Opens a pop-up menu for specification of how to report values for Over Time queries. Options are:

- Value* reports values versus time.
- FFT* reports FFT spectral values versus FFT positive frequencies.

**By Operating On Existing Queries**

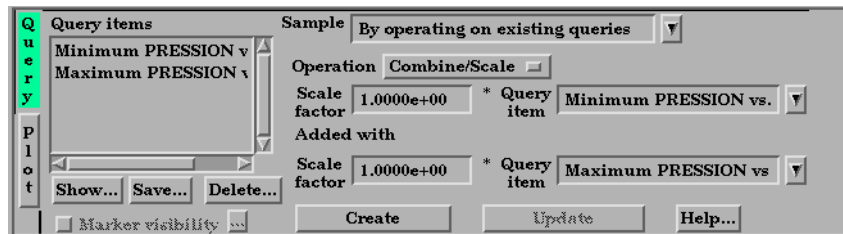

Figure 7-35 Quick Interaction Area - Query/Plot Editor - **By Operating On Existing Queries**

- Scale Factor** Scale factor for the Query Item selected. The values of the selected query will be multiplied by this factor either before it is added to the second query or before the new query is created (if only operating on a single query).
- Query Item** The existing query item(s) to operate on. A new query will be create consisting of scaled values one query, or the scaled, algebraic sum of two queries.

### Read From An External File

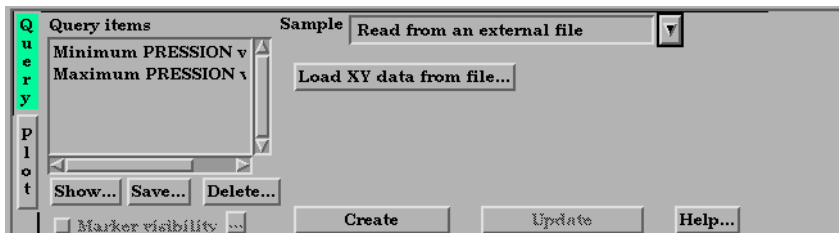

Figure 7-36

Quick Interaction Area - Query/Plot Editor - **Read From An External File**

- Load XY Data From File** Opens the File Selection dialog from which a previously saved or externally generated query can be retrieved. EnSight's XY data format or MSC Dytran .ths files can be read.

(See also [How To Query/Plot](#))

## 7.6 Interactive Probe Query

EnSight enables you to obtain scalar, vector, or coordinate information for the model at a point directly under the mouse pointer, at the location of the cursor tool, or at particular node, element, ijk, or xyz locations. The information is normally displayed in the Interactive Probe Query section of the Quick Interaction Area, but it can also be displayed in the Graphics Window. The performance of Interactive Query operations is dependent on the refresh time of the Graphics Window. Interactive query values are not echoed to EnSight command language files.

Clicking once on the Interactive Probe Query Icon opens the Interactive Probe Query Editor in the Quick Interaction Area which is used to specify parameters for querying interactively.



Figure 7-37  
Interactive Probe Query Icon

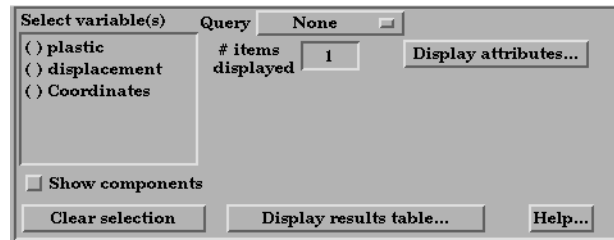

Figure 7-38  
Quick Interaction Area - Interactive Probe Query Editor

### Select Variable(s) Query

List of variables and their components (if vector and Show Components is toggles on).  
Selection of whether interactive query is on, or which method to use to indicate input.

*Surface Pick* will query the location under the mouse in the Main View. The query will be performed when the “p” keyboard key is pressed (when “Pick Use ‘p’ ” is on) or whenever the mouse moves to a new location in the Main View (when “Continuous” is on).

*Cursor* will query the location indicated by the Cursor Tool in the Main View. The query will be performed when the “p” keyboard key is pressed (when “Pick Use ‘p’ ” is on) or whenever the Cursor Tool moves to a new location in the Main View (when “Continuous” is on).

*Node* will query the node as specified in the “Node ID” field.

*IJK* will query the IJK node as specified in the “I J K” fields.

*Element* will query the element as specified in the “Element ID” field.

*XYZ* will query the x, y, z location as specified in the “x y z” fields.

*None* indicates that interactive query is off.

### Search

Selects the location for the query. (Only active for Surface Pick and Cursor queries.)

*Exact* indicates that the query will occur at the location of the mouse.

*Closest Node* indicates that the query will “snap” to the node closest to the mouse.

<i>Pick (Use 'p')</i>	When the Action is Surface Pick or Cursor, controls whether the query will occur on a keyboard 'p' key press (when on) or will occur continuously - tracking the mouse location.
<i>Node ID</i>	For Node Queries, specify the node id.
<i>Element ID</i>	For Element Queries, specify the element id.
<i># Items Displayed</i>	Sets the number of query locations that are kept in memory and displayed to the user.
<i>Clear Selection</i>	Clears all the selected variables.
<i>Display Results Table...</i>	Opens the Interactive Probe Query Results Table dialog which shows a table of all selected variables as well as the current query type, the latest xyz coordinates, the latest ijk values (if applicable), and the latest node or element id (if applicable). Note that the contents of this dialog can be saved to a file by using the Save... button.

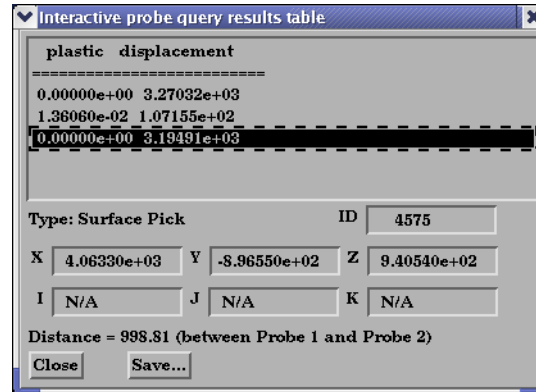

Figure 7-39  
Interactive Probe Query Results Table

*Display Attributes...* Opens the Interactive Probe Query Display dialog.

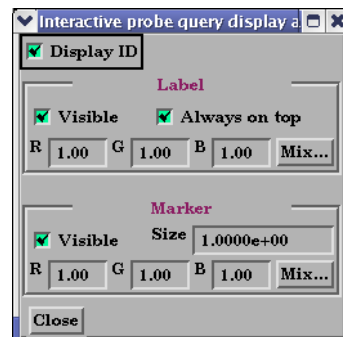

Figure 7-40  
Interactive Probe Query Display dialog

Display ID Toggle	When toggled on, if an ID is appropriate for the type of search, will display the ID in the query table and in the label on the model.
Label	
Visible Toggle	When toggled on, query information will be displayed in the Graphics Window
Always on Top	When on, query information in the Graphics Window will not be hidden from view behind other geometry.
RGB	These fields specify color values for the Labels.
Mix	Opens the Color Selector dialog (see Section 8.1, Color Selector)
Marker	
Visible	When on, query location markers will be displayed in the Graphics Window.
Size	The size of the markers.
RGB	These fields specify color values for the markers.
Mix	Opens the Color Selector dialog (see Section 8.1, Color Selector)

## 7.7 Contour Create/Update

Contours are lines that trace out constant values of a variable across the surface(s) of selected Part(s), just like contour lines on a topographical map.

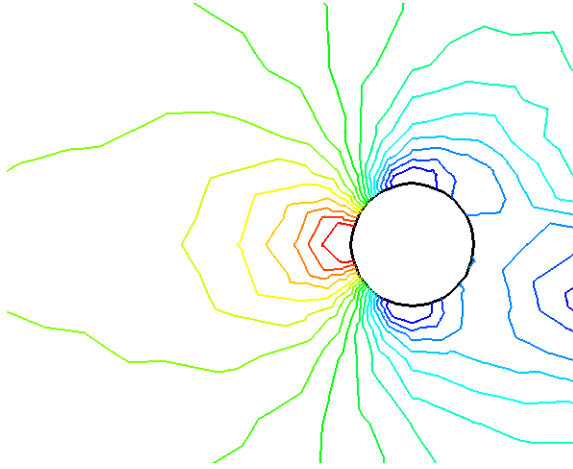

Figure 7-41  
Pressure Contours in a Flow Field around a Circular Obstruction

The variable must be a scalar or vector variable. If it is a vector, the magnitude will be used by default, but one component can be used as well. A Contour Part can consist of one contour line, or a set of lines corresponding to the value-levels of the variable palette. A Contour Part has its own attributes independent of those Parts used to create it (the parent Part(s)).

Contours are drawn across the faces of parent Part elements (one-dimensional elements are ignored). At each node along the edges of any one element face, the contour's variable has a value. If the range of these values includes the contour's value-level, the contour line crosses the face. EnSight draws the contour by dividing the face into triangles each having the face's centroid as one vertex. For each triangle the contour crosses, it will cross only two sides. EnSight interpolates to find the point on each of those two sides where the variable value equals the contour value-level, then creates a bar element to connect the two points. Note that a contour line can bend while crossing an element face.

Because Contour Parts are created on the EnSight Client, the Representation attribute of the parent Part(s) greatly affects the result. Representations that reduce Part elements to one-dimensional representations (Border applied to two-dimensional Parts and Feature Angle), or do not download the Part (Not Loaded), will eliminate those Part elements from the Contour creation process. On the other hand, Full representation of three-dimensional elements will create contour lines across hidden surfaces. Usually, you will want the Representation selection to be 3D Border, 2D Full.

Contour Parts are created on the Client, and so cannot be queried or used in creating new variables. However, Contours can be used as parent Parts for Profiles and Vector Arrows.

If you change the value-levels in the Feature Detail Editor (Variables) Summary and Palette section, the Contour automatically regenerates using the new value-levels.

Use care when simultaneously displaying contours based on different function palettes so that you do not become confused as to which contours are which. Coloring them differently and adding an on-screen legend can help.

Clicking once on the Contour Create/Update Icon opens the Contour Editor in the Quick Interaction Area which is used to both create and update (make changes to) contour Parts.



Figure 7-42  
Contour Create/Update Icon

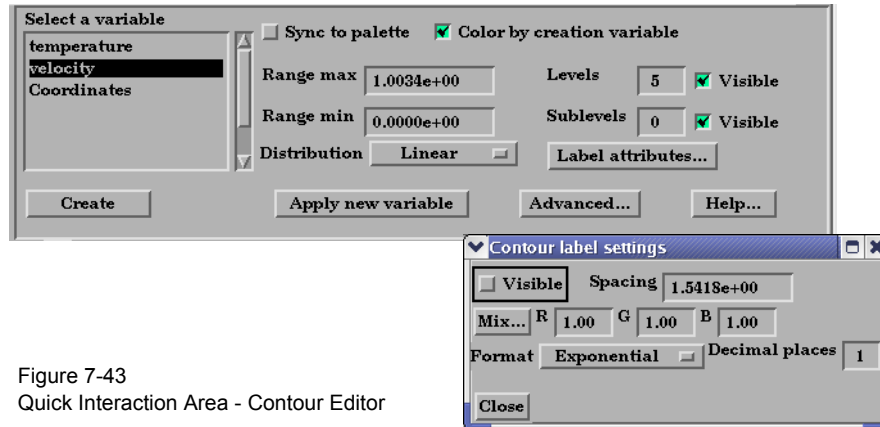

Figure 7-43  
Quick Interaction Area - Contour Editor

Sync To Palette	Toggles on/off the contour line synchronization to the legend color palette.
Color by creation	If toggled on at Contour part creation, then the Contour Part is colored by the variable.
Range Min	This field is activated when Sync to Palette Toggle is Off.
Range Max	This field is activated when Sync to Palette Toggle is Off.
Distribution	This pop-up menu is activated when Sync to Palette Toggle is Off. Opens a pop-up menu for the selection of a distribution function for the contour lines. Choices include Linear, Logarithmic, and Quadratic.
Levels	This field is activated when Sync to Palette Toggle is Off. This field determines the number of contours between the Range Min and Range Max.
Visible	Toggles whether the main level contours are visible or not.
Sublevels	This field allows you to specify the number of sub-contours you wish to be drawn at evenly spaced value-levels between the value-levels defined in the Variable Feature Detail Editor Summary and Palette section. Leaving this field 0 will produce exactly the number of contour lines for which value levels are specified in the Feature Detail Editor (Variables) Summary and Palette.
Visible	Toggles whether the sublevel contours are visible or not.
Label Attributes...	Opens the Contour Label Settings dialog.
Visible Toggle	Toggles on/off the visibility of number labels for contour lines.
Spacing	Determines the spacing between number labels.
Mix...	Opens the Color Selector dialog for the assignment of a color to number labels.
R,G,B	Allows the specification of red, green, and blue values for the assignment of a color to number labels.
Format	This pop-up menu allows selection of format of number labels. Choices include Exponential, and Floating Point.

## 7.7 Contour Create/Update

Decimal Places	This field allows the specification of the number of decimal places of the number labels.
Create	Creates a Contour Part using the selected Part(s) in the Parts List and the color palette associated with the Variable currently selected in the Main Variables List.
Apply New Variable	Will change the Contour Part to show contours based on the color palette associated with the Variable currently selected in the Variables List.
Advanced	Will open the Feature Detail Editor and select the Contours icon for more advance control of the Contour Part.
Feature Detail Editor (Contours)	Double clicking on the Contour Create/Update Icon opens the Feature Detail Editor (Contours), the Creation Attributes Section of which provides access to the same functions available in the Quick Interaction Area, as well as one more. For a detailed discussion of the remaining Feature Detail Editor turn-down sections (which are the same for all Part types):
Display offset	<p>This field specifies the normal distance away from a surface to display the contours. A positive value moves the contours away from the surface in the direction of the surface normal. A negative value moves in the negative surface normal direction.</p> <p><i>Please note that there is a hardware offset that will apply to contours, vector arrows, separation/attachment lines, and surface restricted particle traces that can be turned on or off in the View portion of Edit-&gt;Preferences. This preference (“Use graphics hardware to offset line objects...”) is on by default and generally gives good images for everything except move/draw printing. This hardware offset differs from the display offset in that it is in the direction perpendicular to the computer screen monitor (Z-buffer).</i></p> <p>Thus, for viewing, you may generally leave the display offset at zero. But for printing, a non-zero value may become necessary so the contours print cleanly.</p> <p>(see <a href="#">Section 3.3, Part Editing</a> and <a href="#">How to Create Contours</a>)</p>

### Troubleshooting Contours

Problem	Probable Causes	Solutions
No contours created.	Variable values on element faces are outside range of palette function value-levels.	Adjust palette function using the Feature Detail Editor (Variables) Summary and Palette section.
	Parent Parts do not contain any 2D elements.	Re-specify Parent Part list.
	Parent Parts do not contain the specified Variable.	Recreate the Variable for the selected Parent Part(s).
Too many contours.	Palette has too many function levels.	Change the number of levels for the palette using the Feature Detail Editor (Variables) Summary and Palette.
	Specified too many sub-contours.	Lower the sub-contour attribute.
Too few contours.	The palette levels do not adequately cover the function value range for the Parent Parts.	Modify the palette using the Feature Detail Editor (Variables) Summary and Palette.
	Sub-contour attribute set to 0.	Modify the Sub-contour attribute.
Contour Part created but (empty)	Parent Part is in Feature Angle representation.	Change Parent Part to 3D border, 2D full representation.



Problem	Probable Causes	Solutions
Contours are fine at first, but later go away.	Parent Parts representation changed to Feature Angle, or Not Loaded.	The contours are created from the Part representation on the EnSight client. Modifying the representation affects the Contour Parts.
Contour parts don't print well	See Display Offset above.	Enter a display offset (may need to be less than zero if viewed from "backside").

## 7.8 Isosurface Create/Update

Isosurfaces are surfaces that follow a constant value of a variable through three-dimensional elements. Hence, isosurfaces are to three-dimensional elements what contour lines are to two-dimensional elements.

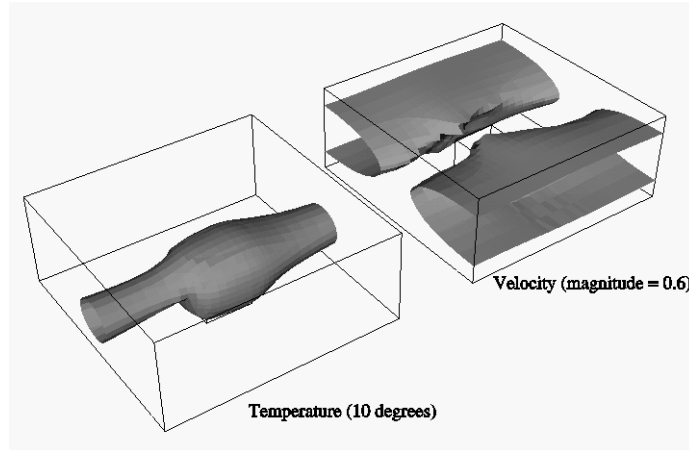

Figure 7-44  
Isosurface Illustration

An isosurface may be based on a vector variable (magnitude or components), or a scalar variable.

At each node of a three-dimensional element, the isosurface's variable has a value. If the range of these values includes the isosurface's isovalue, the isosurface cuts through the element. EnSight draws the isosurface through that element by first determining which edges the isosurface crosses, and then interpolating to find the point on each of those edges corresponding to the isovalue. EnSight connects these points with triangle elements passing through the parent Part elements. If the Parent Part(s) contain two-dimensional elements, a line is created across the elements - just like a contour.

All the triangle elements created inside all the three-dimensional elements of all the parent Part(s) together with all the lines created across the two-dimensional elements of all the Parent Part(s) constitute the isosurface. One-dimensional elements of the parent Part(s) are ignored. Because isosurfaces are generated by the server, the Representation of the parent Part(s) is not important.

You can interactively manipulate the value of an isosurface with a slider allowing you to scan through the min/max range of a variable. This scanning can also be done automatically. The isosurface will change shape as the value is changed.

If you are using animation, you can specify an Animation Delta value by which the isovalue is incremented for each animation frame or page. The isosurface is automatically updated to appear as if it had been newly created at the new location and time.

Clicking once on the Isosurface Create/Update Icon opens the Isosurface Editor in the Quick Interaction Area which is used to both create and update (make changes to) isosurface Parts.



Figure 7-45  
Isosurface Create/Update Icon

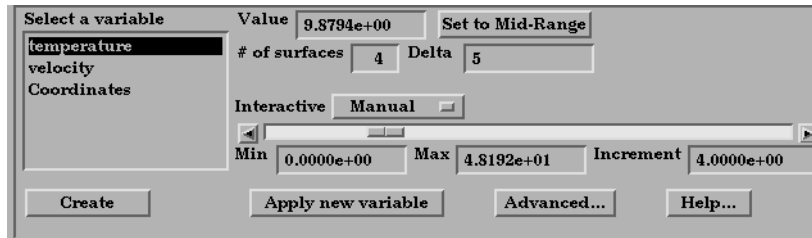



Figure 7-46  
Quick Interaction Area - Isosurface Editor

 Record Button  
(Enabled with active animation playing)

<i>Value</i>	Specification of numerical isovalue of the isosurface. To avoid an empty Part, this value must be in the range of the Variable within the Parent Parts. You can find this range using the Variables dialog or by showing the Legend for the Variable. For vector-variable-based isosurfaces, the vector magnitude is used.
<i>Set to Mid-Range</i>	Clicking this button will put the value that is halfway between the minimum and the maximum variable value.
<i># of surfaces</i>	If you want more than one isosurface calculated at a Delta offset from each other, enter the number of surfaces in this field. This number of isosurfaces are calculated then grouped together. This field is only available the first time the isosurface(s) are calculated. It is not possible to change this value and recalculate the isosurfaces. To change the number or the Delta, they must be deleted and recalculated.
<i>Delta</i>	Offset value to use for creating a number of isosurfaces. The first isosurface is calculated at the number entered in Value, and the next one is Delta + Value, etc.
<i>Interactive</i>	Opens pull-down menu for selection of type of interactive manipulation of the isosurface value. Options are: <ul style="list-style-type: none"> <li>Off            Interactive isosurfaces are turned off.</li> <li>Manual        Value of the isosurface(s) selected are manipulated via the slider bar and the isosurface is interactively updated in the Graphics Window to the new value.</li> <li>Auto            Value of the isosurface is incremented by the Auto Delta value from the minimum range value to the maximum value when the cursor is moved into the Main View. When reaching the maximum it starts again from the minimum.</li> <li>Auto Cycle    Value of the isosurface is incremented by the Auto Increment value from the minimum range value to the maximum value. When reaching the maximum it decrements back to the minimum.</li> </ul>
<i>Record Button</i>	Opens a dialog for recording Interactive Auto or Interactive Auto Cycle animation to a file. This button is enabled when Auto or Auto cycle animation is actively playing.
<i>Min</i>	Specification of the minimum isosurface value for the range used with the “Manual” slider bar and the “Auto” and “Auto Cycle” options.

## 7.8 Isosurface Create/Update

<i>Max</i>	Specification of the maximum isosurface value for the range used with the “Manual” slider and the “Auto” and “Auto Cycle” options.
<i>Increment</i>	Specification of the increment/decrement the slider will move within the min and max, each time the stepper buttons are clicked.
<i>Create</i>	Creates an isosurface Part at the value specified for the variable selected in the Variables List and from the Part(s) selected in the Parts List.
<i>Apply New Variable</i>	Will recreate the isosurface Part at the value specified for the variable currently selected in the Variables List.
<i>Advanced</i>	Will open the Feature Detail Editor and select the Isosurfaces icon for more advance control of the Isosurface Part.

Feature Detail Editor (Isosurfaces) Double clicking on the Isosurface Create/Update Icon opens the Feature Detail Editor (Isosurfaces), the Creation Attributes Section of which provides access to additional features for isosurface creation and modification:

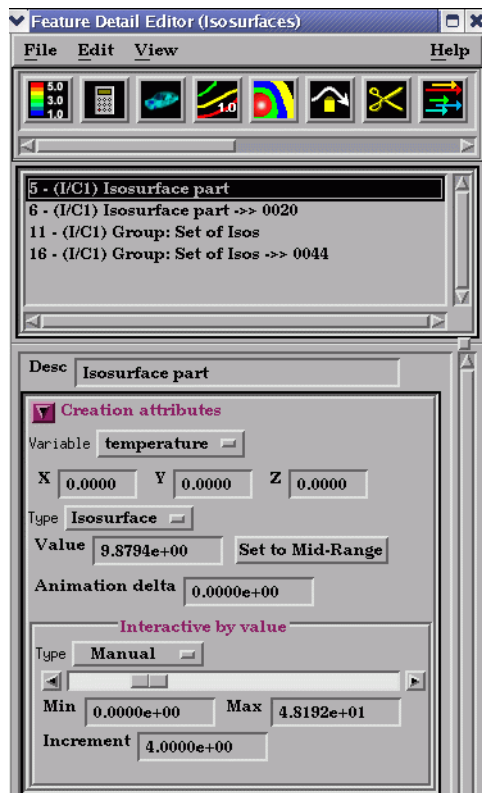

Figure 7-47  
Feature Detail Editor (Isosurfaces) Creation Attributes Area

<i>Variable</i>	Opens a pop-up menu for the selection of an active Variable to use to calculate the isosurface.
<i>X Y Z</i>	These fields specify the vector- component coefficients. When the three fields are set to 0.0000, the vector magnitude is used for the isosurface calculation. Otherwise, the sum of: $(\text{Vector}_x * X) + (\text{Vector}_y * Y) + (\text{Vector}_z * Z)$ is used as the isosurface value.
<i>Type</i> Isosurface	Specification that an Isosurface type part created from the specified Variable and selected parts will have the isovalue of Value for all its elements.

Value	Specification of the numerical isovalue of the Isosurface Part(s) selected in the Feature Detail Editor's Parts List (or if none is selected, of the isosurface you are about to Create)
Set to Mid-Range	Puts the value that is halfway between the minimum and the maximum variable value into the Value Field.



Figure 7-48  
Feature Detail Editor (Isovolume) Creation Attributes Area

Isovolume	Specification that an Isovolume type part created from the specified Variable and selected parts will consist of elements with isovalues constrained to either below a Min, above a Max, or within the specified interval of Min and Max.
Constraint	Specification restricting the element isovalues of the Isovolume Part to an interval. The Constraint options are: <ul style="list-style-type: none"> <li><i>Low</i> all elements of Isovolume Part have isovalues below the specified Min value.</li> <li><i>Band</i> all elements of Isovolume Part have isovalues within the specified Min and Max interval values.</li> <li><i>High</i> all elements of Isovolume Part have isovalues above the specified Max value.</li> </ul>
Min	Specification of the minimum isovalue limit for the Isovolume Part.
Max	Specification of the maximum isovalue limit for the Isovolume Part.
<i>Animation Delta</i>	This field specifies the incremental change in isovalue for each frame or page of animation. It can be negative.  (see <a href="#">Section 7.2, Flipbook Animation</a> and <a href="#">Section 7.3, Keyframe Animation</a> )
<i>Create</i>	(At the bottom of the Feature Detail Editor) Creates an Isosurface Part at the value specified for the variable selected in the Variable pop-up menu of the Creation Attributes section and from the Part(s) selected in the Main Parts List.  The Feature Detail Editor also allows you to make changes in batch; that is, to make several changes to the menus and fields which do not effect the Graphics Window until you click in the Apply Changes button. It is sometimes quicker (with respect to CPU time) to make several changes at once rather than one at a time as in the Quick Interaction Area.  For a detailed discussion of the remaining Feature Detail Editor turn-down sections (which are the same for all Parts):  (see <a href="#">Section 3.3, Part Editing</a> and <a href="#">How To Create Isosurfaces</a> )

## 7.9 Clip Create/Update

A Clip is a straight line (a Clip Line), a plane (a Clip Plane), a quadric surface (cylinder, sphere, etc.), a constant x, y, or z plane, a box, or an i, j, or k plane that passes through selected model Parts (or already created Clips, Isosurface, or Developed Surface Parts). EnSight calculates the values of variables at the nodes of the Clip. Clips can be parent Parts. For example, you can create a Clip Line passing through a vector field, then create vector arrows originating from the nodes of the Clip Line. Clips are created on the server, and so are not affected by the selected Representation(s) of the parent Part(s). If you activate or create variables after creating a Clip, the Clip automatically updates to include them.

You specify the location, orientation, and size of the Clip numerically in the Transformations Editor dialog, or interactively using the Line, Plane, Box, or Quadric surface tool. If you wish, EnSight will automatically extend the size of a Clip Plane to include all the elements of the parent Part(s) that intersect the plane.

For a Clip Line, which is composed of bar elements, you specify how many evenly spaced nodes are along the line. For a grid-type Clip Plane, which is composed of rectangular elements, you specify the number of nodes in each dimension, resulting in an evenly spaced grid of nodes across the plane.

If you request a mesh-type Clip Plane, an xyz clip, or any of the quadric surfaces, EnSight finds the intersection of the specified plane or surface with the selected parent Part(s) and creates elements of various dimensions, sizes, and shapes that together form a cross-section of the parent Part(s). In this cross-section, three-dimensional parent Part elements result in two-dimensional Clip Plane elements, and two-dimensional parent Part elements result in one-dimensional Clip Plane elements. Note that two-dimensional parent Part elements that are coplanar with the cross-section are not included since they do not intersect the plane.

For XYZ, Plane, Quadric and Revolution Clips you can specify the resulting part to be all elements that intersect the specified value - resulting in a “crinkly” surface which can help analyze mesh quality.

For each Clip node on or inside an element of the selected parent Part(s), EnSight calculates the value of each variable by interpolating from the variable’s values at the surrounding nodes of the parent Part(s).

You can interactively manipulate the location of a clip Part by toggling on the Interactive Tool button. When this toggle is on, the tool used to create the clip Part will appear in the Graphics Window. Manipulation of this tool will cause the clip Part to be recreated at the new location. This feature allows you to interactively sweep a plane across your model or manipulate the size and location of the cylinder, sphere, or cone.

You can animate a Clip by specifying an Animation Delta vector that moves the Clip to a new location for each frame or page of the animation. The Clip updates to appear as if it had been newly created at the new location and time.

For structured Parts, you can sweep through the Part with any of the i, j, or k planes.

A Box Clip will create a part according to the Box Tool, and that can either be the intersection of the Box Tool walls with the selected model parts (intersect), the

crinkly intersection of the Box Tool walls with the selected model parts (crinkly), the portion of the selected model parts that lie within the Box Tool (inside), or the portion of the selected model parts which lie outside the Box Tool (outside).

Clicking once on the Clip Create/Update Icon opens the Clip Editor in the Quick interaction Area which is used to both create and update clip Parts.



Figure 7-49  
Clip Create/Update Icon

### Use Tool

#### IJK

The IJK clip tool is used with structured mesh results.

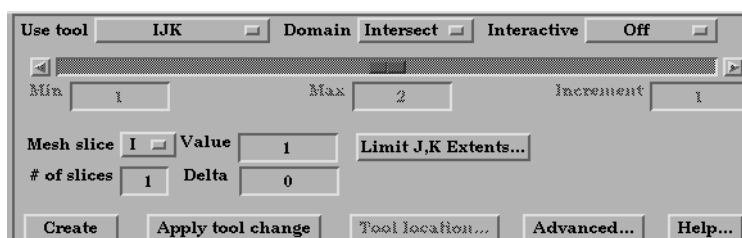

Figure 7-50  
Quick Interaction Area - Clip Editor - IJK tool

Record Button  
(Enabled with active animation playing)

Domain	Specification to extract the intersection of the specified mesh slice values. For IJK clips, the only valid selection is “Intersect”.
Interactive	Opens pull-down menu for selection of type of interactive manipulation of the IJK clip. Options are:
Off	Interactive IJK clips are turned off.
Manual	Value of the IJK clip selected are manipulated via the slider bar and the IJK clip is interactively updated in the Graphics Window to the new value.
Auto	Value of the IJK clip is incremented by the Auto Delta value from the minimum range value to the maximum value. When reaching the maximum it starts again from the minimum.
Auto Cycle	Value of the IJK clip is incremented by the Auto Increment value from the minimum range value to the maximum value. When reaching the maximum it decrements back to the minimum.
Slider Bar	For IJK clips, the slider bar is used to increment / decrement the Mesh Slice Value between its Minimum and Maximum value.
Min	Specification of the minimum slice value for the range used with the “Manual” slider bar and the “Auto” and “Auto Cycle” options.
Max	Specification of the maximum slice value for the range used with the “Manual” slider and the “Auto” and “Auto Cycle” options.
Increment	Specification of the increment/decrement the slider will move within the min and max, each time the stepper buttons are clicked.
Mesh Slice	Opens a pull-down menu for selecting which of the IJK dimensions you wish to allow to change. You will then specify Min, Max and Step limits for the two remaining “fixed” dimensions.

## 7.9 Clip Create/Update

Value	This field specifies the I, J, or K plane desired for the dimension selected in Mesh Slice
Limit IJK Extents	Opens the “Limits Extents of Current Slice By” dialog, in which the off dimension ranges can be limited.
IJK D(2)Min	This field specifies the minimum value for the second fixed dimension.
IJK D(2)Max	This field specifies the maximum value for the second fixed dimension.
IJK D(2) Step	This field specifies the step size through the second fixed dimension.
IJK D(3)Min	This field specifies the minimum value for the third fixed dimension.
IJK D(3)Max	This field specifies the maximum value for the third fixed dimension.
IJK D(3) Step	This field specifies the step size through the third fixed dimension.
Show Parent IJK Part Extents...	Will show the second and third dimension Min and Max extents as defined for the clip parent Part.
# slices	If you want more than one clip calculated at a Delta offset from each other, enter the number of slices in this field. This number of clips is calculated then they are grouped together. This field is only available at the first time the clip(s) are calculated. It is not possible to change this value and recalculate the clips. To change the number or the Delta, they must be deleted and recalculated.
Delta	Offset value to use for creating a number of clips. The first clip is calculated at the number entered in Value, and the next one is Delta + Value, etc. and they are all grouped together in the Main Part List.
Create	Creates the Clip Part in the Graphics Window as specified.
Apply Tool Change	Recreates the Clip Part selected in the Main Parts List at the current position of and of the type specified by Use Tool.
Advanced	Will open the Feature Detail Editor and select the Clip icon for more advance control of the Clip Part.
Record Button	Opens a dialog for recording Interactive Auto or Interactive Auto Cycle animation to a file. This button is enabled when Auto or Auto cycle animation is actively playing.
Feature Detail Editor (Clips) - IJK	Double Clicking on the Clip Create/Update Icon brings up the Feature Detail Editor, the Creation attributes section of which offers the same features for the IJK tool as the Quick Interaction Area Editor. (see <a href="#">Section 3.3, Part Editing</a> for a detailed discussion of the remaining Feature Detail Editor turn-down sections which are the same for all Parts), (see <a href="#">How To Create IJK Clips</a> )

### Use Tool

#### XYZ

The XYZ tool is used to create a planar Part at a constant Cartesian component value that is referenced according to the local frame of the part.

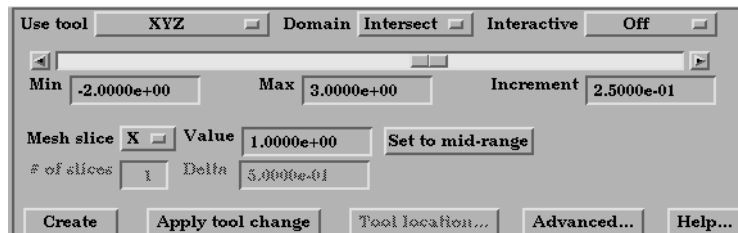

Figure 7-51  
Quick Interaction Area - Clip Editor - XYZ Tool

#### Domain

##### I

*Intersect* will create the cross section of the selected parts at the specified X, Y, or Z plane.



	<i>Crinkly</i>	will create a new part consisting of the parent part elements that intersect the X, Y, or Z plane
Interactive		Opens pull-down menu for selection of type of interactive manipulation of the XYZ clip. Options are:
	Off	Interactive XYZ clips are turned off.
	Manual	Value of the XYZ clip selected are manipulated via the slider bar and the XYZ clip is interactively updated in the Graphics Window to the new value.
	Auto	Value of the XYZ clip is incremented by the Auto Delta value from the minimum range value to the maximum value. When reaching the maximum it starts again from the minimum.
	Auto Cycle	Value of the XYZ clip is incremented by the Auto Increment value from the minimum range value to the maximum value. When reaching the maximum it decrements back to the minimum.
Slider Bar		For XYZ clips, the slider bar is used to increment / decrement the Mesh Slice Value between its Minimum and Maximum value.
	Min	Specification of the minimum interval value of the interactive XYZ clip.
	Max	Specification of the maximum interval value of the interactive XYZ clip.
	Increment	Specification of the interval step of the interactive XYZ clip.
Mesh Slice		Opens a pulldown menu for selecting which of the XYZ components you wish to clip, i.e. the X, the Y, or the Z component.
Value		This field specifies the coordinate desired for the Mesh Slice component.
Set to Mid-Range		Clicking this button will put the value that is halfway between the minimum and the maximum variable value.
# slices		If you want more than one clip calculated at a Delta offset from each other, enter the number of slices in this field. This number of clips is calculated then they are grouped together. This field is only available at the first time the clip(s) are calculated. It is not possible to change this value and recalculate the clips. To change the number or the Delta, they must be deleted and recalculated.
<i>Delta</i>		Offset value to use for creating a number of clips. The first clip is calculated at the number entered in Value, and the next one is Delta + Value, etc. and they are all grouped together in the Main Part List.
Apply Tool Change		Recreates the Clip Part selected in the Main Parts List at the current position of and of the type specified by Use Tool.
Create		Creates the Clip Part in the Graphics Window as specified.
<i>Advanced</i>		Will open the Feature Detail Editor and select the Clip icon for more advance control of the Clip Part.

Feature Detail Editor  
(Clips) - XYZ

Double Clicking on the Clip Create/Update Icon brings up the Feature Detail Editor (Clips), the Creation attributes section of which offers access to the same interactive clip parameters as found in the Quick Interaction Area Editor, along with additional animation delta control of clips using the XYZ tool.

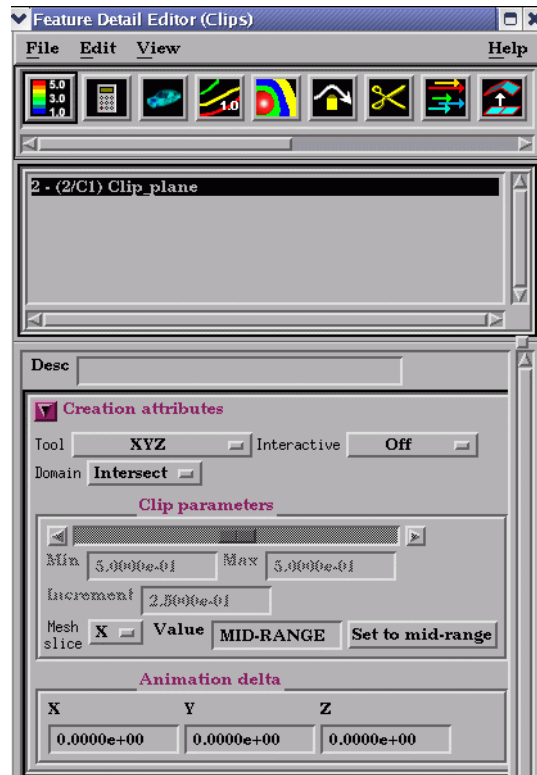

Figure 7-52  
Quick Interaction Area - Clip Editor - XYZ Tool - Creation Attributes

## Animation Delta

These X,Y,Z fields specify the incremental change in position of the clip for each page of Flipbook or frame of Keyframe animation.

(see [Section 3.3, Part Editing](#) for a detailed discussion of the remaining Feature Detail Editor turn-down sections which are the same for all Parts),

(see [How To Create XYZ Clips](#))

## Use Tool

**RTZ**

The RTZ tool is used to create a Part using cylindrical coordinates at a constant radius about an axis, angle around that axis or height along an axis.

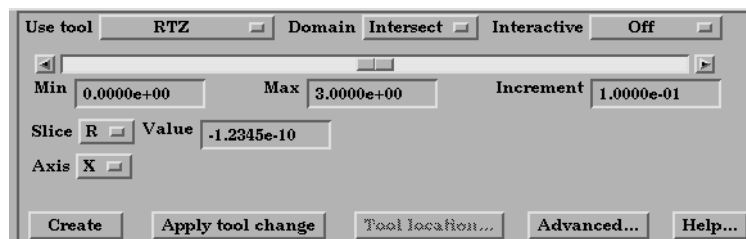

Figure 7-53  
Quick Interaction Area - Clip Editor - RTZ tool

Domain	
Intersect	Will create a cross section of the selected parts at the specified radius, angle, or distance along the axis.
Crinkly	Will create a new part consisting of the parent part elements that intersect the specified radius, angle or distance.
Interactive	Opens pull-down menu for selection of type of interactive manipulation of the RTZ clip. Options are:
Off	Interactive RTZ clips are turned off.
Manual	Value of the RTZ clip selected are manipulated via the slider bar and the RTZ clip is interactively updated in the Graphics Window to the new value.
Auto	Value of the RTZ clip is incremented by the Auto Delta value from the minimum range value to the maximum value. When reaching the maximum it starts again from the minimum.
Auto Cycle	Value of the RTZ clip is incremented by the Auto Increment value from the minimum range value to the maximum value. When reaching the maximum it decrements back to the minimum.
Slider Bar	For RTZ clips, the slider bar is used to increment / decrement the Slice Value between its Minimum and Maximum value.
Min	Specification of the minimum slice value for the range used with the “Manual” slider bar and the “Auto” and “Auto Cycle” options.
Max	Specification of the maximum slice value for the range used with the “Manual” slider and the “Auto” and “Auto Cycle” options.
Increment	Specification of the increment/decrement the slider will move within the min and max, each time the stepper buttons are clicked.
Slice	Opens a pull-down menu for selecting which of the RTZ components to clip, i.e. the radial (R), the angle theta (T) in degrees, or the distance along the longitudinal axis Z, (Z).
Value	This field specifies the magnitude desired for the Slice component, (theta in degrees).
Axis	The global axis with which to align the longitudinal (Z) RTZ axis.
Create	Creates the Clip Part in the Graphics Window as specified.
Advanced	Will open the Feature Detail Editor and select the Clip icon for more advance control of the Clip Part.
Apply Tool Change	Recreates the Clip Part selected in the Main Parts List at the current position of and of the type specified by Use Tool.
Feature Detail Editor (Clips) - RTZ	<p>Double Clicking on the Clip Create/Update Icon brings up the Feature Detail Editor, the Creation attributes section of which offers the same features for the RTZ tool as the Quick Interaction Area Editor.</p> <p>(see <a href="#">Section 3.3, Part Editing</a> for a detailed discussion of the remaining Feature Detail Editor turn-down sections which are the same for all Parts),</p> <p>(see <a href="#">How To Create RTZ Clips</a>)</p>

*Use Tool***Line**

The Line tool is used to create a clip line.

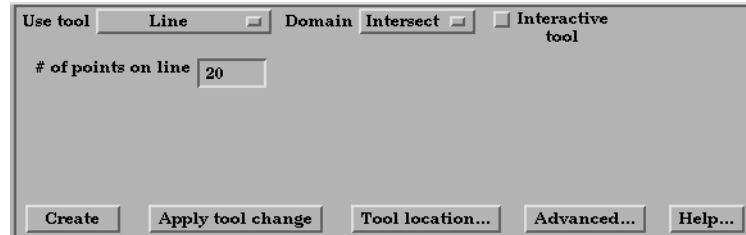

Figure 7-54  
Quick Interaction Area - Clip Editor - Line Tool

Domain	Specification to extract the intersection of the line tool with the selected part(s). For Line clips, the only valid selection is “Intersect”.
Interactive Tool	Toggles on/off interactive movement and updating of a clip Part. When toggled on, the line tool used to create the 2D clip line will appear in the Graphics Window. Movement of the tool will cause the Clip Part to be recreated at the new position. When manipulation of the tool stops, the clip Part and any Parts that are dependent on it will be updated. During movement, the Tool itself will not be visible, so as not to obscure the Line Clip Part. The Tool will reappear when the mouse button is released.
# of Points on Line	Specification of number of evenly spaced points on the line at which to create a node.
Tool Location...	Opens the Transformation Editor dialog to permit precise positioning of the Line Tool within the Graphics Window. (see Tool Positions... Line Tool in <a href="#">Section 6.5, Tools Menu Functions</a> and <a href="#">How To Use the Line Tool</a> )
Apply Tool Change	Recreates the Clip Part selected in the Main Parts List at the current position of and of the type specified by Use Tool.
Create	Creates the Clip Part in the Graphics Window as specified.

Feature Detail Editor  
(Clips) - Line

Double Clicking on the Clip Create/Update Icon brings up the Feature Detail Editor (Clips), the Creation attributes section of which offers access to additional features for the creation and modification of clips using the Line tool.

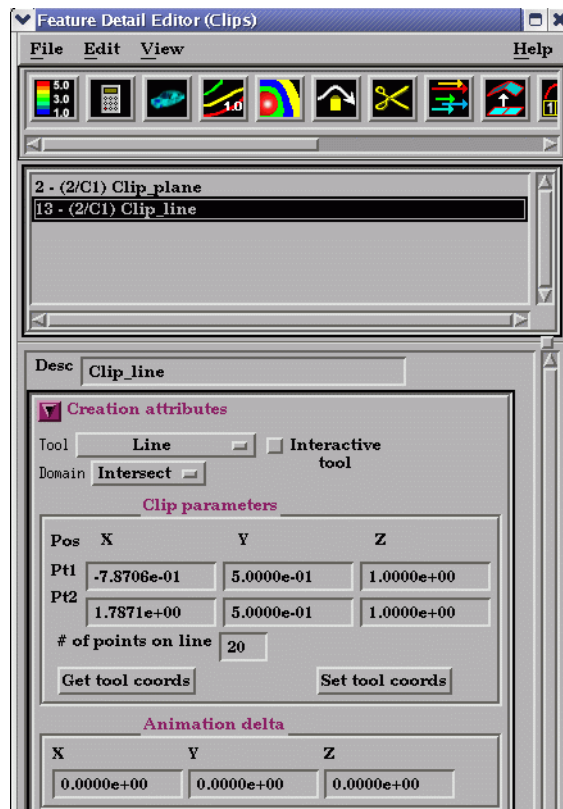

Figure 7-55  
Feature Detail Editor (Clips) - Line Tool  
Creation Attributes

**Clip Parameters**

Pos of Pt1

Specification of XYZ endpoint-coordinates of Line Clip. The position of a Line Clip

Pos of Pt2

Part, if selected in the Feature Detail Editor's Parts List, can be changed by entering values in the numeric fields and then pressing Return.

Set Tool Coords

The position of the Line Clip tool can be changed by entering values in the numeric fields and then pressing Set Tool Coords.

Get Tool Coords

The values in the numeric fields (and the position of a Line Clip Part, if selected in the Feature Detail Editor's Parts List) can be updated after moving the Line tool interactively in the Graphics Window by clicking Get Tool Coords. If a Line Clip Part is selected in the Feature Detail Editor Parts List, it will be repositioned to the new coordinates after clicking Get Tool Coords. Coordinates are always in the original model frame (Frame 0).

**Animation Delta**

These X,Y,Z fields specify the incremental change in position of the clip for each page of Flipbook or frame of Keyframe animation.

The Feature Detail Editor also allows you to make changes in batch; that is, to make several changes to the menus and fields which do not effect the Graphics Window until you click in the Apply Changes button. It is sometimes quicker (with respect to CPU time) to make several changes at once rather than one at a time as in the Quick Interaction Area.

(see [Section 3.3, Part Editing](#) for a detailed discussion of the remaining Feature Detail Editor turn-down sections which are the same for all Parts),

(see [How To Create Line Clips](#))

*Use Tool***Plane**

The Plane Tool is used to create a Plane Clip.

**Domain**

*Intersect* will create the cross section of the selected parts where they intersect the plane tool.

*Crinkly* will create a new part consisting of the parent part elements that intersect the plane tool.

*Inside* will cut the parent parts and create a new part consisting of the portion on the positive z side of the plane tool.

*Outside* will cut the parent parts and create a new part consisting of the portion on the negative z side of the plane tool.

*In/Out* will cut the parent parts and create two new parts - namely an *Inside* and *Outside* part.

**Plane Type****Mesh**

Will create a Plane Clip showing the cross section of the parent Part.

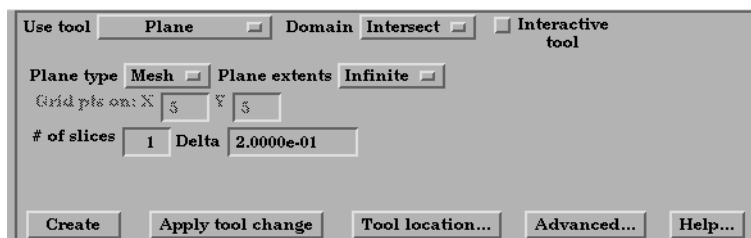

Figure 7-56

Quick Interaction Area - Clip Editor - Plane Tool - Mesh Type

**Plane Extents**

Opens a pull down menu for selection of the extent of the Plane Clip.

*Finite* limits the Plane Clip to the area specified by the Plane Tool corner coordinates.

*Infinite* extends the Plane Clip to include the intersection of the plane with all elements of the selected model Parts.

**Grid**

Will create a Plane Clip by discrete point sampling.

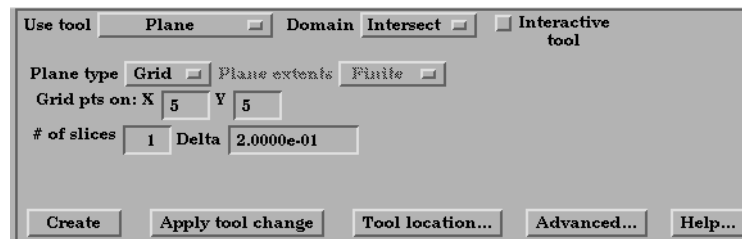

Figure 7-57

Quick Interaction Area - Clip Editor - Plane Tool - Grid Type

**Grid Pts on:XY**

These fields specify the number of points on each edge of a Plane Clip at which to create nodes. Additional nodes are located in the interior of the plane to form an evenly spaced grid. The values must be positive integers. Applicable only to grid-type Plane Clips. Grid Pts in X correspond to the x-direction on the Plane tool, while the number of Grid Pts in Y correspond to the y-direction of the Plane tool.

**# slices**

If you want more than one clip calculated at a Delta offset from each other, enter the number of slices in this field. This number of clips is calculated then they are grouped together. This field is only available at the first time the clip(s) are calculated. It is not possible to change this value and recalculate the clips. To change the number or the Delta, they must be deleted and recalculated.

**Delta**

Offset value to use for creating a number of clips. The first clip is calculated at the number entered in Value, and the next one is Delta + Value, etc. and they are all grouped together in the Main Part List.

Apply Tool Change	Recreates the Clip Part selected in the Main Parts List at the current position of and of the type specified by Use Tool.
Interactive Tool	Toggles on/off interactive movement and updating of the clip Part. When toggled on, the Plane Tool used to create the clip Part will appear in the Graphics Window. Movement of the Plane Tool will cause the Plane Clip to be recreated at the new position. When manipulation of the tool stops, the clip Part and any Parts that are dependent on it will be updated. During movement, the Tool itself will not be visible, so as not to obscure the Line Clip Part. The Tool will reappear when the mouse button is released.
Tool Location...	Opens the Transformation Editor dialog to permit precise positioning of the Plane Tool. (see Section 6.5, Tools Menu Functions and How To Use the Plane Tool)
Create	Creates the Clip Part in the Graphics Window as specified.
<i>Advanced</i>	Will open the Feature Detail Editor and select the Clip icon for more advance control of the Clip Part.
Feature Detail Editor (Clips) - Plane	Double Clicking on the Clip Create/Update Icon brings up the Feature Detail Editor (Clips), the Creation attributes section of which offers access to additional features for the creation and modification of clips using the Plane tool.

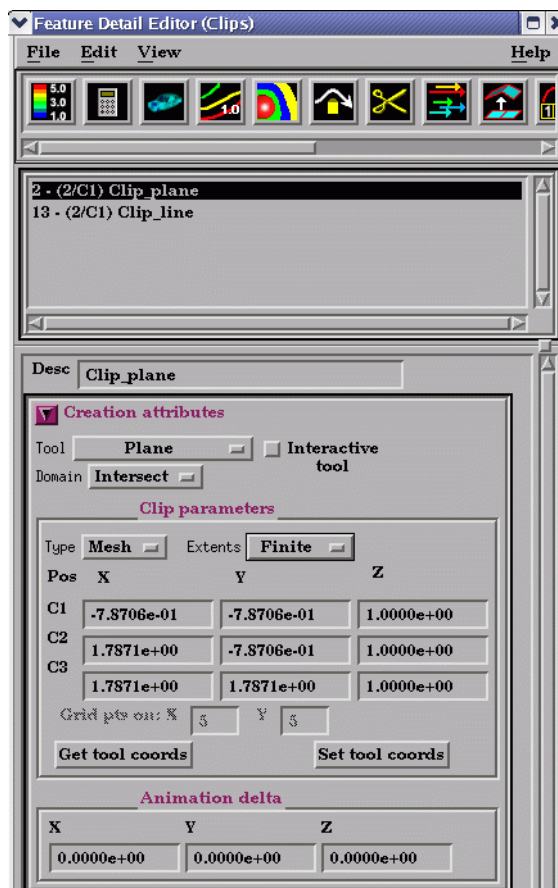

Figure 7-58  
Feature Detail Editor (Clips) - Plane Tool Creation Attributes

#### Clip Parameters

Pos of C1  
Pos of C2  
Pos of C3

Specification of the location, orientation, and size of the Plane Clip using the coordinates (in the Parts reference frame) of three corner points, as follows:

- Corner 1 is corner located in negative-X negative-Y quadrant
- Corner 2 is corner located in positive-X negative-Y quadrant
- Corner 3 is corner located in positive-X positive-Y quadrant

## 7.9 Clip Create/Update

Set Tool Coords	Will reposition the Plane Tool to the position specified in C1, C2, and C3.
Get Tool Coords	Will update the C1, C2, and C3 fields to reflect the current position of the Plane Tool.
<i>Animation Delta</i>	These X,Y,Z fields specify the incremental change in position of the clip for each page of Flipbook or frame of Keyframe animation.

(see [Section 3.3, Part Editing](#) for a detailed discussion of the remaining Feature Detail Editor turn-down sections which are the same for all Parts),

(see [How To Create Plane Clips](#))

### Use Tool

<b>Box</b>	This Clipping Tool extracts portions of the model that are inside, outside, or that intersect a specified box.
------------	--

*Be aware that due to the algorithm used, this clip can (and most often does) have **chamfered edges**, the size of which depends on the coarseness of the model elements.*

<i>Domain</i>	<i>Intersect</i>	will create a new part consisting of the intersection of the box tool sides and the selected parts.
	<i>Crinkly</i>	will create a new part consisting of the parent part elements that intersect the box tool sides.
	<i>Inside</i>	will extract the volume portion of the parent parts that lie within the box.
	<i>Outside</i>	will extract the volume portion of the parent parts that do not lie within the box.
	<i>In/Out</i>	will create two new parts - namely the <i>Inside</i> and <i>Outside</i> parts.

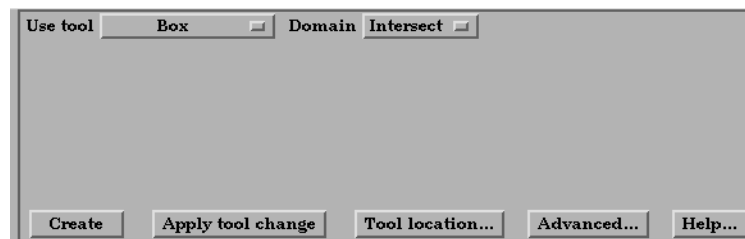

Figure 7-59  
Quick Interaction Area - Clip Editor - Box Tool

Apply Tool Change	Recreates the Clip Part selected in the Main Parts List at the current position of and of the type specified by Use Tool.
Tool Location...	Opens the Transformation Editor dialog to permit precise positioning of the Box Tool. (see <a href="#">Section 6.5, Tools Menu Functions</a> and <a href="#">How To Use the Box Tool</a> )
<i>Advanced</i>	Will open the Feature Detail Editor and select the Clip icon for more advance control of the Clip Part.
Create	Creates the Clip Part in the Graphics Window as specified.
Feature Detail Editor (Clips) - Box	Double Clicking on the Clip Create/Update Icon brings up the Feature Detail Editor, the Creation attributes section of which offers the same features for the Box tool as the Quick Interaction Area Editor.

(see [Section 3.3, Part Editing](#) for a detailed discussion of the remaining Feature Detail Editor turn-down sections which are the same for all Parts),

(see [How To Create Box Clips](#))



## Use Tool

**Cylinder, Sphere, Cone** These Tools are used to create a quadric clip surface.

<i>Domain</i>	<i>Intersect</i>	will create the cross section of the selected parts where they intersect the quadric tool.
	<i>Crinkly</i>	will create a new part consisting of the parent part elements that intersect the quadric tool.
	<i>Inside</i>	will cut the parent parts and create a new part consisting of the portion on the inside of the quadric tool.
	<i>Outside</i>	will cut the parent parts and create a new part consisting of the portion on the outside of the quadric tool.
	<i>In/Out</i>	will cut the parent parts and create two new parts - namely an <i>Inside</i> and <i>Outside</i> part.

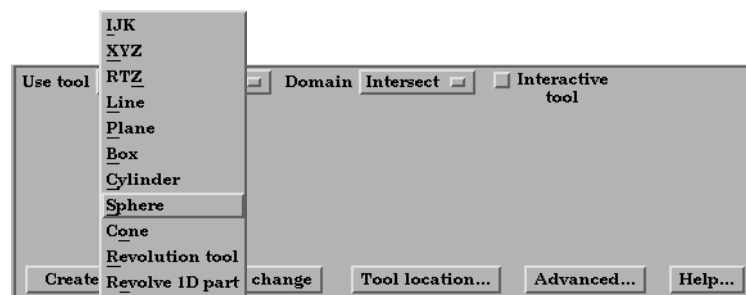

Figure 7-60

Quick Interaction Area - Clip Editor - Cylinder, Sphere, &amp; Cone Tools

Interactive Tool	Toggles on/off interactive movement and updating of a clip Part. When toggled on, the Quadric Tool used to create the Clip Part will appear in the Graphics Window at the location of the Clip Part. Movement of the Quadric Tool will cause the Clip Part to be recreated at the new position. When manipulation of the tool stops, the Clip Part and any Parts that are dependent on it will be updated. During movement, the Tool itself will not be visible, so as not to obscure the Line Clip Part. The Tool will reappear when the mouse button is released.
Advanced	Will open the Feature Detail Editor and select the Clip icon for more advance control of the Clip Part.
Tool Location...	Opens the Transformation Editor dialog to permit precise positioning of Quadric Tools.(see Section 6.5, <a href="#">Tools Menu Functions</a> and <a href="#">How To Use the Cylinder Tool</a> , <a href="#">How To Use the Sphere Tool</a> , and <a href="#">How To Use the Cone Tool</a> )
Apply Tool Change	Recreates the Clip Part selected in the Main Parts List at the current position of and of the type specified by Use Tool.
Create	Creates the Clip Part in the Graphics Window as specified.

Feature Detail Editor (Clips) Quadric Tool

Double Clicking on the Clip Create/Update Icon brings up the Feature Detail Editor (Clips), the Creation attributes section of which offers access to additional features for the creation and modification of clips using the Quadric tools.

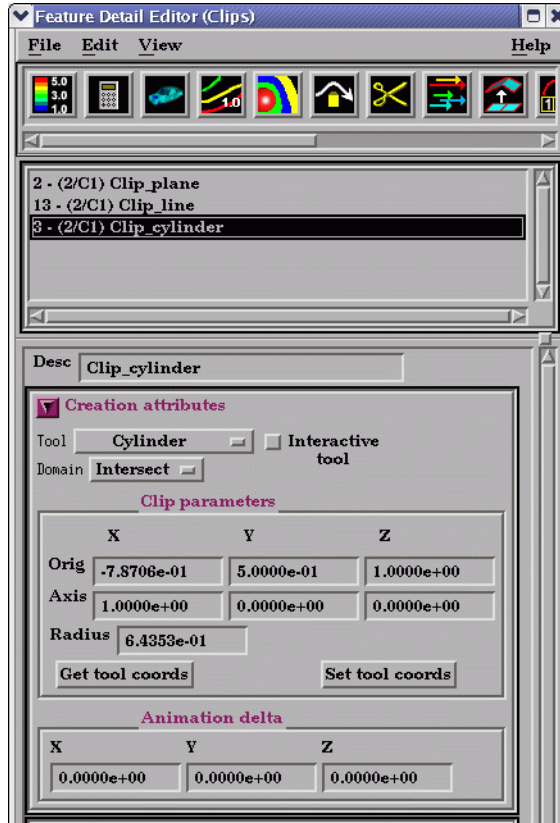

Figure 7-61  
Feature Detail Editor (Clips) - Quadric Tool Creation Attributes

*Clip Parameters*

Cylinder

- Orig XYZ Specification of the origin (the center point) of the Cylindrical Clip.
- Axis Specification of the longitudinal axis direction of the Cylindrical Clip.
- Radius Specification of the radius of the Cylindrical Clip.

Sphere

- Orig Specification of the origin (the center point) of the Spherical Clip.
- Axis Specification of the axis direction of the Spherical Clip. *(Note: Axis is important if Developed Surface is created from the spherical clip.)*
- Radius Specification of the radius of the Spherical Clip.

Cone

- Orig Specification of the origin (the tip of the cone) of the Conical Clip.
- Axis Specification of the axis direction of the Conical Clip. Axis direction goes from tip to base.
- Angle Specification of the conical half angle (in degrees) of the Conical Clip.

Set Tool Coords

Will reposition the Quadric Tool to the position specified in the Clip Parameter fields.

Get Tool Coords

Will update the Clip Parameter fields to reflect the current position of the Quadric Tool.

*Animation Delta*

These X,Y,Z fields specify the incremental change in position of the clip for each page of Flipbook or frame of Keyframe animation.

The Feature Detail Editor also allows you to make changes in batch; that is, to make several changes to the menus and fields which do not effect the Graphics Window until you click in the Apply Changes button. It is sometimes quicker (with respect to CPU time) to make several changes at once rather than one at a time as in the Quick Interaction Area.

(see [Section 3.3, Part Editing](#) for a detailed discussion of the remaining Feature Detail Editor turn-down sections which are the same for all Parts),

(see [How To Create Quadric Clips](#))

*Use Tool***Revolution Tool**

This clipping Tool is used to create custom clip surfaces which are defined by revolving a set of lines about a defined axis.



Figure 7-62  
Quick Interaction Area - Clip Editor - Revolution Tool

*Domain*

*Intersect* will create the cross section of the selected parts where they intersect the revolved surface.

*Crinkly* will create a new part consisting of the parent part elements that intersect the revolved surface.

*Inside* will cut the parent parts and create a new part consisting of the portion on the inside of the revolved surface.

*Outside* will cut the parent parts and create a new part consisting of the portion on the outside of the revolved surface.

*In/Out* will cut the parent parts and create two new parts - namely an *Inside* and *Outside* part.

## Tool Location...

Opens the Transformation Editor dialog to permit precise location of the revolution tool within the Graphics Window. It is here where you also can control the number and positioning of the set of lines which make up the tool.

(see [Section 6.5, Tools Menu Functions](#) and [How To Use the Surface of Revolution Tool](#))

## Advanced

Will open the Feature Detail Editor and select the Clip icon for more advance control of the Clip Part.

## Apply Tool Change

Recreates the Clip Part selected in the Main Parts List at the current position of and of the type specified by Use Tool.

## Create

Creates the Clip Part in the Graphics Window as specified.

Feature Detail Editor (Clips) - Revolution Tool

Double Clicking on the Clip Create/Update Icon brings up the Feature Detail Editor (Clips), the Creation attributes section of which offers access to additional features for the creation and modification of clips using the Revolution tool.

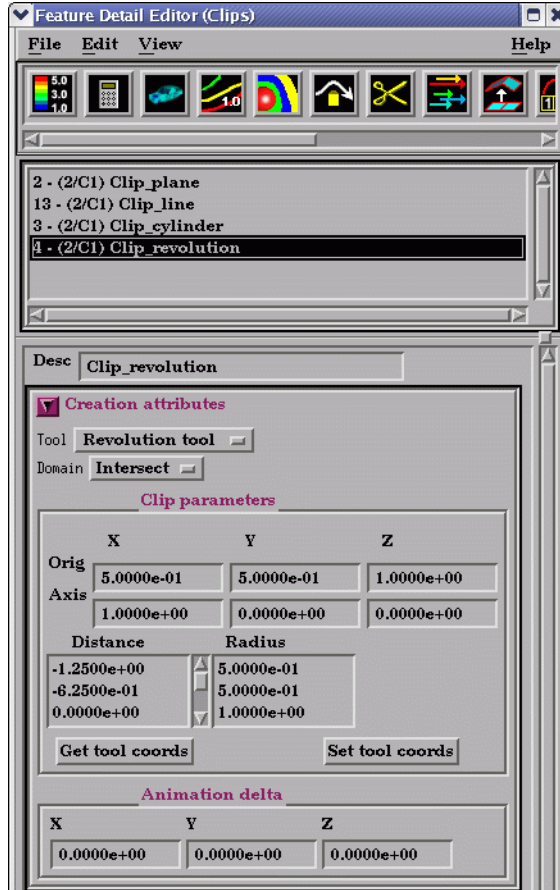

Figure 7-63  
Feature Detail Editor (Clips) - Revolution Tool Creation Attributes

*Revolution Tool Clip Parameters*

- Orig** Specify the XYZ coordinates of the origin (center point) of the Revolution Clip.
- Axis** These fields specify the XYZ coordinates of the axis direction of the Revolution Clip.
- Distance/Radius** These lists specify the distance (from the origin) and radius for each point that defines the Revolution Clip. The points can Not be edited within this dialog. You must edit the Revolution Tool in the Transformations dialog.
- Set Tool Coords** Will reposition the Revolution Tool to the position specified in the Clip Parameter fields.
- Get Tool Coords** Will update the Clip Parameter fields to reflect the current position of the Revolution Tool.
- Animation Delta** These X,Y,Z fields specify the incremental change in position of the clip for each page of Flipbook or frame of Keyframe animation.

The Feature Detail Editor also allows you to make changes in batch; that is, to make several changes to the menus and fields which do not effect the Graphics Window until you click in the Apply Changes button. It is sometimes quicker (with respect to CPU time) to make several changes at once rather than one at a time as in the Quick Interaction Area.

(see Section 3.3, Part Editing for a detailed discussion of the remaining Feature Detail Editor turn-down sections which are the same for all Parts),

(see Section 6.5, Tools Menu Functions and How To Use the Surface of Revolution Tool)

*Use Tool***Revolve 1D Part**

This option will create a clip surface by revolving a line, defined by a Part, about an axis.

	X	Y	Z
Orig	0.0000e+00	0.0000e+00	0.0000e+00
Axis	1.0000e+00	0.0000e+00	0.0000e+00

Figure 7-64  
Quick Interaction Area - Revolve 1D Part Clip Editor

*Domain*

- Intersect* will create the cross section of the selected parts where they intersect the revolved surface.
- Crinkly* will create a new part consisting of the parent part elements that intersect the revolved surface.
- Inside* will cut the parent parts and create a new part consisting of the portion on the inside of the revolved surface.
- Outside* will cut the parent parts and create a new part consisting of the portion on the outside of the revolved surface.
- In/Out* will cut the parent parts and create two new parts - namely an *Inside* and *Outside* part.

## Revolve Part

This field specifies the Part number which will be revolved. The 1D Part must contain only bar elements and must have only two free ends (i.e., there must be only one “logical” line contained in the Part).

## Orig

These fields specify the XYZ coordinates of the axis line origin point.

## Axis

These fields specify the direction vector of the axis line. The “line” contained in the Part specified by number in Revolve Part will be revolved about this axis to create the clip surface Part.

## Apply Tool Change

Recreates the Clip Part selected in the Main Parts List at the current position of and of the type specified by Use Tool.

## Create

Creates the Clip Part in the Graphics Window as specified.

**General Quadric**

Feature Detail Editor Double Clicking on the Clip Create/Update Icon brings up the Feature Detail Editor (Clips), the Creation attributes section of which offers access to one type of clip creation which is not available in the Quick Interaction area. It is possible to create a 3D Quadric clip using the General Quadric option by directly specifying the coefficients of a general quadric equation.

The Feature Detail Editor also allows you to make changes in batch; that is, to make several changes to the menus and fields which do not affect the Graphics Window until you click in the Apply Changes button. It is sometimes quicker (with respect to CPU time) to make several changes at once rather than one at a time as in the Quick Interaction Area.

(see Section 3.3, Part Editing for a detailed discussion of the remaining Feature Detail Editor turn-down sections which are the same for all Parts)

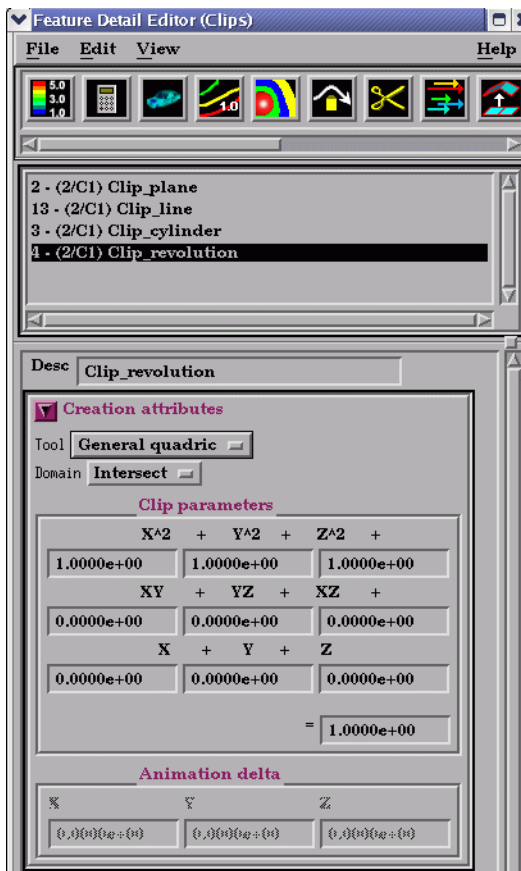

Figure 7-65  
Feature Detail Editor (Clips) - Revolve 1D Part Creation Attributes

**10 coefficient values** These coefficient values represent the general equation of a Quadric surface. They can be changed by modifying the values. No tool exists corresponding to this equation.

$$AX^2+BY^2+CZ^2+DXY+EYZ+FXZ+GX+HY+IZ=J$$

**Animation Delta** Not available for General Quadric Clips.

The Feature Detail Editor also allows you to make changes in batch; that is, to make several changes to the menus and fields which do not effect the Graphics Window until you click in the Apply Changes button. It is sometimes quicker

(with respect to CPU time) to make several changes at once rather than one at a time as in the Quick Interaction Area.

(see [Section 3.3, Part Editing](#) for a detailed discussion of the remaining Feature Detail Editor turn-down sections which are the same for all Parts),

### *Troubleshooting Clips*

Problem	Probable Causes	Solutions
Clip does not move during animation	Animation deltas are not set, or are too small.	Change the animation delta values.
Clip results in an empty Part.	Clip was taken outside of the model.	Change the clip Tool location.

## 7.10 Vector Arrow Create/Update

Vector Arrows visualize the magnitude and direction of a vector variable at discrete points (at nodes, element vertices, or at the center of elements).

Other features can visualize magnitude, but Vector Arrows also show direction.

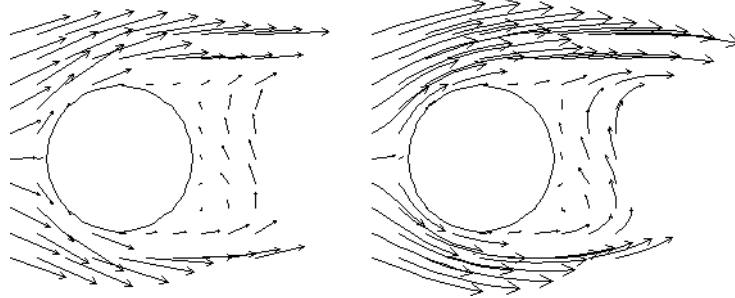

Vector arrow Parts are dependent Parts known only to the client. They cannot be used as a parent Part for other Part types and cannot be used in queries. As dependent Parts, they are updated anytime the parent Part and/or the creation vector variable changes (unless the general attribute Active flag is off).

Vector arrows can be filtered according to low and/or high threshold values.

Vector arrows can emanate from the available nodes of the parent Part(s), the available element vertex nodes of the parent Part(s), or the available element centers of the parent Part(s) which pass through the filter successfully. The nodes and elements available in the parent Part are based on the visual Representation of the Part. Thus, for a border Representation of a Part, only the border elements and associated nodes are candidates.

Vector arrows can have straight shafts representing the vector at the originating location, or be the segment of a streamline emanating from the originating location (curved). Straight vector arrows are displayed relatively quickly, while curved vector arrows can be time consuming.

Different tip styles, sizes, and colors can be used to enhance vector arrow display.

Clicking once on the Vector Arrow Create/Update Icon opens the Vector Arrow Editor section of the Quick interaction Area which is used to both create and update (make changes to) vector arrow Parts.



Figure 7-66  
Vector Arrow Create/Update Icon

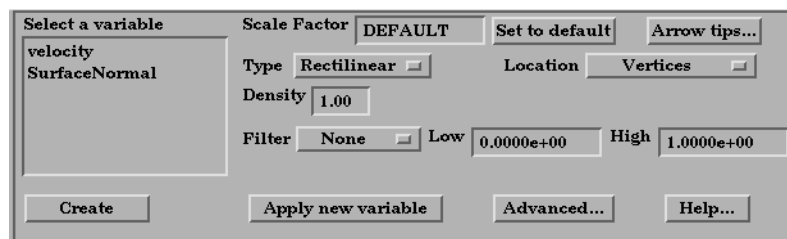

Figure 7-67  
Quick Interaction Area - Vector Arrow Editor



**Scale Factor / Time** When Type is “Rectilinear”, this field specifies a scale factor to apply to the vector values before displaying them. Scaling is usually necessary to control the visual length of the vector arrows since the vector values may not relate well to the geometric dimensions. Can be negative, causing the vector arrows to reverse direction.

When Type is “Rect. Fixed”, this field specifies the length of the arrows in units of the model coordinate system. Can be negative, causing the vector arrows to reverse direction.

When Type is “Curved”, this field specifies the duration time for streamlines forming the shaft of curved vector arrows. Is an indication of the length of the curved vector arrow.

**Set to Default** Sets Scale Factor value to a computed reasonable value based on the vector variable values and the geometry.

**Arrow Tips...** Opens the Vector Arrow Tip Settings dialog.

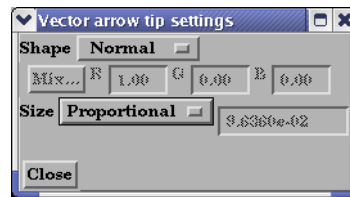

Figure 7-68  
Vector Arrow Tip Settings dialog

**Shape** Opens a pop-up menu to select tip shape.

- None* option displays arrows as lines without tips.
- Cone* arrows have a tip composed of a 3D cone. Good for both 2D and 3D fields.
- Normal* arrows have two short line tips, similar to the way many people draw arrows by hand. The tip will lie in the X–Y, X–Z, or Y–Z plane depending on the relative magnitudes of the X, Y, and Z components of each individual vector. Suggested for 2D problems.
- Triangles* arrows have a tip composed of two intersecting triangles in the two dominant planes. Good for both 2D and 3D fields.
- Tipped* arrows display the tip of the arrow in any user specified color. Good for both 2D and 3D fields. The color may be specified in the RGB fields or chosen from the Color Selector dialog which is opened by pressing the Mix... button

**Size** Opens a pop-up menu for selecting tip size.

- Fixed* sized arrows have tips for which the length is specified in the data entry field to the right of the pop-up menu button. Units are in the model coordinate system.
- Proportional* sized arrow tips change proportionally to the change in the magnitude of the vector arrows.

**Type** Opens a pop-up menu for selection of shaft-type of vector arrows. Options are:

- Rectilinear* arrows have straight shafts. The arrow points in the direction of the vector at the originating location. The length of the arrow shaft is determined by multiplying the vector magnitude by the scale factor.
- Rect. Fixed* arrows have straight shafts. The arrow points in the direction of the vector at the originating location. The length of the arrow shaft is determined by the scale factor. It is independent of the vector variable.

	<i>Curved</i>	arrows have curved shafts. The arrow is actually a streamline emanating from the originating location. It represents the path that a massless Particle would follow if the flow field was steady state. For this option, the “Scale Factor” changes to “Time”. Time is the amount of time the streamline is allowed to take and is an indication of how long the arrow will be. Hint: Since curved arrows can take a significant amount of time (depending on the number of originating locations), the setting of a proper “Time” value is critical. The best way to do this is to first do a single Particle trace at a representative location with the estimated “Time” value as the Max Time. A quick iteration or two on the value here could save considerable time for the curved vector arrow computation.
<i>Location</i>		Opens a pop-up dialog for the selection of root-location of arrow shafts. The options are:
	<i>Node</i>	arrows originate from each node of the parent Part(s). Note: Discrete Particles Parts must use Node option.
	<i>Vertices</i>	arrows originate only from those nodes at the vertices of each element of the parent Part(s) (i.e., arrows are not displayed at free nodes or mid-side nodes).
	<i>Element Center</i>	arrows originate from the geometric center of each element of the parent Part(s).
<i>Density</i>		The fraction of the parent’s nodes/elements which will show a vector arrow. A value of 1.0 will result in a vector arrow at each node/element, while a value of 0.0 will result in no arrows. If between these two values, the arrows will be distributed randomly at the specified density. There is no check for duplicates in the random distribution of arrows. It is entirely possible that when you specify a density of 0.25 in a model containing 100 nodes you only get 15 unique locations with 10 duplicates. It will appear that only 15 arrows show up, but there are actually 25 with 10 duplicates.
<i>Filter</i>		Selection of pattern for filtering Vector Arrows according to magnitude. Options are:
	<i>None</i>	displays all the vector arrows. No filtering done.
	<i>Low</i>	displays only those arrows with magnitude above that specified in the Low field. Filters low values out.
	<i>Band</i>	displays only those arrows with magnitude below that specified in the Low field and above that specified in the High field. Filters the band out.
	<i>High</i>	displays only those arrows with magnitude below that specified in the High field. Filters the high values out.
	<i>Low_High</i>	displays only those arrows with magnitude between that specified in the Low field and that specified in the High field. Filters out low and high values.
<i>Apply New Variable</i>		Changes the vector Variable used to create the Vector Arrows to that currently selected in the Variables List.
<i>Advanced</i>		Will open the Feature Detail Editor and select the Vector Arrow icon for more advance control of the Vector Arrow Part.

Feature Detail Editor  
(Vector Arrows)

Double clicking on the Vector Arrow Create/Update Icon opens the Feature Detail Editor for Vector Arrows, the Creation Attributes Section of which provides access to the functions available in the Quick Interaction Area plus three more:

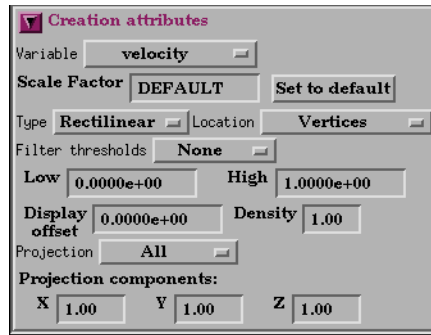

Figure 7-69  
Feature Detail Editor (Vector Arrows)

#### Display offset

This field specifies the normal distance away from a surface to display the vector arrows. A positive value moves the vector arrows away from the surface in the direction of the surface normal.

*Please note that there is a hardware offset that will apply to contours, vector arrows, separation/attachment lines, and surface restricted particle traces that can be turned on or off in the View portion of Edit->Preferences. This preference (“Use graphics hardware to offset line objects...”) is on by default and generally gives good images for everything except move/draw printing. This hardware offset differs from the display offset in that it is in the direction perpendicular to the computer screen monitor (Z-buffer).*

Thus, for viewing, you may generally leave the display offset at zero. But for printing, a non-zero value may become necessary so the arrows print cleanly.

#### Projection

Opens a pop-up menu to allow selection of which vector components to include when calculating both the direction and magnitude of the vector arrows. The vector components at the originating point are always first multiplied by the Projection Components (see below). Then one of the following options is applied:

*All* to display a vector arrow composed of the Projection-Component-modified X, Y, and Z components.

*Normal* to display a vector which is the projection of the All vector in the direction of the normal at the originating location.

*Tangential* to display a vector which is the projection of the All vector into the tangential plane at the originating location.

*Component* to display both the Normal and the Tangential vectors.

The *All*, *Normal*, and *Tangential* options produce a single vector per location, while the *Component* option produces two vectors per location. If selection is not applicable to a Particular element, that element’s vector arrow uses the *All* projection.

#### Projection Components X Y Z

These fields specify a scaling factor for each coordinate component of each vector arrow used in calculating both the magnitude and direction of the vector arrow. Specify 1 to use the full value of a component. Specify 0 to ignore the corresponding vector component (and thus confine all the vector arrows to planes perpendicular to that axis). Values between 0 and 1 diminish the contribution of the corresponding component, while values greater than 1 exaggerate them. Negative values reverse the direction of the component. Always applied before the Projection options above.

The Feature Detail Editor also allows you to make changes in batch; that is, to make several changes to the menus and fields which do not effect the Graphics Window until you click in the Apply Changes button. It is sometimes quicker (with respect to CPU time) to make several changes at once rather than one at a time as in the Quick Interaction Area.

(see [Section 3.3, Part Editing](#) for a detailed discussion of the remaining Feature Detail Editor turn-down sections which are the same for all Parts),

(see [How to Create Vector Arrows](#))

### *Troubleshooting Vector Arrows*

Problem	Probable Causes	Solutions
Vector arrows do not match up with their originating locations on one or more of the parent Parts.	Displacements are on for some of the parent Parts, but not others. Or the parent Parts have been assigned to different coordinate frames	Create separate vector arrow Parts for the parents that will be displaced (or assigned to different frame) and the ones that will not be displaced (or assigned to different frames).
You are displaying several different vector arrow Parts at once and can't tell which is which.	Just too much similar information in the same area.	Use different attributes for the different vector arrow Parts, or better yet, display the conflicting vector arrow Parts on separate Part copies which have been moved apart.
You are trying to display vector arrows on a Discrete Particle Part, but can't get them to show up	Arrow Location set to Vertices (the default).  No vector data provided for the Discrete Particle dataset, thus values all set to zero when read into EnSight.	Set the Arrow Location to Nodes.  Provide vector data for the particles. Specify in the Measured results file. See Section 3.7.
Vector arrows do not print well	See Display Offset discussion above.	Enter a non-zero Display Offset.

## 7.11 Particle Trace Create/Update

A *Particle trace* visualizes a vector field by displaying the path that a massless Particle would follow if placed in that field. At each point on the Particle trace, the direction of the trace is parallel to the vector field at that point and time.

A *streamline* is a Particle trace in a steady-state vector field, while a *pathline* is a Particle trace in a time-varying vector field. Particle traces can be lines or “ribbons” (that additionally visualize the rotation of the vector field around the path of the trace).

EnSight is capable of computing a pathline through a model with changing coordinates and/or changing connectivity. The variable values are assumed to behave linearly between the known timesteps.

Particle Trace Parts have their own attributes, so you can, for example, trace a flow field using the velocity variable, and then color the resulting trace using the temperature variable.

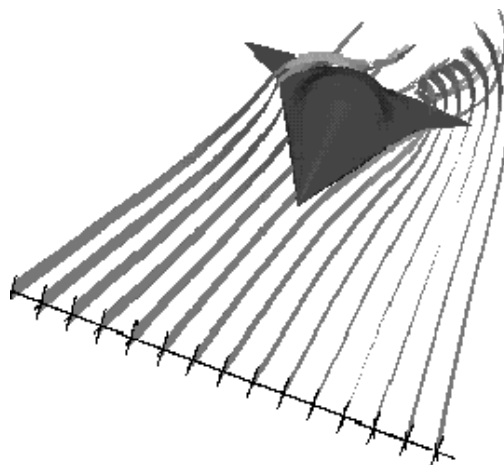

Figure 7-70  
Particle Trace Illustration

### *Emitters*

A Particle Trace Part consists of one or more Particle traces originating from points on one or more *emitters*. Each emitter is capable of emitting a Particle starting at a specified time and continuing to emit Particles at given intervals. When pathlines are generated with emitters emitting at multiple time intervals and these traces are then animated, *streaklines* are displayed.

Emitters consist of single points, points along a line, points forming a grid in a plane, or points corresponding to the nodes of a Part. You can define emitters using the Cursor tool, the Line tool, the Plane tool, or a Part.

Emitters can be created using the cursor, line, and plane tools, using existing Part nodes, or can be created in a surface restricted mode where the mouse can be used to project points, rakes or nets directly onto the displayed surfaces of the model.

Pathlines, of course, must be drawn forward in time, but streamlines can be drawn forward in time, backward in time, or both. Each Particle trace terminates when either (1) the Particle trace moves outside the space in which the vector field is defined, (2) a user-specified time limit is reached, (3) the massless Particle becomes stationary in a place where the vector field is zero, or (4) the last transient-data time step is reached. (4 applies only to pathlines)

A Particle trace can pass through any point inside an element of the parent Part(s). The vector field at any point is calculated from the shape function of the containing element. Emitter points located outside the elements are ignored when creating Particle traces.

*Surface-Restricted Traces*

A surface-restricted Particle trace is constrained to the surface of the selected Part(s) by using only the tangential component of the velocity. The velocity values for this type of trace can be the velocity at the surface (if nonzero) or at some user specified offset into the velocity field.

*Interactive Traces*

A Particle trace can be updated interactively by entering interactive mode and moving the tool used to create the emitter. When a trace is selected and interactive emitter is turned on, the tool will appear at the location of the emitter. The user then manipulates the tool interactively in the Graphics Window or using the transformations dialog. (This option is not available for surface-restricted Particle traces or traces emitted from a Part).

*Integration Method*

EnSight creates Particle traces by integrating the vector field variable over time using a Fourth Order Runge-Kutta method and utilizing a time varying integration step. The integration step is lengthened or shortened depending on the flow field, but you can control the minimum number of integration steps performed in any element as well as other time step controls.

Normally, EnSight will perform the integration using all of the components of the vector. However, it is possible to restrict the integration to a plane by specifying which components of the vector to use. Typical uses of this feature would be to restrict the Particle traces to a clip plane. Surface-restricted Particle traces provide even greater flexibility in restricting a trace to planes or other surfaces.

Line-type Particle traces consist of bar elements. Ribbons consist of 4-noded quad elements and originate with their end-edge parallel to the Z-axis of the global frame. Then, at each integration step, the leading edge is rotated around the current direction of the path by the same amount the vector field has rotated around the path since the previous time step. Ribbons are not available for surface-restricted Particle traces.

Particle Trace Parts are created on the server, so the Representation-type of the parent Parts has no effect. The algorithm that creates Particle traces initially sets up a cross-referencing map of adjoining elements. Hence, the first Particle trace takes longer to generate than subsequent traces.

If you calculate pathlines, consider calculating as many as possible at a time, since the process can be very time consuming (most of the time is taken in reading time step information). However, the data for the Trace Part is sent to and stored on the Client, Thus, you cannot label or make queries about Particle Trace Parts. Instead, label or make queries about the Particle Trace's parent Part(s). Line-type Particle Traces can be parent Parts for Profiles. You can animate the motion of the massless Particles along their Particle traces.

*Transient Data*

By default the emission point is always set to emit the Particles at the current time step. This can be a problem if you have a transient dataset with the current time set at the last time step available. If you compute pathlines from this location, the default emission time will be at the current time (last time step), thus no pathlines will be generated. To solve this problem you will need to either change the current time, or change the Start Time of the emitter.

The process of creating a Particle trace is always to specify an emission point (location and time), specify the Part(s) to trace the Particle through and specify which vector variable to integrate. There are quick ways of doing this process which assume that the correct defaults are set, or there are more deliberate ways which give you more control. Particle trace Parts carry only one set of attributes for all of the traces in the Part, thus it is not possible, for example, to trace some of the emission points forward in time and others backward in time.

Particle trace Parts are different from all other created Parts in that when the parent Parts change (such as at a time step change), the Particle trace Part does not change. This is due to the fact that the Particle trace has been created at a specified time (the emission time), making the Part independent of time (after the trace has been created).

Regular Particle traces can only be computed through a set of parent Parts consisting of model Parts. Surface-restricted Particle traces can be created on model Parts, clip Parts, elevated surface Parts, and developed surface Parts.

If your dataset contains 3D elements, the Particles for regular traces will be traced through 3D element fields only. Surface-restricted traces would have to be used to trace along 2D elements of such a data set.

**Massed-Particle Traces** A particle trace can be created or updated from a massless-particle trace to a massed-particle trace, or visa-versa. Massed-particle traces are specified via their appended section in the Feature Detailed Editor (Traces) dialog. Massed-particle traces switch to massless-particle traces during interactive mode.

### Definitions

Motion of a particle as a function of its velocity is defined as

$$d/dt (X_p) = V_p$$

with initial conditions  $V_p(t_0) = V_{p,0}$  and initial particle position  $X_p(t_0) = X_{p,0}$  (capital letters denote vectors unless otherwise indicated).

For massless particles, the particle velocity is always identical to the local fluid velocity,  $V_p = V_f$ . For massed particles, additional forces acting on them result in a different velocity for the  $V_p$  than for the fluid,  $V_p$  not equal to  $V_f$ . This particle velocity is determined from a momentum balance for the particle by

$$m_p A_p = F_p,$$

or

$$m_p d/dt (V_p) = F_g + F_p + F_d + F_e,$$

where

$A_p$  = particle acceleration vector,

$F_p$  = total (particle) force vector,

$F_g$  = gravitational (body) force vector =  $m_p b G$ ,

$F_p$  = pressure (surface) force vector =  $- v_p \nabla p_f$ ,

$F_d$  = drag (surface) force(s) vector =  $\frac{1}{2} \rho_f a_p c_d |V_r| V_r$ ,

$F_e$  = additional forces vector, here = 0,

given the following definitions (Note: the underlined definitions are user specified)

$$\begin{aligned}
 m_p &= \text{particle mass} = \rho_p v_p, \\
 \rho_p &= \text{particle density}, \\
 v_p &= \text{particle volume} = d_p^3 \pi/6, \\
 d_p &= \text{particle diameter}, \\
 b &= \text{particle buoyancy ratio} = (\rho_p - \rho_f) / \rho_p, \\
 \rho_f &= \text{fluid density (scalar or constant)}, \\
 G &= \text{gravitational acceleration vector}, \\
 \nabla p_f &= \text{fluid pressure gradient vector, (computed from } p_f = \text{fluid pressure scalar variable)} \\
 a_p &= \text{particle reference area} = d_p^2 \pi/4, \\
 V_r &= \text{reference velocity vector} = V_f - V_p, \\
 c_d &= \text{drag coefficient, typically given as a function of the local relative Re, i.e. } c_d = \underline{c_d(Re)}, \\
 Re &= \text{Reynolds number} = \rho_f |V_r| d_p / \mu_f, \\
 \mu_f &= \text{fluid dynamic viscosity (scalar or constant)}.
 \end{aligned}$$

Thus, the total mass balance equation for massed particles may be defined by:

$$m_p \, d/dt (V_p) = (m_p \, b \, G) - (v_p \, \nabla p_f) + (\frac{1}{2} \rho_f \, a_p \, c_d \, |V_r| \, V_r) \cdot$$

### Drag Coefficient

Currently, the following Drag Coefficient ( $C_d$ ) table is provided as the default.

$Re \ll 1$	$C_d = 24/Re$
$1 < Re \ll 500$	$C_d = 24/Re^{0.646}$
$500 < Re \ll 3e5$	$C_d = 0.43$
$3e5 < Re \ll 2e6$	$C_d = 3.66E-4 \, Re^{.4275}$
$2e6 < Re$	$C_d = 0.18$

This table is also coded as an example for your reference and access via the User-Defined Math Function `DragCoefTable1(Re)` which is found in

`$CEI_HOME/ensight80/src/math_functions/drag_coef_table1/libudmf-drag_coef_table1.c`

In addition, two other drag coefficient functions are provided for your selection via the User-Defined Math Function facility.

$$\text{DragCoefPoly}(Re) = (a + b \, Re + c \, Re^2 + d/Re)$$

Where: {a,b,c,d} are polynomial coefficients with default values of {1.,0.,0.,0}, respectively.

$$\text{DragCoefPower}(Re) = (1 + .15 \, Re^{0.687}) \, 24 / Re$$



Both of these functions are located respectively in

`$CEI_HOME/ensight80/src/math_functions/drag_coef_poly/libudmf-drag_coef_poly.cf`

`$CEI_HOME/ensight80/src/math_functions/drag_coef_power/libudmf-drag_coef_power.c`

You may also code your own. (See UDMF in EnSight User Manual.)

### Particle-Mass Scalar on Boundaries

Information to compute a particle-mass scalar on boundaries ( $m_p = \sum m_{p_i}$ ) is provided each time massed-particle traces are created. This scalar is found and computed via the New Computed Variables (NCV) functionality.

Massed Particle Scalar(massed-particle traced part(s))

This scalar creates a massed-particle per element scalar variable for each of the parent parts of the massed-particle traces. This per element variable is the mass of the particle times the sum of the number of times each element is exited by a mass-particle trace.

### References

The following references have contributed in part toward the development of the massed-particle algorithm.

Donley, H. Edward

“The Drag Force on a Sphere”,

<http://www.ma.iup.edu/projects/CalcDEMma/drag/drag.html>

Lund, Christoph

“Vorgaben für die Berechnung und Visualisierung der Bahnlinien massebehafteter Partikel im Postprozessor EnSight”, Volkswagen AG, 27.07.2001. English translation by Kent Misegades.

Fluid Dynamics International, Inc.

FIDAP 7.0 Theory Manual”, April 1993, pp12-3+

Clicking once on the Particle Trace Create/Update Icon opens the Particle Trace Editor in the Quick Interaction Area which is used to both create and update (make changes to) Particle trace Parts.



Figure 7-71  
Particle Trace Create/Update Icon

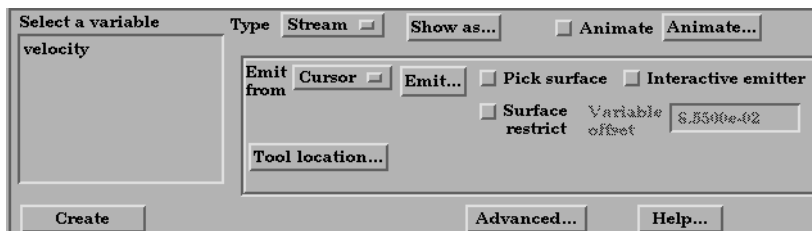

Figure 7-72  
Quick Interaction Area - Particle Trace Editor

Record Button  
(Enabled with active  
trace animation)

<i>Type</i>	Opens a pull-down menu for specification of whether Particle trace calculation uses steady-state data (streamlines) or transient data (pathlines).
Stream	Traces a massless Particle in a steady-state vector field (for steady-state data or the current time-step of transient data).
Path	Traces a massless Particle through a time-varying vector field <i>and so is only available with transient results data</i> . On certain systems, this selection can consume significant quantities of CPU time to calculate the resulting Particle trace.
<i>Show As</i>	Opens a dialog for specification of trace representation.
Line	Depicts the trace as a line.
Ribbon	Depicts trace as if it were a ribbon. The ribbon width is a specified fixed value, while the twisting is determined by the rotation of the flow about the path of the trace at any particular point on the trace.
Square Tubes	Depicts trace as if it were a square tube. The tube width is a specified fixed value, while the twisting is determined by the rotation of the flow about the path of the trace at any particular point on the trace.
<i>Animate Toggle</i>	<p>Toggles on/off the animation of the motion of the Particles along the traces. In addition to creating Particle traces based on vector variables, EnSight can also animate the motion of the Particles along the Particle traces. To distinguish them from discrete Particles, we call Particles moving along Particle traces “tracers.”</p> <p>At any instant, each tracer consists of a portion of a Particle trace displayed with attributes you specify separately from the attributes of the Particle trace. EnSight animates each tracer by updating which portion of the Particle trace is currently displayed. You specify the length of each tracer as a time value, so the tracer’s length varies dynamically as it moves down the Particle trace (faster moving tracers are longer). This option can add tremendously to the understanding of the flow field since relative speed can be determined.</p> <p>EnSight provides control over how the tracer looks and acts. You can animate one, some, or all of the Particle traces you have created, but they are all animated in the one way you specify. To help you get started, at the click of a button EnSight will suggest time-specification values based on the Particle traces you have selected to animate. You can specify the line width of the tracer, and choose to color it with a constant color or the same calculated color used to color the Particle trace. If you wish to change the opacity of the trace in the Color, Lighting and Transparency dialog, you cannot do it with the opacity slider, but must instead use the “screen door” transparency in the Fill Pattern pulldown. You can also display a spherical “head” on the leading-end of the tracer, and dynamically size the head according to any active variable.</p> <p>You control the speed of the motion and have the option to display multiple tracers on the same Particle trace separated by a time interval. Hence, you can choose to view rapid-fire pulses, slow moving “noodles,” or something in between. For steady-state Particle traces (streamlines), “time” is the integration time with the emitters located at time zero. For transient Particle traces (pathlines), you have the option to synchronize the animation time to the solution time. The choice of whether a Particle trace is a streamline or a pathline is made when you create the Particle trace.</p> <p>You do not have to animate the entire Particle trace. You can specify where you want the animation to start with a time value corresponding to a distance down the Particle trace from the emitter, and where you want the animation to stop with a time value corresponding to a distance farther down the Particle trace.</p> <p>Tracers on all animated Particle traces are synchronized. If you combine Particle trace animation with flipbook animation or keyframe animation, the animation time values are automatically synchronized if you toggle-on Sync To Transient in the Trace Animation</p>

Settings dialog.

*Animate...*

Opens the Trace Animation Settings dialog

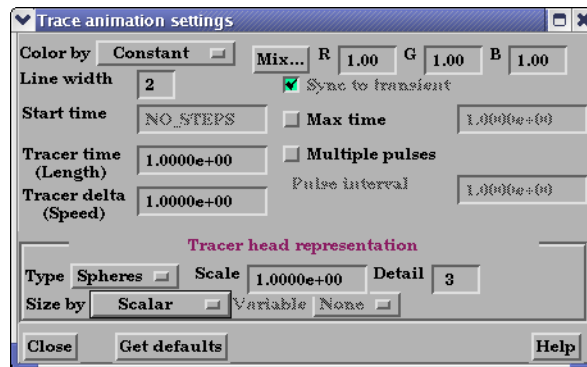

Figure 7-73

Trace Animation Settings dialog

- Color By** Opens a pull-down menu for selection of method by which to color the tracers.
- Constant Displays tracers in the constant color specified in this dialog.
  - Mix... Opens the Color Selector dialog (see Section 8.1, Color Selector).
  - R,G,B Fields allow specification of constant color.
- Trace Color** Displays tracers in the same color as the Particle Trace Part from which they originate.
- Line Width** Specification of displayed width (in pixels) of tracers. Note: Line Width specification may not be available on some workstation platforms.
- Start Time** Specification of how far down each Particle trace to begin displaying tracers. A Particle trace is made up of line segments. Each segment that makes up a Particle trace has an associated time value. The start time indicates where on the Particle trace the tracers will begin animation.
- Tracer Time (Length)** Specification of length of tracers which varies as the tracer speed varies along the Particle trace. The Particle Time Length parameter scales the length of all tracers at all times.
- Tracer Delta (Speed)** Specification of how fast tracers move. Longer times result in faster moving tracers. This parameter is not applicable when using Sync To Transient and displaying transient data through flipbook or keyframe animation.
- Sync to Transient Toggle** Toggles on/off synchronization of tracer position to solution time of transient data. When toggled-on and transient data is in use, each tracer is displayed with its leading-end at the correct location along the Particle trace for the current solution time. Tracers only move forward in time so cycling through transient data is not applicable here.
- Max Time Toggle** Toggles on/off maximum lifetime for all tracers. If toggled-off, tracers continue to end of Particle trace. If toggled-on, each tracer stops after moving down the Particle trace for a distance corresponding to the specified Max Time (or until one of the other conditions that stop a tracer occurs).
- Max Time** Field specifies lifetime of all tracers when Set Max Time is toggled-on.
- Multiple Pulses Toggle** Toggles on/off multiple emission of tracers. When toggled-off, a single tracer for each Particle trace appears at the specified Start Time. When toggled-on, additional tracers appear after each specified Pulse Interval. Not applicable to pathlines.
- Pulse Interval** Field specifies time delay between tracers. Not applicable when Multiple Pulses is toggled-off.
- Tracer Head Representation**
- Type Opens a pull-down menu for selection of type of head for each tracer.

None	Specifies that no head will appear.
Spheres	Specifies that a sphere will appear on the leading end of the tracer.
Scale	Specification of scaling factor for head size. Values between 0 and 1 reduce the size, factors greater than one enlarge the size. Not applicable when Head Type is None.
Detail	Specification of detail-level of head in range from 2 to 10, with 10 being the most detailed (e.g., rounder spheres because more polygons are used to create spheres). Higher values take longer to draw, slowing performance. Not applicable when Head Type is None.
Size By	Opens a pull-down menu for the selection of variable-type to use to size each tracer's head. If you select a variable, the head size is determined by multiplying the Scale factor times the variable value, which will vary depending on the location of the tracer. Not applicable when Head Type is None.
Constant	Sizes head using just the Scale factor value.
Scalar	Sizes head using a scalar variable.
Vector Mag	Sizes head using magnitude a vector variable.
Vector X	Sizes head using X-component of a vector variable.
Vector Y	Sizes head using Y-component of a vector variable.
Vector Z	Sizes head using Z-component of a vector variable.
Variable	Selection of variable to use to size the tracer heads. Not applicable when Type is None or Size By is Constant.
Get Defaults	Click to set time-value specifications in this dialog to values suggested by EnSight based upon the characteristics of the selected Particle traces.

See Also: [How To Animate Particle Traces](#)

### *Troubleshooting Animated Particle Traces*

Problem	Probable Causes	Solutions
No motion. Can't see any tracers.	No Particle traces selected to animate.	Select the traces you wish to animate in the list at the top of the Animated Trace Setup dialog.
	Tracers colored same as Particle traces and have same line width.	Change Color By or Line Width.
	Animate Traces not toggled-on.	Toggle Animate on in the Quick Interaction Area.
	Start Time > maximum Particle trace time for all traces selected.	Change settings in the Trace Animation Settings dialog.
	Delta Time (Speed) set too high.	Change settings in the Trace Animation Settings dialog.
	Particle Time (Length) set too small.	Change settings in the Trace Animation Settings dialog.
Motion too fast.	Delta Time (Speed) set too high.	Change settings in the Trace Animation Settings dialog.
Can't get multiple pulses at same time.	Pulse interval too high.	Decrease to have pulses start closer together.

Problem	Probable Causes	Solutions
Have one big tracer, no pulses.	Pulse interval too small, pulses start right after each other with no separation.	Increase the interval.

*Quick Interaction Area Particle Trace Editor, continued,*

<i>Emit From</i>	Opens a pull-down menu for the specification of the emitter type.
Cursor	Creates Particle trace beginning from the position of the Cursor tool.
Line	Creates Particle traces beginning from the position of the Line tool.
# Points	This field specifies the number of evenly spaced traces you want to emit from the Line tool.
Plane	Create Particle traces beginning from the position of the Plane tool.
# Points	These fields specify the number of traces you want to emit from the Plane tool in the X and Y axes of the tool.
Part	Creates particle traces beginning from nodes of the Part specified by the Part ID Number field.
Part ID	This field specifies the Part you wish to use as an emitter for the creation of a particle trace. The Part ID number for a Part is found in the Main Parts List.
Number of Emitters	This field specifies the number of emitters desired. They will be randomly selected from the nodes of the part. (see <a href="#">Section 3.1, Part Overview</a> )
File	Creates particle traces from the locations specified in an external file. (see <a href="#">Section 11.12, EnSight Particle Emitter File Format</a> )
<i>Emit...</i>	Opens the Emission Detail Attributes dialog.

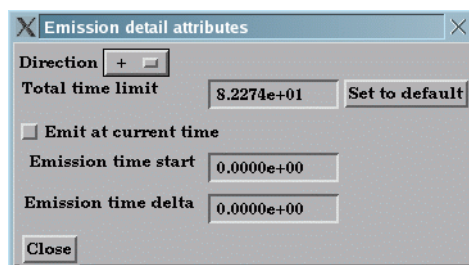

Figure 7-74  
Emission Detail Attributes dialog

Direction	Trace the Particle in positive time, meaning to trace with the vector field, or trace the Particle in negative time, meaning to trace the Particle upstream. Option only applies to streamlines. Pathlines must be traced in + time.
(+)	Positive time option traces Particle(s) forward in time. (This is the only option for pathlines.)
(-)	Negative time option traces Particle(s) backward in time.
(+/-)	Positive/Negative time option traces Particle(s) both forward and backward in time.
Total Time Limit	This field specifies the maximum length of time the Particle trace may continue (it may terminate sooner for other reasons). For vector fields with recirculation zones, this can be important to keep from integrating a trace indefinitely.
Set to default	This button sets the Total Time Limit field to a reasonable default value using the vector value and the geometry size.
Emission Time Start	This field specifies the simulation time at which to begin Particle emission. Enter value

## 7.11 Particle Trace Create/Update

	between beginning and ending time available.
<b>Time Delta</b>	This field specifies the time interval between emissions of Particles from the emitters. If “0”, only one set of emissions will occur at start time
<b>Pick Surface Toggle</b>	Toggles on/off the feature which allows you to place the trace emitter at a point on a surface directly below the mouse pointer by clicking the left mouse button.
<b>Surface-Restrict Toggle</b>	Toggles on/off surface restricted feature for streamlines. The streamline will be constrained to stay on the surface of the selected Part(s) by using only the tangential component of velocity. Be sure to use the Pick Surface feature in locating the emitter for a surface restricted particle trace to ensure that the emitter is located on the surface of a Part.
<b>Variable Offset</b>	If Surface-Restrict toggled on, this field specifies the distance into the flow field at which velocity (and other variables) are to be sampled for the surface restricted trace(s). If velocity values are present at the surface, this offset can be set to zero.
<b>Interactive Emitter</b>	Toggles on/off interactive Particle tracing. Manipulation of the Cursor, Line or Plane tool will cause the Particle trace to be recreated at the new location and updated in the Graphics Window. When manipulation of the tool stops, the Particle trace and any Parts that are dependent on it will be updated. (Only available for non-surface-restricted streamlines).
<b>Tool Location...</b>	Opens Transformations Editor dialog which allows you to precisely position the Cursor, Line or Plane tool.
<b>Create</b>	Creates a Particle trace Part using the selected Part(s) in the Main Parts List and the vector Variable selected in the Main Variables List.
<b>Advanced</b>	Will open the Feature Detail Editor and select the Particle Trace icon for more advance control of the Particle Trace Part.
<b>Record Button</b>	Opens a dialog for recording trace animation to a file. This button is only enabled when an active trace animation is playing.

Feature Detail Editor  
(Traces)

Double clicking on the Particle Trace Create/Update Icon opens the Feature Detail Editor for Particle Traces, the Creation Attributes Section of which provides access to additional functions for trace creation and modification:

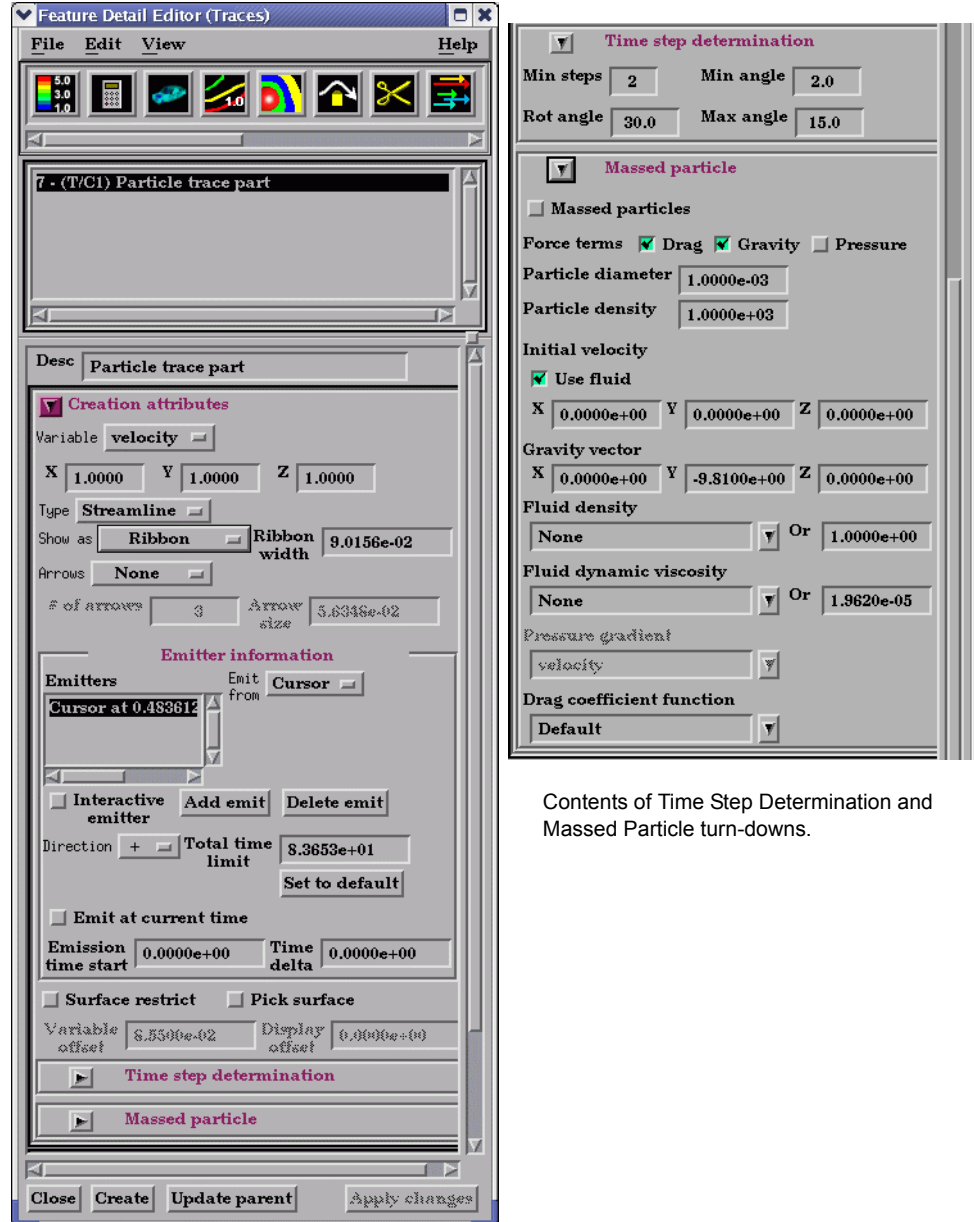

Contents of Time Step Determination and Massed Particle turn-downs.

Figure 7-75  
Feature Detail Editor (Traces)

*Variable*

Opens a pop-up menu for the selection of an active variable to use to calculate the trace.

X Y Z

These fields specify the fraction of each vector component to be used in the calculation. Specify 1 to use the full value of the vector component. Specify 0 to ignore the corresponding vector component (and thus confine the motion of the Particle to a plane perpendicular to that axis). Values between 0 and 1 diminish the contribution of the corresponding component, while values greater than 1 exaggerate them.

*Type*

Opens a pull-down menu for specification of whether Particle trace calculation uses steady-state data to produce a Streamline or transient data to produce a Pathline.

Stream

Traces a massless Particle in a steady-state vector field (for steady-state data or the current time-step of transient data).

## 7.11 Particle Trace Create/Update

Path	Traces a massless Particle through a time-varying vector field <i>and so is only available with transient results data</i> . On certain systems, this selection can consume significant quantities of CPU time to calculate the resulting Particle trace.
Show As	Opens a dialog for specification of trace representation.
Line	Depicts the trace as a line.
Ribbon	Depicts trace as if it were a ribbon. The ribbon width is a specified fixed value, while the twisting is determined by the rotation of the flow about the path of the trace at any particular point on the trace.
Ribbon Width	This field only applies when Ribbon representation is chosen. Larger values in this field produce wider ribbons.
Arrows	Controls whether the flow direction is indicated with arrows. <i>None</i> option displays arrows as lines without tips. <i>Cone</i> arrows have a tip composed of a 3D cone. Good for both 2D and 3D fields. <i>Normal</i> arrows have two short line tips, similar to the way many people draw arrows by hand. The tip will lie in the X-Y, X-Z, or Y-Z plane depending on the relative magnitudes of the X, Y, and Z components of each individual vector. Suggested for 2D problems. <i>Triangles</i> arrows have a tip composed of two intersecting triangles in the two dominant planes. Good for both 2D and 3D fields.
# of Arrows	Controls density of arrows. The trace with the longest dwell time will have this number of arrowheads, and the other traces will get a number that corresponds to their dwell time.
Size	Scaling size of Arrowheads.
<b>Emitter Information</b>	
Emitters List	This section shows a list of all emitters created for the currently selected Particle Trace Part.
Emit From	Opens a pull-down menu for the specification of the emitter type.
Cursor	Creates Particle trace beginning from the position of the Cursor tool.
Line	Creates Particle traces beginning from the position of the Line tool.
# Points	This field specifies the number of traces you want to emit from the Line tool.
Plane	Create Particle traces beginning from the position of the Plane tool.
# Points	These fields specify the number of traces you want to emit from the Plane tool in the X and Y axes of the tool.
Part	Creates particle traces beginning from each node of the Part specified by the Part ID Number field.
Part ID Number	This field specifies the Part you wish to use as an emitter for the creation of a particle trace. The Part ID Number for a Part is found in the Main Parts List. (see <a href="#">Section 3.1, Part Overview</a> )
Density	If 1.0, will emit from each node of the part. Less than 1.0 values indicate a subset of nodes to be used, randomly placed, as emitters.
Interactive Emitter	Toggles on/off interactive Particle tracing. Manipulation of the emitter currently selected in the Emitters List will cause the Particle trace to be recreated at the new location and updated in the Graphics Window. When manipulation of the tool stops, the Particle trace and any Parts that are dependent on it will be updated. (Only available for non-surface-restricted streamlines) (Emitters created by picking a surface or from a Part can not be made interactive).
Add Emit	Adds an emitter of the type specified by Emit From to the currently selected Particle Trace Part.



<i>Delete Emit</i>	Deletes the emitter selected in the Emitters List from the selected Particle Trace Part.
<i>Direction</i>	Trace the Particle in positive time, meaning to trace with the vector field, or trace the Particle in negative time, meaning to trace the Particle upstream. Option only applies to streamlines. Pathlines must be traced in + time.
(+)	Positive time option traces Particle(s) forward in time. (This is the only option for time-dependent datasets.)
(-)	Negative time option traces Particle(s) backward in time.
(+/-)	Positive/Negative time option traces Particle(s) both forward and backward in time.
<i>Total Time Limit</i>	This field specifies the maximum length of time the Particle trace may continue (it may terminate sooner for other reasons).
Set to default	This button sets the Total Time Limit field to a reasonable default value using the vector value and the geometry size.
<i>Emission Time Start</i>	This field specifies the solution time at which to begin Particle emission. Enter value between beginning and ending time available.
<i>Time Delta</i>	This field specifies the time interval between emissions of Particles from the emitters. If “0”, only one set of emissions will occur at start time
<i>Surface-Restrict Toggle</i>	Toggles on/off surface restricted feature for streamlines. The streamline will be constrained to stay on the surface of the selected Part(s) by using only the tangential component of velocity. Be sure to use the Pick Surface feature in locating the emitter for a surface restricted particle trace to ensure that the emitter is located on the surface of a Part.
<i>Pick Surface Toggle</i>	Toggles on/off the feature which allows you to place the trace emitter at a point on a surface directly below the mouse pointer by clicking the left mouse button. This option is forced on if the Surface Restricted Toggle is on.
<i>Variable Offset</i>	This field specifies the distance into the flow field at which velocity (and other variables) are to be sampled for the surface restricted trace(s). If velocity values are present at the surface, this offset can be set to zero.
<i>Display offset</i>	This field specifies the normal distance away from a surface to display the surface restricted traces. A positive value moves the traces away from the surface in the direction of the surface normal.  <i>Please note that there is a hardware offset that will apply to contours, vector arrows, separation/attachment lines, and surface restricted particle traces that can be turned on or off in the View portion of Edit-&gt;Preferences. This preference (“Use graphics hardware to offset line objects...”) is on by default and generally gives good images for everything except move/draw printing. This hardware offset differs from the display offset in that it is in the direction perpendicular to the computer screen monitor (Z-buffer).</i>  Thus, for viewing, you may generally leave the display offset at zero. But for printing, a non-zero value may become necessary so the traces print cleanly.
<i>Time Step Determination</i>	Opens a turn-down area for the specification of time-step parameters.
Min Steps	This field is used to specify the minimum number of integration steps to perform in each element.
Min Angle	If angle between two successive line segments of the Particle trace is less than this value EnSight will double the integration step.
Max Angle	If angle between two successive line segments of the Particle trace is greater than this value EnSight will half the integration step.
Rot Angle	If the dot product between successive rotation vectors of the Particle trace is greater than COS(Rot Angle), the integration step is halved.
<i>Massed Particles</i>	Opens a turn-down area for the specification of massed-particle parameters.

## 7.11 Particle Trace Create/Update

Massed Particles	Toggles on/off the massed-particle traces feature. The default is OFF.
Force Terms	Determines which force terms are used in the momentum balance equation calculation.
Drag Term Toggle	Toggles on/off the inclusion of the drag force term in the massed-particle computation. The default is ON.
Gravity Term Toggle	Toggles on/off the inclusion of the gravity force term in the massed-particle computation. The default is ON.
Pressure Term Toggle	Toggles on/off the inclusion of the pressure force term in the massed-particle computation. The default is OFF.
Particle Diameter	This field specifies the diameter of all particles. The default is 1.e-3.
Particle Density	This field specifies the density value of all particles. The default is 1.e+3.
Initial Velocity	Determines what initial velocity to use for all the particle emitters. The default is Use Fluid Toggle ON.
Use Field Toggle	Toggles on/off whether all particle emitters should use the fluid velocity at their corresponding locations. The default is ON.
X, Y, Z	These fields specify the initial velocity components of all particle emitters. Their default is <0., 0., 0.>.
Gravity Vector	These fields specify the gravity vector to be applied in the massed-particle computation. The default gravity components are <0., -9.81, 0.>. This parameter only works with the gravity force term.
Fluid Density	This field specifies the fluid density variable to be used in the massed-particle computation. The default is "None".
Or	This field specifies the fluid density value to be used in the computation if "None" is specified as the variable name. The default value is 1.
Fluid Dynamic Viscosity	This field specifies the fluid dynamic viscosity variable to be used in the massed-particle computation. The default is "None".
Or	This field specifies the fluid dynamic viscosity value to be used in the computation if "None" is specified as the variable name. The default value is 1.9620e-5. This parameter only works with the drag force term.
Pressure Gradient	This field specifies the fluid pressure gradient variable to be used in the massed-particle computation. The default is "None". This parameter only works with the pressure force term.
Drag Coefficient Function	This field specifies the drag coefficient function to be called each time the drag coefficient is calculated. This function defaults to "None" which essentially defaults to the table described above. Other functions may be accessed via the User-Defined Math Function facility, i.e. DragCoefTable1(Re) (same as default), DragCoefPoly(Re), DragCoefPower(Re). All functions must take the Reynolds Number as their only argument. This parameter only works with the drag force terms.
Create	<p>(At the bottom of the Feature Detail Editor) Creates the Particle trace Part in the Graphics Window as specified.</p> <p>The Feature Detail Editor also allows you to make changes in batch; that is, to make several changes to the menus and fields which do not effect the Graphics Window until you click in the Apply Changes button. It is sometimes quicker (with respect to CPU time) to make several changes at once rather than one at a time as in the Quick Interaction Area.</p> <p>(see <a href="#">Section 3.3, Part Editing</a> for a detailed discussion of the remaining Feature Detail Editor turn-down sections which are the same for all Parts),</p> <p>(see <a href="#">How to Create Particle Traces</a>)</p>

## Troubleshooting Particle Traces

Problem	Probable Causes	Solutions
Particle Trace Part is empty.	Velocity is zero.	Change time steps or change location of emitters.
	Emitter points are outside of flow field.	Change location for emitter points.
	Dataset is 3D and parent Parts are 2D, or dataset is 2D and parent Parts are not planar.	Change parent Parts.
	The created variable selected does not exist for the parent Part(s)	Recreate the variable for the parent Part(s) selected
Streamline is OK, but pathline is empty.	Creating pathline with the emitter emitting at the last time step.	Modify emitter time for the emitter groups.
Particle trace terminates prematurely	Velocity has gone to zero.	None
	Particle has been traced out of the flow field.	None
	Stopping point is at the boundary between two Parts.	Change the parent Parts for the Particle trace to include neighbor Part.
	Particle getting lost and EnSight's search algorithm failing.	Call CEI hotline support.
	Total Time Limit reached.	Change Total Time Limit.
Particle trace exists, then is removed after deleting Parts.	The parent Part for the Particle trace was deleted.	None
Particle trace creation requested, but Particles don't come back.	Requested a large number of Particle traces and/or doing pathlines in large transient dataset.	Be patient.
	Particles are stuck in a recirculation area.	Process will finish when Total Time Limit is reached. Consider terminating job and starting over with a smaller Total Time Limit.
Interactive tracing is slow.	The size of the model and density of the mesh will affect the performance of an interactive trace.	If you can, run on a faster, larger memory workstation. Also, limit if possible the area of interest by cutting the mesh into pieces with the Cut & Split Part editing operation.
Interactive trace does not enter the next Part	Interactive tracing is only done through the Part the emitter resides in.	When you let go of the emitter the full trace will be shown
Surface restricted Particle trace does not appear	Zero velocity at chosen variable offset	Select a Variable offset distance that will give nonzero velocity
	Display offset causing trace to be on opposite side of a surface (hidden surface on)	Change sign of the Display offset
	Emitter does not lie on the surface of selected Parts	Create emitters that lie on the surface
Surface Restricted particle trace does not print well	See Display Offset discussion above	Enter a non-zero display offset.

## 7.12 Subset Parts Create/Update

EnSight enables you to create and modify Subset Parts from ranges of node and/or element labels of model parts. The Subset Parts feature allows you to isolate contiguous and/or non-contiguous regions of large data sets, and apply the full-range of feature applications and inspection provided by EnSight.

Subset Parts can only be created from parts that have node and/or element labels. Therefore, Subset Parts can not be created from any Created Parts, because the only parts that can have node and element labels are Model Parts such as parts built from file data, Merged Model Parts, or Computational Mesh Model Parts (parts created via the periodic computational symmetry Frame attribute). Model Parts that do not have given or assigned node and/or element labels can not be used to create Subset Parts.

Subset Parts are created and reside on the server. They are Created Parts that provide proper updating of all dependent parts and variables.

Subset Parts are created and modified by specifying parent parts, as well as their node and/or element labels. Node and/or element labels can be displayed and filtered interactively according to global View Mode and local Part Mode attributes.

Clicking once on the Subset Parts Create/Update Icon open the Subset Parts Editor in the Quick Interaction Area which is used to both create and update Subset Parts.



Figure 7-76  
Subset Parts Create/Update Icon

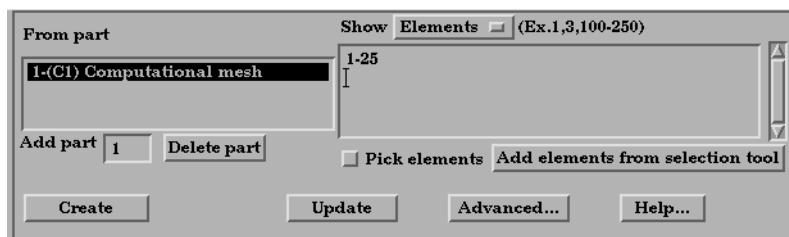

Figure 7-77  
Quick Interaction Area - Subset Parts Editor

### *From Part*

List reflecting the parent parts that have been added to the list. Selecting a part in this list displays any corresponding element or node range specifications in the Show List.

### *Show*

Opens a pull-down menu for selecting which type of part entity you wish to include (or have included) in your Subset Part. The Show options are:

*Elements* show any specified element label ranges

*Nodes* show any specified node label ranges

<i>Show List</i>	This field specifies the label ranges of Elements and/or Nodes wanted for the Subset Part that correspond to the selected part in the From Part list. The Elements or Nodes are specified as a range as the example indicates, i.e. (Ex. 1,3,8,9,100-250).
<i>Add</i>	This field specifies the GUI part number you wish to add to the From Part list.
<i>Delete</i>	This button removes any selected entries in the From Part list along with any corresponding element or node range specifications in the Show List.
<i>Pick elements</i>	This toggle enables element picking from the graphics window. Elements will be picked using the pick selection which by default is the 'p' key.
<i>Add Elements from Selection Tool</i>	Activate the selection tool, and adjust your selection window then click this button to select all the elements within the window.
<i>Update Part</i>	Recreates the Subset Parts selected in the Main Parts List according to the selections in the From Part List and the Show List.
<i>Advanced</i>	<p>Click on the Subset Parts Create/Update Icon to bring up the Feature Detail Editor (Subset Parts), which offers the same features under its the Creation Attributes as offered the Subset Parts as the Quick Interaction Area Editor.</p> <p>(see <a href="#">Section 3.3, Part Editing</a> for a detailed discussion of the remaining Feature Detail Editor turn-down sections which are the same for all Parts),</p>

## 7.13 Profile Create/Update

Profiles visualize values of a variable along a line with a plot projecting away from the line. Projectors are parallel to a plane, but not necessarily in a plane. Hence, Profile can follow the line.

You can scale and offset projectors. The positive direction is set with the center point of the Plane Tool (away from center point is positive). Consider a base-line (not necessarily straight) along which the value of a variable is known. Moving along this base-line, you can “plot” the value of the variable on an “axis” whose origin moves along the base-line and whose orientation varies so that it is always both perpendicular to the base-line and parallel to a specified *plane* (but not necessarily parallel to a *line*, enabling the plot-line to follow the curve of the base-line in one dimension). A surface joining the base-line to the plot-line is called a *profile*.

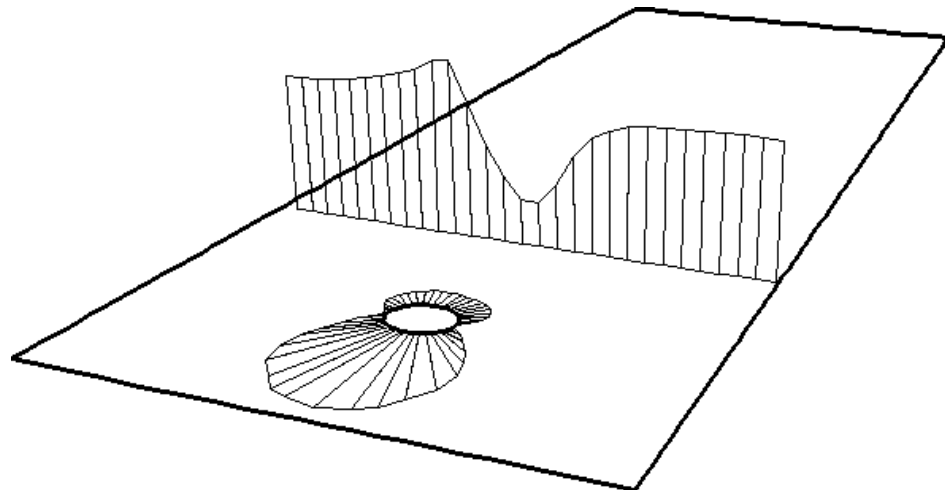

The parent Part of a Profile-Part can be a 2D-Clip Line, a Contour, a Particle Trace, or a model Part consisting of a chain of bar elements. From each node of the parent Part, EnSight draws a “projector” whose length is proportional to the value of the variable at the node, and whose orientation makes it (1) parallel to a specified plane, (2) pointing in a direction corresponding to the sign of the variable’s value at the node (with the negative-direction determined by the location of a specified point), and (3) perpendicular to the base-line elements adjoining the node, or, if the base-line bends at the node, oriented so that its projection into the plane defined by the base-line elements will bisect the angle formed by the base-line elements. The outer-end of each projector is connected to those of its neighbors, forming a series of four-sided polygons and hence a surface.

The appearance of the profile depends greatly on the position of the specified sign-direction point (From Point) and the orientation of the specified plane, which you can specify numerically or with the Plane tool. EnSight calculates the projectors using the vector cross-product of the specified-plane’s normal (the Z-axis) and each parent Part element, thus you should orient the plane so that its normal is not parallel to the parent Part elements.

The projector length is calculated by adding to the variable's value an Offset value, then multiplying the sum by a Scaling value. Adding the Offset enables you to shift the zero location of the projectors, which might be useful if you wanted to make all the projectors have the same sign. An offset performs a “shift”, but does not change the “shape” of the resulting profile. The Scaling factor changes the displayed size of the profile, a “stretching” type of action. EnSight will provide default values for both factors based on the variable's values at the parent Part's nodes.

Clicking once on the Profile Create/Update Icon opens the Profile Editor the Quick Interaction Area which is used to both create and update (make changes to) profile Parts.



Figure 7-78  
Profile Create/Update Icon

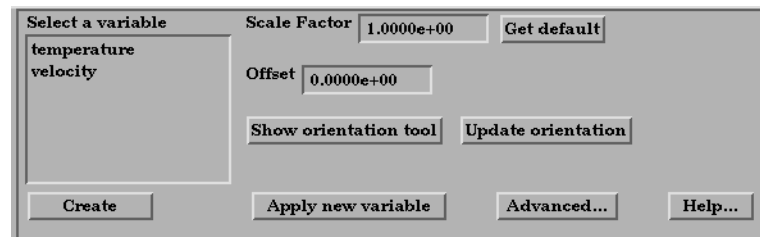

Figure 7-79  
Quick Interaction Area - Profile Editor

- |                              |   |
|------------------------------|---|
| <i>Scale Factor</i>          | This field specifies the scaling for magnitude of the projector. The Scale Factor is multiplied times the value of the variable. Values larger than one increase the size and values smaller than one decrease the size.  |
| <i>Offset</i>                | The value specified in this field is added to the variable values before the Scale Factor is applied to change the magnitude of projectors. Default offset is magnitude of most-negative projector (making them all positive). Has the effect of shifting the plot, but does not change the plot shape. |
| <i>Get Default</i>           | Click to set Scale Factor and Offset values to the calculated defaults based on the variable values for the parent Part.  |
| <i>Show Orientation Tool</i> | Causes the Plane Tool to become visible in the Graphics Window at the location specified  |
| <i>Update Orientation</i>    | Recreates the Profile Part at the current location and orientation of the Plane Tool.   |
| <i>Apply New Variable</i>    | Changes the variable the Profile Part is based on to that currently selected in the Variables List.   |
| <i>Advanced</i>              | Will open the Feature Detail Editor and select the Profile icon for more advance control of the Profile Part.   |

Feature Detail Editor  
(Profiles)

Double clicking on the Profile Create/Update Icon opens the Feature Detail Editor for Profiles, the Creation Attributes Section of which provides access to additional functions for the creation and modification of Profiles:

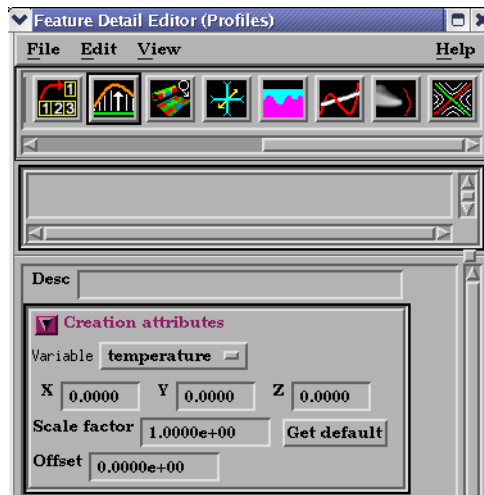

Figure 7-80  
Feature Detail Editor (Profiles)

## X Y Z

These fields specify the vector components used in creating the Part for vector based or coordinate-based Profiles. These fields are not applicable to Scalar-based Profiles. When all fields are zero, the magnitude of the Variable value is used. If a value other than zero is entered into a field, the sum of  $(\text{Vector}_X * X) + (\text{Vector}_Y * Y) + (\text{Vector}_Z * Z)$  is used as the variable value.

## Orientation Plane

Pos of C1  
Pos of C2  
Pos of C3

Specification of the location, orientation, and size of the Plane Clip using the coordinates (in the Parts reference frame) of three corner points, as follows:

- Corner 1 is corner located in negative-X negative-Y quadrant
- Corner 2 is corner located in positive-X negative-Y quadrant
- Corner 3 is corner located in positive-X positive-Y quadrant

## Set Tool Coords

Will reposition the Plane Tool to the position specified in C1, C2, and C3.

## Get Tool Coords

Will update the C1, C2, and C3 fields to reflect the current position of the Plane Tool.

The Feature Detail Editor also allows you to make changes in batch; that is, to make several changes to the menus and fields which do not effect the Graphics Window until you click in the Apply Changes button. It is sometimes quicker (with respect to CPU time) to make several changes at once rather than one at a time as in the Quick Interaction Area.

(see [Section 3.3, Part Editing](#) for a detailed discussion of the remaining Feature Detail Editor turn-down sections which are the same for all Parts),

(see [How To Create Profile Plots](#))



## Troubleshooting Profiles

Problem	Probable Causes	Solutions
The entire profile is not projected the direction you want.	The Plane is not oriented correctly.	Turn on the Plane tool so you can see its orientation. The projectors will be parallel to this plane, so adjust its orientation.
	The From Point is not in a good location	Turn on the Plane tool so you can see the location of the center of the plane. Positive projectors will go away from this point, negative towards.
Portions of the profile appear to be projected in the wrong direction.	The From Point is not in a good location.	Turn on the Plane tool so you can see the location of the center of the plane. Positive projectors will go away from this point, negative towards.
	The normal to the Plane is parallel to some of the elements of the parent Part.	Turn on the Plane tool so you can see its orientation. Try to make sure the Z axis of the Plane tool does not lie parallel to any portions of the parent Part.
	The Parent Part does not contain elements which are consistently ordered	None

## 7.14 Elevated Surface Create/Update

Elevated Surfaces visualize the value of a variable by creating a surface projected away from the 2D elements of the parent Part. It is easiest to describe this feature if you think of a planar Part as the parent Part. Now warp this surface up out of plane proportionally to the value of a variable. The resultant surface is an Elevated Surface. Elevated surfaces are to surfaces what Profiles are to lines. While planar surfaces are perhaps the most useful parent Parts to use, parents do not have to be planar. Model Parts containing 2D elements, Clip Planes, Isosurfaces, and even other elevated surfaces are all valid parent Parts.

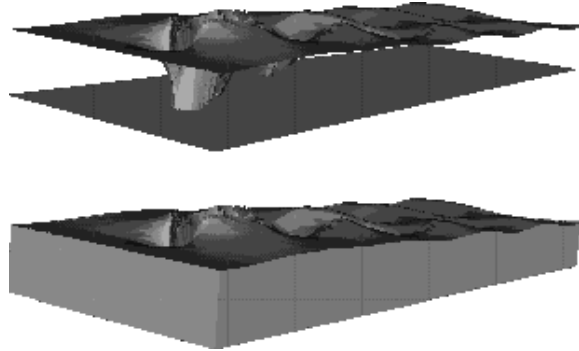

Figure 7-81  
Elevated Surface example, with and without Sidewalls

The parent Part is not actually changed, a new surface is created. As this new surface is “raised”, projection (Sidewall) elements can be created stretching from the parent to the elevated surface around the boundary of the surfaces if desired. Just the surface, just the sidewalls, or both can be created.

The projection from a node on the parent Part will be in the direction of the normal at the node. If the node is shared by multiple elements, the average normal is used.

The projected distance from a parent Part’s node to the corresponding elevated surface node is calculated by adding to the variable’s value an Offset value, then multiplying the sum by a Scaling value. Adding the Offset enables you to shift the zero location of the plane. An Offset performs a “shift”, but does not change the “shape” of the resulting elevated surface. The Scaling factor changes the distance between parent and elevated surface, a “stretching” effect. EnSight will provide default values for both factors based on the variable’s values at the parent Part’s nodes.

Clicking once on the Elevated Surface Create/Update Icon opens the Elevated Surface Editor in the Quick Interaction Area which is used to both create and update (make changes to) elevated surface Parts.



Figure 7-82  
Elevated Surface Create/Update Icon

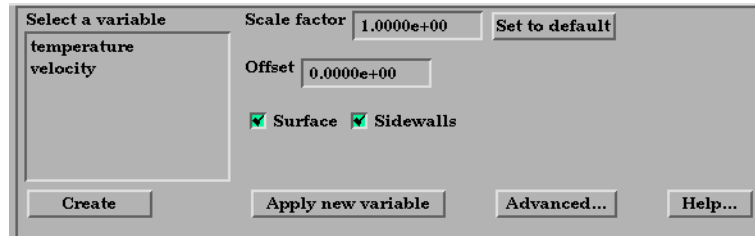

Figure 7-83  
Quick Interaction Area - Elevated Surface Editor

<i>Scale Factor</i>	This field specifies the scaling for magnitude of distance between the parent Part node and the corresponding elevated surface node. The Factor is multiplied times the value of the variable. Values larger than one increase the size and values smaller than one decrease the size. A negative value will have the effect of switching the direction of the projected surface.
<i>Set to Default</i>	Click to set Scale Factor and Offset values to the calculated defaults based on the variable values for the parent Part.
<i>Offset</i>	Value specified is added to the variable values before the Scale Factor is applied to change the magnitude of projected distance. Default offset is magnitude of most-negative projection distance (will cause the surface to be projected positively). Has the effect of shifting the surface plot, but does not change the surface plot shape.
<i>Surface Toggle</i>	Toggles on/off the creation of the actual elevated surface. The sidewalls alone will be created if this toggle is off.
<i>Sidewalls Toggle</i>	Toggles on/off the creation of the sidewalls of the Elevated Surface. Elements will stretch from the parent Part to the Elevated surface around the boundary of the surfaces. The Elevated Surface alone will be created if this toggle is off.
<i>Apply New Variable</i>	Changes the variable the Elevated Surface Part is based on to that currently selected in the Variables List.
<i>Advanced</i>	Will open the Feature Detail Editor and select the Elevated Surface icon for more advance control of the Elevated Surface Part.

Feature Detail Editor (Elevated Surfaces) Double clicking on the Elevated Surfaces Create/Update Icon opens the Feature Detail Editor for Elevated Surfaces, the Creation Attributes Section of which provides access to all of the functions available in the Quick Interaction Area plus one more:

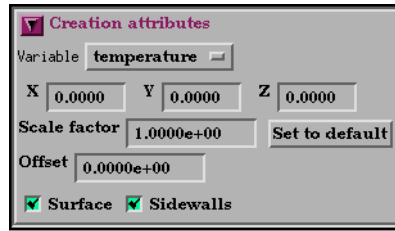

Figure 7-84  
Feature Detail Editor (Elevated Surfaces)

X Y Z

For vector-based or coordinate-based elevated surfaces, specify vector components used in creating the elevated surface. Not applicable to scalar-type elevated surfaces. Are according to the reference frame of the Elevated Surface-Part. Letters labeling dialog data entry fields depend on type of the reference frame (Rectangular, Spherical, or Cylindrical). If all components are 0.0, the vector or coordinate magnitude will be used.

The Feature Detail Editor also allows you to make changes in batch; that is, to make several changes to the menus and fields which do not effect the Graphics Window until you click in the Apply Changes button. It is sometimes quicker (with respect to CPU time) to make several changes at once rather than one at a time as in the Quick Interaction Area.

(see [Section 3.3, Part Editing](#) for a detailed discussion of the remaining Feature Detail Editor turn-down sections which are the same for all Parts),

(see [How to Create Elevated Surfaces](#))

### *Troubleshooting Elevated Surfaces*

Problem	Probable Causes	Solutions
The entire Elevated Surface is not projected in the direction you want.		Change the sign of the scale factor.
You have a non-planar parent Part and the elevated surface seems to have strange intersecting elements.	Sidewall elements are not appropriate	Turn off sidewall toggle.
	Scale factor too large.	Lower the Scale Factor.
The Elevated Surface projection appears to be “confused” at various locations.	Inconsistently ordered elements, such that the normals are not “consistent”	Modify element ordering to be consistent, if possible.

## 7.15 Vortex Core Create/Update

Vortex cores help visualize the centers of swirling flow in a flow field. EnSight creates vortex core segments from the velocity gradient tensor of 3D flow field part(s). Core segments can then be used as emitters for ribbon traces to help visualize the strength and nature of the vortices.

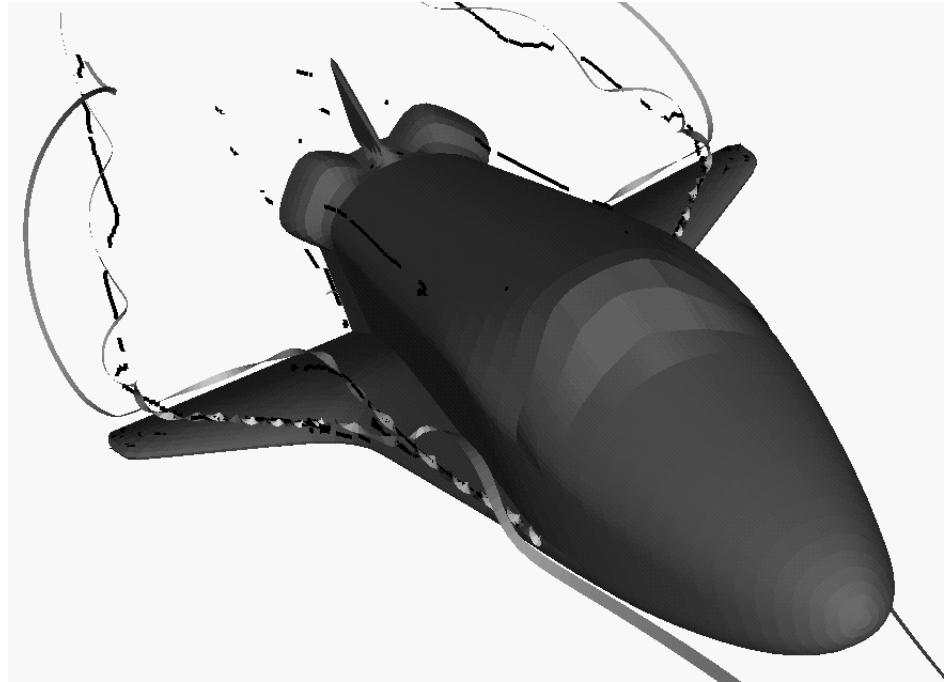

### Velocity Gradient Tensor

EnSight automatically pre-computes the velocity gradient tensor for all 3D model parts prior to creating the vortex cores. Since this variable is automatically created, all subsequent 3D model parts created will also have this tensor computed.

*Note: The velocity gradient tensor variable will continue to be created and updated for all 3D model parts until it is deactivated.*

This tensor variable behaves like any other created tensor variable, and may be deactivated via the Feature Detail Editor (Variables) dialog.

### Thresholding

Core segments may be filtered out according to the settings of a threshold variable, value, and relational operator (see [Access](#) below for details). Most active variables can be used as threshold variables. Thresholding was implemented to help the user filter-out, or view portions of the core segments according to variable values.

When vortex core parts are Created/Updated, the vorticity magnitude scalar variable “fx\_vortcore\_streng” is created to help you threshold unwanted core segments according to these scalar values. (This is the magnitude (RMS) of the vorticity as defined in chapter 4.)

Due to the difference in algorithms, some segments produced may not be vortex cores (see [Caveats](#)). Thus, the need for a filtering mechanism that filters out segments according to different variables arose and has been provided via thresholding options.

**Algorithms**

Currently, vortex cores are calculated according to two algorithms based on techniques outlined by Sujudi, Haimes, and Kenwright (see [References](#) below). Both techniques are linear and nodal. That is, they are based on decomposing finite elements into tetrahedrons and then solving closed-form equations to determine the velocity gradient tensor values at the nodes. Also, any variable with values at element centers are first averaged to element nodes before processing.

The eigen-analysis algorithm uses classification of eigen-values and vectors to determine whether the vortex core intersects any faces of the decomposed tetrahedron. The vorticity based algorithm utilizes the fact of alignment of the vorticity and velocity vectors to determine core intersection points.

**References**

Please refer to the following references for more detailed explanations of pertinent concepts and algorithms.

D. Banks, B. Singer, "Vortex Tubes in Turbulent Flows: Identification, Representation, Reconstruction", IEEE Visualization '94, 1994

D. Sujudi, R. Haimes, "Identification of Swirling Flow in 3-D Vector Fields", AIAA-95-1715, Jun. 1995

D. Kenwright, R. Haimes, "Vortex Identification - Applications in Aerodynamics", IEEE Visualization '97, 1997

M. Roth, R. Peikert, "A Higher-Order Method For Finding Vortex Core Lines", IEEE Visualization '98, 1998

R. Haimes and D. Kenwright, "On the Velocity Gradient Tensor and Fluid Feature Extraction", AIAA-99-3288, Jan. 1999

R. Peikert, M. Roth, "The 'Parallel Vectors' Operator - a vector field visualization primitive", IEEE Visualization '99, 1999

D. Kenwright, T. Sandstrom, GEL, NASA Ames Research Center, 1999

R. Haimes, D. Kenwright, The Fluid Extraction Toll Kit, Massachusetts Institute of Technology, 2000

R. Haimes, K. Jordan, "A Tractable Approach to Understanding the Results from Large-Scale 3D Transient Simulations", AIAA-2000-0918, Jan. 2001

**Caveats**

Due to the linear implementation of both the eigen-analysis and vorticity algorithms, they both have problems finding cores of curved vortices. In addition, testing has shown that both algorithms usually fail to predict vortex core segments in regions of weak vortices.

Since the eigen-analysis method finds patterns of swirling flow, it can also locate swirling flow features that are not vortices (especially in the formation of boundary layers). These non-vortex core type segments can be filtered out via thresholding (see [Thresholding](#)). In addition, the eigen-analysis algorithm may produce incorrect results when the flow is under more than one vortex, and has a tendency to produce core locations displaced from the actual vortex core.

The vorticity based method does not seem to exhibit the problem of producing core segments due to boundary layer formations, because the stress components of the velocity gradient tensor have been removed in the formation of the vorticity vector. Thus, the vorticity method seems to produce longer and more contiguous cores - in most cases; and therefore, the reason for including both algorithms.

## Access

Clicking once on the Vortex Core Create/Update Icon opens the Vortex Core Editor in the Quick Interaction Area which is used to both create and update (make changes to) the vortex core parts.

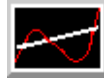

Figure 7-85  
Vortex Core Create/Update Icon

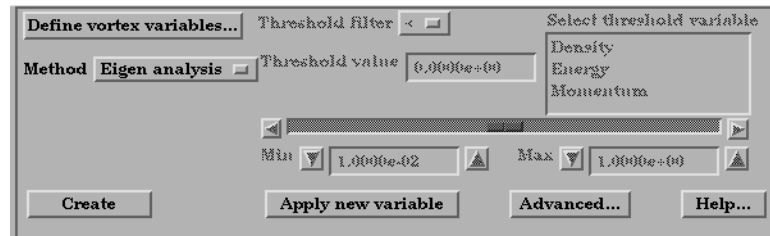

Figure 7-86  
Quick Interaction Area - Vortex Core Editor (before Create)

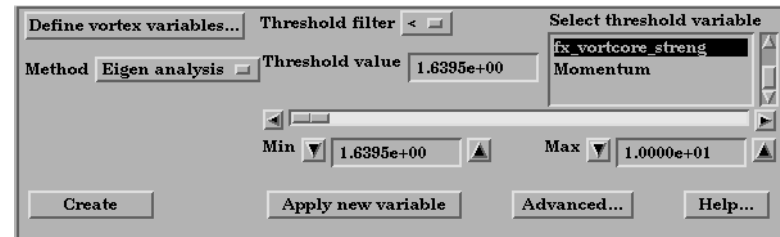
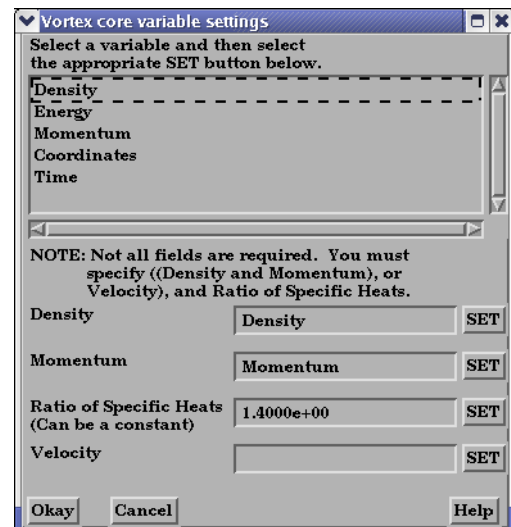

Figure 7-86  
Quick Interaction Area - Vortex Core Editor (after Create)

### Define Vortex Variables

Opens the Vortex Core Variable Settings dialog which allows the user to identify and set the dependent variables used in computing the vortex cores. This dialog has a list of current accessible variables from which to choose. Immediately below is a list of dependent variables with corresponding text field and SET button. The variable name in the list is tied to a dependent variable below by first highlighting a listed variable, and then clicking the corresponding dependent variables's SET button, which inserts the listed variable into its corresponding text field.

All text fields are required, except you may specify either Density and Momentum (which permits velocity to be computed on the fly), or just Velocity. A default constant value is supplied for the Ratio of Specific Heats which may be changed or specified by a scalar variable name.



Clicking Okay activates all specified dependent variables and closes the dialog.

Method	<p>Opens a pop-up dialog for the specification of which type of method to use to compute the vortex cores in the 3D field. These options are:</p> <p><i>Eigen Analysis</i> Scheme that uses eigen-analysis on the Velocity gradient tensor to compute the vortex core segments. (See <a href="#">Algorithms</a> above).</p> <p><i>Vorticity</i> Scheme that uses the vorticity vector from the anti-symmetric portions of the velocity gradient tensor to compute the vortex core segments. (See <a href="#">Algorithms</a> above).</p>
Threshold Filter	<p>Relational operators used to filter out vortex core segments.</p> <p>&lt; Filter out any core segments less than the Threshold Value (default).</p> <p>&gt; Filter out any core segments greater than the Threshold Value.</p>
Threshold Value	The value at which to filter the vortex core segments.
Select Threshold Variable List	A list of possible variables that you may use to help filter out vortex core segments. This list includes the vorticity magnitude scalar variable (named <code>fx_vortcore_streng</code> ) which gets created when you Create/Update a vortex core part.
Threshold Slider Bar	<p>Used to change the Threshold Value in increments dependent on the Min and Max settings. The stepper button on the left (and right) of the slide bar is used to decrement (and increment) the Threshold value.</p> <p><i>Min</i> The minimum value of the Threshold Variable. The stepper button on the left (and right) side of the Min text field is used to decrease (and increase) the order of magnitude, or the exponent, of the min value.</p> <p><i>Max</i> The maximum value of the Threshold Variable. The stepper button on the left (and right) side of the Max text field is used to decrease (and increase) the order of magnitude, or the exponent, of the Max value.</p>
Create	Creates vortex cores that correspond to the selected 3D field in the part list, based on the respective settings.
Apply New Variable	Applies the threshold settings to the vortex core segments based on the threshold variable that is highlighted in the Select Threshold Variable list.
<i>Advanced</i>	Will open the Feature Detail Editor and select the Vortex Core icon for more advance control of the Vortex Core Part.

*Note: Vortex Core feature extraction does not work with multiple cases.*

### Troubleshooting Vortex Cores

Problem	Probable Causes	Solutions
Error creating vortex cores	Non-3D part selected in part list	Highlight 3D part
Undefined (colored by part color) regions on vortex cores	Vortex core line segment node was not mapped within a corresponding 3D field element	Make sure corresponding 3D field part is defined.



## 7.16 Shock Surface/Region Create/Update

The Shock Surface/Region feature helps visualize shock waves in a 3D flow field. Shock waves are characterized by an abrupt increase in density, energy, and pressure gradients, as well as a simultaneous sudden decrease in the velocity gradient.

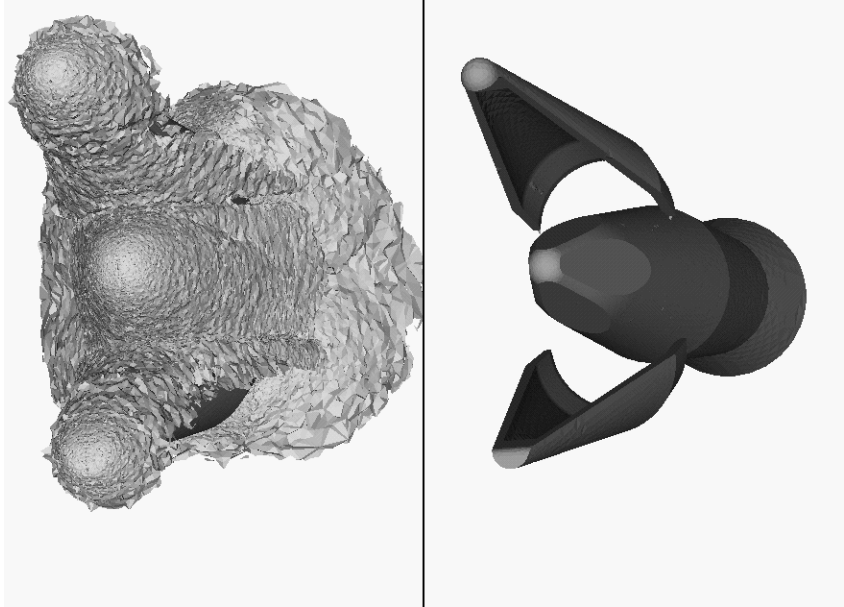

Figure 7-87  
Shock Surface (Data Courtesy of Craft Technology)

EnSight creates candidate shock surfaces in 3D (trans/super-sonic) flow fields using a creation scalar variable (i.e. density, pressure) along with the velocity vector (see [Algorithms](#) below).

### Thresholding

Due to the nature of the shock algorithms, other surfaces with similar characteristics may be produced besides shock surfaces, i.e. expansion regions, etc. Therefore, a filtering mechanism is necessary to help filter out these non-shock regions.

Shock surfaces may be filtered out according to the settings of a threshold variable, value, and relational operator (see [Access](#) below for details). Most active variables can be used as threshold variables, but gradients of the density and energy related scalar variables in the streamwise direction seem to work best.

When Shock parts are created via the Surface method, the scalar “SHK\_\*” variable (where \* is the appended name of the variable, i.e. SHK\_Density) is created to help threshold unwanted areas according to these scalar values. When Shock parts are created via the Region method, the scalar “SHK\_Threshold” variable is created to help threshold respective unwanted areas.

Currently, these SHK\_\* variables consist of the gradient of an appropriate creation variable (i.e. SHK\_Density, SHK\_Pressure, etc.) in the streamwise direction. For the Region method, the creation variable is always pressure.

EnSight tries to compute a reasonable default threshold value each time one of these threshold variables is applied. By default this value is half of one exponential order less than the maximum value of the threshold variable on the

shock part. This seems to produce a reasonable starting surface for the user to threshold. By default, the smaller the threshold value, the larger the part.

The default threshold variable for non “SHK\_” variables is the minimum of the specified variable on the shock part.

The default Min/Max slider values try to bound the default threshold value by appropriate orders of magnitude. Min/Max slider values floor/ceil the min/max values of the threshold variable of the shock part when these ranges are exceeded (see Threshold Slider Bar below).

## Algorithms

Shock parts are calculated according to two algorithms, or methods. The first algorithm (referred to by EnSight as the Surface method) is based on the work of Pagendarm et. al., and the second algorithm (referred to by EnSight as the Region method) is based on the work by Haimes et. al. (See [References](#) below.)

The Surface method utilizes the maximal gradient of a quantity like density or pressure in the streamwise direction. This yields a surface that requires thresholding to distinguish significant portions of the shock patterns from weak numerical artefacts.

The Region method utilizes flow physics to define shocks in steady state and transient solutions. The steady state equation is based on developing a scalar field based on combining the mach vector with the normalized pressure gradient field. The transient solution combines this term with appropriate correction terms. The Region method produces iso-shock surfaces that form regions that bound the shock wave.

Note: Both methods use dependent variables (See Define Shock Variables below). If some of the dependent variables do not exist and are required, they will be temporarily calculated based on other defined dependent variables (as defined in [Section 4.3, Variable Creation](#)). The user has the responsibility to ensure these variables have consistent units.

Both techniques have been implemented in a linear and nodal fashion. That is, their gradient calculations are based on decomposing finite elements into tetrahedrons to approximate the gradient values at the nodes. Also, any variables with values at element centers are averaged to element nodes before processing.

## Other Notes

*Pre-filtering flow field elements by Mach Number.*

The Surface Method allows the user to filter-out any flow field elements less than a specified mach number, by issuing the following command via the command line processor (See [Section 2.5, Command Files](#)):

```
test: shock_mach_prefilter #
```

Where # is the corresponding mach-number value ( $\geq 0.0$ ) by which to filter. (Zero is the default value - which means this option is turned-off until activated by a value  $> 0.0$ .) Ideally this mach-number value would be 1; and thus, would eliminate any subsonic regions from being processed via the Surface method's algorithm. In some transonic cases, this has doubled the efficiency of the algorithm by eliminating the calculation of the second derivative on many elements. Unfortunately, other cases have been observed (especially noticed in regions with normal shock waves) where this option (due to the grid resolution and/or the numerical dissipation inherent in the shock algorithm - see 1999 reference by D. Lovely and R. Haimes) has eliminated some valid shock regions. Although care is taken to provide an appropriate stencil of elements for the

gradient calculations of values adjacent to these areas, it appears this value may need to be  $< 1$  to prevent these shock regions from being eliminated. This option is therefore provided at the discretion and expertise of the user. This option only takes effect when issued prior to a create or an update in shock method.

*Post-filtering shock part elements by Mach Number.*

Both methods allow the user to filter-out (prior to thresholding) any shock part elements less than a specified mach number, by issuing the following command via the command line processor (see [Section 2.5, Command Files](#)):

```
test: shock_mach_postfilter #
```

Where # is the corresponding mach-number value ( $\geq 0.0$ ) by which to filter. (Zero is the default value - which means this option is turned-off until activated by a value  $> 0.0$ .) Ideally this mach number value would be 1; and thus, would eliminate any subsonic regions from being displayed as part of the shock surface. Unfortunately, some cases have been observed (especially noticed in regions with normal shock waves) where this options (due to the grid resolution and/or the numerical dissipation inherent in the shock algorithm - see 1999 reference by D. Lovely and R. Haines) has eliminated some valid shock regions. This option is therefore provided at the discretion and expertise of the user. This option only takes effect when issued prior to a create or an update in shock method.

*Moving Shock.*

Both methods compute the stationary shock based on the user specified parameters. The Region Method has the capability of applying a correction term to represent moving shocks in transient cases. This capability is toggled ON/OFF by issuing the following command via the command line processor (see [Section 2.5, Command Files](#)).

```
test: toggle_moving_shock
```

Issuing the command a second time will toggle this option off. This option is provided at the discretion and expertise of the user. This option only takes effect when issued prior to a create or an update in shock method.

## References

Please refer to the following references for more detailed explanations of pertinent concepts and algorithms.

H.G. Pagendarm, B. Seitz, S.I. Choudhry, "Visualization of Shock Waves in Hypersonic CFD Solutions", DLR, 1996

D. Lovely, R. Haines, "Shock Detection from Computational Fluid Dynamics Results", AIAA-99-3285, 1999, 14th AIAA Computational Fluid Dynamics Conference, Vol 1 technical papers.

R. Haines and D. Kenwright, "On the Velocity Gradient Tensor and Fluid Feature Extraction", AIAA-99-3288, Jan. 1999, 14th AIAA Computational Fluid Dynamics Conference, Vol 1 technical papers.

D. Kenwright, T. Sandstrom, GEL, NASA Ames Research Center, 1999

R. Haines, D. Kenwright, The Fluid Extraction Tool Kit, Massachusetts Institute of Technology, 2000, 39th Aerospace Sciences Meeting and Exhibit, Reno.

R. Haines, K. Jordan, "A Tractable Approach to Understanding the Results from Large-Scale 3D Transient Simulations", AIAA-2000-0918, Jan. 2001

## Access

Clicking once on the Shock Surface/Region Create/Update Icon opens the Shock Editor in the Quick Interaction Area which is used to both create and update (make changes to) the shock part.

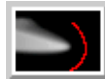
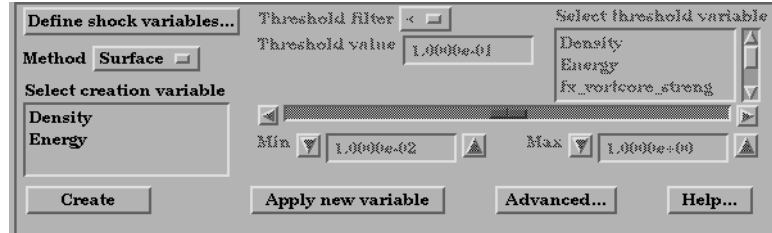

Figure 7-88  
Shock Surfaces/Regions Create/Update Icon



Quick Interaction Area - Shock Surfaces/Regions Editor (before Create)

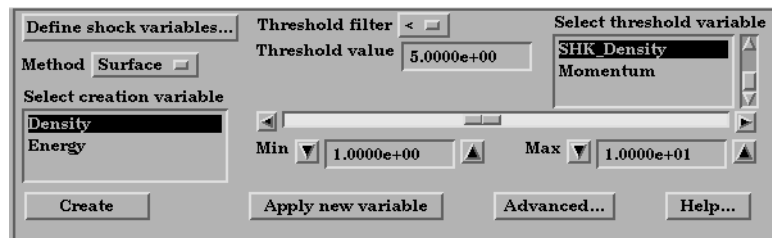
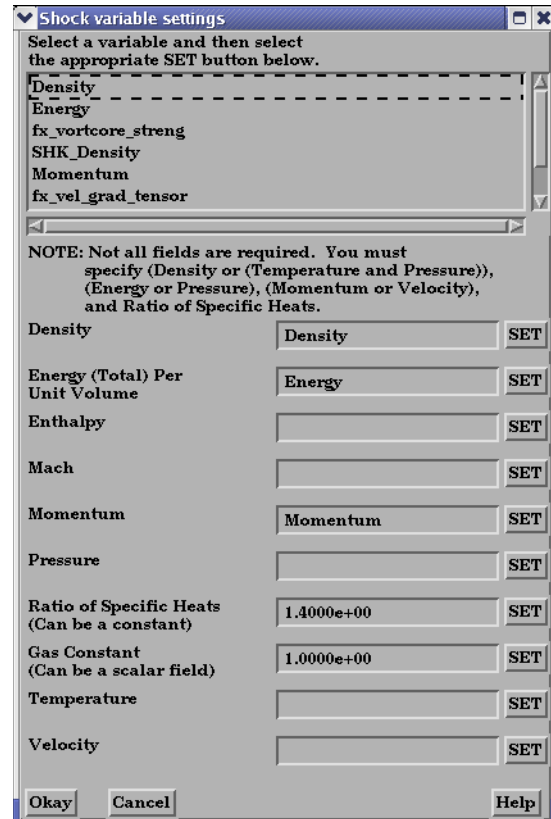

Figure 7-89  
Quick Interaction Area - Shock Surfaces/Regions Editor (after Create)

### Define Shock Variables...

Opens the Shock Variable Settings dialog which allows the user to identify and set the dependent variables used in computing the shock parts. This dialog has a list of current accessible variables from which to choose. Immediately below is a list of dependent variables with corresponding text field and SET button. The variable name in the list is tied to a dependent variable below by first highlighting the listed variable, and then clicking the corresponding dependent variable's SET button, which inserts the listed variable into its corresponding text field.

Not all text fields are required. Although you must specify either Density or Pressure, Temperature, and Gas Constant; either Energy or Pressure; either Velocity or Momentum; and the Ratio of Specific Heats. A default constant value is supplied for the Ratio of Specific Heats and the Gas Constant which may be changed or specified by a scalar variable name.



Clicking Okay activates all specified dependent variables and closes the dialog.

Method	<p>Opens a pop-up dialog for the specification of which type of method, to use to compute the vortex cores in the 3D field. These options are:</p> <p><i>Surface</i> Scheme that uses maximal density or pressure gradients in the streamwise direction to locate candidate shock surfaces. (See <a href="#">Algorithms</a> above).</p> <p><i>Region</i> Scheme that uses flow physics based on the mach vector coupled with pressure gradient to locate candidate shock regions. (See <a href="#">Algorithms</a> above.)</p>
Select Creation Variable	<p>A list of variables used to create the shock surface via Surface method. These variable are specified via those SET in the Define Shock Variables list above.</p> <p><i>Note: This list is not used for the Region method. The Region method only uses pressure as the creation variable.</i></p>
Threshold Filter	<p>Relational operators used to filter out shock areas.</p> <p>&lt; Filter out any areas less than the Threshold Value (default).</p> <p>&gt; Filter out any areas greater than the Threshold Value.</p>
Threshold Value	The value at which to filter the shock areas.
Select Threshold Variable List	A list of possible variables that you may use to help filter out unwanted areas. This list includes the shock threshold variables “SHK_*” which gets created when you Create/ Update a shock part.
Threshold Slider Bar	<p>Used to change the Threshold Value in increments dependent on the Min and Max settings. The stepper button on the left (and right) of the slide bar is used to decrement (and increment) the Threshold value.</p> <p><i>Min</i> The minimum value of the Threshold Variable. The stepper button on the left (and right) side of the Min text field is used to decrease (and increase) the order of magnitude, or the exponent, of the Min value.</p> <p><i>Max</i> The maximum value of the Threshold Variable. The stepper button on the left (and right) side of the Max text field is used to decrease (and increase) the order of magnitude, or the exponent, of the Max value.</p>
Create	Creates shock parts that correspond to the selected 3D field in the part list, based on the respective settings.
Apply New Variable	Applies the threshold settings to shock surfaces based on the threshold variable that is highlighted in the Select Threshold Variable list.
<i>Advanced</i>	Will open the Feature Detail Editor and select the Shock Surface icon for more advance control of the Shock Surface Part.

*Note: Shock Surface feature extraction does not work with multiple parts.*

### Troubleshooting Shock Surfaces/Regions

Problem	Probable Causes	Solutions
Error creating shock part	Non-3D part selected in part list	Highlight 3D flow field part
No shock part created	Flow field part subsonic	No shock in subsonic regions

Problem	Probable Causes	Solutions
	Shock dependent variables defined with incorrect units, i.e. since Region method uses density and mach, if file variables are pressure, temperature, and velocity, then density (and thus mach) is dependent on gas constant. By default this value is 287 (Nm/KgK)	Make sure dependent variables have correct units. i.e. gas constant may need to be 1716(ft-lb/slugDegR), or some other value rather than the default
No to little shock part created	Threshold value too large for < operation	Decrease threshold value

## 7.17 Separation/Attachment Lines Create/Update

Separation and Attachment Lines exist on 2D surfaces and help visualize areas where flow abruptly leaves or returns to the 2D surface in 3D flow fields. These lines are topologically significant curves on the 2D surface where flow converges and then separates (separation lines) from the surface into the 3D flow field, and where flow attaches and then diverges (attachment lines) to the surface from the 3D flow field.

These line segments can be used as emitters for ribbon traces to help visualize flow interaction from the 2D surface into the 3D field, or displayed along with surface-restricted traces to help visualize the topology of the 2D surface.

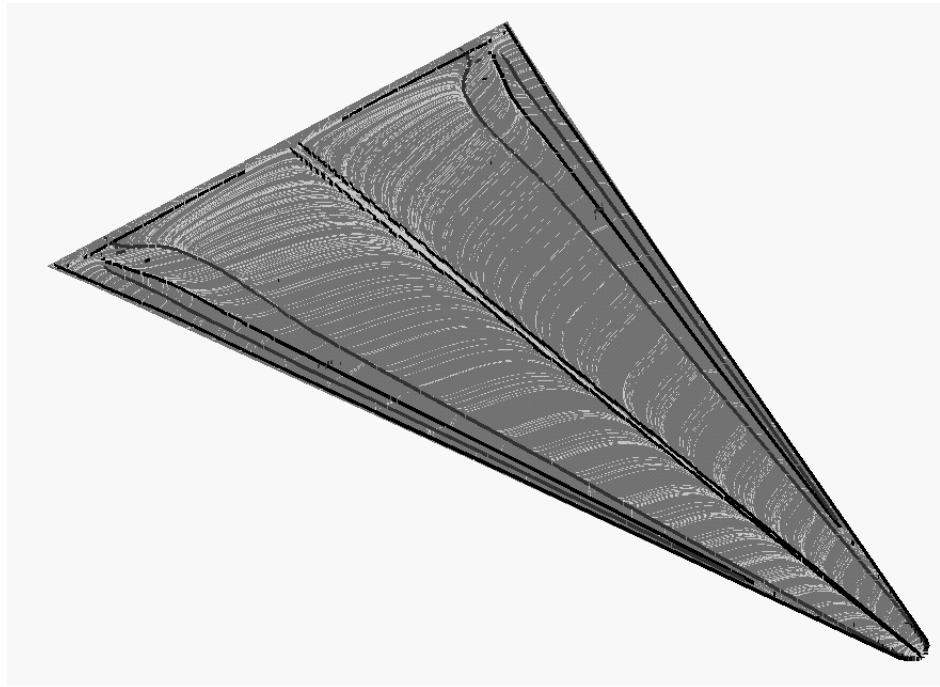

EnSight creates separation and attachment lines as two distinct parts so that each may be assigned their own attributes. Although both are updated computationally when changes are made to either one via the quick interaction area.

Separation/Attachment lines can be created on any 2D part, whether it is a boundary surface or internal surface to a 3D flow field. These lines can also be created on 3D flow field parts. However, computation of the separation/attachment lines is restricted to only the boundary surfaces of the 3D flow field.

### Velocity Gradient Tensor

EnSight creates separation and attachment lines from the velocity gradient tensor of the 3D flow field part. EnSight automatically pre-computes the velocity gradient tensor for all 3D model parts prior to creating the separation and attachment lines. These values are then mapped to any corresponding 2D model part, or inherited by any created part.

Since this variable is automatically created, all subsequent 3D model parts created will also have this tensor variable computed.

*Note: The velocity gradient tensor variable will continue to be created and updated for all 3D model parts until it is deactivated.*

This tensor variable behaves like any other created tensor variable, and may be deactivated via the Feature Detail Editor (Variables) dialog.

### Thresholding

Separation/Attachment lines may be filtered out according to the settings of a threshold variable, value, and relational operator (see [Access](#) below for details). Most active variables can be used as threshold variables. Thresholding was implemented to help the user to filter-out, or view portions of the line segments according to variable values.

When separation and attachment line parts are Created/Updated, the scalar variable “fx\_sep\_att\_strength” is created to help you threshold unwanted core segments according to these scalar values.

*Note: This scalar variable is currently set to the vorticity magnitude scalar, until a better thresholding variable can be identified.*

Since it has been observed that the current implementation of this algorithm may produce additional lines that are not separation or attachment lines, the need for a filtering mechanism that filters out segments according to different variables arose and had been provided via thresholding options.

### Algorithms

Currently, separation and attachment lines are calculated according to the phase-plane algorithm presented by Kenwright (see [References](#) below). This algorithm detects both closed and open separation. Closed separation lines originate and terminate at critical points. Whereas open separation lines do not need to start or end at critical points.

This technique is linear and nodal. That is, 2D elements are decomposed into triangles, and then closed-form equations are solved to determine the velocity gradient tensor values for eigen-analysis at the nodes. Also, any variables with values at element centers are averaged to element nodes before processing.

### References

Please refer to the following references for more detailed explanations of pertinent concepts and algorithms.

J. Helman, L. Hesselink

“Visualizing Vector Field Topology in Fluid Flows”,  
IEEE CG&A, May 1991

D. Kenwright, “Automatic Detection of Open and Closed Separation and Attachment Lines”, IEEE Visualization ‘98, 1998, pp. 151-158

R. Haimes and D. Kenwright, “On the Velocity Gradient Tensor and Fluid Feature Extraction”, AIAA-99-3288, Jan. 1999, pp. 315-324

S. Kenwright, C. Henze, C. Levit, “Feature Extraction of Separations and Attachment Liens”, IEEE TVCG, Apr.-Jun. 1999, pp. 135-144

R. Peikert, M. Roth, “The ‘Parallel Vectors’ Operator - a vector field visualization primitive”, IEEE Visualization ‘99, 1999

D. Kenwright, T. Sandstrom, GEL, NASA Ames Research Center, 1999

R. Haimes, D. Kenwright, The Fluid Extraction Tool Kit,  
Massachusetts Institute of Technology, 2000



## Access

Clicking once on the Separation and Attachment Lines Create/Update Icon opens the Separation and Attachment Lines Editor in the Quick Interaction Area which is used to both create and update (make changes to) the separation and attachment line parts.



Figure 7-90  
Separation/Attachment Lines Create/Update Icon

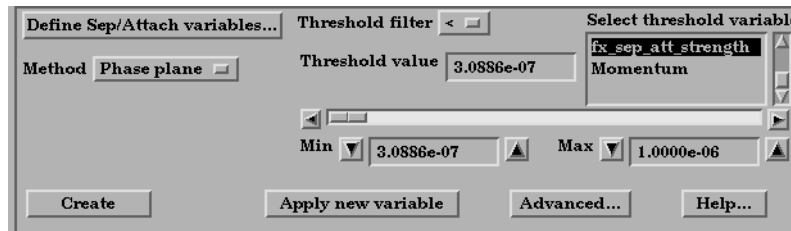
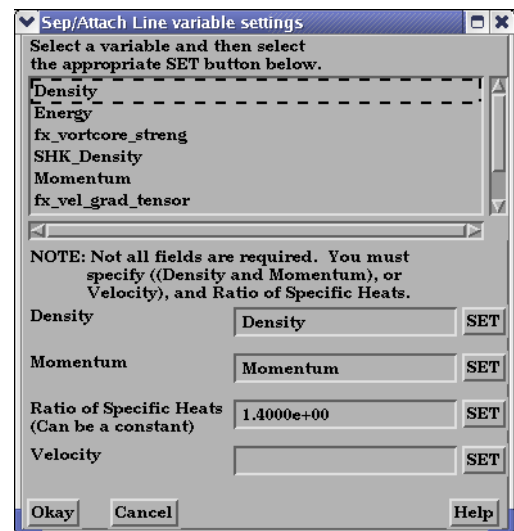

Figure 7-91  
Quick Interaction Area - Separation/Attachment Lines Editor

## Define Sep/Attach Variables...

Opens the Sep/Attach Line Variable Settings dialog which allows the user to identify and set the dependent variables used in computing separation and attachment lines. This dialog has a list of current accessible variables from which to choose. Immediately below is a list of dependent variables with corresponding text field and SET button. The variable name in the list is tied to a dependent variable below by first highlighting a listed variable, and then clicking the corresponding dependent variable's SET button, which inserts the listed variable into its corresponding text field.



All text fields are required, except you may specify either Density and Momentum (which permits velocity to be computed on the fly), or just

Velocity. A default constant value is supplied for the Ratio of Specific Heats which can be changed or specified by a scalar variable name.

Clicking Okay activates all specified dependent variables and closes the dialog.

## Method

Opens a pop-up dialog for the specification of which type of method, to use to compute the separation and attachment lines on the 2D surface. These options are:

*Phase Plane* - Scheme that uses eigen-analysis on the velocity gradient tensor along with phase plane analysis to compute the separation and attachment line segments (see [Algorithms](#)).

## Threshold Filter

Relational operators used to filter out line segments.

- < Filter out any line segments less than the Threshold Value (default).
- > Filter out any line segments greater than the Threshold Value.

## Threshold Value

The value at which to filter the line segments.

## Select Threshold Variable List

A list of possible variables that you may use to help filter out line segments. This list includes the vorticity magnitude scalar variable (named `fx_sep_att_strength`) which gets created when you Create/Update a separation and attachment part.

Threshold Slider Bar	Used to change the Threshold Value in increments dependent on the Min and Max settings. The stepper button on the left (and right) of the slide bar is used to decrement (and increment) the Threshold value.  <i>Min</i> The minimum value of the Threshold Variable. The stepper button on the left (and right) side of the Min text field is used to decrease (and increase) the order of magnitude, or the exponent, of the min value.  <i>Max</i> The maximum value of the Threshold Variable. The stepper button on the left (and right) side of the Max text field is used to decrease (and increase) the order of magnitude, or the exponent, of the Max value.
Create	Creates separation and attachment lines that correspond to the selected 2D part in the part list, based on the respective settings.
Apply New Variable	Applies the threshold settings to the separation and attachment line segments based on the threshold variable that is highlighted in the Select Threshold Variable list.
<i>Advanced</i>	Will open the Feature Detail Editor and select the Separation/Attachment icon for more advance control of the Separation/Attachment Part.
Feature Detail Editor (Separation/Attachment)	Double clicking on the Separation/Attachment Lines Icon opens the Feature Detail Editor (Separation/Attachment Lines), the Creation Attributes Section of which provides access to the same functions available in the Quick Interaction Area, as well as one more.  <a href="#">(see Section 3.3, Part Editing</a> for a detailed discussion of the remaining Feature Detail Editor turn-down sections which are the same for all Parts),
Display offset	This field specifies the normal distance away from a surface to display the separation/attachment lines. A positive value moves the lines away from the surface in the direction of the surface normal.  <i>Please note that there is a hardware offset that will apply to contours, vector arrows, separation/attachment lines, and surface restricted particle traces that can be turned on or off in the View portion of Edit-&gt;Preferences. This preference (“Use graphics hardware to offset line objects...” ) is on by default and generally gives good images for everything except move/draw printing. This hardware offset differs from the display offset in that it is in the direction perpendicular to the computer screen monitor (Z-buffer).</i>  Thus, for viewing, you may generally leave the display offset at zero. But for printing, a non-zero value may become necessary so the lines print cleanly.

*Note: Separation and Attachment Line feature extraction does not work with multiple parts.*

### Troubleshooting Separation/Attachment Lines

Problem	Probable Causes	Solutions
Error creating separation and attachment lines	Invalid part selected in part list	Highlight 2D or 3D part
Undefined (colored by part color) regions on sep/attach lines	Sep/Attach line segment node was not mapped within a corresponding 3D field element	Make sure corresponding 3D field part is defined.
Separation/attachment lines do not print well.	See Display Offset discussion above	Enter a non-zero Display Offset

## 7.18 Boundary Layer Variables Create/Update

EnSight creates the following Boundary Layer Variables simultaneously on a 2D boundary part directly from velocity information of its corresponding 3D flow field part. Their corresponding variable names are included in all appropriate EnSight variable lists, i.e. Color Parts variable list, etc.

Variable Name	Description	Symbol
(N) bl_thickness	Boundary layer thickness	$\delta$
(N) bl_disp_thickness	Displacement thickness	$\delta^*$
(N) bl_momen_thickness	Momentum thickness	$\Theta$
(N) bl_shape_parameter	Shape parameter	H
(N) bl_skin_friction_Cf	Skin friction coefficient	$C_f$

Only nodal (values per node) variables are created. Any dependent elemental variables (values per element) are averaged to nodal variables before processing. (See [Definitions](#) below.)

Whether these variables are mapped onto the 2D boundary part, or used in conjunction with other EnSight features (such as Elevated Surfaces of the boundary layer thickness off the 2D boundary part, Vortex Cores, Separation and Attachment Lines, Shock, etc.), these variables help provide valuable insight into the formation and location of possible boundary layers.

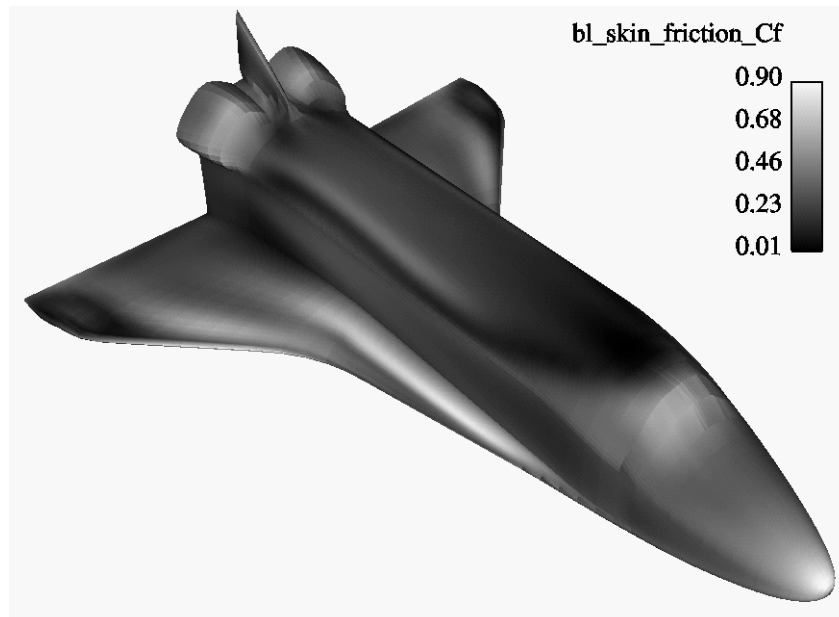

Figure 7-92  
Skin Friction Coefficient

### Boundary Layer

A boundary layer is a relatively thin region that confines viscous diffusion near the surface of a flow field, where the velocity gradient in the normal direction to the surface goes through an abrupt change. Although multiple boundary layers may be considered (especially in areas of flow separation), our current

implementation provides boundary layer parameters based on the former concept. In these thin regions, the thickness of the boundary layer typically increases in the downstream direction, and the velocity parallel to the surface is much larger than the velocity normal to the surface.

**Boundary Surfaces** Boundary parts are typically 2D surface part(s) that correspond to a 3D field. These surfaces may either be boundary parts defined directly from the data file, or created parts (i.e. 2D IJK sweeps of a structured part, or an isosurface of zero velocity of either an unstructured or structured part).

**Velocity-Magnitude Gradient Vector** Changes of the velocity in the normal direction from the surface into the 3D flow field are utilized to determine the boundary layer. EnSight automatically creates a velocity-magnitude gradient vector for all 3D model parts prior to creating the boundary layer variables. These gradient values are then mapped to all corresponding 2D model parts, and inherited by all created parts.

*Note: The velocity-magnitude gradient vector variable will continue to be created for all 3D model parts until it is deactivated.*

This vector variable behaves like any other created variable, and may be deactivated via the Feature Editor (Variables) dialog.

## Definitions

### Boundary Layer Thickness

$$\delta = \bar{n} \Big|_{u/U = 0.995}$$

The distance normal from the surface to where  $u/U = 0.995$ ,  
 where:  $u$  = magnitude of the velocity at a given location in the boundary layer,  
 $U$  = magnitude of the velocity just outside the boundary layer.

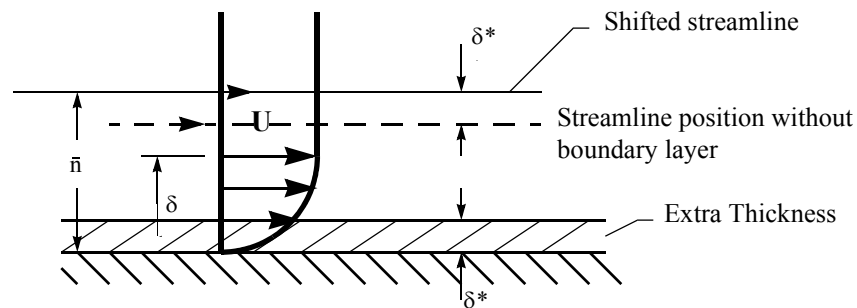

**Displacement Thickness** 
$$\delta^* = \frac{1}{U} \int_0^{\delta} (U - u) dn$$

Provides a measure for the effect of the boundary layer on the “outside” flow. The boundary layer causes a displacement of the streamlines around the body.

**Momentum Thickness** 
$$\Theta = \frac{1}{U^2} \int_0^{\delta} (U - u) u dn$$

Relates to the loss of momentum in the air in the boundary layer.

## Shape Parameter

$$\delta^*/\Theta$$

Used to characterize boundary layer flows, especially to indicate potential for separation.

This parameter increases as a separation point is approached, and varies rapidly near a separation point.

*Note: Separation has not been observed for  $H < 1.8$ , and definitely has been observed for  $H = 2.6$ ; therefore, separation is considered in some analytical methods to occur in turbulent boundary layers for  $H = 2.0$ .*

*In a Blasius Laminar layer (i.e. flat plate boundary layer growth with zero pressure gradient),  $H = 2.605$ . Turbulent boundary layer,  $H \sim 1.4$  to  $1.5$ , with extreme variations  $\sim 1.2$  to  $2.5$ .*

## Skin Friction Coefficient

$$C_f = \frac{\tau_w}{0.5\rho_\infty(V_\infty)^2}$$

where:  $\tau_w = \mu \left( \frac{\partial u}{\partial n} \right)_{n=0}$  = fluid shear stress at the wall.

$\mu$  = dynamic viscosity of the fluid.

May be spatially and/or temporarily varying quantity (usually a constant).

$n$  = distance normal to the wall.

$\rho_\infty$  = freestream density

$V_\infty$  = freestream velocity magnitude.

This is a non-dimensionalized measure of the fluid shear stress at the surface. An important aspects of the Skin Friction Coefficient is:

$C_f = 0$ , indicates boundary layer separation.

## Other Notes:

Factor Determining Velocity at Boundary-Layer Thickness ( $\delta$ )

The factor (default = 0.995) which determines the velocity magnitude ( $u$ ) at the boundary-layer thickness ( $\delta$ ) with respect to the velocity magnitude ( $U$ ) just outside the boundary layer (i.e.  $\delta$  is the distance normal to the surface at which  $u = 0.995U$ ), may be changed by issuing the following command via the command line processor (see [Section 2.5, Command Files](#)):

```
test: blt_factor #
```

where # is the corresponding factor ( $> 0$ ).

## References

Please refer to the following texts for more detailed explanations.

P.M. Gerhart, R.J. Gross, & J.I. Hochstein, Fundamentals of Fluid Mechanics, 2nd Ed., (Addison-Wesley: New York, 1992),

C.A.J. Fletcher, Computational Techniques for Fluid Dynamics, Vol. 2, 2nd Ed., (Springer: New York, 1997)

**Access**

Clicking once on the Boundary Layer Variable Create/Update Icon opens the Boundary Layer Variables Editor in the Quick Interaction Area, which is used to both create and update (make changes to) the boundary layer variables.



Figure 7-93  
Boundary Layer Variables Create/Update Icon

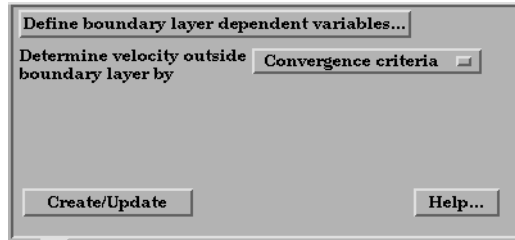

Figure 7-94  
Quick Interaction Area - Boundary Layer Variables Editor

**Define Boundary Layer Dependent Variables...**

Opens the Boundary Layer Variable Settings dialog which allows the user to identify and set the dependent variables used in computing the boundary layer variables (see Definitions above). This dialog has a list of current accessible variables to choose from. Immediately below is a list of dependent variables with corresponding text field and SET button. The variable name in the list is tied to a dependent variable below by first highlighting a the listed variable, and then clicking the corresponding dependent variable's SET button, which inserts the listed variable into its corresponding text field.

All text fields are required, except you may specify either Density and Momentum (which permits velocity to be computed on the fly), or Velocity. Default constant values are provided which may be changed by editing the text field.

Clicking Okay activates all specified dependent variables and closes the dialog.

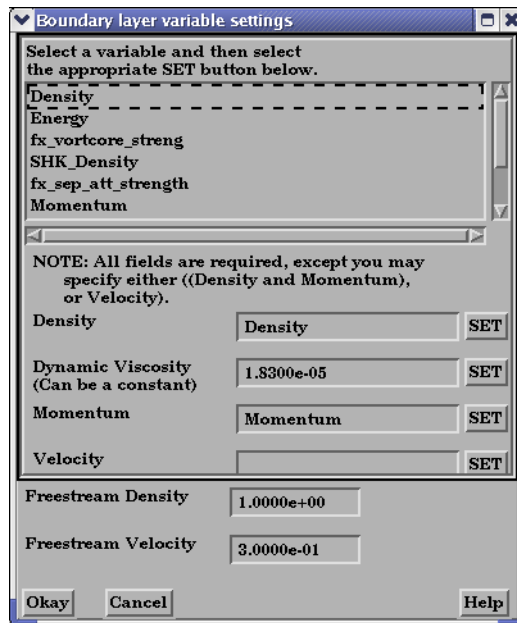

Figure 7-95  
Boundary Layer Variable Settings Dialog

**Determine Velocity**

Opens a pop-up dialog for the specification of which type of method to determine the

Outside Boundary  
Layer By

constant velocity just outside the boundary layer (U) (see Definitions above). The following options determine (U) at each node of the surface in the direction normal from the surface into the 3D field by:

*Convergence Criteria* - monitoring the velocity profile until either the velocity magnitude goes constant or its gradient goes to zero.

*Distance From Surface* - specifying the Normal Distance from the surface into the field at which to extract the velocity and assign as U. Then monitor the velocity profile from the surface into the field until U is obtained.

*Normal Distance* - Text field that contains the distance normal from the surface into the 3D field at which to extract the velocity for U.

*Velocity Magnitude* - specifying the Velocity Magnitude to assign as U. Then monitor the velocity profile from the surface into the field until U is obtained.

*Velocity Magnitude* - Text field that contains the specified velocity magnitude to assign as U.

*Note: Boundary Layer Variable feature extraction does not work with multiple parts.*

### Troubleshooting Boundary Layer Variables

Problem	Probable Causes	Solutions
Error creating boundary layer variables.	Non-2D part selected in part list.	Highlight 2D part.
Undefined (colored by part color) regions on boundary surface.	2D boundary surface node was not mapped to corresponding 3D field boundary node.	Make sure corresponding 3D field part is defined.

## 7.19 Material Parts Create/Update

EnSight enables you to create and modify Material Parts from material descriptions defined on model parts. The Material Parts feature allows you to extract single or combined regions of specified materials, as well as boundary interfaces between two or more specified materials.

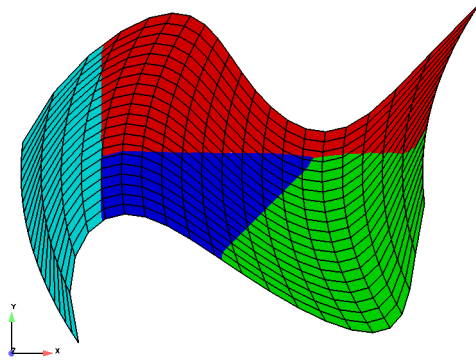

Figure 7-96  
Material Parts Illustration

Material Parts can only be created from model parts that have material ids assigned to them. Therefore, Material Parts can not be created from any Measured or Created Parts. In addition, material information is not transferred to Created Parts.

Material Parts are created and reside on the server. They are Created Parts that provide proper updating of all dependent parts and variables - except they do not inherit any material data themselves.

Material Parts are created and modified by specifying parent model parts, as well as selecting material descriptions listed in the Materials List. A Material Part is extracted from only 2D and 3D elements. A Material Part is created as either a Domain or an Interface.

<b>Domain</b>	A material Domain defines a solid region composed of one or more specified materials. Parts with 2D elements yield 2D material elements, and parts with 3D elements yield 3D material elements.
<b>Interface</b>	A material Interface defines a boundary region between at least two or more adjacent specified materials. Parts with 2D elements yield 1D material elements, and parts with 3D elements yield 2D material elements.
<b>Null Materials</b>	Two categories of materials are reflected in the Materials List; namely, given materials and a “null_material”. All given material descriptions correspond to a material assigned a positive material number, or id. Any material that has an id less than or equal zero ( $\leq 0$ ) is grouped under the “null_material” and assigned the material id of zero (0). This allows the null material to act as a valid material. The “null_material” description always appears in the Materials List whether or not there are any null materials.



Subdividing	Each 3D (or 2D) element of the part is first decomposed into tetrahedrons (or triangles) before it is processed. You can increase element resolution of the Material Part by increasing the Subdivide level. There are three levels of subdivision. The first level simply processes each of the decomposed (tetrahedral or triangular) elements. The second level, subdivides each of the decomposed elements into three sub-elements, and then processes all three of these sub-elements in place of the decomposed element. The third level, subdivides each of the decomposed elements into six sub-elements, and then processes these six sub-elements in place of the original decomposed element.
Algorithm	The algorithm implemented is based on a probability based approach to material interface reconstruction (see reference below). Essentially volume fractions are averaged for every cell to its nodes, edges/faces, and center. Each cell is then decomposed and/or subdivided into subcells. Each subcell is then repeatedly assigned, compared, and appropriately interpolated with volume fractions for each material. The resulting material cells reflect the maximum volume fraction portion(s) of the interpolated subcells.
References	Meredith, Jeremy S. "A Probability Based Approach to Material Interface Reconstruction for Visualization", ECS277 Project 4, Spring 2001
Caveats	Material resolution tends to diminish (and at times distorts) at boundary cells that lack adjacent ghost cells. The volume fractions at these cells simply lack the proper weighting. This is remedied by providing material ghost cells.  Thus, materials that contribute half or less of the total portion on a boundary element, typically do not appear without ghost cells
Access	Clicking once on the Material Parts Create/Update Icon opens the Material Parts Editor in the Quick Interaction Area which is used to both create and update (make changes to) the material parts.



Figure 7-97  
Material Parts Create/Update Icon

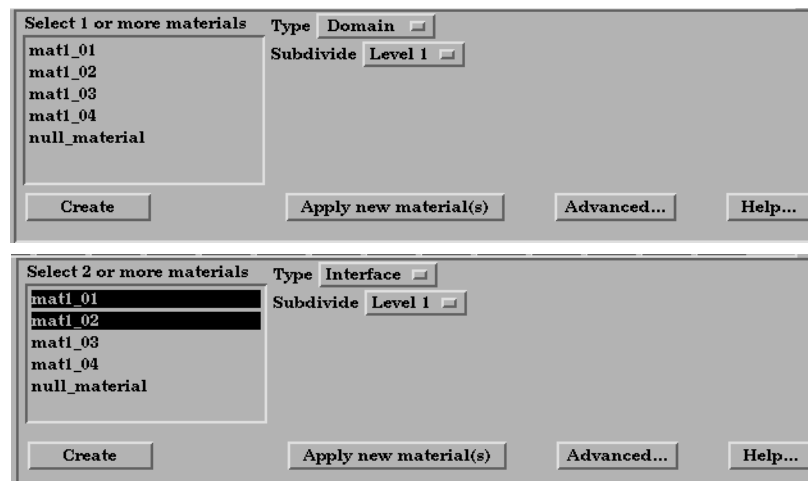

Figure 7-97  
Quick Interaction Area - for Material Parts Type Domain/Interface

## 7.19 Material Parts Create/Update

Materials List	List reflecting the available materials in the model parts. Any material that has an id less than or equal to zero ( $\leq 0$ ) comprises the “null_material”.
Type	Opens a pull-down menu for specification of whether the Material Part results in a Domain or Interface. Changing the Type of existing Material Parts will automatically update them to the new specified type.  <i>Domain</i> Creates a solid region composed of one or more specified materials. Parts with 2D elements yield 2D material elements, and parts with 3D elements yield 3D material elements.  <i>Interface</i> Creates a boundary region between at least two or more specified materials. Parts with 2D elements yield 1D material elements, and parts with 3D elements yield 2D material elements.
Subdivide	Opens a pull-down menu for selection of the level to subdivide the decomposed (tetrahedral and/or triangular) elements. Changing the Type of existing Material Parts will automatically update them to the new specified type.  <i>Level 1</i> Simply processes each of the original decomposed (tetrahedral and/or triangular) elements.  <i>Level 2</i> Subdivides each decomposed tetrahedral (and/or triangular) element into 3 more tetrahedrons (and/or triangles) prior to processing.  <i>Level 3</i> Subdivides each decomposed tetrahedral (and/or triangular) element into 6 more tetrahedrons (and/or triangles) prior to processing.
Apply New Material(s)	Recreates the Material Part selected in the Main Parts List according to the selections in the material list.
<i>Advanced</i>	Will open the Feature Detail Editor and select the Material icon for more advance control of the Material Part.

### Feature Detail Editor (Material Parts)

Double Clicking on the Material Parts Create/Update Icon (or Edit > Part Feature Detail Editors > Materials Parts...) opens the Feature Detail Editor (Material Parts), the Creation Attributes of which offers the same options for the Material Parts as the Quick Interaction Area Editor.

(See: [How To Create Material Parts](#), and under [Section 11.1, EnSight Gold Casefile Format](#), see [EnSight Gold Material Files Format](#))

## Troubleshooting Material Parts

Problem	Probable Causes	Solutions
No Type Domain Material Part created for specified material description(s)	Model part(s) not selected.	Select only model part(s).
	Model part(s) void of that material	Nothing wrong.
No Type Interface Material Part created for specified material description(s)	Model parts not selected.	Select only model part(s).
	Two or more materials not selected.	Select at least two (or more) materials.
	Selected materials are not adjacent across a 3D face or 2D edge.	Nothing wrong.
No “null_material” Material Part created for a specified “null_material” selection.	Model parts do not contain any null materials.	Nothing wrong.
There are no null materials, but selecting “null_material” produces a visible region.	Incorrect indexing in the material ids file.	Material ids file possibly has a negative index to an incorrect position into the mixed-material id file.
Increasing the Subdivide level does not increase the material fraction detail	Increasing the Subdivide level typically only increases the element resolution.	Typically nothing wrong.
Changing the Type and/or Level as well while simultaneously changing the material selections did not update the selected Material Part to the new material selections.	Material reselection is only updated via the Apply New Material(s) button.	Update the new materials first, then change the type.
		Delete the Material Part. Make new material(s) selection and Type and/or Subdivide specification. Then Create a new Material Part.

## 7.20 Developed Surface Create/Update

A Developed Surface is generated by treating any 2D Part (or parent Part) as a surface of revolution, and mapping specific curvilinear coordinates of the revolved surface into a planar representation.

A Developed Surface derives its name from the implied process that defines a developable surface. A surface is considered “developable” if it can be unrolled onto a plane without distortion. Although every 2D Part in EnSight is not by definition a developable surface, each 2D Part can nevertheless be developed into a planar surface which is distorted according to the type of developed projection specified. For example, a Cylinder Clip Part is by definition a developable surface, because it can be developed into planar surface without distortion. Whereas, a Sphere Clip Part is not a developable surface, because it can not be developed into a planar surface without distortion.

### *Parent Parts*

Only 2D Parts are developed. Also, only one Part is developed at a time. While all 2D Parts qualify as candidate parent Parts, only 2D Parts of revolution are developed coherently. The current developed surface algorithm treats all parent Parts as surfaces of revolution that are developed according to a local origin and axis of revolution. These attributes are either inherited from the parent Part, or must be specified according to the parent Part.

A developed surface permanently inherits the local origin and axis of revolution information from any parent Part created via the cylinder, cone, sphere, or revolution Clip tools. Whereas, surfaces developed from non-Clip Parts require this information to be specified via the Orig. and Axis fields in the Attributes (Developed Surfaces) dialog. The latter case is the only time the values in these fields are used. Although default values are provided, it is up to you to make sure that valid values are specified. In the former case, the Orig and Axis fields only provide convenient feedback of the selected Clip Part. Note that developed surfaces resulting from parent Parts of revolution created via the general quadric Clip tool do not inherit the local origin and axis of revolution attributes from the General Quadric Clip parent; rather, these attributes must be specified.

Figure 7-98  
Developed  
Surface  
Examples

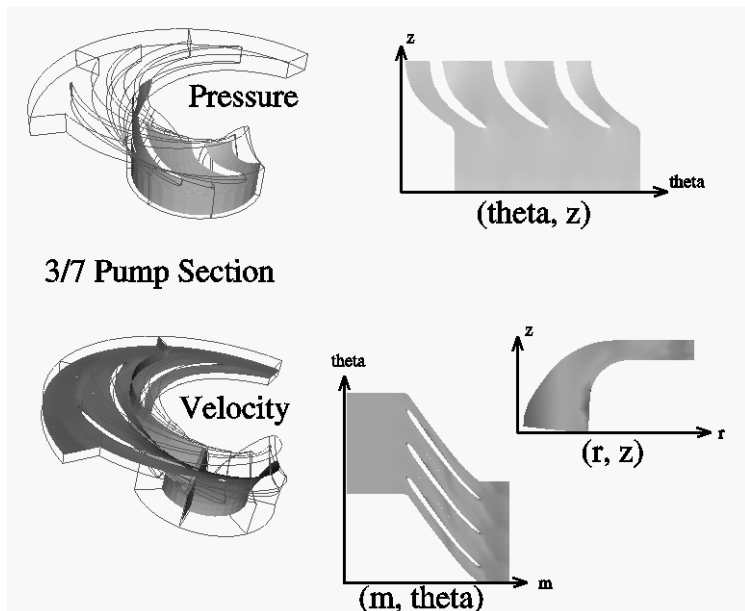

*Developed Projections* A parent Part is developed by specifying one of three curvilinear mappings called *developed projections*; namely, an  $(r,z)$ ,  $(\theta,z)$ , or  $(m,\theta)$  projection. The curvilinear coordinates  $r$ ,  $\theta$ ,  $z$ , and  $m$  stand for the respective radius,  $\theta$ ,  $z$ , and meridian (or longitude) directional components which are defined relative to the local origin and axis of revolution of the parent Part. The meridian component is defined as  $m = \text{SQRT}(r^2 + z^2)$ .

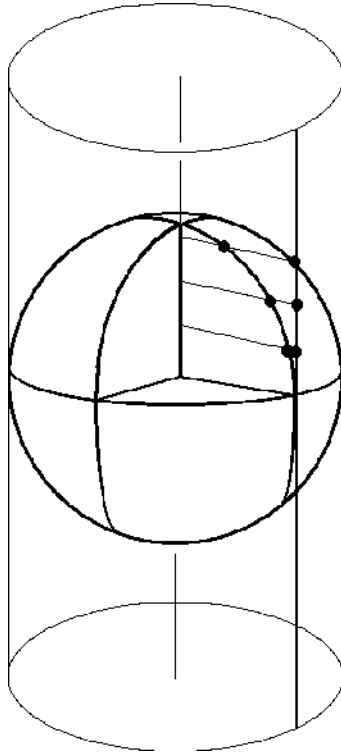

Figure 7-99  
Developed Equiareal Projection

Essentially, each topological projection first surrounds the parent Part of revolution with a virtual cylinder of constant radius. The curvilinear coordinates of the parent Part are then projected along the normals of (and thus onto) the virtual cylinder. Finally, the virtual cylinder is slit along a straight line, or generator, and unwrapped into a plane. This process yields an *equiareal*, or *area preserving*, mapping which means that the area of any enclosed curve on the surface of the parent Part is equal to the area enclosed by the image of the enclosed curve on the developed plane. Although equiareal mappings provide reduced shape distortion, they do suffer from angular distortions of local scale.

Vector fields of the parent Part (for all three developed projections) are developed such that a vector's angle to its surface normal is preserved. For example, a vector normal to the parent surface remains normal when developed onto the planar surface.

### *Seam Line*

A surface of revolution is developed about its axis, starting at its "seam" line (or zero meridian) where the surface is to be slit. Surface points along the seam are duplicated on both ends of the developed Part. The seam line is specified via a vector that is perpendicular to and originates from the axis of revolution, and which points toward the seam which is located on the surface at a constant value. This vector can be specified either manually or interactively. Interactive seam line display and manipulation is provided via a slider in the Attributes (Developed Surfaces) dialog.

Clicking once on the Developed Surface Create/Update Icon opens the Developed Surface Editor in the Quick Interaction Area which is used to both create and update (make changes to) developed surface Parts.

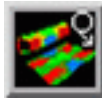

Figure 7-100  
Developed Surface Create/Update Icon

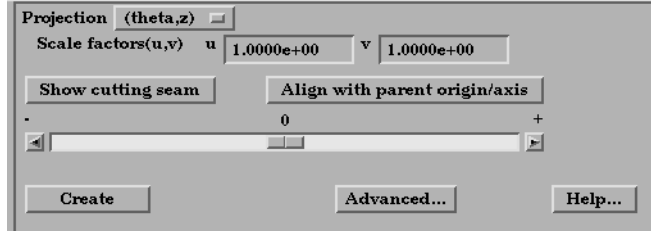

Figure 7-101  
Quick Interaction Area - Developed Surface Editor

**Projection**

Opens a pop-up dialog for the specification of which type of (u,v) projection, or mapping, you wish to use for developing a surface of revolution; where u,v denotes curvilinear components of the parent Part that are mapped into the xy-plane of reference Frame 0. The options are:

- (m,r) denotes the meridian and radial components of the revolved surface
- (m,theta) denotes the meridian and theta components of the revolved surface.
- (r,z) denotes the radial and z-directional components of the revolved surface
- (theta,z) denotes the theta and z-directional components of the revolved surface.
- (m,theta) denotes the meridian and theta components of the revolved surface.

The meridian component is the curvilinear component along a revolved surface that runs in the direction of its axis of revolution (e.g. the meridional and z-directional components along a right cylinder are coincident, and for a sphere the meridian is the longitude).

**Scale Factors (u,v)**

These fields specify the scaling factors which will be applied to the u and v projections.

**Show Cutting Seam**

Click this button to display the current seam line location about the circumference of the revolved surface. The seam line is manipulated interactively via the Slider Bar.

**Align with Parent Origin/Axis**

Retrieves the Origin and Axis information from the Parent Part. Must be done if Parent Part is a quadric clip.

**Feature Detail Editor (Developed Surfaces)**

Double clicking on the Developed Surface Create/Update Icon opens the Feature Detail Editor for Developed Surfaces, the Creation Attributes Section of which provides access to all of the functions available in the Quick Interaction Area plus several more:

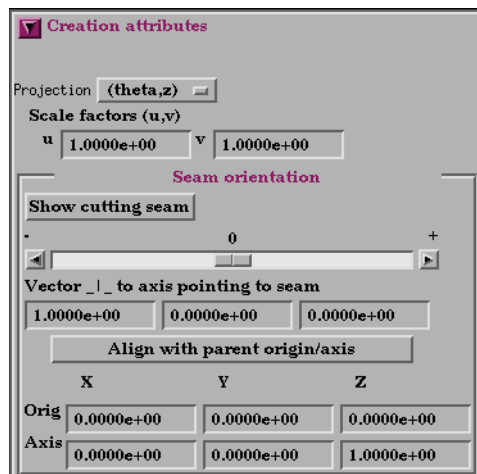

Figure 7-102  
Feature Detail Editor (Developed Surfaces)

<i>Vector __ To Axis Pointing To Seam</i>	These fields allow you to precisely specify the position of the Cutting Seam Line by specifying the direction of the vector perpendicular to the axis of revolution which points in the direction of the seam line.
Orig X Y Z	These fields specify a point on the axis of revolution.
Axis X Y Z	These fields specify a vector, which when used with the Axis Origin defines the axis of revolution.

The Feature Detail Editor also allows you to make changes in batch; that is, to make several changes to the menus and fields which do not effect the Graphics Window until you click in the Apply Changes button. It is sometimes quicker (with respect to CPU time) to make several changes at once rather than one at a time as in the Quick Interaction Area.

(see [Section 3.3, Part Editing](#) for a detailed discussion of the remaining Feature Detail Editor turn-down sections which are the same for all Parts),

(see [How To Create Developed \(Unrolled\) Surfaces](#))

### *Troubleshooting Developed Surfaces*

Problem	Probable Causes	Solutions
Error message is encountered while creating a Developed Surface Part.	Parent Part is invalid.	Only 2D Parts can be developed.
Developed Surface is created, but is either not visible, Partially visible, or obstructed by other Parts which may be other developed Parts	Since all Developed Surfaces are projected about the origin on the xy-plane of the reference frame of the parent Part, they may map outside the viewport, intersect other Parts, or pile up on each other.	Set the Developed Surface to be viewed in its own viewport and initialize the viewport.  Use different u/v scaling.  Assign the developed Part to its own local reference frame and transform it accordingly.
Developed Surface Part is a line.	Wrong Projection type was specified.	Select a different Projection.
Developed Surface Part does not update to new Orig and/or Axis values.	The Orig and Axis values can not be specified if the Parent Part is created from either a cylinder, sphere, cone, or revolution quadric clip. These values can only be specified if the 2D parent Part is not a quadric clipped surface.	Since values entered for this condition are not used, click the Get Parent Part Defaults button to update the fields based on the selected parent Part in the Parts & Frames list.

## 7.21 Tensor Glyph Parts Create/Update

Tensor glyphs visualize the direction and tension/compression of the eigenvectors at discrete points (at nodes or at element centers) for a given tensor variable.

Tensor glyph Parts are dependent Parts known only to the client. They cannot be used as a parent Part for other Part types and cannot be used in queries. As dependent Parts, they are updated anytime the parent Part and/or the creation tensor variable changes (unless the general attribute Active flag is off).

Tensor glyphs can be filtered to show just the tensile or compressive eigenvectors. Further, the visibility for each of the eigenvectors (Major, Middle, and Minor) can be controlled.

Tensor glyphs will appear for each of the nodes/elements for the Parent part's visual Representation. Thus, for a border Representation of a Part, only the border nodes/elements will be candidates for a tensor glyph.

The tensile and compressive eigenvectors can be visualized by modifying the tensile/compressive component's line width and color.

Clicking once on the Tensor Glyph Create/Update Icon opens the Tensor Glyph Editor section of the Quick Interaction Area which is used to both create and update (make changes to) tensor glyph Parts.



Figure 7-103  
Tensor Glyph Parts Create/Update Icon

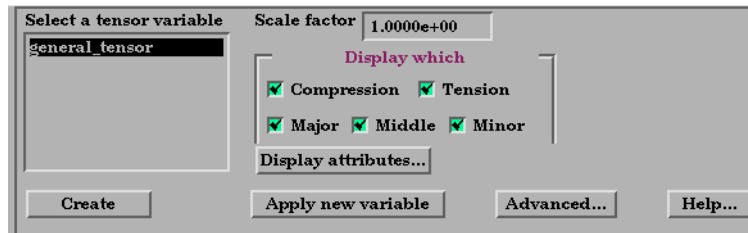

Figure 7-104  
Quick Interaction Area - Tensor Glyph Parts Editor

*Scale Factor*

The size of the tensor glyph.

*Display Which*

Controls which eigenvectors will be displayed

Compression	Show the eigenvectors that are in compression
Tension	Show the eigenvectors that are in tension
Major	Show the major eigenvector
Middle	Show the middle eigenvector
Minor	Show the minor eigenvector



*Display Attributes*

Opens the Tensor Display Attributes dialog.

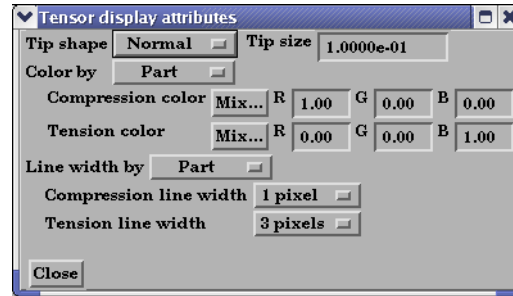

Figure 7-105  
Tensor Display Attributes Dialog

<i>Tip Shape</i>	Opens a pop-up menu to select the tip shape						
	<table border="0"> <tr> <td>None</td> <td>Displays eigenvectors as lines with no tips.</td> </tr> <tr> <td>Normal</td> <td>Displays “classical” tips.</td> </tr> <tr> <td>Triangles</td> <td>Displays triangle tips.</td> </tr> </table>	None	Displays eigenvectors as lines with no tips.	Normal	Displays “classical” tips.	Triangles	Displays triangle tips.
None	Displays eigenvectors as lines with no tips.						
Normal	Displays “classical” tips.						
Triangles	Displays triangle tips.						
<i>Tip Size</i>	Controls the size of the tips.						
<i>Color By</i>	The tensor glyphs can be colored according to the part color, or have a separate color for compression and tension. <table border="0" style="margin-left: 20px;"> <tr> <td>Compression Color</td> <td>Specify the compressive color</td> </tr> <tr> <td>Tension Color</td> <td>Specify the tensile color</td> </tr> </table>	Compression Color	Specify the compressive color	Tension Color	Specify the tensile color		
Compression Color	Specify the compressive color						
Tension Color	Specify the tensile color						
<i>Line Width By</i>	The tensor glyphs can use the part line width, or have a separate line width for compression and tension. <table border="0" style="margin-left: 20px;"> <tr> <td>Compression Line Width</td> <td>Specify the compressive line width</td> </tr> <tr> <td>Tension Line Width</td> <td>Specify the tensile line width</td> </tr> </table>	Compression Line Width	Specify the compressive line width	Tension Line Width	Specify the tensile line width		
Compression Line Width	Specify the compressive line width						
Tension Line Width	Specify the tensile line width						
<i>Apply New Variable</i>	Changes the tensor Variable used to create the Tensor Glyphs to that currently selected in the “Select a Tensor Variable” list.						
<i>Advanced</i>	Will open the Feature Detail Editor and select the Vector Arrow icon for more advance control of the Vector Arrow Part.						
<i>Feature Detail Editor (Tensor Glyph)</i>	Double clicking on the Tensor Glyph Create/Update Icon opens the Feature Detail Editor for Tensor Glyphs, the Creation Attributes Section of which provides access to the same functions available in the Quick Interaction Area. For a detailed discussion of the remaining Feature Detail Editor turn-down sections (which are the same for all Part types) (see <a href="#">Section 3.3, Part Editing</a> and <a href="#">How to Create Tensor Glyphs</a> )						

*Troubleshooting Tensor Glyphs*

Problem	Probable Causes	Solutions
No tensor glyphs created	No real eigenvectors exist.	None
	Scale Factor too small.	Increase Scale Factor.
	Parent parts have non-visual attributes.	Re-specify parent parts or modify parent part's Element Representation.
	Parent parts do not contain selected tensor variable.	Re-specify parent parts.
Too many glyphs	Parent parts have too many points at which tensor glyphs are to be displayed.	Consider using a grid clip as the parent part.

# 8 Modes

This chapter describes the five different Modes through which you can work in the Graphics Window as well as the Quick Desktop Buttons that are located above the Graphics Window. The “active” Mode determines both the configuration and what functions are available through the Mode Icon Bar. The Quick Desktop Buttons are always available regardless of the mode and are useful as quick shortcuts for often-used tasks.

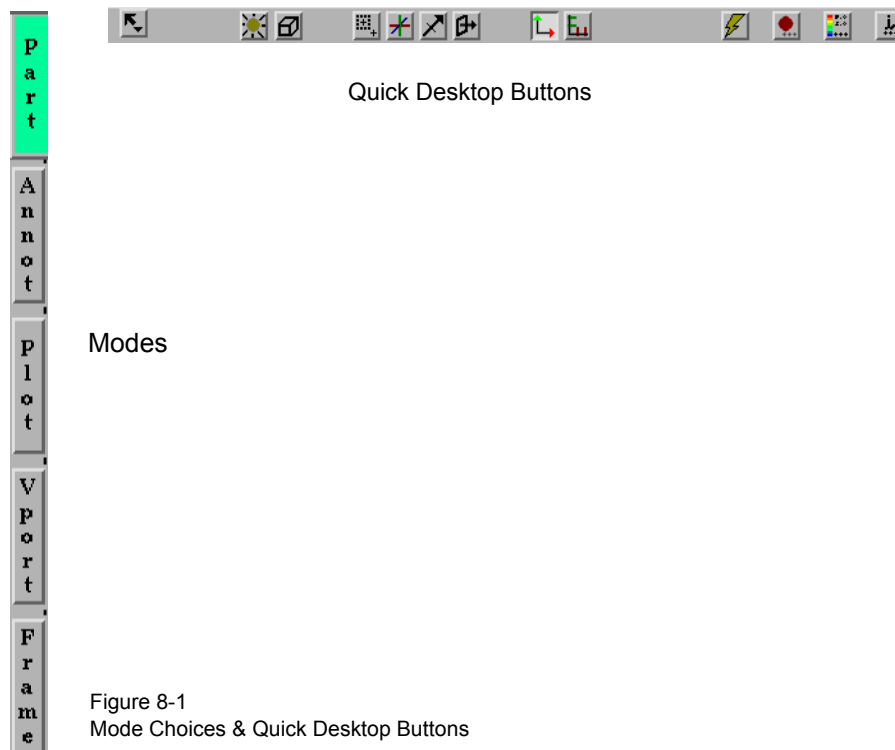

**Section 8.1, Part Mode** describes the layout of the Mode Icon Bar and the functions available when **Part** is the active Mode.

**Section 8.2, Annot Mode** describes the layout of the Mode Icon Bar and the functions available when **Annot** is the active Mode.

**Section 8.3, Plot Mode** describes the layout of the Mode Icon Bar and the functions available when **Plot** is the active Mode.

**Section 8.4, VPort Mode** describes the layout of the Mode Icon Bar and the functions available when **VPort** is the active Mode.

**Section 8.5, Frame Mode** describes the layout of the Mode Icon Bar and the functions available when **Frame** is the active Mode. *By default, this mode is not available unless it has been enabled under Edit > Preferences... General User Interface - Frame Mode Allowed*

**Section 8.6, Quick Desktop Buttons** describes the layout of the Quick Desktop Buttons which are always available.

## 8.1 Part Mode

Part Mode is used to adjust a number of attributes for individual Parts and to specify the desired type of Pick operation.

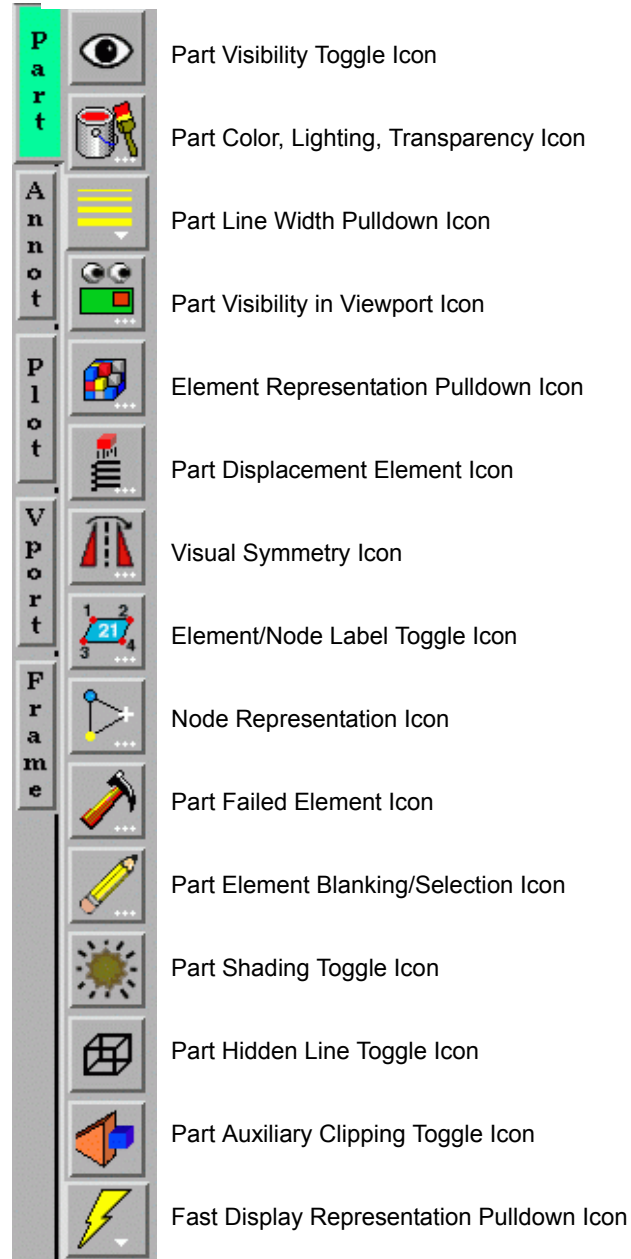

Figure 8-2  
Mode Selection Area - Part Selected

For a complete discussion about Parts:

(see [Chapter 3, Parts](#))

*Part Visibility  
Toggle Icon*

Determines the global (in all viewports and in all Modes) visibility of the selected Part(s).



Figure 8-3  
Part Mode - Part Visibility Toggle ON - OFF Icons

*Part Color, Lighting,  
Transparency Icon*

Clicking once on the Part Color, Lighting, Transparency Icon opens a dialog which allows you to assign color, lighting characteristics, and transparency levels to the individual Part(s) which has(have) been selected in the Parts List. If no Parts are selected, modifications will affect the default Part color and all Parts subsequently loaded or created will be assigned the new default color.



Figure 8-4  
Part Color, Lighting, Transparency Icon

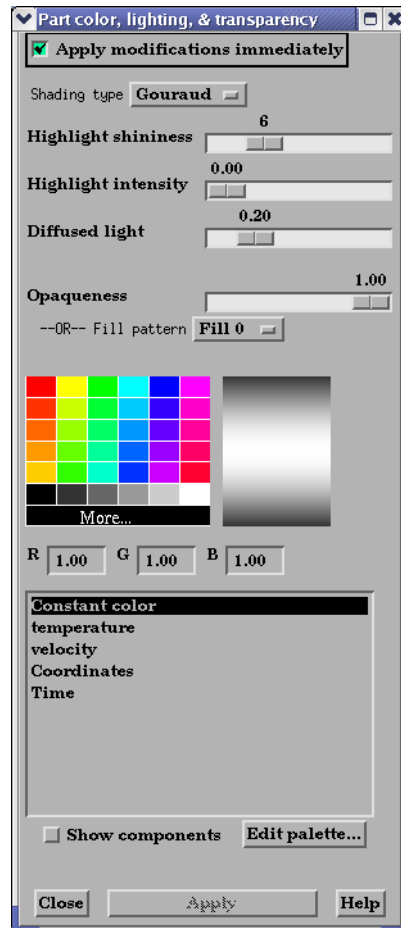

Figure 8-5  
Part Mode - Part Color, Lighting & Transparency dialog

*Apply modifications  
immediately*

If toggled on, each change made in this dialog will be reflected immediately in the graphics window. If it is toggled off, one can make several changes, then hit the Apply button at the bottom of the dialog to cause them to take effect.

- Shading Type** Opens a pop-up menu for selection of appearance of Part surface when Shaded Surface is on. Normally the mode is set to Gouraud, meaning that the color and shading will interpolate across the polygon in a linear scheme. You can also set the shading type to Flat, meaning that each polygon will get one color and shade, or Smooth which means that the surface normals will be averaged to the neighboring elements producing a “smooth” surface appearance. Not valid for all Part types. Options are:  
*Flat* Color and shading same for entire element  
*Gouraud* Color and shading varies linearly across element  
*Smooth* Normals averaged with neighboring elements to simulate smooth surfaces
- Highlight Shininess** Shininess factor. You can think of the shininess factor in terms of how smooth the surface is. The larger the shininess factor, the smoother the object. A value of 0 corresponds to a dull finish and larger values correspond to a more shiny finish. To change, use the slider.
- Highlight Intensity** Highlight intensity (the amount of white light contained in the color of the Part which is reflected back to the observer). Highlighting gives the Part a more realistic appearance and reveals the shine of the surface. To change, use the slider. Will have no effect if Highlight Shininess parameter is zero.
- Diffused Light** Diffusion (minimum brightness or amount of light that a Part reflects). (Some applications refer to this as *ambient* light.) The Part will reflect no light if value is 0.0. If value is 1.0, no lighting effects will be imposed and the Part will reflect all light and be shown at full color intensity at every point. To change, use the slider.
- Opaqueness** The opaqueness of the selected Part(s). A value of 1.0 indicates that the Part is fully opaque, while a value of 0.0 indicates that it is fully transparent. Setting this attribute to a value other than 1.0 can seriously affect the graphics performance. Opacity is disabled for line parts and for particle trace parts (line, ribbon, tubes). To get the effect of opacity for particle trace ribbons or tubes, use the “screen door” transparency in the Fill Pattern pulldown described below.
- Fill Pattern** Opens a pop-up menu for selection of a fill pattern which can provide pseudo-transparency for shaded surfaces. Default is Fill 0 which uses no pattern (produces a solid surface), while Fill patterns 1 through 3 produce a EnSight defined fill pattern.
- Color By Area** Allows you to choose whether to color the selected Part(s) by a Constant Color or by the Variable selected in the Variables List.
- Constant Color** The selected Part(s) may be assigned a constant color by selecting it from the pre-defined matrix of color cells or by entering red, green, and blue numerical values (0.0 to 1.0) in the R,G,B fields and then pressing the return key.
- More...** Alternatively, you can click on the More... area and the Color Selector dialog will open.

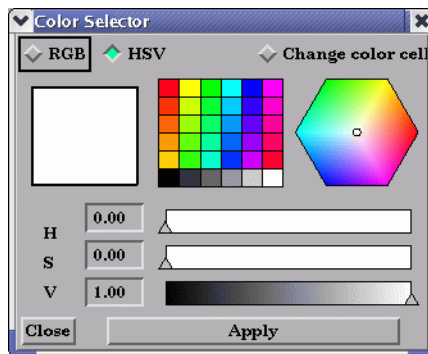

Figure 8-6  
Color Selector dialog

You can choose whether you wish to use the RGB color scheme or HSV. A color may be chosen in one of four ways. First, a color may be chosen from one of the color cells (small squares of constant color). Second, you can grab the small circle in the color assignment

hexagon and interactively pick the desired color. Third, you can pick a color by entering numerical values (0.0 to 1.0) in the numerical (RGB or HSV) fields and then pressing return key. Finally, you can interactively choose a color by using the slider bars to the right of the numerical (RGB or HSV) fields which adjust the values therein (the color in the slider bars indicates the effect that modifying the color components will have on the final color).

It is possible to assign to the Color Cells area a color that you have specified in one of the other three ways by clicking the Change Color Cell and then clicking on the cell to which you wish to assign the currently defined color (as shown in the large rectangle to the left). This reassignment will be retained for use in subsequent EnSight sessions.

Regardless of which method you use to define a color, it will not be applied to the selected Part(s) unless and until you click the Apply button.

#### Variables

Alternatively, the Part(s) may be colored by a variable selected in the list shown instead of by one constant color. The color palette for each Variable associates a color with each value of the variable and these colors are used to color the selected Part(s). If the Apply Modifications Immediately toggle is on, the part(s) will be colored immediately when the variable is selected. If the toggle is not on, you will need to click the Apply button at the bottom of the dialog to get the selection to take affect.

#### Show Components

If you are coloring by a vector variable, this toggle will expand the list to include the vector components - thus you can choose to color using the magnitude or a component of the vector.

#### Edit palette...

Clicking on Edit palette... will open the Feature Detail Editor (Variables) dialog. See [How To Edit Color Palettes](#)

#### Part Line Width Pulldown Icon

Opens a pulldown menu for the specification of the desired display width for Part lines. Performs the same function as the Line Representation Width field in the Node, Element, and Line Attributes section of the Feature Detail Editor (Model).



Figure 8-7  
Part Mode - Part Line Width Pulldown Icon

Access: Part Mode : Part Line Width Pull-down Icon

#### Part Visibility in Viewport Icon

Opens the “Part Visible in Which Viewport?” dialog. If the global visibility of a Part is on, this dialog can be used to selectively turn on/off visibility of the selected Part(s) in different viewports simply by clicking on a viewport’s border symbol within the dialog’s small window. The selected Part(s) will be visible in the green viewports invisible in the black viewports.

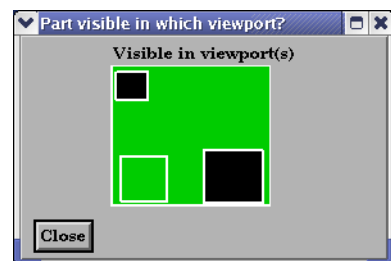

Figure 8-8  
Part Mode - Part Visibility in Viewport Icon and Part Visible in Which Viewport? dialog

**Element Visual Representation Pull-down Icon**

Access: Part Mode: Part Visibility in Viewport Icon  
 Opens a dialog for the specification of the desired representation for elements of the selected Part(s). Performs the same function as the Element Representation Visual Rep. pull-down menu in the Node, Element, and Line Attributes section of the Feature Detail Editor (Model).

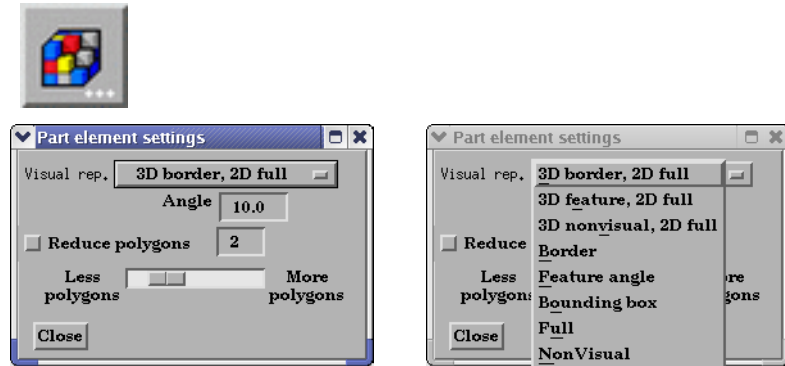

Figure 8-9  
 Part Mode - Element Representation Icon

(see Element Representation in [Section 3.3, Part Editing](#))

Access: Part Mode : Element Representation Pull-down Icon

**Part Displacement**

Opens the Part Displacement dialog which allows you to choose the vector variable. The model geometry is displaced by this variable vector value.

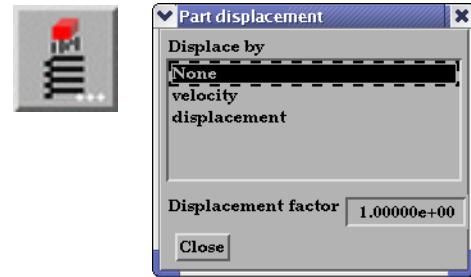

Displacement factor The vector variable can be scaled by this factor.

Each node of a Part is displaced by a distance and direction corresponding to the value of a vector variable at the node. The new coordinate is equal to the old coordinate plus the vector times the specified Factor, or:

$$C_{\text{new}} = C_{\text{orig}} + \text{Factor} * \text{Vector},$$

where  $C_{\text{new}}$  is the new coordinate location,  $C_{\text{orig}}$  is the coordinate location as defined in the data files, Factor is a scale factor, and Vector is the displacement vector.

You can greatly exaggerate the displacement vector by specifying a large Factor value. Though you can use any vector variable for displacements, it certainly makes the most sense to use a variable calculated for this purpose. Note that the variable value represents the *displacement* from the original location, not the *coordinates* of the new location.

**Displacement Factor** This field specifies a scale factor for the displacement vector. New coordinates are calculated as:  $C_{\text{new}} = C_{\text{orig}} + \text{Factor} * \text{Vector}$ , where  $C_{\text{new}}$  is the new coordinate location,  $C_{\text{orig}}$  is the original coordinate location as defined in the data file, Factor is a scale factor, and Vector is the displacement vector. Note that a value of 1.0 will give you “true” displacements.



*Visual Symmetry  
Icon*

Opens the Part Visual Symmetry dialog which allows you to control the display of mirror images of the selected Part(s) in each of the seven other quadrants of the Part's local frame or the rotationally symmetric instances of the selected parts. This performs the same function as the Visual Symmetry menu in the General Attributes section of the Feature Detail Editor (Model).

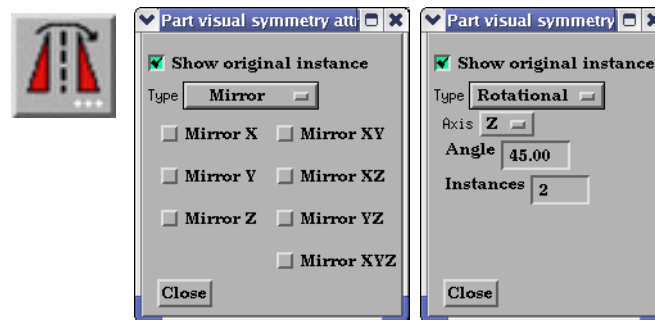

Figure 8-10  
Part Mode - Visual Symmetry Icon

Symmetry enables you to reduce the size of your analysis problem while still visualizing the “whole thing.” Symmetry affects only the displayed image, not the data, so you cannot query the image or use the image as a parent Part. However, you can create the same effect by creating dependent Parts with the same symmetry attributes as the parent Part.

You can mirror the Part to more than one quadrant. If the Part occupies more than one quadrant, each portion of the Part mirrors independently. Symmetry works as if the local frame is Rectangular, even if it is cylindrical or spherical. The images are displayed with the same attributes as the Part. For each toggle, the Part is displayed as follows. The default for all toggle buttons is OFF, except for the original representation - which is ON.

Mirror X	quadrant on the other side of the YZ plane.
Mirror Y	quadrant on the other side of the XZ plane.
Mirror Z	quadrant on the other side of the XY plane.
Mirror XY	diagonally opposite quadrant on the same side of the XY plane.
Mirror XZ	diagonally opposite quadrant on the same side of the XZ plane.
Mirror YZ	diagonally opposite quadrant on the same side of the YZ plane.
Mirror XYZ	quadrant diagonally opposite through the origin.
Show Original Instance	the original part instance

Rotational visual symmetry allows for the display of a complete (or portion of a) “pie” from one “slice” or instance. You control this option with:

Axis X	rotates about the X axis
Y	rotates about the Y axis
Z	rotates about the Z axis
Angle	specifies the angle (in degrees) to rotate each instance from the previous
Instances	specifies the number of rotational instances.
Show Original Instance	show the original instance or not

Access: Part Mode : Visual Symmetry Icon

*Element -Node  
Icon*

Opens the Node/Element labelling attributes dialog. Toggles on/off the visibility of the element and/or node labels (assuming the result file contains them) for the selected Part(s). The Global Element Label Toggle (Main Menu>View>Label Visibility) must be on in order to see any element labels. Likewise, the Global Node Label Toggle (Main Menu>View>Label Visibility) must be on in order to see any element labels.



Figure 8-11  
Part Mode - Element/Node Label Toggle Icon

Access: Part Mode : Element/Node Label Toggle Icon

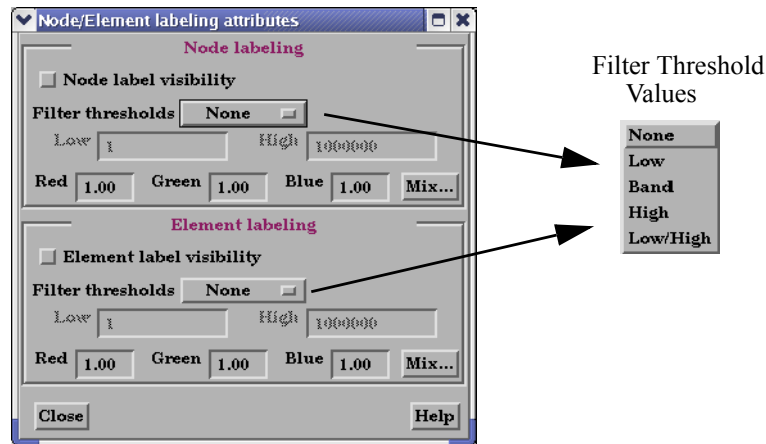

Figure 8-12  
Part Mode - Element/Node Label Toggle Dialog

Access: Part Mode : Node Label Toggle Icon

**Element/Node Label Visibility**

Toggles on/off the visibility of the element or node labels (assuming the result file contains them) for the selected Part(s). Performs the same function as the Label Visibility Node toggle in the Node, Element, and Line Attributes section of the Feature Detail Editor (Model). Default is OFF.

**Filter Thresholds**

A pulldown menu containing the following  
*Low* - All element/node ids below the value in the low field are invisible  
*Band* - All element/node ids between the values in the low and high fields are invisible.  
*High* - All element/node ids above the value in the high field are invisible.  
*Low/High* - All element/node ids below the low and above the high field values are invisible.

**Mix**

Enter the element/node id label color, or click on the Mix Button and pick your color.

**Node Representation Icon**

Opens the Part Node Representation dialog. Performs the same function as the Node Representation area in the Node, Element, and Line Attributes section of the Feature Detail Editor (Model).

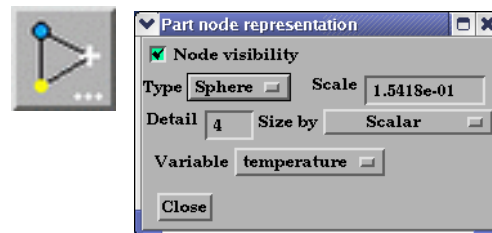

Figure 8-13  
Part Mode - Node Representation Icon and Part Node Representation dialog

Node Visibility Toggle Toggles-on/off display of Part's nodes whenever the Part is visible. Default is OFF.

**Type**

Opens a pop-up menu for the selection of symbol to use when displaying the Part's nodes. Default is Dot. Options are:  
*Dot* to display nodes as one-pixel dots.  
*Cross* to display nodes as three-dimensional crosses whose size you specify.  
*Sphere* to display the nodes as spheres whose size and detail you specify.

Scale	This field is used to specify scaling factor for size of node symbol. If Size By is Constant, this field will specify the size of the marker in model coordinates. If Size By is set to a variable, this field will be multiplied by the variable value. Not applicable when node-symbol Type is Dot.
Detail	This field is used to specify how round to draw the spheres when the node-symbol type is Sphere. Ranges from 2 to 10, with 10 being the most detailed (e.g., roundest spheres). Higher values take longer to draw, slowing performance. Default is 4.
Size By	<p>Opens a pop-up menu for the selection of variable-type to use to size each node-symbol. For options other than Constant, the node-symbol size will vary depending on the value of the selected variable at the node. Not applicable when node-symbol Type is Dot. Default is Constant. Options are:</p> <p><i>Constant</i> sizes node using the Scale factor value.</p> <p><i>Scalar</i> sizes node using a scalar variable.</p> <p><i>Vector Mag</i> sizes node using magnitude of a vector variable.</p> <p><i>Vector X-Comp</i> sizes node using magnitude of X-component of a vector variable.</p> <p><i>Vector Y-Comp</i> sizes node using magnitude of Y-component of a vector variable.</p> <p><i>Vector Z-Comp</i> sizes node using magnitude of Z-component of a vector variable.</p>
Variable	<p>Selection of variable to use to size the nodes. Activated variables of the appropriate Size By type are listed. Not applicable when node-symbol Type is Dot or Size By is Constant.</p> <p style="text-align: center;">Access: Part Mode : Node Representation Icon</p>
<b>Part Failed Element Icon</b>	<p>Opens the Part Failed Element Settings dialog. Choose a <i>per-element scalar</i> variable. This does a deep element removal of the elements from the selected model part on the server based on logical operators on the variable.</p>

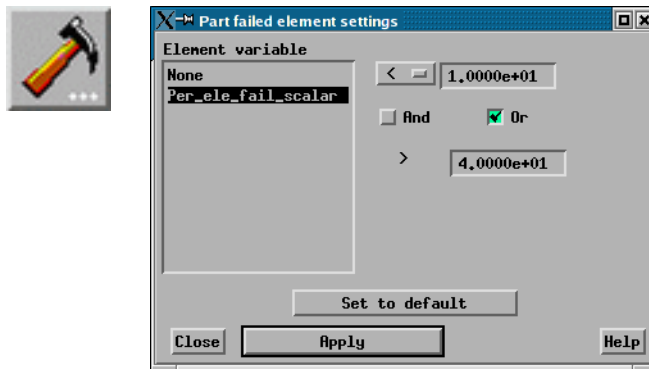

Failure operator	Select a per-element scalar variable. Choose a pulldown threshold (<, >, = or !=).
And / Or	If you toggle on a logical operator then choose second threshold.
Set to default	To set the threshold values back to the default of 0.0.
<b>Part Element Blanking/Selection</b>	<p>Brings up the Part Element Blanking Attributes Dialog. Element blanking is the visual removal of elements on the graphics screen. The elements still remain on the server and are still used in calculations, they are just not visible in the graphics window.</p> <p><a href="#">See How To Remove Failed Elements</a></p>
Element blanking	Toggles on/off whether element blanking allowed
Clear	Clears blanked elements and restores them to visible for the selected Part(s)

Clear all parts

Clears blanked elements and restores them to visible for all Part(s)

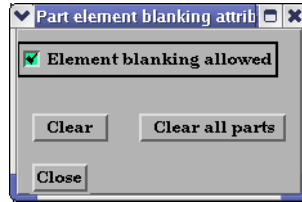

[See How To Do Element Blanking](#)

*Part Shaded  
Toggle Icon*

Toggles on/off Shaded display of surfaces for the selected Part(s) assuming that Global Shaded has been toggled ON in the Main Menu > View > Shaded. Performs the same function as the Shaded Toggle in the General Attributes section of the Feature Detail Editor (Model). Default for all Parts is ON.

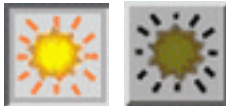

Figure 8-14  
Part Mode - Part Shaded Toggle ON / OFF Icon

Access: Part Mode : Part Shaded Toggle Icon

*Part Hidden Line  
Toggle Icon*

Toggles on/off hidden line display of surfaces for the selected Part(s) assuming that the Global Hidden Line has been toggled ON in the Main Menu > View > Hidden Line. Performs the same function as the Hidden Line Toggle in the General Attributes section of the Feature Detail Editor (Model). Default for all Parts is ON.



Figure 8-15  
Part Mode - Part Hidden Line Toggle ON / OFF Icon

Access: Part Mode : Part Hidden Line Toggle Icon

*Part Auxiliary Clipping  
Toggle Icon*

Toggles on/off whether the selected Part(s) will be affected by the Auxiliary Clipping Plane feature. Performs the same function as the Aux Clip toggle in the General Attributes section of the Feature Detail Editor (Model). Default is ON. Auxiliary clipping is simply a visual clipping that occurs only on the client and does not affect the underlying model geometry, only it's view on the screen.

*Note: The Global Auxiliary Clipping Toggle (in the View Mode Icon Bar) must be on in order for any Parts to be affected by the Aux Clip Plane.*



Figure 8-16  
Part Mode - Part Auxiliary Clipping Toggle ON / OFF Icon

Access: Part Mode : Part Auxiliary Clipping Toggle Icon

**Fast Display  
Toggle Icon**

Opens a pull-down menu for the specification of the desired fast display representation in which a Part is displayed. The Part fast display representation corresponds to whether the view Fast Display Mode (located in the View Menu) is on. The Fast Display pull-down icon performs the same function as the Fast Display pop-up menu button in the General Attributes section of the Feature Detail Editor (of all parts).

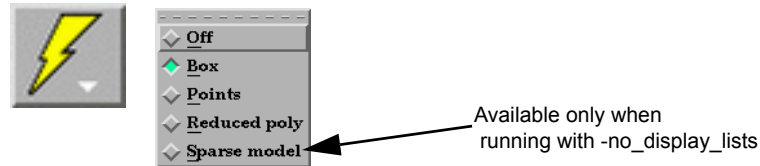

Figure 8-17  
Part Mode - Detail Representation Pulldown Icon

<i>Box</i>	causes selected Part(s) to be represented by a bounding box of the Cartesian extent of all Part elements (default)
<i>Points</i>	causes selected Part(s) to be represented by a point cloud
<i>Reduced poly</i>	causes selected Part(s) to be represented by reduced number of polygons
<i>Sparse Model</i>	decimates part elements by a factor determined in the Preferences (Edit>Preferences>Performance and enter in a factor from 1 (sparse) to 100 (full) in the Sparse Model Field.

(see General Attributes in [Section 3.3, Part Editing, How To Set Global Viewing](#))

Access: Part Mode : Detail Representation Pull-down Icon

## 8.2 Annot Mode

Annot (Annotation) Mode is used to create and edit text strings, lines, and import logos into the Graphics Window., and to adjust their visibility, size, color, and position. It is also used to adjust the type, size, format, and position of legends.

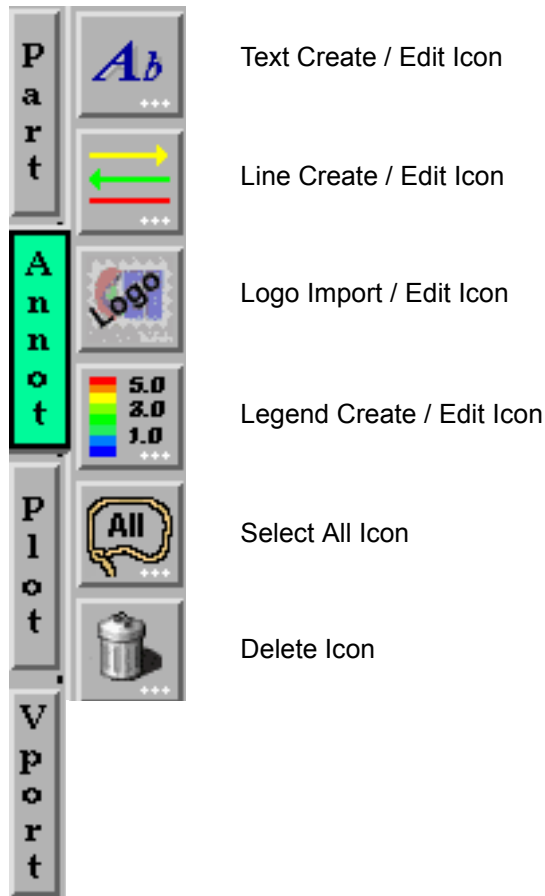

Figure 8-18  
Mode Selection Area - Annot Selected

When in Annot Mode, you are always modifying the objects selected in the Graphics Window. Selected Annotation objects are outlined in the “selection color”, while unselected objects are outlined in a white color. To select an object, click the mouse over it. To select multiple objects, hold the Control key down while clicking on the objects.

Annotation objects, other than text, are positioned in the main Graphics Window; they are not tied to specific viewports.

*Text Create / Edit Icon* Opens the Annotation Creation dialog with the Text tab highlighted.

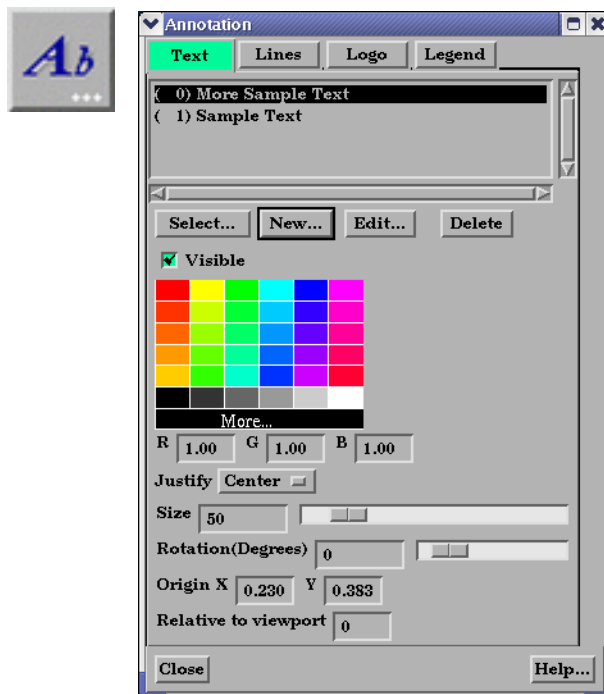

Figure 8-19  
Annot Mode - Text Creation Icon and Text Annotation Creation dialog

Text strings may be created and inserted into the Graphics Window using the Text Annotation dialog. This dialog provides a list of text items.

#### Select

A pulldown that allows text item(s) to be selected. They can also be selected using the mouse in the text menu, or in the graphics window by clicking on them. Select options include any one of the following:

- Select all      Select all text items.
- Select visible      Select text whose visible toggle (located below the Select Button) is on.
- Select invisible      Select text whose visible toggle (located below the Select Button) is off.
- Deselect all      No text items are selected.

New / Edit

Clicking New or Edit button opens the Text Annotation Creation / Editing Dialog allowing the creation or modification of a text item. If Create is toggled ON for the Operating Mode, a new text item will be created and placed in the graphics window when you press Enter on your keyboard. If Edit is toggled ON for the Operating Mode, then the selected text item will be available in the Text Field. The update will occur when you press the Enter on your keyboard.

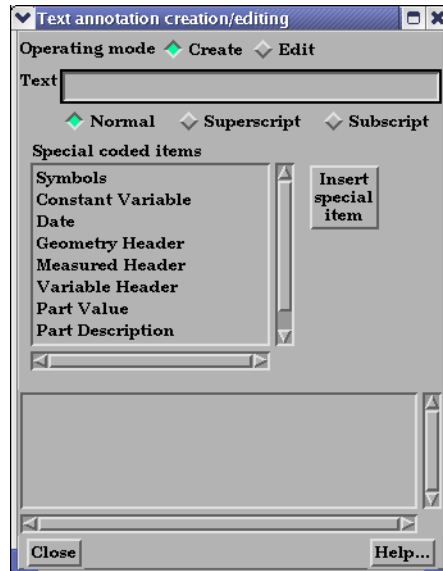

Figure 8-20  
Annot Mode - Text Create Edit dialog

Special Coded Items

Menu of eight different special strings used to insert information contained in results data set or within EnSight into text string.

Insert Special Item

Inserts selected Special String into Text field at position of cursor. Choices are:

- Constant Variable* inserts the value of the constant variable selected and displays it in the selected format
- Date* inserts the Day of Week, Month, Date, Time, Year
- Geometry Header* inserts either the first or second header lines of the geometry file
- Measured Header* inserts the header line of the measured results file
- Variable Header* inserts the header line of the selected variable data file
- Part Value* inserts the value used to create the Isosurface or Clip Plane Part. Only works for Isosurface Parts, or XYZ, IJK, or RTZ Clip Plane Parts)
- Part Description* inserts the description of the Part selected in a Parts List which pops up within the Text Annotation Creation dialog
- Version* inserts the EnSight version number, not including the (letter).  
For example, 8.0.1 (a) would be 8.0.1

Delete

Allows text item(s) to be deleted.

Visible

Toggles Text Visibility ON/OFF.

Mix

Allows control of text color

Justify

Pulldown for Left, Right or Center justification.

Size

Field containing text size

Rotation/Degrees

Field for rotation in degrees (-360 to 360).

Origin

Normalized Coordinates of text, range 0 to 1.

Relative to Viewport

Viewport reference for origin of text.

Access: Annot Mode : Text Creation Icon



*Line Create /Edit Icon* Opens the Annotation Creation dialog with the Line tab selected.

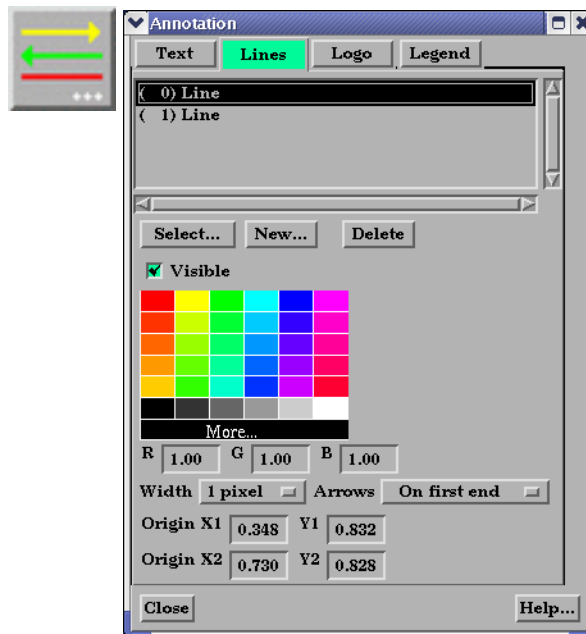

Figure 8-21  
Annot Mode - Line Creation Icon

Select	Allows line(s) to be selected. They can also be selected using the mouse in the text menu, or by clicking on them in the Graphics Window.
New	Clicking New button creates a new line and places it in the graphics window.
Delete	Deletes the selected line(s) and removes the line(s) from the graphics window.
Visible	Toggles Line Visibility ON/OFF.
Mix	Allows control of line color
Width	Controls the line width in pixels.
Arrows	Allows placement of arrow on line.
Origin	Beginning and ending line normalized X and Y coordinates (0 to 1)
<i>Logo Import / Edit Icon</i>	Clicking the Logo Import Icon opens the File Selection dialog for the specification of the file name containing the desired logo. Files must be in xpm format (and cannot use color names - colors must be hex numbers).



Figure 8-22  
Annot Mode - Logo Import Icon

Access: Annot Mode : Logo Import Icon

Select	Allows Logo(s) to be selected. They can also be selected using the mouse in the text menu, or by clicking on them in the Graphics Window.
New	Clicking New button opens a dialog to load a new Logo. Currently EnSight can load .bmp or .xpm graphics files for Logos.
Delete	Deletes the selected Logo(s) and removes the Logo(s) from the graphics window.
Visible	Toggles Logo Visibility ON/OFF.
Origin	Normalized X and Y location
Scale	X and Y scaling

*Legend Create / Edit* Clicking on this icon opens the Annotation

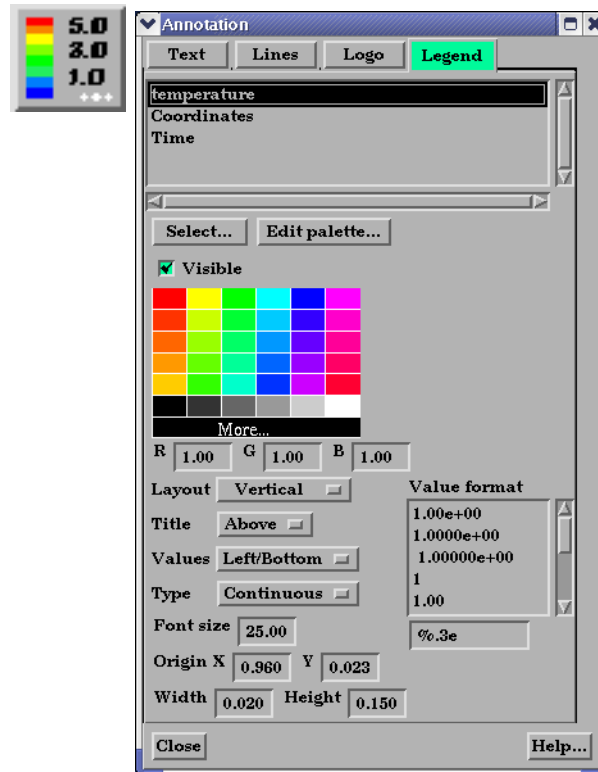

Figure 8-23  
Annot Mode - Legend Create / Edit Icon and Dialog

Select	Allows Logo(s) to be selected. They can also be selected using the mouse in the text menu, or by clicking on them in the Graphics Window.
Edit Palettes	Allows Logo(s) to be selected. They can also be selected using the mouse in the text menu, or by clicking on them in the Graphics Window.
Visible	Toggles Legend Visibility ON/OFF.
More...	Click on a color to change the legend text color, or click on More to create a color yourself.
Layout	Layout of the Legend Bar: Vertical or Horizontal
Title	Location of the Title: Above, Below or None
Values	Location of the legend values: Left/Bottom, Right/Top, or None
Type	Color distribution: Continuous or Discrete
Font Size	Choose a Font Size
Origin	Location of Legend can be typed in precisely, or just drag it in the Graphics Window where you want it located
Width, Height	Type in an exact value, or just grab one of the legend bar highlighted corners and drag it.
Value Format	Choose a format for the legend numbers.

**Select All...**

Brings up the Annotation Selection Options Dialog which allows selection of the various annotation types.

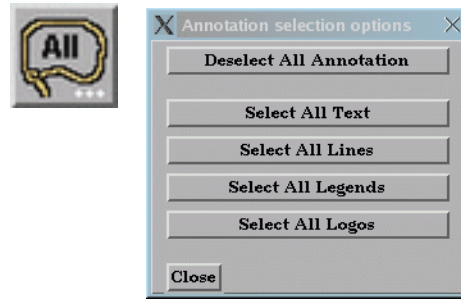

Figure 8-24  
Annot Mode - Select All... Icon and Annotation Selection Options Dialog

**Delete Icon**

Deletes selected text, line or logo Annotation object(s).



Figure 8-25  
Annot Mode - Delete Icon

You cannot delete legends using the Delete Icon. Once a legend for a specific variable has been made visible using the Show Legend button, it can be made non-visible using either the Annot: Visibility Toggle or the Annot: Global Legend Visibility Toggle Icon.

Access: Annot Mode : Delete Icon

**Legend...**

Clicking the Legend... button (located on the Desktop above the graphics window) will allow the user to control which legends are visible.



## 8.3 Plot Mode

Plot Mode is used to adjust the attributes of 2D graphs and curves that you have created. Most often, you will create graphs using the Query/Plot Editor in the Quick Interaction Area, but you can create a new “empty” graph using the Create New Plotter Icon and then assign a title and data to its axes using the Query/Plot Editor in the Quick Interaction Area

In Plot Mode, there are two things you can select.

1. You can click the plot window and the whole plot window will have a highlighted box indicating its selection (green in color by default).
2. You can click on an individual curve to cause the curve line to thicken - indicating selection.

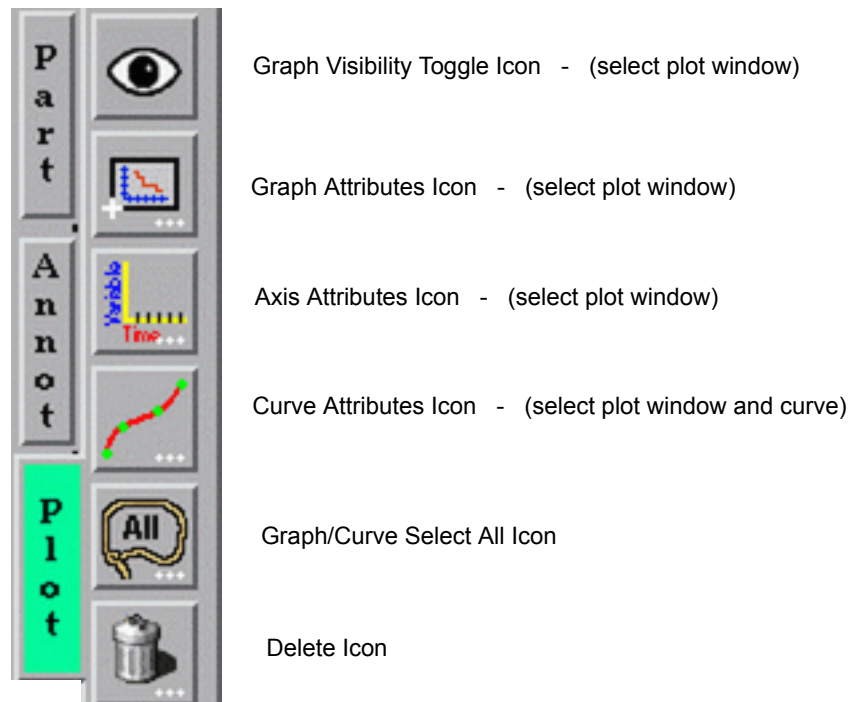

Figure 8-26  
Mode Selection Area - Plot Selected

The plotting capability is limited to simple x versus y data. Most often this data is in the form variable value versus Time or Distance.

*Graph Visibility Toggle Icon*

Determines the visibility of the selected plotters. The selected plotters for which visibility has been toggled off will appear grayed-out in Plot Mode.



Figure 8-27  
Plot Mode - Plotter Visibility Toggle Icon

Access: Plot Mode : Plotter Visibility Toggle Icon

*Graph Attributes Icon* Opens the Plotter Specific Attributes dialog for the specification of attributes for Title, background, legend, border and position of the selected plotters.



Figure 8-28  
Plot Mode - Plotter Attributes Icon and Plotter Specific Attributes dialog

Clicking the Background tab causes the dialog to configure itself for Plotter Background editing

Background

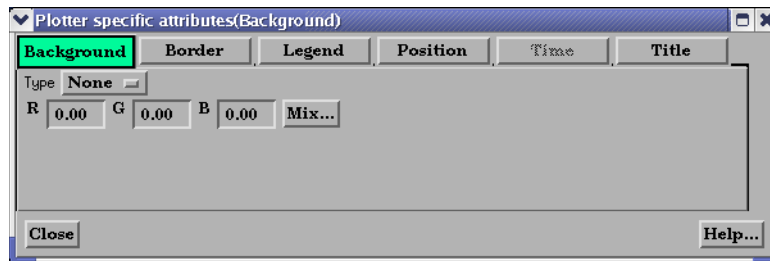

Type

Opens a pop-up menu for the specification of plotter background color. Choices are:  
*None* no background (the color of the Graphics Window or the viewport underneath will show through the Plotter)

*Solid* allows a solid color to be specified for the Plotter Background

RGB Mix...

Color for the Plotter background may be specified using either the RGB fields or the Color Selector dialog which is opened by clicking the Mix... button.

Border

Clicking the Border tab causes the dialog to configure itself for Plotter Border editing



Visible Toggle

Toggles on/off the visibility in the other five Modes of the Border for the selected Plotters.

RGB Mix...

Color for the plotter border may be specified using either the RGB fields or the Color Selector dialog which is opened by clicking the Mix... button. Note that the border color is not shown while the plotter is selected - while selected the border is shown in green.

See [Part Color](#), [Lighting](#), [Transparency](#)

Legend

Clicking the Legend tab causes the dialog to configure itself for Plotter Legend editing. The legend shows a line of the appropriate color, width, and marker next to the name of the curve plotted using this line style.

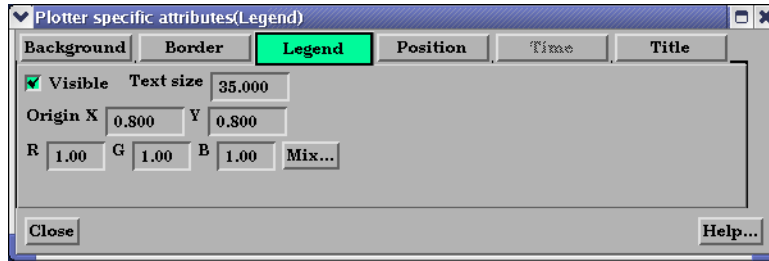

Visible Toggle

Toggles on/off the visibility of the legend for the selected Plotters.

Text Size

This field specifies the desired size of the Legend text.

Origin X Y

These fields specify the location of the Legend within a Plotter's border. Values range from 0.0 to 1.0 and resulting distances are measured from the Border origin (lower left corner). These fields provide an alternative to interactively positioning the plotter Legend.

RGB Mix...

Color for the Legend text may be specified using either the RGB fields or the Color Selector dialog which is opened by clicking the Mix... button.

Position

Clicking the Position tab causes the dialog to configure itself for Plotter Position.

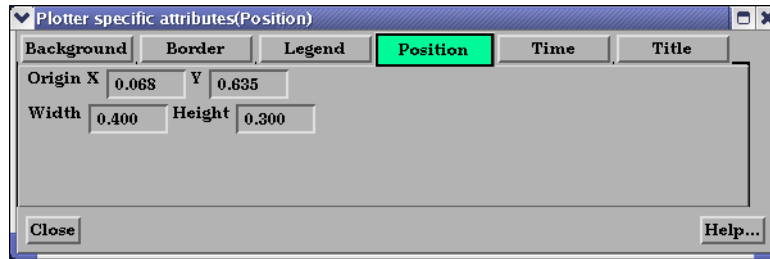

Origin X Y

These fields specify the location of the selected Plotter within the Graphics Window. Values range from 0.0 to 1.0 and resulting distances are measured from the Graphics Window origin (lower left corner). These fields provide an alternative to interactively positioning the plotter which is done simply by clicking within the Plotter and dragging it to the desired position.

Width, Height

These fields specify the width and height of the Plotter. Resulting distances are measured from the Border origin (lower left corner). These fields provide an alternative to interactively resizing the plotter which is done simply by clicking on a side or corner and dragging.

Time

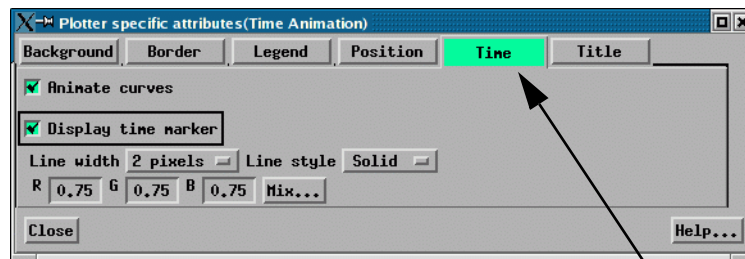

This tab is enabled only for plots with transient data.

- Animate Curve When the solution time is changed or streamed (data loaded from disk one step after another) or loaded in the flipbook, toggling this ON will cause the transient curve to plot the data timestep by timestep.
- Display Time Marker The Time Marker is a vertical time indicator line that appears only on a transient plot. When the solution time is changed or streamed (data loaded from disk one step after another) or loaded in the flipbook, toggling this ON will cause the vertical line Time Marker to indicate the current timestep value on the plot.
- Line Width Set the line width of the vertical time indicator line on the transient plot.
- Line Style Set the line style of the vertical time indicator line on the transient plot.
- RGB Set the color (RGB values) of the vertical time indicator line on the transient plot.

Access: Plot Mode : Plotter Attributes Icon

Title



Clicking the Title tab causes the dialog to configure itself for Graph Title editing.

- Title This field allows you to edit the existing plotter title.
- Insert Symbol This button brings up a matrix of symbols to pick from to allow you to insert symbols into the plotter title.
- Size This field allows you to specify the title text size.
- RGB Mix... Color for the Title text may be specified using either the RBG fields or the Color Selector dialog which is opened by clicking the Mix... button.

Axis Attributes Icon

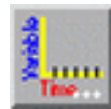

Opens the Axis Specific Attributes dialog for the specification of attributes for axes of the selected Plotters.

Figure 8-29  
Plot Mode - Axis Attributes Icon and Axis Specific Attributes dialog

General

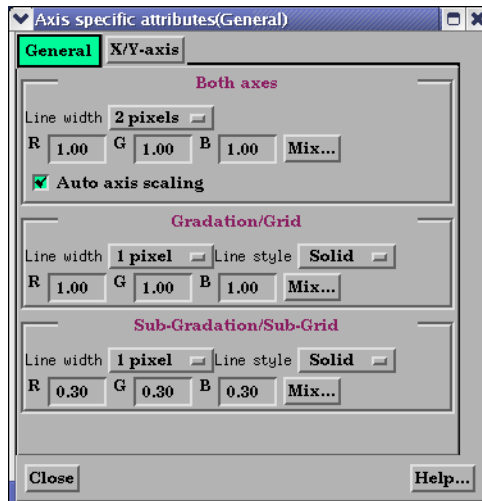

Clicking the General tab causes the dialog to configure itself for General Plotter Axis editing.

## Both Axes

**Line Width** Opens a pop-up menu for the specification of the desired line width (1 to 4 Pixels) for Plotter axes.

**RGB Mix...** Color for the axes may be specified using either the RBG fields or the Color Selector dialog which is opened by clicking the Mix... button

**Auto Axis Scaling Toggle** When toggled on, the axis range and number of divisions will be scaled to make nice “round” numbers.

## Gradation/Grid

**Line Width** Opens a pop-up menu for the specification of the desired width (1-4 Pixels) for Gradation Lines or Ticks.

**Line Style** Opens a pop-up menu for the specification of the style of line (Solid, Dotted, or Dashed) desired for gradations. (The lines are normally not visible and so this specification is only valid if Grad Type has been selected to Grid in the X-Axis and/or Y-Axis configuration of the Axis Specific Attributes dialog.)

**RGB Mix...** Color for the Gradation Lines or Ticks may be specified using either the RBG fields or the Color Selector dialog which is opened by clicking the Mix... button.

## Sub-Gradation/Sub-Grid

**Line Width** Opens a pop-up menu for the specification of the desired line width (1-4 Pixels) for Sub-Gradation Lines or Ticks (those between the Gradation Lines or Ticks).

**Line Style** Opens a pop-up menu for the specification of the style of line (Solid, Dotted, or Dashed) desired for sub-gradations. (The lines are normally not visible and so this specification is only valid if SubG Type has been selected to Grid in the X-Axis and/or Y-Axis configuration of the Axis Specific Attributes dialog.)

**RGB Mix...** Color for the Sub-Gradation Lines or Ticks may be specified using either the RBG fields or the Color Selector dialog which is opened by clicking the Mix... button.

## X-Axis or Y-Axis

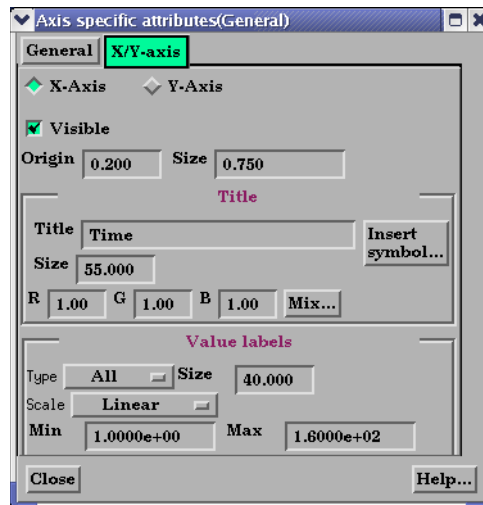

Clicking the X-Y Axis tab causes the dialog to configure itself for editing of Attributes specific to either the X or the Y Axis. If X-Axis toggle has been clicked, the dialog will affect the X-Axis attributes only. Likewise for Y-Axis.

**Visible Toggle** Toggles on/off the visibility of the X (or Y) Axis line.

**Origin** This field specifies the location of the X (or Y) Axis origin. Values range from 0.0 to 1.0 and resulting distances are measured from the left side (or bottom) of the Plotter.

**Size** This field specifies the length of the X (or Y) Axis line. Values range from 0.0 to 1.0 and resulting distances are measured from the X (or Y) Axis Origin.



Title	
Title	This field allows you to edit the existing X (or Y) Axis title.
Size	This field allows you to specify the title text size.
RGB Mix...	Color for the Title text may be specified using either the RBG fields or the Color Selector dialog which is opened by clicking the Mix... button.
Value Labels	
Type	Opens a pop-up menu for selection of desired number (None, All, or Beg/End) of X (or Y) Axis labels.
Size	This field allows you to specify the size of X (or Y) Axis labels.
Scale	This field allows you to specify a linear or log10 scale for the Axis.
Min	This field contains the minimum value of the X (or Y) Axis. If Auto Axis Scaling is on, it is only an approximation to the value which will be used.
Max	This field contains the maximum value of the X (or Y) Axis. If Auto Axis Scaling is on, it is only an approximation to the value which will be used.
Format	This field specifies the format used to display the X (or Y) Axis. Any C language <i>printf</i> format is valid in this field.
Format...	This button will open the Format dialog which allows you to select a pre-defined format.
Gradation/Sub-Grad	
Grad Type	Opens a pop-up menu for selection of desired marker (None, Grid, or Tick) for major gradations.
# of	# of field specifies the number of major gradations you wish along the X (or Y) Axis. If Auto Axis Scaling is on, it is only an approximation to the value which will be used.
SubG Type	Opens a pop-up menu for selection of desired marker (None, Grid, or Tick) for sub gradations (between the major gradations.
# of	# of field specifies the number of sub gradations you wish between each major gradation along the X (or Y) Axis.

Access: Plot Mode : Axis Attributes Icon

**Curve Attributes Icon** Opens the Curve Specific Attributes dialog for the specification of attributes for an individual curve which has been selected in a Plotter. A curve is selected by clicking the mouse cursor on top of the curve. The selected curve will be drawn by a wider line than is normally used to display the curve.

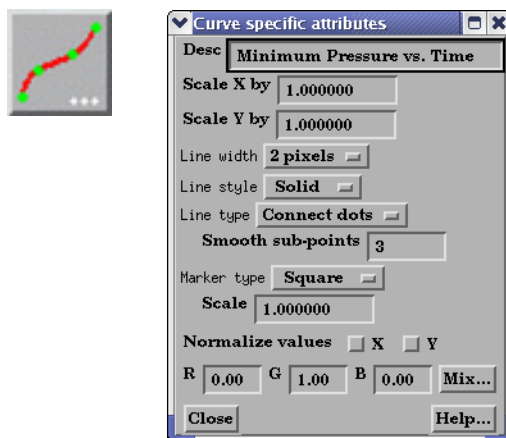

Figure 8-30  
Plot Mode - Curve Attributes Icon and Curve Specific Attributes dialog

**Desc.** This field initially contains the Legend description of the selected Curve which was assigned to it when the Curve was created. Edit and press Return to change the description.

## 8.3 Plot Mode

Scale X/Y By	Scales the respective X or Y values by the specified factor.
Line Width	Opens a pop-up menu for the specification of the desired line width (1-4 Pixels) for the selected Curve.
Line Style	Opens a pop-up menu for the specification of the style of line (Solid, Dotted, or Dashed) desired for the selected Curve.
Line Type	Opens a pop-up menu for the specification of the type of line desired for the selected Curve. Options are: <i>None</i> No lines will be drawn between points <i>Connect Dot</i> Lines will be drawn between the points <i>Smooth</i> A piece wise spline will connect the points
Smooth Sub-points	This field specifies the number of sub-points to use between data points in drawing the curve when Smooth Line Type is selected.
Marker Type	Opens a pop-up menu for the specification of the desired type of data point marker (None, Dot, Circle, Triangle, Square) on the curve.
Scale	This field specifies the size of the data point markers for the selected curve.
RGB Mix...	Color for the selected Curve may be specified using either the RBG fields or the Color Selector dialog which is opened by clicking the Mix... button

Access: Plot Mode : Curve Attributes Icon

**Select All...** Brings up the Plot Selection Option Dialog which allows selection of all curves or all plotters.

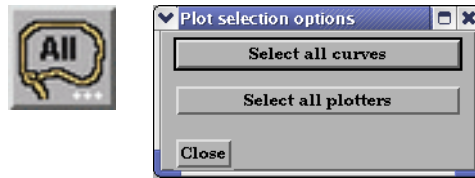

Figure 8-31  
Plot Mode - Select All... Icon and Plot Selection Options Dialog

**Delete Icon** Deletes the selected Plotters.



Figure 8-32  
Plot Mode - Delete Icon

Access: Plot Mode : Delete Icon

## 8.4 VPort Mode

VPort Mode is used to create, adjust the attributes of, and delete viewports.

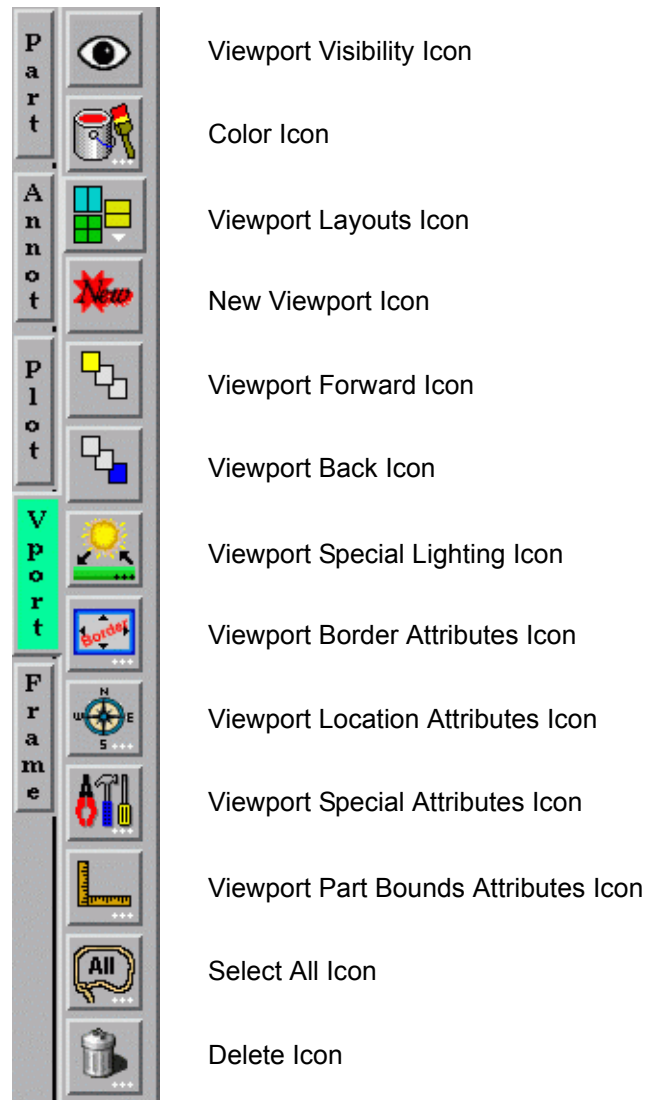

Figure 8-33  
Mode Selection Area - VPort Selected

The default EnSight configuration shows one view of your model in the “main” Graphics Window. This “initial viewport”, which covers the Graphics Window, cannot be removed and is always used to clear (erase) the Graphics Window prior to a redraw. Using the VPort Mode, you can create up to fifteen additional viewports that will overlay the Graphics Window. These viewports can be interactively resized and relocated within the Graphics Window using the mouse and the visibility of each Part can be controlled on a per viewport basis. Transformations, and Z-clip location settings can also be made independently in each viewport.

When in VPort Mode, you are always modifying the viewports selected in the Graphics Window. Selected viewports are outlined in the “selection color”, while unselected objects are outlined in a white color. To select a viewport, click the mouse over it. To select multiple viewports, hold the Control key down while clicking on them.

Multiple viewports are helpful in showing the same object from multiple views, showing different axes in each viewport, showing the same parts with different attributes, etc.

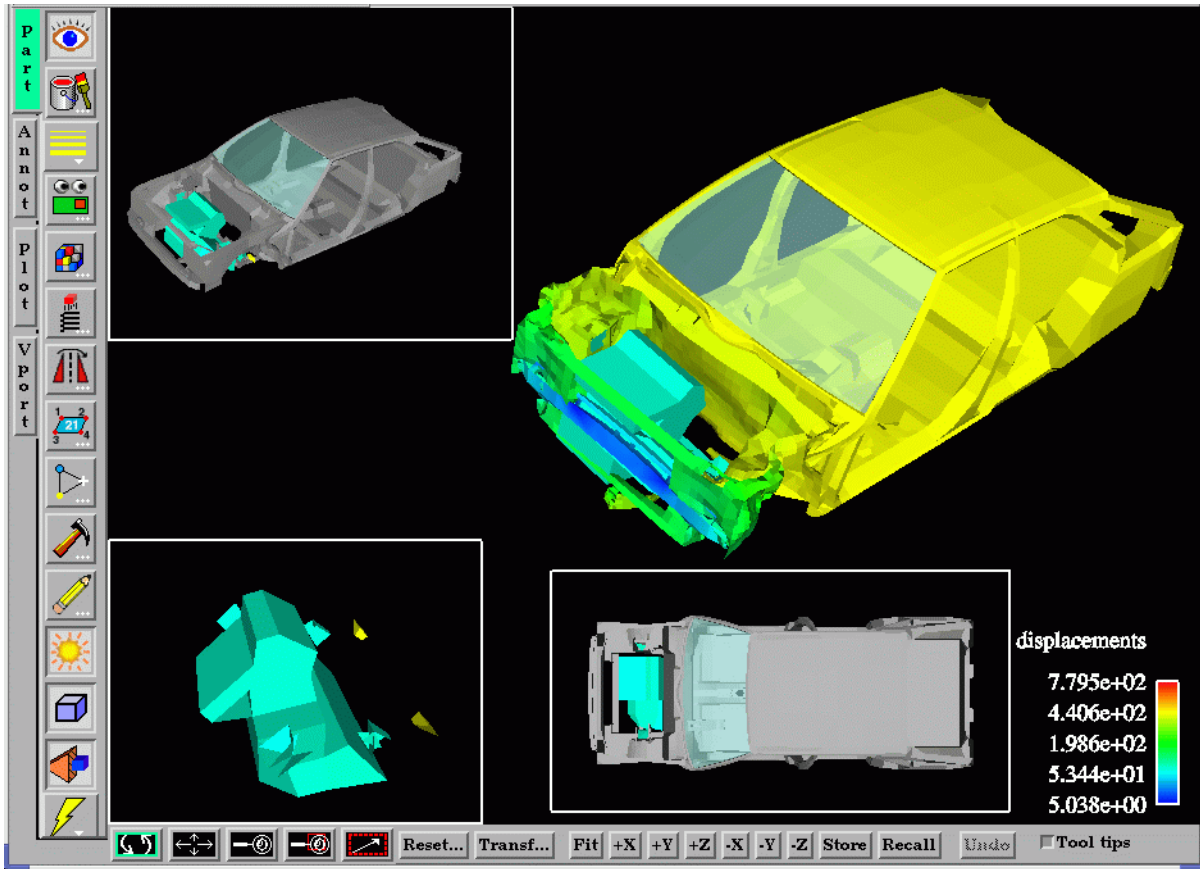

Figure 8-34  
Viewport Example

**Viewport Visibility  
Toggle Icon**

Determines the visibility of the selected viewport(s). The border of a viewport which, in the VPort Mode, has its visibility toggled off will still be visible in the VPort Mode only - and then as a dotted rather than a solid line.



Figure 8-35  
VPort Mode - Viewport Visibility Toggle Icon ON / OFF

Access: VPort Mode : Viewport Visibility Toggle Icon

**Color Icon**

Opens the Viewport Background Color Attributes dialog for the specification of the color you wish to assign to the background of the selected viewport(s).

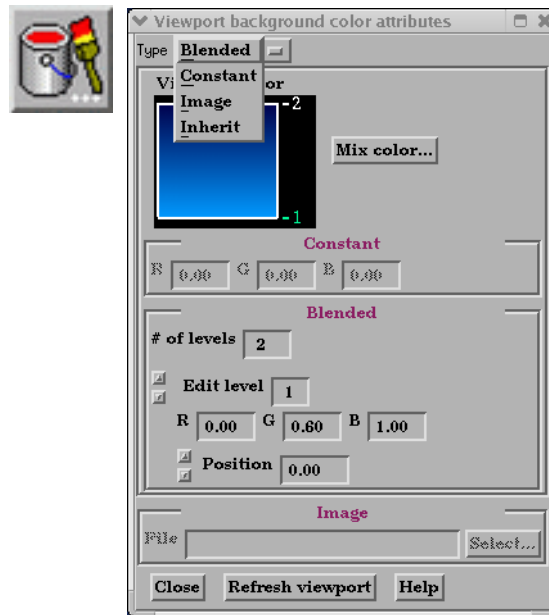

Figure 8-36  
VPort Mode - Color Icon

**Type**

Opens a pull-down menu for the specification of the type of background you wish to assign to a viewport.

<b>Blended</b>	Allows you to specify a background comprised of 2 to 5 blended colors.
<b># of Levels</b>	This field specifies the number of levels (from 2 to 5) at which a color will be specified. The default is 2.
<b>Edit Level</b>	This field specifies which of the levels you wish to edit. You may select the desired level using the stepper buttons, by entering a value in the field, or interactively by clicking on its number on the right side of the Viewport Color window.
<b>Position</b>	This field specifies the vertical position of the edit level as a fraction (from 0 to 1) of the vertical height of the Viewport Color window, where 0.0 is at the bottom and 1.0 is at the top. You may adjust a level to the desired position using the stepper buttons, by entering a value in the field, or interactively by selecting and dragging a level's number on the right side of the Viewport Color window. The position of any level can not be below the position of the next lower level.
<b>Constant</b>	Allows you to specify a constant color using the RGB fields or the Color Selector dialog which is accessed by clicking the Mix Color... button.
<b>Image</b>	Allows you to choose a .bmp or .xpm image as a background for your viewport.
<b>Inherit</b>	Causes the viewport to display the same background color attributes as the main Graphics Window. Only applicable for created viewports, not the main Graphics Window.
<b>Mix Color...</b>	Opens the Color Selector dialog. (See Section 8.1, Color Selector)
<b>Refresh Viewport</b>	Will redraw the selected viewport(s) with the defined viewport background settings. Access: VPort Mode : Color Icon

*Viewport Layouts Icon* This icon opens a pull-down menu of icons which indicate standard viewport layouts.

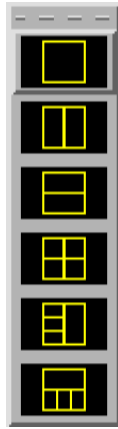

Figure 8-37  
VPort Mode - Viewport Layouts Icon and Menu

Access: Vport Mode : Viewport Layouts Icon

*New Viewport Icon* Clicking this button creates a new Viewport within (and on top of) the “main” Graphics Window. The location and size of the viewport can be modified interactively in the Graphics Window by a) clicking and dragging within the viewport to move it of b) clicking and dragging the edge or corner to resize it. More precise modifications may be performed using the Location... Icon.



Figure 8-38  
VPort Mode - New Viewport Icon

Access: VPort Mode : New Viewport Icon

*Viewport Forward Icon* Clicking this button moves the selected viewport(s) “forward” in the Graphics Window to occlude any viewports which it (they) may overlap. Viewport 0 cannot be “popped”.



Figure 8-39  
VPort Mode -Viewport Forward Icon

Access: VPort Mode : Viewport Forward Icon

*Viewport Back Icon* Clicking this button moves the selected viewport(s) “back” in the Graphics Window to be occluded by any viewports which may overlap it (them). Viewport 0 cannot be “pushed”.



Figure 8-40  
VPort Mode - Viewport Back Icon

Access: VPort Mode : Viewport Back Icon

*Lighting*

Opens the Viewport Lighting Attributes Dialog.

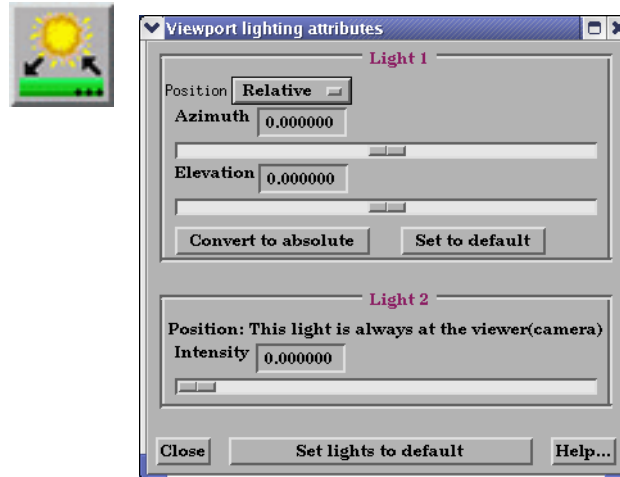

Figure 8-41

VPort Mode - Viewport Border Attributes Icon and Viewport Border Attributes dialog

Position	Position of Light source 1 is either absolute or relative to the camera position.
Azimuth	Azimuth Angle of Light source 1 (-180 to +180 degrees).
Elevation	Elevation of Light source 1 (-90 to +90 degrees).
Convert to Absolute	Converts a relative Azimuth and Elevation angle to Absolute Coordinates.
Set to Default	Restores Light Source 1 values back to default.
Intensity	Intensity of Light source 2 (0 to 1).

Access: VPort Mode : Viewport Lighting Attributes Icon

*Viewport Border Attributes Icon*

Opens the Viewport Border Attributes dialog for the specification of a constant color for the border of the selected viewports. Be aware that the color assigned will only be visible in the other five Modes, not in VPort mode.

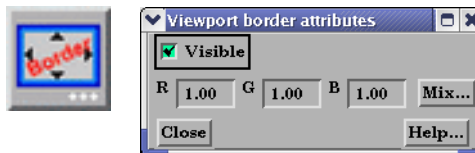

Figure 8-42

VPort Mode - Viewport Border Attributes Icon and Viewport Border Attributes dialog

Visible Toggle	Toggles on/off visibility of a viewport's border in the other five Modes. The border of each viewport will always be visible in VPort Mode.
RGB	These fields specify the RGB values for the color you wish to assign.
Mix...	Opens the Color Selector dialog. See Section 7.1 Color

Access: VPort Mode : Viewport Border Attributes Icon

*Viewport Location Attributes Icon*

Opens the Viewport Location Attributes dialog for the specification of the desired location in the main Graphics Window for the selected viewports. This dialog provides a more precise alternative to moving and resizing the viewports interactively.

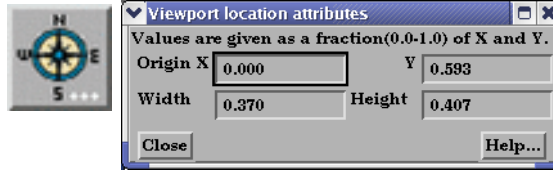

Figure 8-43  
VPort Mode - Viewport Location Attributes Icon and Viewport Location Attributes dialog

Origin X Y

These fields specify the location for the X and Y coordinates of the selected viewport's origin (lower left corner) in the main Graphics Window. Values range from 0.0 to 1.0.

Width, Height

These fields specify the width and height of a selected viewport in X and Y coordinates from the viewport's origin. Values range from 0.0 to 1.0.

Access: VPort Mode : Viewport Location Attributes Icon

*Viewport Special Attributes Icon*

Opens the Viewport Special Attributes dialog for the specification of whether the global settings for Perspective versus Orthographic display, hidden surface display, and hidden line display will apply in the selected viewport(s). In addition, a viewport can be designated as 2D, in which case only planar 2D parts can be displayed in the viewport

*Note, Once you designate a viewport as a 2D viewport, all 3D parts are no longer visible in that viewport. To see the 3D parts in that viewport again, you will need to make the viewport 3D, select the 3D parts in the parts list, and make them visible again using the visibility per viewport icon.*

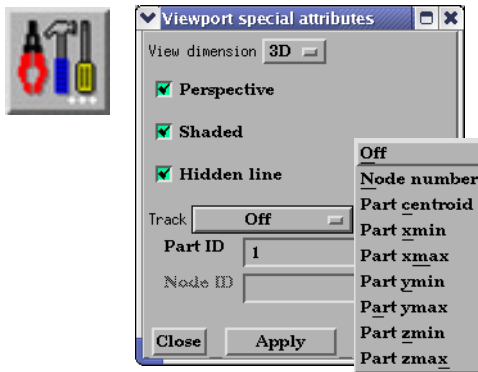

Figure 8-44  
VPort Mode - Viewport Special Attributes Icon and Viewport Special Attributes dialog

Track

Will do a global translate of the geometry to track the motion with respect to one of the following:

Node number - Enter the node id in the Node ID field

Part Centroid - The geometric centroid of the part is used for tracking

Part xmin - The minimum x coordinate of the part is used for tracking.

Part xmax - The maximum x coordinate of the part is used for tracking

Part ymin - The minimum y coordinate of the part is used for tracking

Part ymax - The maximum y coordinate of the part is used for tracking

Part zmin - The minimum z coordinate of the part is used for tracking

Part zmax - The maximum z coordinate of the part is used for tracking

Part ID

ID number of Part used for camera tracking



Node ID Node ID for the Part ID used for tracking if Node number selected in Track pulldown.

Access: VPort Mode : Viewport Special Attributes Icon

### Part Bounds Attributes

Opens the Viewport Bounds Attributes dialog for the specification of part bounding box gradation and labeling.

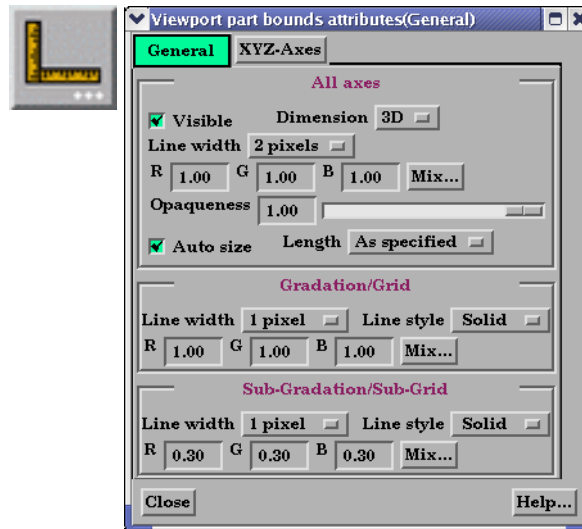

Figure 8-45  
VPort Mode - Viewport Part Bounds Icon and Viewport 2D/3D Grid Attributes (General) dialog

General

Change the dialog to reflect overall extent grid attributes.

XYZ-Axis

Change the dialog to reflect XY or Z-Axis extent attributes (see below).

### All Axes Section

Contains parameters that affect attributes of all axes of the bounding extent.

Visible Toggle

Toggles on/off visibility of the viewport 2D/3D extent axes.

Dimension

Opens a menu for the specification of the desired dimension (2D or 3D) of the bounding extent axis. Default is 3D. 2D is only available for 2D viewports and 3D viewports in orthographic mode.

Line Width

Opens a menu for the specification of the desired line width (1 - 4 pixels) of the bounding extent axis. Default is 2.

RGB

These fields specify the RGB values for the color you wish to assign.

Mix Color...

Opens the Color Selector dialog. See [Part Color, Lighting, Transparency](#)

Transparency

Specifies the degree of opaqueness for the axes of the bounding extent. This value may be adjusted by typing in a value from 0.0 to 1.0 in the field or by using the slider bar whose current value is reflected in the field. A value of 0. will render the axes completely transparent or completely opaque, respectively.

Auto Size Toggle

Toggles on/off the scaling of the axis range to nice “round” numbers.

Length

Opens a menu for the specification of the desired type of length gradation on the axes of the bounding extent.

*As Specified*

Divides the gradations evenly along the length of the axis. (default)

*Rounded*

Tries to round to the units of the common order of magnitude.

### Gradation/Grid Section

Controls the specification of the gradation/grid of the axes of the bounding extent.

Line Width

Opens a menu for the specification of the desired line width (1 - 4 pixels) for the gradation and grid of the bounding extent axis. Default is 1.

Line Style	Opens a menu for the specification of the style of line (Solid, Dotted, or Dashed) desired for the gradation and grid of the bounding extent axis. Default is Solid.
RGB	These fields specify the RGB values for the color you wish to assign.
Mix Color...	Opens the Color Selector dialog. See <a href="#">Part Color</a> , <a href="#">Lighting</a> , <a href="#">Transparency</a>
<b>Sub-Gradation/ Sub-Grid Section</b>	Controls the specification of the subgradation/subgrid of the axes of the bounding extent.
Line Width	Opens a menu for the specification of the desired line width (1 - 4 pixels) for the subgradation and subgrid of the bounding extent axis. Default is 1.
Line Style	Opens a menu for the specification of the style of line (Solid, Dotted, or Dashed) desired for the subgradation and subgrid of the bounding extent axis. Default is Solid.
RGB	These fields specify the RGB values for the color you wish to assign.
Mix Color...	Opens the Color Selector dialog. See <a href="#">Part Color</a> , <a href="#">Lighting</a> , <a href="#">Transparency</a>

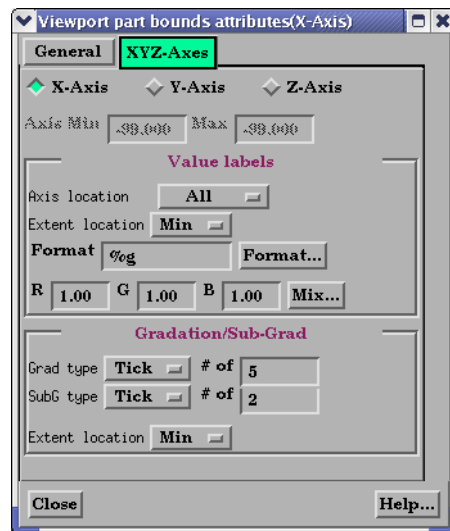

Figure 8-46  
Viewports 2D/3D Grid Attributes (X-Axis or Y-Axis or Z-Axis dialog)

X-, Y-, Z-Axis	These toggles choose the axis.
Axis	These fields reflect the Min and Max values of the selected axis.
<b>Value Labels Section</b>	Controls attributes of the selected axis.
Axis Location	Opens a menu for the specification of the desired location (None, All (default), or Beg/End) to place the labels of the selected axis.
Extent Location	Opens a menu for the specification of the desired extent (Min (default), Max, or Both) on which to display the labels of the selected axis.
Format	This field specifies the format used to display the labels of the selected axis. Any C language “printf” format is valid in this field.

**Format...** Opens the Viewport Axis Text Format dialog which allows you to select a pre-defined format.

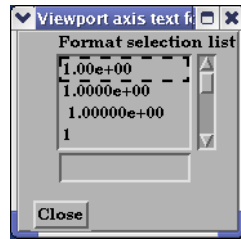

Figure 8-47  
Viewport Axis Text Format dialog

**Format Selection List** List of pre-defined formats. You can also enter any legal C language format string for floating point numbers.

**Format Selection Field** The format specification.

**RGB** These fields specify the RGB values for the color you wish to assign.

**Mix Color...** Opens the Color Selector dialog. See [Part Color](#), [Lighting](#), [Transparency](#)

#### Gradation/Sub-Grad Section

**Grad Type** Opens a menu for the selection of desired marker (None, Grid, or Tick (default)) for major gradations of the selected axis.

**# of** Specifies the number of major gradations you wish along the selected axis. If Auto Size is on, it is only an approximation to the value which will be used.

**SubG Type** Opens a menu for the selection of desired marker (None, Grid, or Tick (default)) for sub-gradations (between the major gradations) along the selected axis.

**# of** Specifies the number of sub-gradations you wish between each major gradation along the selected extent axis.

**Extent Location** Opens a menu for the specification of the desired extent (Min (default), Max, or Both) on which to display the gradation/sub-gradations of the selected axis.

Access: VPort Mode : Viewport Part Bounds Attributes Icon

**Select All** Selects all of the currently defined viewports.



Figure 8-48  
VPort Mode - Select All Icon

**Delete Icon** Deletes individual, selected viewports. (You cannot delete viewport 0).



Figure 8-49  
VPort Mode - Delete Icon

Access: VPort Mode : Delete Icon

## 8.5 Frame Mode

As EnSight reads in model Parts, they are all initially assigned to the same “Frame” of reference: Frame 0. Frame 0 corresponds to the model coordinate system (defined when the model was created). Using the Frame Mode, you can create additional frames, reassign Parts to different Frames, and specify various attributes of the Frames.

Transformations you make in View or Parts Mode (rotations, translations, etc.) are performed globally; all Frames, Parts, and Tools are transformed with respect to the Global Axis origin and orientation. Frame Mode, on the other hand, allows you to perform transformations only on selected Parts. This is useful if you wish, for example, to create an animation with Parts moving in different directions (such as a door or hood opening to reveal Parts within) or to move Part copies away from each other in order to color the Parts by different variables (in fact, if you make a copy of a Part, a new Frame is automatically created and the Part copy is assigned to it).

In Frame Mode, transformations are always about the selected Frame’s definition, that is, its origin position (with respect to Frame 0) and the orientation of its axes (with respect to Frame 0). Since this is the case, the Frame’s orientation must be adjusted (if necessary) before any transformations are applied. If transformations are applied first, and the Frame’s definition adjusted at a later time, the transformations will likely cause unexpected results (since the transformations originally performed were about a different axis definition than that about which transformations performed after the Frames definition changed occur). The necessary order is 1) define frame location and orientation, 2) assign part to frame, 3) perform transformations relative to the frame.

A Part can be assigned to only one Frame at a time. The Part will always be transformed by the Frame’s transformation. A Part is not affected by a Frame’s definition (other than transformations will be in reference to the definition). A Part’s mirror symmetry operation (which can be thought of as a scaling transformation) is always about the Frame to which the Part is assigned.

The Tools (Cursor, Line, Plane, etc.) are always shown in reference to the selected Frame and are thus also transformed by the selected Frame’s transformations.

There are two transformation alternatives in Frame Mode: Frame Transform (the default) and Frame Definition. As pointed out earlier, a frame should first be defined (if necessary) before it is transformed.

In Frame Mode the axis triads for all Frames will be visible in the Graphics Window. Invisible Frames will be shown with a dotted frame axis. Selected Frames are shown in green. A Frame may be selected by clicking on its axis triad or by selecting its description from the Frame List in the Transformation Editor dialog (which is opened by clicking the Transf Edit... button in the Transformation Control Area).

By default, Frame mode is not available unless it has been enabled under Edit > Preferences... General User Interface - Frame Mode Allowed.

For further discussion concerning the transformation of Frames:

(see [Section 9.3, Frame Transform](#) and [Section 9.2, Frame Definition](#))

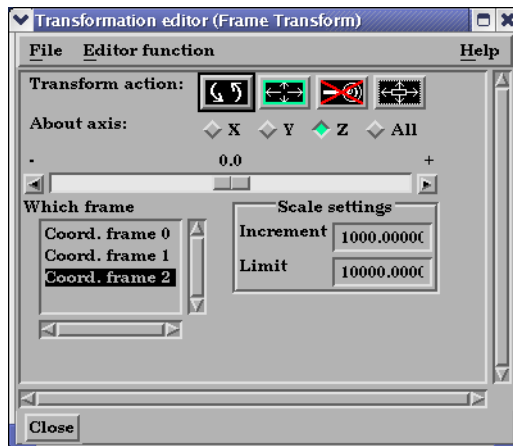
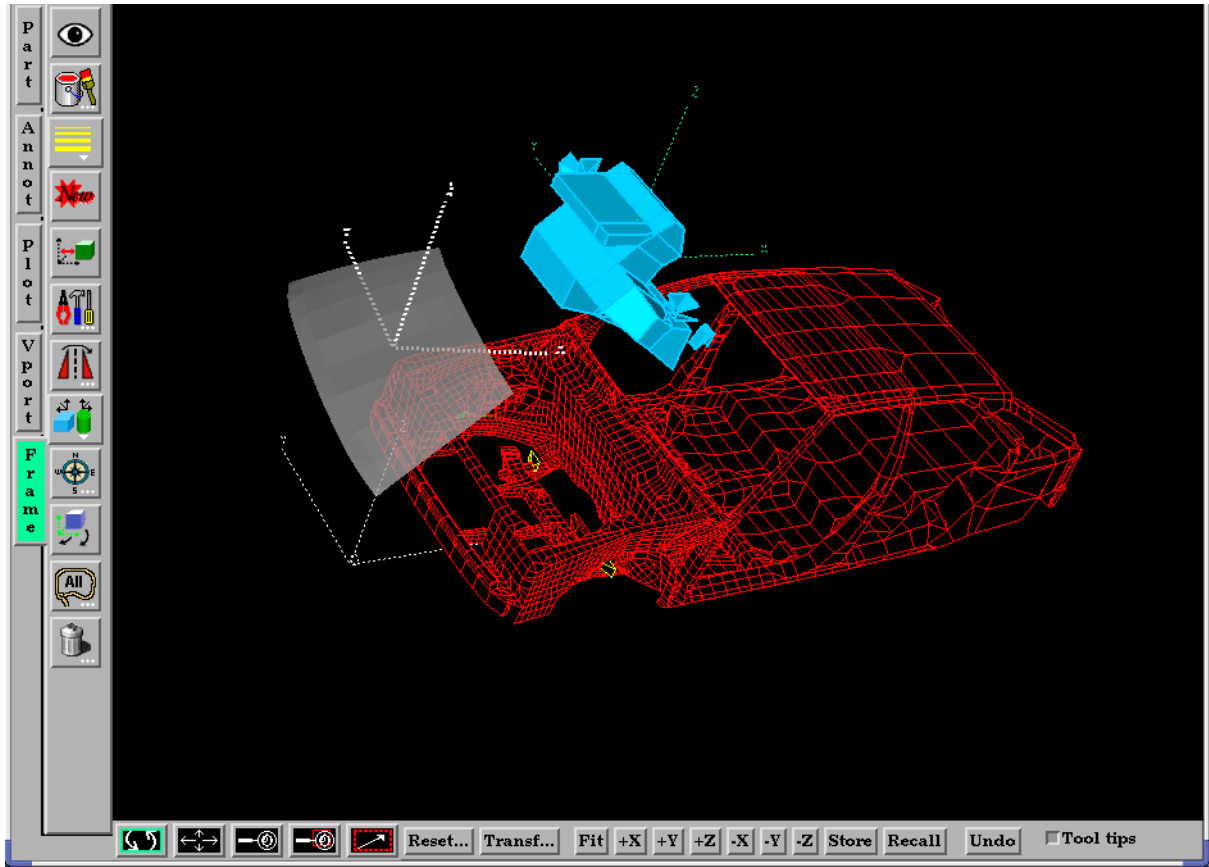

Three Frames exist in this example.

Figure 8-50  
Frame Mode - Frame Example

When Frame Mode is selected, the Mode Icon Bar appears as follows.:

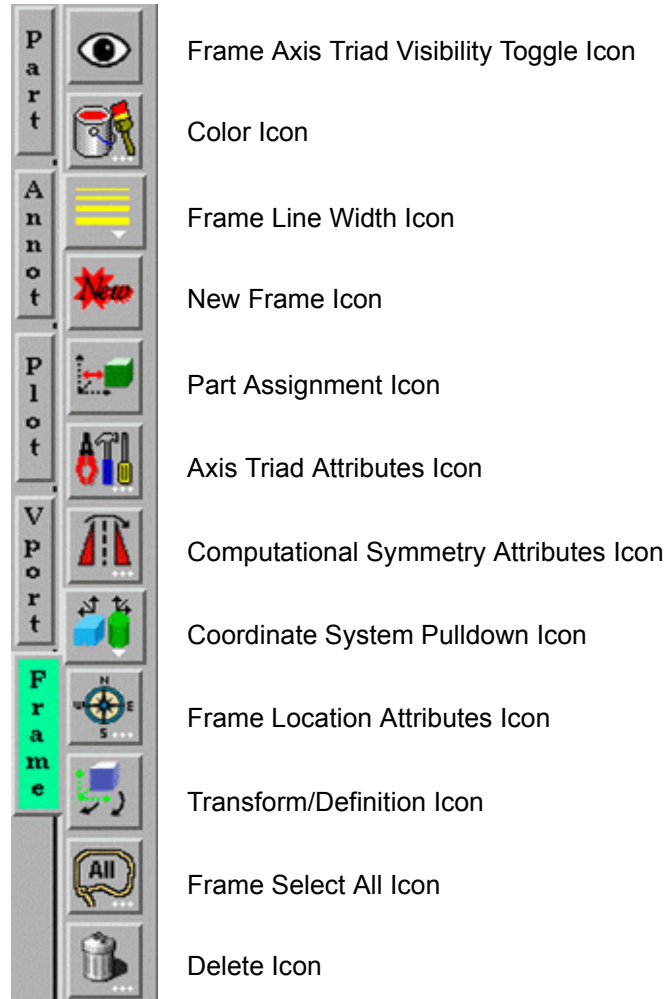

Figure 8-51  
Mode Selection Area - Frame Selected

*New Frame Icon*

Creates a new Frame to which you can assign Parts. Be aware that each time you make a copy of a Part EnSight creates a new Frame and assigns the copy to the new Frame. If Parts are selected in the Main Parts List, the new Frame's origin will be positioned at the center of the selected Parts.



Figure 8-52  
Frame Mode - Create New Frame Icon

Access: Frame Mode : Create New Frame Icon

**Part Assignment  
Icon**

Clicking this icon reassigns Part(s) selected in the Main Parts List to the currently selected Frame. (An alternative method for reassigning Parts is to edit the Ref. Frame field in the General Attributes section of the Feature Detail Editor.)



Figure 8-53  
Frame Mode - Part Assignment Icon

Access: Frame Mode : Part Assignment Icon

**Frame Axis Triad  
Visibility Toggle Icon**

Determines the visibility of the axis triad(s) of selected Frame(s). Invisible Frames are drawn in dotted lines while in Frame Mode. Default is Off.



Figure 8-54  
Frame Mode - Frame Axis Triad Visibility Toggle Icon

Access: Frame Mode : Frame Axis Triad Visibility Toggle Icon

**Color Icon**

Opens the Color Selector dialog for the specification of the color you wish to assign to a selected Frame's axis triad. A selected Frame will always be shown in the selection color while in Frame Mode.



Figure 8-55  
Frame Mode - Color Icon

Access: Frame Mode : Color Icon

**Frame Line Width  
Pulldown Icon**

Opens a pulldown menu for the specification of the width for Frame axis triad lines for the selected Frame(s).



Figure 8-56  
Frame Mode - Frame Line Width Pulldown Icon

Access: Frame Mode : Frame Line Width Icon

*Axis Triad Attributes Icon*

Opens the Frame Axis Attributes dialog for the specification of axis triad line length and labels for the selected Frame(s).

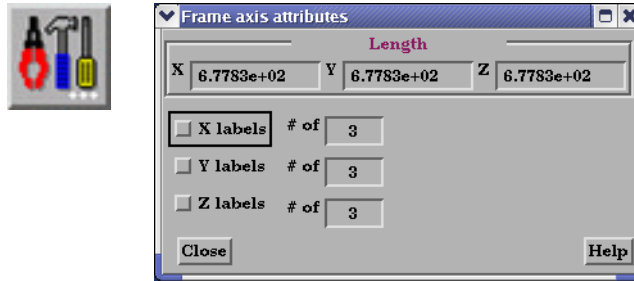

Figure 8-57  
Frame Mode - Axis Triad Attributes Icon

X Y Z

These fields allow you to specify the desired length, in model coordinates, of each of the three axes of the selected Frame's axis triad.

X Y Z Labels Toggles

Toggles on/off the display of Labels on the respective line of a selected Frame's axis triad. Labels show distance along each axis.

X Y Z # of

These fields specify the number of Labels which will appear on the respective axis.

Access: Frame Mode : Axis Triad Attributes Icon

*Computational Symmetry Attributes Icon*

Opens the Frame Computational Symmetry Attributes dialog for the specification of the type of periodic conditions which will be applied to all assigned **Model** Parts of the selected Frame. (*Note, computational symmetry does NOT work on created parts.*)

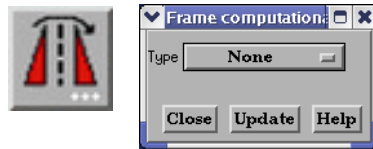

Figure 8-58  
Frame Mode - Computational Symmetry Attributes Icon

(see [How To Set Symmetry](#))

Type

Opens a pop-up menu for the selection of whether you wish the selected Frame to have no periodicity (None as shown above) or to be mirror, rotational, or translational periodic.

Mirror

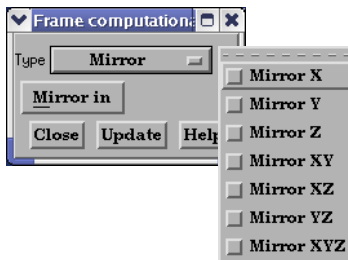

Mirror In

Specification of the type of mirror periodicity.

Mirror X	face-sharing quadrant on other side of the Y-Z plane
Mirror Y	face-sharing quadrant on other side of the X-Z plane
Mirror Z	face-sharing quadrant on other side of the X-Y plane
Mirror XY	diagonally opposite quadrant on same side of the X-Y plane
Mirror XZ	diagonally opposite quadrant on same side of the X-Z plane
Mirror YZ	diagonally opposite quadrant on same side of the Y-Z plane
Mirror XYZ	quadrant diagonally opposite through origin



## Rotational

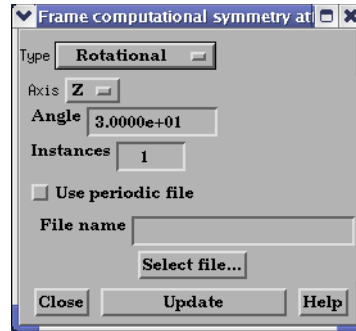

- Axis** The Frame axis about which to rotate.
- Angle** This field specifies the rotational angle (in degrees) about the selected Frame's z-axis for rotational periodicity.
- Instances** This field specifies the number of periodic instances for rotational periodicity.
- Use Periodic** If toggled On, the periodic match file specified in File Name is used for rotational symmetry.
- File Name** This field specifies the name of the periodic match file you wish to use.
- Select File...** Opens the File Selection dialog for the selection of a periodic match file.  
(see [Section 11.9, Periodic Matchfile Format](#))
- Update** Changes made in the dialog will not be applied until this button is clicked.

## Translational

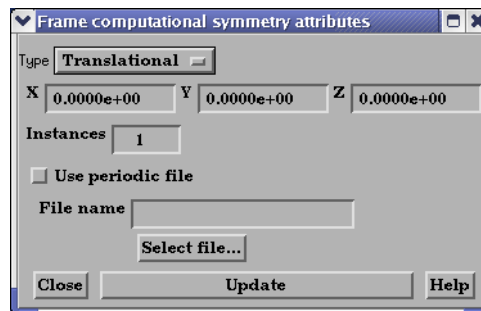

- X Y Z** These fields specify the translational offset in reference to the selected Frame's orientation.
- Instances** This field specifies the number of periodic instances for translational periodicity.
- Use Periodic** If toggled On, the periodic match file specified in File Name is used for translational symmetry.
- File Name** This field specifies the name of the periodic match file you wish to use.
- Select File...** Opens the File Selection dialog for the selection of a periodic match file.  
(see [Section 11.9, Periodic Matchfile Format](#))
- Update** Changes made in the dialog will not be applied until this button is clicked.

Access: Frame Mode : Computational Symmetry Attributes Icon

*Coordinate System  
Pull-down Icon*

Opens a pull-down menu for the selection of the type of coordinate system (rectangular, cylindrical, spherical) you wish to use for a selected Frame. All three are defined in reference to Frame 0, which is rectangular. Note that each frame's orientation vectors (which describe its orientation to Frame 0) are rectangular (as is their on-screen representation) no matter what the frame's coordinate system type. However, functions that access the frame will behave different depending on the frame's coordinate system type.



Figure 8-59  
Frame Mode - Coordinate System Pull-down Icon

**Rectangular**

The Figure below shows a rectangular frame. The origin is in reference to the Frame 0 origin, while the orientation is in reference to Frame 0's orientation.

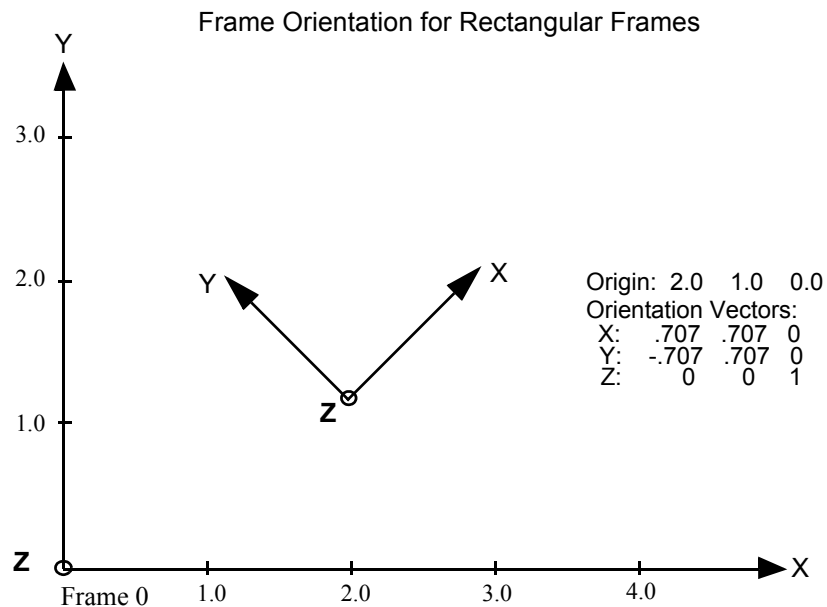

## Cylindrical

The figure below shows a cylindrical frame. The origin is in reference to the Frame 0 origin, while the orientation is in reference to Frame 0's orientation. Any function which accesses a cylindrical frame will do so in cylindrical coordinates:

- r The distance from the origin to projection point in the X-Y plane.
- $\Theta$  The angle from the X-axis to the projection point in the X-Y plane.
- Z The Z-coordinate

Frame Orientation and Coordinate System Key for Cylindrical Frames

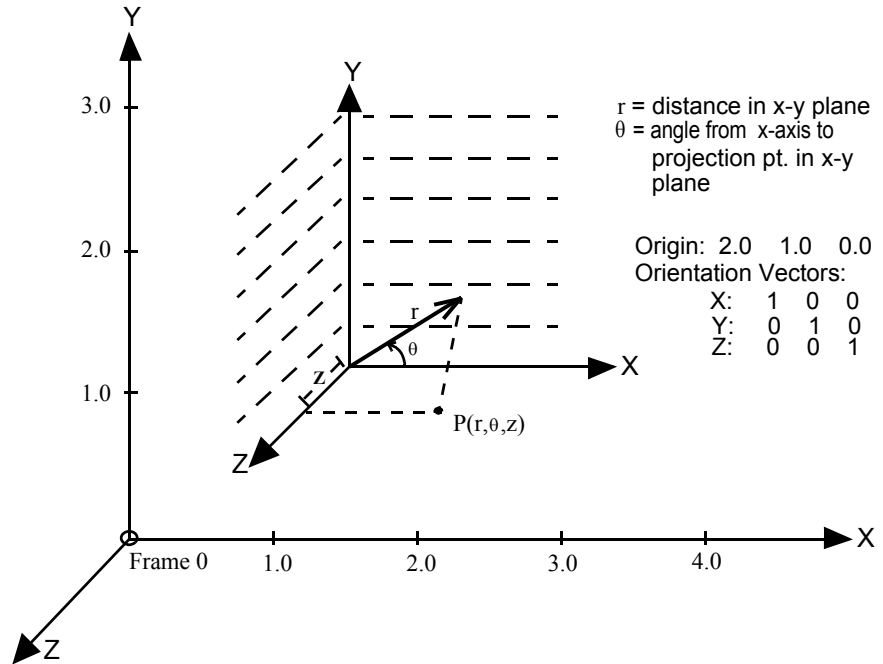

Spherical

The figure below shows a spherical frame. The origin is in reference to the Frame 0 origin, while the orientation is in reference to Frame 0's orientation. Any function which accesses a spherical frame will do so in spherical coordinates:

- ρ The distance from the origin to the point in question.
- Φ The angle measured from the Z-axis towards the projection point in the X-Z plane.
- Θ The angle from the X-axis to the projection point in the X-Y plane.

Frame Orientation and Coordinate System Key for Spherical Frames

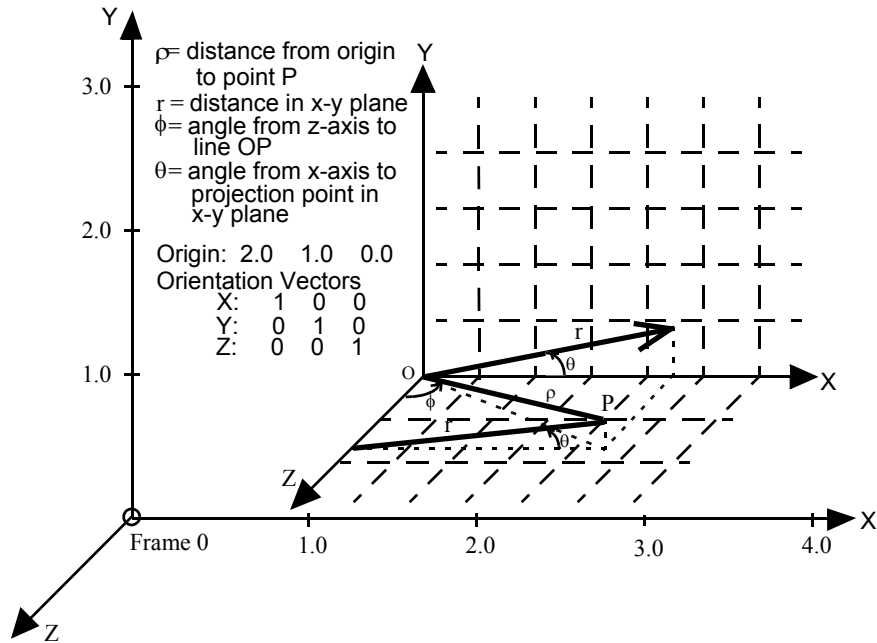

Access: Frame Mode : Coordinate System Pull-down Icon

Frame Location

Opens the Transformations Editor dialog to permit precise definition of the selected Frame(s).



Figure 8-60  
 Frame Mode - Frame Location Attributes Icon

(see Section 9.3, Frame Transform)

Access: Frame Mode : Frame Location Attributes Icon

*Transform/Definition  
Pull-down Icon*

Opens a pop-up menu for selection of desired method of Frame transformation.



Figure 8-61  
Frame Mode - Define / Transform Pull-down Icon

*Transform* - Transformations will cause the Parts assigned to the selected Frame(s) to be transformed as well as the selected Frame's axis triad. Translations will move the Frames' axis triad(s) and the assigned Parts. Rotations of Parts will take place about the selected Frame(s) axis origin.

*Definition* - User interaction in the Graphics Window or Transformation Editor will modify the selected Frame(s) origin location and/or axis orientation.

Access: Frame Mode : Transform/Definition Pull-down Icon

(see [Section 9.3, Frame Transform](#) and [Section 9.2, Frame Definition](#))

*Select All*

Selects all frames.



Figure 8-62  
Frame Mode - Select All Icon

*Delete Icon*

Deletes the selected Frame(s). (Will be prohibited if currently used by a part).



Figure 8-63  
Frame Mode - Delete Icon

Access: Frame Mode : Delete Icon

## 8.6 Quick Desktop Buttons

Quick Desktop Buttons are always available regardless of the Mode (Part, Annot, Plot, Vport, or Frame) above the Graphics Window.

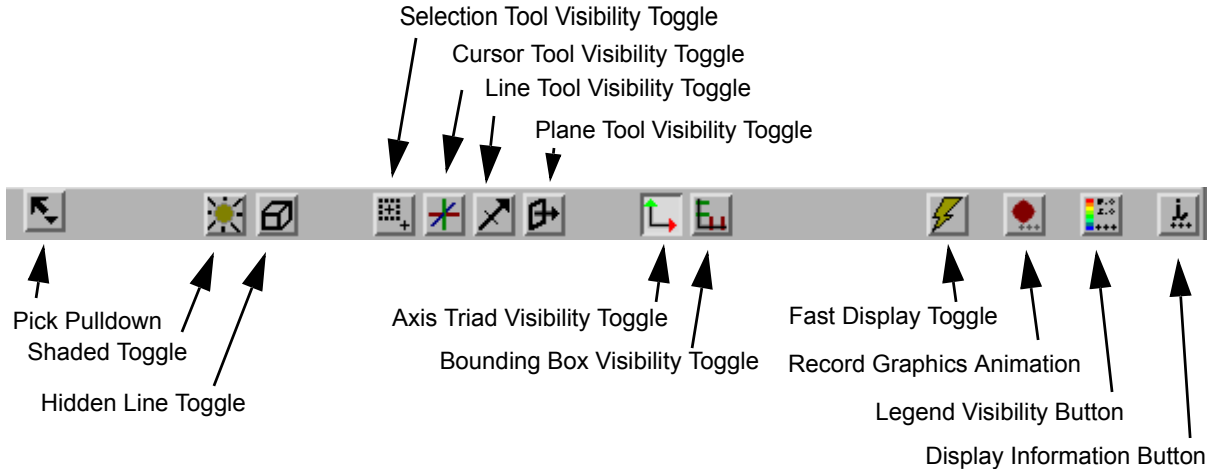

Figure 8-64  
Mode Selection Area - View Selected

*Pick Pull-down Icon*

Opens a pull-down menu for the specification of the desired type of Pick operation. The actual Pick operation is normally assigned to the “P” key on the keyboard, unless it has been reassigned under Main Menu: Edit > Preferences... Mouse and Keyboard...

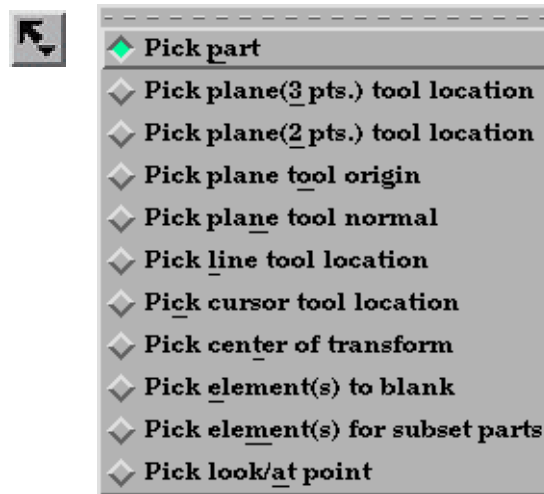

Figure 8-65  
Part Mode - Pick Pulldown Icon

**Pick Part**

When the Pick operation is performed (by default, pressing the “P” key), the Part directly under the mouse cursor is selected. To select multiple Parts, hold down the Control Key during the Pick operation. It is usually helpful to open and use the Selected Parts Window while Picking Parts. This is done from Main Menu: View > Show Selected Part(s)...

**Pick Plane (3 Pts) Tool Location**

When the Pick operation is performed (by default, pressing the “P” key), the Plane Tool will be positioned at the Picked points. Three points must be Picked to position the Plane Tool.

Pick Plane (2 Pts)	When the Pick operation is performed (by default, pressing the “P” key), you can click and drag the mouse to define a line. The Plane Tool will be positioned parallel to your current viewing angle through the defined line. Consider using this option together with the F5, F6, F7, and F8 keys which will transform the view to a standard orientation. (see Section 9.1, Global Transform)
Pick Plane Tool Origin	When the Pick operation is performed (by default, pressing the “P” key), the location of origin of the plane tool is chosen. Note that the orientation of the plane tool is unchanged with this option.
Pick Plane Tool Normal	When the Pick operation is performed (by default, pressing the “P” key), the origin of the plane tool remains unchanged, but the normal goes from the origin to the picked point.
Pick Line Tool Location	When the Pick operation is performed (by default, pressing the “P” key), the ends of the Line Tool will be centered on a plane defined by the Picked points. Two points must be Picked to position the Line Tool.
Pick Cursor Tool Location	When the Pick operation is performed (by default, pressing the “P” key), the Cursor Tool will be positioned at the Picked point.
Pick Center of Transformation	When the Pick operation is performed (by default, pressing the “P” key), the center of global transformation is positioned at the Picked point.
Pick Elements to blank	When the Pick operation is performed (by default, pressing the “P” key), the Element that is chosen is visually removed from the graphics screen. The element still remains in the model and is used for all calculations, just is not rendered on the graphics screen. Use the Element Blanking Button in Part Mode to enable / disable and restore visibility.

Element Blanking Button



Pick Elements for Subset Parts	When the Pick operation is performed (by default, pressing the “P” key), the Element that is chosen is added to the list of elements in the subset part list.
Pick Look At Point	When the Pick operation is performed (by default, pressing the “P” key), the Look At Point is positioned at the Picked point. The Look From Point is also adjusted to preserve the distance (between the two Points) and vector that existed prior to the Pick operation. (see Section 9.7, Look At/Look From)

Access: Part Mode : Pick Pull-down Icon

### *Global Shaded Toggle Icon*

Toggles on/off global Shaded (default is off) which displays all Parts in a more realistic manner by making hidden surfaces invisible while shading visible surfaces according to specified lighting parameters. Performs the same function as Main Menu > View > Shaded toggle button and the Desktop > Shaded button.

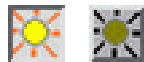

Figure 8-66  
View Mode - Shaded Toggle Icon ON / OFF

When toggled-off, all visible Parts are shown as line drawings. Shaded may be turned off for individual Parts using the Shaded toggle in the Parts Mode Icon Bar or the Feature Detail Editor for each type of Part. It can also be turned off for a Particular viewport in the Viewport Special Attributes Icon under VPort Mode.

Shaded require more time to redraw than a line-mode display (the default), so you may wish to first set up the Graphics Window as you want it, then turn on Shaded to see the final result. It is possible to improve graphics performance when Shaded is on by also toggling on Static Lighting (Main Menu > View > Static Lighting). To shade surfaces, a

Part's representation on the Client must include surfaces - (2D elements). Any 1D elements of Parts displayed with Shaded on will continue to be drawn as lines. Lighting parameters for brightness and reflectivity are specified independently in the Feature Detail Editor for each type of Part.

Access: View Mode Icon Bar: Shaded Toggle Icon  
 or: EnSight dialog > View > Shaded  
 or: Desktop > Shaded

(see Section 6.4, [View Menu Functions](#) and [How To Set Drawing Style](#))

### Troubleshooting Hidden Surfaces

Problem	Probable Causes	Solutions
Graphics Window shows line drawing after toggling on Shaded.	Shaded is toggled off for some or all individual Parts.	Toggle Shaded on for individual Parts with the Shaded Icon in Part Mode or in the Feature Detail Editor dialog.
	There are no surfaces to shade—all Parts have only lines.	If Parts are currently in Feature Angle representation, change the representation. If model only has lines, you can not display shaded images.
	Element Visibility has been toggled off for some or all Parts.	Toggle Element Visibility on for individual Parts in the Feature Detail Editor dialog.
<i>Global Hidden Line Toggle Icon</i>	Toggles on/off global Hidden Line (default is off) which simplifies a line-drawing display by making hidden lines—lines behind surfaces—invisible while continuing to display other lines. Performs the same function as Main Menu > View > Hidden Line Toggle and the Desktop > Hidden Line button.	



Figure 8-67  
View Mode - Global Hidden Line Toggle Icon ON / OFF

Hidden Line can be combined with Shaded to display both shaded surfaces and the edges of the visible surface elements. Hidden Line applies to all Parts displayed in the Graphics Window but it can be toggled-on/off for individual Parts using the Feature Detail Editor or the Part Mode: Hidden Line Toggle button.

To have lines hidden behind surfaces, you must have surfaces (2D elements). If the representation of the in-front Parts consists of 1D elements, the display is the same whether or not you have Hidden Lines mode toggled-on.

During interactive transformations, the display reverts to displaying all lines. When you release the mouse button, the Main View display automatically resumes Hidden Line mode (assuming it is toggled on at that time).

The Hidden line option will not be active during playback of flipbook objects animations.



### Hidden Line Overlay

If you toggle Hidden Line on while Shaded is already on, the lines overlay the surfaces. EnSight will prompt you to specify a color for the displayed lines (you do not want to use the same color as the surfaces since they then will be indistinguishable from the surfaces). The default is the Part-color of each Part, which may be appropriate if the surfaces are colored by a color palette instead of their Part-color.

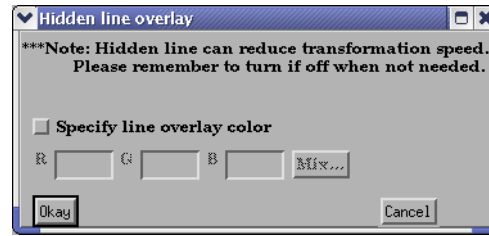

Figure 6-68  
Hidden Line Overlay dialog

**Specify Line Overlay Toggle** Toggle-on if you want to specify an overlay color. If off, the overlay line color will be the same as the Part color.

**R, G, B** The red, green, and blue components of the hidden line overlay. These fields will not be accessible unless the Specify Overlay option is on.

**Mix...** Click to interactively specify the constant color used for the hidden line overlay using the Color Selector dialog. (See [Section 8.1, Color Selector](#)) and [How To Change Color](#))

Access: View Mode Icon Bar: Global Hidden Line Toggle Icon  
or: Main Menu > View > Hidden Line  
or: Desktop > Hidden Line

(See [How To Set Attributes](#))

### Selection Tool Visibility Toggle

Toggles on/off global visibility of the Selection Tool (default is off)



Figure 8-69  
View Mode - Global Selection Tool Visibility Toggle Icon ON / OFF

: Main Menu > Tools > Region Selector

### Cursor Tool Visibility Toggle

Toggles on/off global visibility of the Cursor Tool (default is off)

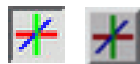

Figure 8-70  
View Mode - Global Cursor Tool Visibility Toggle Icon ON / OFF

: Main Menu > Tools > Cursor

### Line Tool

Toggles on/off global visibility of the Line Tool (default is off)

*Visibility Toggle*



Figure 8-71  
View Mode - Global Line Tool Visibility Toggle Icon ON / OFF

: Main Menu > Tools > Line

*Plane Tool  
Visibility Toggle*

Toggles on/off global visibility of the Plane Tool (default is off)



Figure 8-72  
View Mode - Global Plane Tool Visibility Toggle Icon ON / OFF

: Main Menu > Tools > Plane

*Global Axis Triad*

Toggles on/off the visibility (default is off) of the Global Axis triad.



Figure 8-73  
View Mode - Global Axis Triad Visibility Toggle Icon

The Global Axis triad shows the point and axes around which Global rotations occur.

: Main Menu > View > Axis Triad Visibility

*Bounding Box  
Visibility Toggle Icon*

This toggles on and off a 2D or 3D bounding box grid describing the upper and lower coordinates in each of the X-, Y-, and Z-directions.

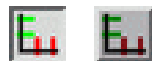

Figure 8-74  
View Mode - Global Bounding Box Visibility Toggle Icon

The Global Axis triad shows the point and axes around which Global rotations occur.

: Main Menu > View > Bounds Visibility

*Fast Display  
Toggle Icon*

This toggles on and off the Fast Display feature. This feature reduces a model to a simple representation prior to doing a transformation such as rotate or translate in order to speed up the rendering. Simple representations include Box, Points, or Reduced Polygon which can be chosen from the Fast Display Representation icon in Part Mode.



*Fast Display Representation  
Icon*

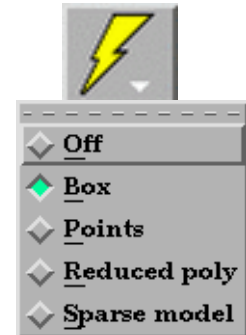

Figure 8-75  
View Mode - Global Fast Display Toggle Icon ON / OFF  
and button and pull-down

Fast Display allows faster model translation or rotation for large models.

: Main Menu > View > Fast Display

*Record Animation  
Button*

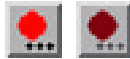

Figure 8-76  
View Mode - Global Record Animation Toggle Icon ON / OFF

The Record Active Animation Toggle will only turn ON if you have an active animation (flipbook, or streaming transient data via the clock icon, or animated particle traces, or spin mode where you press F4 and drag the cursor to spin the model, or clip in auto or auto cycle interactive mode, or an isosurface in auto or auto cycle interactive mode). This button does not record keyframing, which has its own button in the Keyframe Quick Interaction Area.

*Legend Visibility  
Toggle Icon*



Figure 8-77  
View Mode - Legend Visibility Button

The Legend Visibility Button will bring up the Legend Visibility Dialog which allows control of legend visibility for all active variables. The Global Legend Visibility Flag must be ON to see the legend, see Main Menu > View > Legend.

*Display Information  
Icon*

Click on this icon to see a message related to the most recent EnSight task that you've completed. This icon is red (error message), yellow (caution message) or green (OK or no message) depending upon the result of your most recent EnSight task.



Figure 8-78  
View Mode - Global Display Information Toggle Icon States



# 9 Transformation Control

Included in this chapter:

**General Description**

**Section 9.1, Global Transform**

**Section 9.2, Frame Definition**

**Section 9.3, Frame Transform**

**Section 9.4, Tool Transform**

**Section 9.5, Center Of Transform**

**Section 9.6, Z-Clip**

**Section 9.7, Look At/Look From**

**Section 9.8, Copy/Paste Transformation State**

## *General Description*

An essential feature of postprocessing is the reorientation of the visualized model in order to see it from a number of different vantage points. Basic transformations include *rotating* (about an axis or axis origin point), *translating* (up, down, left, right), and *zooming* (moving the model toward or away from you). When EnSight reads in a geometry file, it assigns all model parts to the same Frame of reference: Frame 0. Frame 0 corresponds to the model coordinate system (defined when the model was created).

Using the Frame Mode, it is possible to create additional frames and reassign parts to them. In fact, when you copy a part, a new Frame is automatically created and the part copy is assigned to the new Frame. (See Section 8.6 Frame Mode for further discussion).

Just after all parts of your model have been read in, EnSight centers the model in the Graphics Window by placing the geometric center of the model at the *Look At Point* which is always located in the center of the Graphics Window. Initially - before any Global translations are made -the origin for the *Global Axis* is located at the Look At Point.

There are seven Editor Functions available within the Transformation Editor, Global Transform, Frame, Tools, Z-Clip, Look At/Look From, Copy Transformation State, and Paste Transformation State. (The Transformation Editor dialog is opened by clicking the Transf Edit... button)

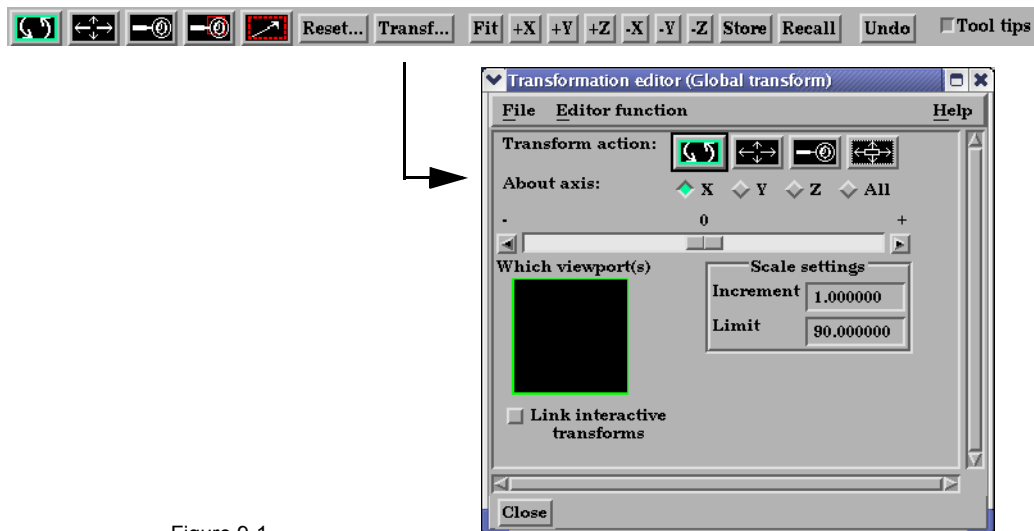

Figure 9-1  
Transf Edit... button and Transformation Editor dialog

Transformations performed within the Editor affect the selected viewports and/or frames. The transforms from one viewport can be copied to another by selecting the viewport to be copied, selecting *Copy Transformation State*, selecting the viewport(s) to be modified, and selecting *Paste Transformation State*.

#### File button Pull-down Menu

- File > Save View      This opens the Save View dialog which allows you to save in a file the view (orientation) of the model you have created in the Graphics Window and any Viewports by selecting Save View and then entering the name of the file.
- File > Restore View      Opens the Restore View dialog which allows you to specify the name of a file in which you previously stored a view. Clicking Okay in this dialog restores the view only in the selected Viewports.

## 9.1 Global Transform

Transformations you make while in Part Mode (rotations, translations, zoom, scale) are performed globally. Global transformations affect the *entire* model as a unit and move all Frames, parts, and *visible* tools relative to the Global Axis. You can make the Global Axis triad (which pinpoints the Global Axis Origin) visible by selecting Axis Visibility > Axis - Global from View in the Main Menu or by clicking the Global Axis Visibility Toggle Icon on the desktop.



Figure 9-2  
Global Axis Visibility Toggle Icon and Global Axis triad

You can also show the global frame orientation by toggling it on from Desktop > Axis.

Most Global transformations you will make will be done interactively. Interactive Transformations normally affect only the single, selected viewport (the one which the mouse pointer is in when you click the left mouse button). The exception to this is if when you toggle on *Link Interactive Transforms*, causing the selected viewports in the Transformation Editor dialog to all transform together. You choose the type of transformation you wish to perform from among the Transformation Control Icons.

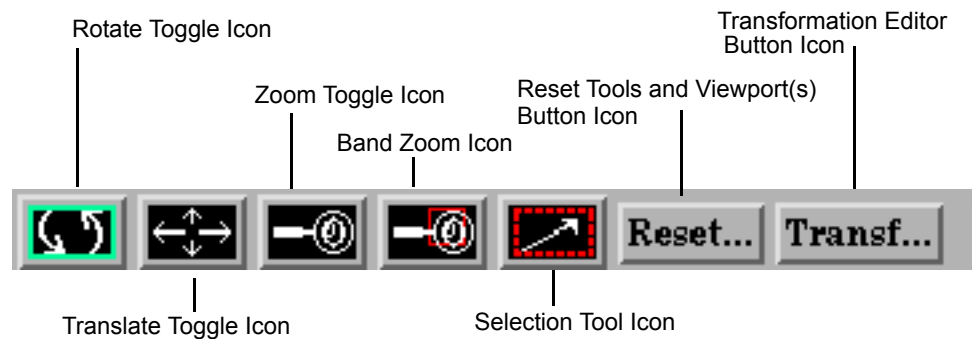

Figure 9-3  
Transformation Control Area in View or Part Mode

### Rotate Toggle

**Interactive Rotation** When this toggle is on, clicking the left mouse button and dragging horizontally will rotate the scene (including any tools that are visible) about the Global Y axis.

Clicking the left mouse button and dragging vertically will rotate the scene (including any tools that are visible) about the Global X axis.

Holding the Control Key down and then clicking the left mouse button and dragging will rotate the scene (including any tools that are visible) about the Global Z Axis.

**Rotation Using Function Keys** Pressing the F1, F2, or F3 function keys will rotate the scene 45 degrees about the X, Y, or Z axis respectively. Holding the Control Key down while pressing these keys will rotate the scene by -45 degrees. The mouse must be located in the graphics window for these keys to work.

Precise Rotation

When the Transformation Editor is open under Global Transform and the Rotate toggle is selected, the dialog will be configured to permit precise Rotation.



Figure 9-4  
Transformation Editor for Exact Global Rotation

You may rotate the entire scene (including any tools that are visible) precisely about the X, Y, Z, or All axes by clicking on the appropriate axis of rotation toggle and:  
 entering the desired rotation in (+ or -) degrees in the Increment field and pressing Return,  
 clicking the stepper buttons at each end of the slider bar (each click will rotate the model by the number of degrees specified in the Increment field), or  
 dragging the slider in the positive or negative direction to the desired number of degrees you wish to rotate the model (the Limit Field specifies the maximum number of degrees of rotation performed when the slider is pulled to either end of the slider bar).

Translate Toggle

Interactive Translation

When this toggle is on, you can transform objects interactively in the Global X-Y plane (or by holding down the Control key, in Z). Clicking the left mouse button and dragging will translate the scene (including any tools that are visible) up, down, left or right (or forward or backward).

Precise Translation

When the Transformation Editor is open under Global Transform and the Translate toggle is selected, the dialog will be configured to permit precise Translation.

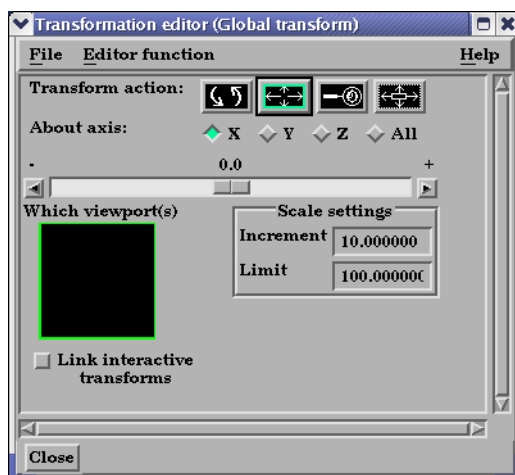

Figure 9-5  
Transformation Editor for Exact Global Translation

You may translate the entire scene (including any tools that are visible) precisely along the X, Y, Z, or All axes by clicking on the appropriate direction toggle and:

1. entering the desired translation in (+ or -) model coordinate units in the Increment field and pressing Return, then



- clicking the stepper buttons at each end of the slider bar (each click will translate the model by the number of model coordinate units specified in the Increment field), or
- dragging the slider in the positive or negative direction to the desired number of model coordinate units you wish to translate the model and then releasing the slider (the Limit Field specifies the maximum number of model coordinate units that the model is translated when the slider is pulled to either end of the slider bar).

### Zoom Toggle

#### Interactive Zooming

A Zoom transform is really an adjustment of the Look From Point, which you might also think of as the Camera Position. When this toggle is on, clicking and dragging to the left or down will zoom-in, that is it will move the Look From Point closer to the Look At Point. Clicking and dragging to the right or up will zoom-out, that is it will move the Look From Point farther away from the Look At Point. If you hold down the Control key while interactively zooming, you will “pan”, i.e. move both the Look At and Look From Points in the direction of the mouse movement.

(see Section 9.7, Look At/Look From)

As you Zoom in or out, be aware that you may clip the model with the Front or Back Z-Clip planes since they move in relationship to the Look From Point, always maintaining the distance from the Look From Point specified in the Transformation Editor dialog: Editor Function > Z-Clip.

(see Section 9.6, Z-Clip)

#### Precise Zooming

When the Transformation Editor is open under Global Transform and the Zoom toggle is selected, the dialog will be configured to permit precise Zoom.



Figure 9-6  
Transformation Editor for Exact Global  
Zoom

You may precisely adjust the position of the Look From Point (with respect to the Look At Point) by:

- entering in the Increment Field the desired modification (+ or -) in the distance between the two Points (a value of .5 will increase the distance to be equal to 1.5 the current distance, a value of 1.0 will double the current distance), then
- clicking the stepper buttons at each end of the slider bar (each click will increase or decrease the distance between the two Points by the factor specified in the Increment field), or
- dragging the slider in the positive or negative direction to the desired

modification factor and then releasing the slider (the Limit Field specifies the maximum modification factor for the distance between the two Points when the slider is pulled to either end of the slider bar).

#### Band Zoom Button

You specify the area of interest by clicking and dragging the white rectangle (rubber band) around the area you wish to zoom in on. Immediately after you perform the Band Zoom operation however, EnSight will switch to the regular Zoom Transformation. So, each time you click on the Band Zoom button, EnSight allows you to perform one Band Zoom operation and subsequent clicking/dragging actions you make in the Graphics Window perform regular Zoom transformations.

Band Zoom combines the functionality of a zoom-in transform as described above with a panning operation. The effect of performing a Band Zoom is that the area of interest that you specify will be centered in and will fill the selected viewport. EnSight adjusts the transformation center to be in the center of the area you specified.

The Transformation Editor is inactive for the Band Zoom Operation.

#### Scale Toggle

Interactive modifications to scale are not permitted. When the Transformation Editor is open under Global Transform and the Scale toggle is selected, the dialog will be configured to permit precise adjustments to the scale of the scene.

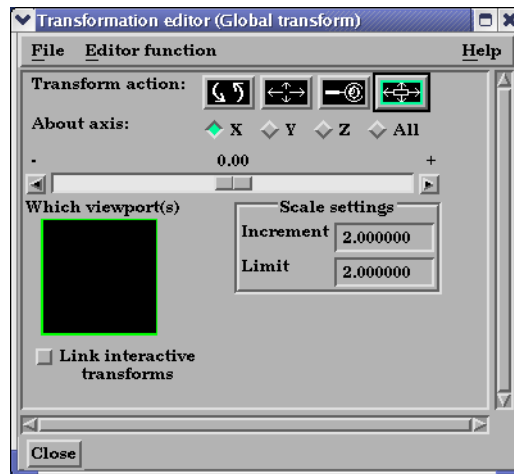

Figure 9-7  
Transformation Editor for Exact Global  
Scaling

You may precisely rescale the scene in the X, Y, Z, or All axes by clicking on the appropriate scaling direction and:

1. entering in the Increment Field the desired rescale factor and pressing Return (A value of .5 will reduce the scale of the scene in the chosen axis by half. A value of 2 will double the scale in the chosen axis. *Be aware that entering a negative number will invert the model coordinates in the chosen axis.*), then
2. clicking the stepper buttons at each end of the slider bar (Clicking the left stepper button will apply 1/Increment value to the scale. Clicking the right stepper button will apply the entire Increment value to the scale), or
3. dragging the slider in the positive or negative direction to the desired scale factor and then releasing the slider. (Dragging the slider to the leftmost position will apply 1/Limit value to the scale. Dragging the slider to the rightmost position will apply the entire Limit value to the scale.).

*Reset Tools & Viewports Button*

Clicking the Reset Tools and Viewport(s) button in the Transformation Control Area will open the Reset Tools and Viewport(s) dialog

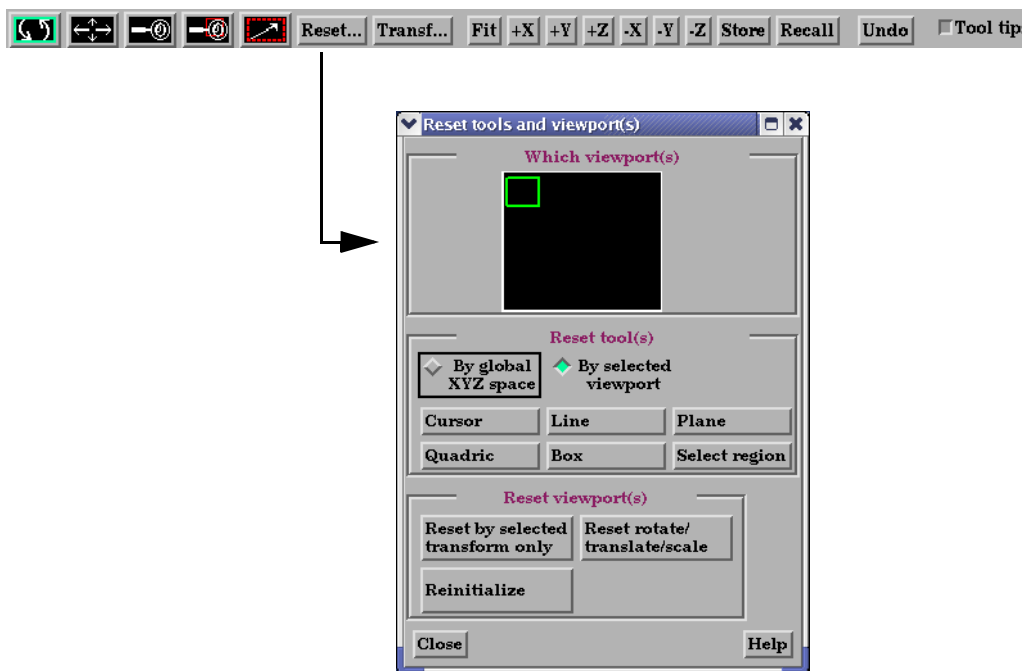

Figure 9-8  
Reset Tools and Viewport(s) dialog

- By Global XYZ Space Toggle      When enabled, clicking a Reset button will cause the Cursor, Line, Plane, or Quadric Tool to reset to its initial default position.
  - By Selected Viewport Toggle      When enabled, clicking a Reset button will cause the Cursor, Line, Plane, or Quadric Tool to be repositioned in the center of the geometry for the selected viewport.
  - Reset Cursor      Clicking this button will cause the Cursor Tool to reset according to the “By” toggle.
  - Reset Line      Clicking this button will cause the Line Tool to reset according to the “By” toggle.
  - Reset Plane      Clicking this button will cause the Plane Tool to reset according to the “By” toggle.
  - Reset Quadric      Clicking this button will cause the currently selected Quadric Tool to reset according to the “By” toggle.
  - Reset Box      Clicking this button will cause the Box Tool to reset according to the “By” toggle.
  - Reset Select region      Clicking this button will cause the selection Tool to reset according to the “By” toggle.
  - Reset By Selected Transform Only      Clicking this button will cause the transformation selected in the Transformation Control Area to reset for the viewports selected in the dialog’s Viewport(s) area.
  - Reset Rotate/Translate/Scale      Clicking this button will cause the rotate, translate, and scale transformations to reset for the viewports selected in the dialog’s Viewport(s) area.
  - Reinitialize      Clicking this button will cause the viewports selected in the dialog’s Viewport(s) area to reset and recenter on the Parts which are visible in the Viewport(s).
- Reset using Function Keys      Pressing the F5 button will change the scene in the current viewport to the standard “right side” view. Similarly, pressing F6 will show a “top” view and F7 a “front” view. Pressing F8 will restore the view to the one which existed before F5, F6, or F7 were pressed. If the Control Key is pressed at the same time as F5, F6, or F7, then the current view will be stored to the selected button.

## 9.2 Frame Definition

When Frame Definition has been chosen from the Transform/Definition button Pulldown menu or from the Editor Function menu in the Transformation Editor dialog, then actions you make will affect only the definition (origin and orientation) of the selected Frame(s). Frame 0's definition however, can not be changed.

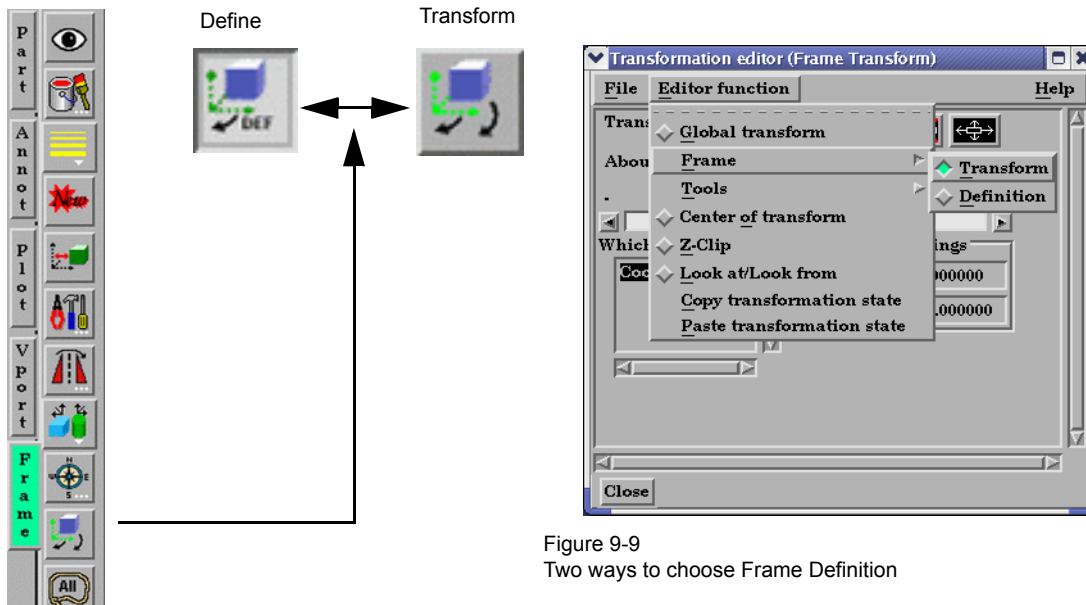

Figure 9-9  
Two ways to choose Frame Definition

A Frame's definition should be adjusted before it is transformed under Frame Transform (as described in the previous pages). Transformations under Frame Transform are always about the Frame's origin and orientation. Failure to define the proper origin position and orientation of a Frame will result in unexpected transformation behavior.

You choose the type of transformation you wish to perform (rotate or translate) from the Transformation Control Icons. Note that you cannot perform zoom, scale, or reset operations under Frame Definition.

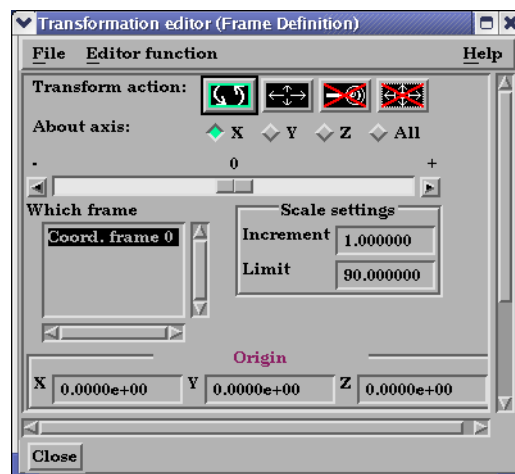

Figure 9-10  
Transformation Control Area in Frame Mode under Frame Definition

**Rotate Toggle**

Interactive  
Modification of  
Orientation

When this toggle is on, clicking the left mouse button and dragging modifies the orientation of the selected Frame(s). Clicking on the end of the X axis will limit the rotation to be about the Y axis. Similarly, clicking on the end of the Y axis will limit the rotation to be about the X axis.

Precise Modification  
of Orientation

When the Transformation Editor is opened under Frame Definition and the Rotate toggle is selected, the dialog will be configured to permit precise rotation (modification of the orientation) of the selected Frame(s).

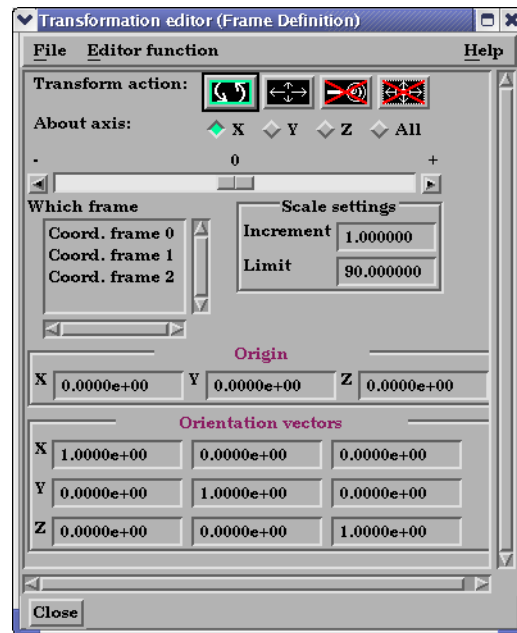

Figure 9-11  
Transformation Editor for Exact Rotation for Selected Frame(s) Only

You may rotate the selected Frame(s) precisely about their X, Y, Z, or All axes by clicking on the desired axis and:

1. entering the desired rotation in (+ or -) degrees in the Increment field and pressing Return, then
2. clicking the stepper buttons at each end of the slider bar (each click will rotate the selected Frame(s) by the number of degrees specified in the Increment field), or
3. dragging the slider in the positive or negative direction to the desired number of degrees you wish to rotate the selected Frame(s) (the Limit Field specifies the maximum number of degrees of rotation performed when the slider is pulled to either end of the slider bar).

Origin XYZ  
Orientation XYZ

You may precisely position both the origin and the axis of a selected Frame by entering in the desired coordinates in the Origin and Orientation Vector X Y Z fields and then pressing Return. These fields can be used regardless of whether the Rotate or the Translate toggle is selected.

*Translate Toggle*

Interactive  
Translation of  
Origin Position

When this toggle is on, clicking the left mouse button and dragging will translate the selected Frame(s) (other than Frame 0) up, down, left, or right within the viewport. Holding down the Control key while dragging will translate the selected Frame(s) forward or backward.

Precise Translation  
of Origin Position

When the Transformation Editor is open under Frame Definition and the Translate toggle is selected, the dialog will be configured to permit precise Translation (modification of the origin position) of the selected Frame(s).

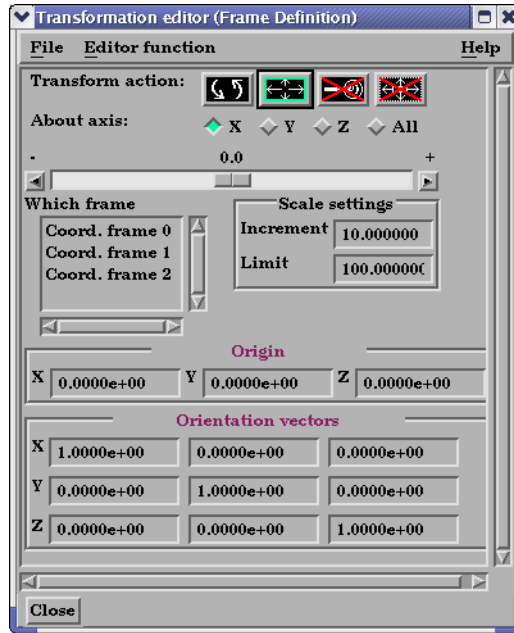

Figure 9-12  
Transformation Editor for Exact Translation of Selected Frames

You may translate the selected Frame(s) precisely along the X, Y, Z, or All axes by clicking on the desired axis direction and:

1. entering the desired translation in (+ or -) model coordinate units in the Increment field and pressing Return, then
2. clicking the stepper buttons at each end of the slider bar (each click will translate the selected Frame(s) by the number of model coordinate units specified in the Increment field), or
3. dragging the slider in the positive or negative direction to the desired number of model coordinate units you wish to translate the selected Frame(s) and then releasing the slider (the Limit Field specifies the maximum number of model coordinate units that the Frame is translated when the slider is pulled to either end of the slider bar).

## 9.3 Frame Transform

When Frame Transform has been chosen from the Transform/Definition button Pulldown menu or from the Editor Function menu in the Transformation Editor dialog, transformations you make will affect the selected Frame(s) and the Parts assigned to them.

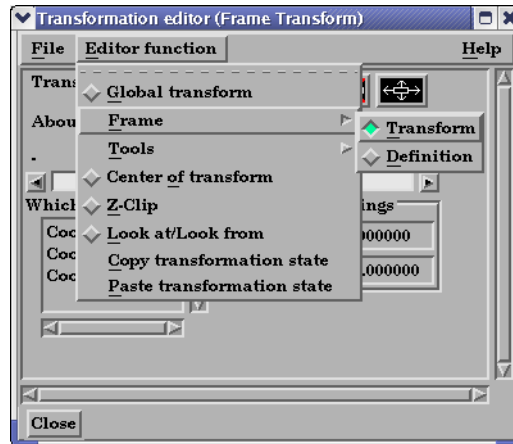

Figure 9-13  
Two ways to choose Frame Transform

*Note:* Before any transformations are performed on a Frame, its definition should be modified (if necessary) as described later in this section. Transformations always occur about a Frame's origin and orientation. Failure to define the proper position and orientation of the Frame will result in unexpected transform behavior. Thus, the order of dealing with things should be 1) define the frame, 2) assign parts to the frame, 3) transform according to the frame.

You choose the type of transformation you wish to perform from among the Transformation Control Icons in the Transformation Editor dialog. Note that under Frame Transform, you cannot perform the zoom operation.

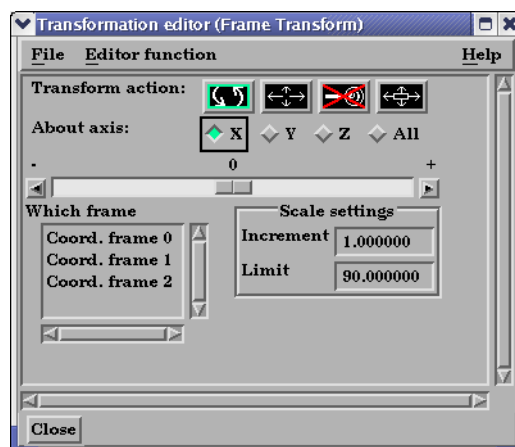
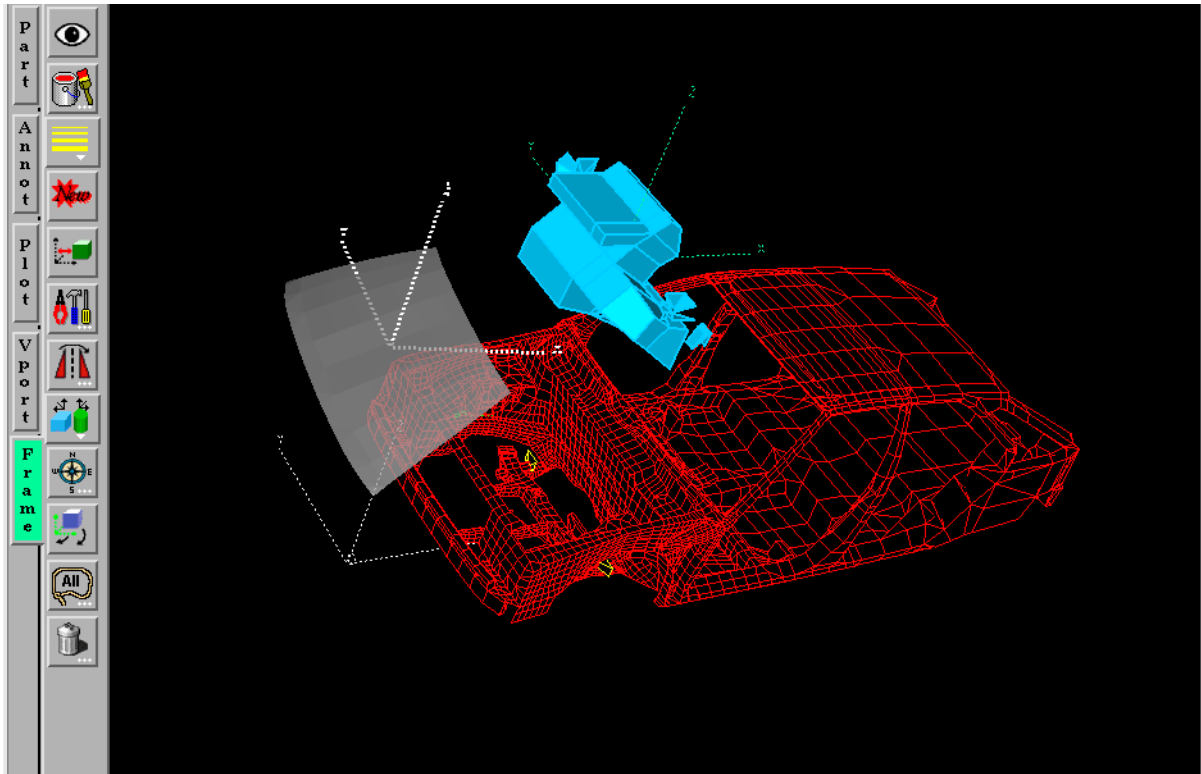

Figure 9-14  
Transformation Control Area in Frame Mode under Frame Transform



*Rotate Toggle*

**Interactive Rotation** When this toggle is on, clicking the left mouse button and dragging causes the selected Frame(s) and all Parts assigned to the Frame(s) to rotate about the Origins of each Frame Axis. Holding down the Control key while dragging will rotate the selected Frame(s) and all assigned Parts about a Z axis perpendicular to the screen.

**Precise Rotation** When the Transformation Editor is open under Frame Transform and the Rotate toggle is selected, the dialog will be configured to permit precise Rotation.

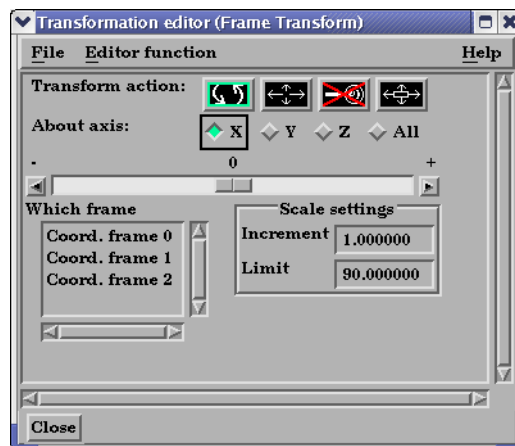

Figure 9-16  
Transformation Editor for Precise Rotation under Frame Transform



You may rotate the selected Frame(s) and assigned Part(s) precisely about the X, Y, Z, or All axes, as the orientation of the axes were defined when the Frame was first created by:

1. entering the desired rotation in (+ or -) degrees in the Increment field and pressing Return, then
2. clicking the stepper buttons at each end of the slider bar (each click will rotate the selected Frame(s) and assigned Part(s) by the number of degrees specified in the Increment field), or
3. dragging the slider in the positive or negative direction to the desired number of degrees you wish to rotate the selected Frame(s) and assigned Part(s) (the Limit Field specifies the maximum number of degrees of rotation performed when the slider is pulled to either end of the slider bar).

#### Translate Toggle

##### Interactive Translation

When this toggle is on, you can transform objects interactively in the X-Y plane (or by holding down the Control key, in Z). Clicking the left mouse button and dragging will translate the selected Frame(s) and all assigned Part(s) up, down, left or right (or forward or backward) within the selected viewport.

##### Precise Translation

When the Transformation Editor is open under Frame Transform and the Translate toggle is selected, the dialog will be configured to permit precise Translation.

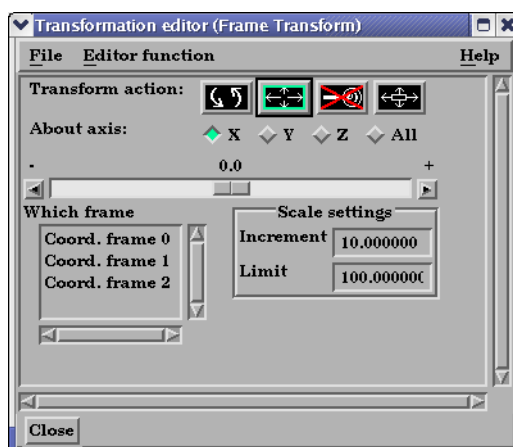

Figure 9-17  
Transformation Editor for Precise Translation under Frame Transform

You may translate the selected Frame(s) and all Parts assigned to them precisely along the X, Y, Z, or All axes by:

1. entering the desired translation in (+ or -) model coordinate units in the Increment field and pressing Return, then
2. clicking the stepper buttons at each end of the slider bar (each click will translate the selected Frame(s) and assigned Part(s) by the number of model coordinate units specified in the Increment field), or
3. dragging the slider in the positive or negative direction to the desired number of model coordinate units you wish to translate the selected Frame(s) and assigned Part(s) and then releasing the slider (the Limit Field specifies the maximum number of model coordinate units that the model is translated when the slider is pulled to either end of the slider bar).

*Scale Toggle*

When the Transformation Editor is open under Frame Transform and the Scale toggle is selected, the dialog will be configured to permit precise scale.

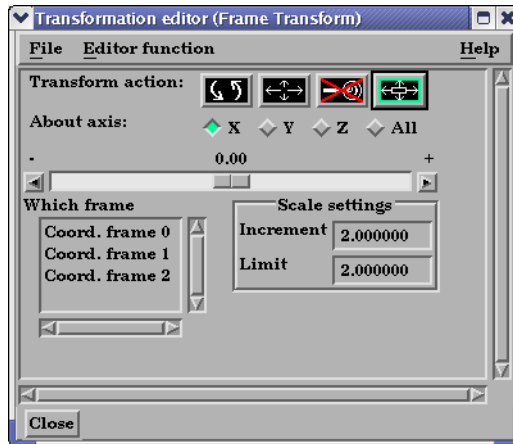

Figure 9-18  
Transformation Editor for Exact Scaling under Frame Transform

You may precisely rescale the selected Frame(s) and assigned Part(s) in the X, Y, Z, or All axes by:

1. entering in the Increment Field the desired rescale factor and pressing Return (A value of .5 will reduce the scale of the selected Frame(s) and assigned Part(s) in the chosen axis by half. A value of 2 will double the scale in the chosen axis. *Be aware that entering a negative number will invert the model coordinates in the chosen axis.*), then
2. clicking the stepper buttons at each end of the slider bar (Clicking the left stepper button will apply 1/Increment value to the scale. Clicking the right stepper button will apply the entire Increment value to the scale), or
3. dragging the slider in the positive or negative direction to the desired scale factor and then releasing the slider. (Dragging the slider to the leftmost position will apply 1/Limit value to the scale. Dragging the slider to the rightmost position will apply the entire Limit value to the scale.)

## 9.4 Tool Transform

Transformation of the Cursor, Line, Plane, Box, Selection, and Quadric (cylinder, sphere, cone, and revolution) Tools is covered in depth in Chapter 6.

(see *Tool Positions* in [Section 6.5, Tools Menu Functions](#))

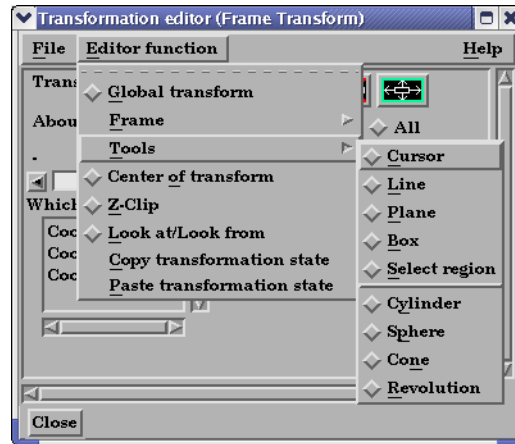

Figure 9-19  
Transformation Editor Tools Selections

## 9.5 Center Of Transform

The point about which global transformations will occur can be specified exactly if desired. Simply enter the model coordinates for the location of this point.

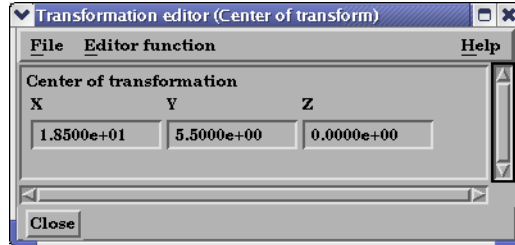

Figure 9-20  
Transformation Editor Center of Transform dialog

## 9.6 Z-Clip

EnSight displays the scene in a three-dimensional, rectangular workspace that has finite boundaries on all sides. Even if you rotate the model, you are always looking into the workspace from the front side. The top-to-bottom and side-to-side boundaries of the workspace are analogous to looking out a real window—the window frame limits your view. In addition, since the memory of your computer is finite, your workspace also has limits in the front-and-back direction.

The front boundary is the *Front Clipping Plane* (or the *Near Plane*) and the rear boundary is the *Back Clipping Plane* (or the *Far Plane*). Only the portion of the scene *between* these two planes is visible—the rest of the model (if any) is *clipped* and therefore invisible. By convention, the front-to-back direction of the workspace is the Z direction. Hence, the front and back clipping planes are together called the *Z-Clip Planes*. Note that the Z-direction in the workspace is always in-and-out of the screen and is completely independent of the Z-direction of the model Frame (Frame 0).

### *Z-Clip Positions*

The position of the Z-Clip planes is specified in terms of their *distance from the Look From Point* in the distance units implied by the model-geometry data. By default, the planes automatically move as the model moves.

Initially, EnSight positions the Z-Clip Planes based on the dimensions of the model parts read to the Client, with some extra space for you to perform transformations. You can reposition the planes when doing so becomes necessary or desirable.

Each viewport has its own independently adjustable set of Z-Clip Planes.

### *Using Z-Clip Planes*

You can use Z-Clip planes to *deliberately* clip-away portions of the model you are not interested in, or which are getting in the way of what is of interest. For example, you can clip-away both a front-portion and a back-portion of a model to reduce the number of node and element labels displayed. *Z-Clip Planes and* EnSight uses your workstation's graphics hardware to perform all graphics

### *Hidden Surfaces*

manipulations, including the display of solid surfaces. The appearance of a solid model is created by *not* displaying *hidden surfaces*—surfaces hidden behind nearer surfaces. The algorithm used by the graphics hardware to do this task—*Z-buffering*—is a simple algorithm which compares Z-values to calculate which surfaces are closest to you and thus visible. Z-buffering is normally performed in integer arithmetic, and on most graphics systems is confined to 24 bits of resolution. Hence, the coordinates in Z must be mapped into this 24-bit space. To achieve the maximum resolution possible in the 24 bits available, the graphics hardware maps the Z-distance between the Front and Back Clipping Planes into the 24 bits available. Hence, the larger the distance between the Z-Clip Planes, the lower the Z resolution, which can affect image quality for solid images. If you see problems with your solid images, move the front and back clipping planes in as close as possible.

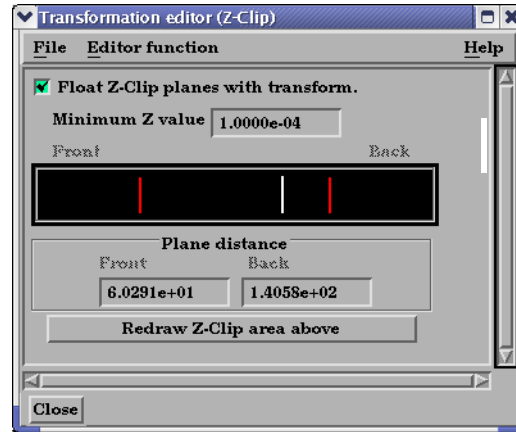

Figure 9-21  
Transformation Editor for Z-Clip Plane Positions

The Transformation Editor (Z-Clip) is used to adjust the distances of the Front and Back Clipping Planes from the Look-From Point.

<i>Float Z Clip Planes With Transform</i>	When on, will automatically adjust the front and back Z-Clip planes away from the model.
Minimum Z Value	Minimum distance the Front Clipping Plane is allowed to float to from the Look From Point (model coordinates). Used only if Float Z Clip Planes with Transform toggle is on.
<i>Z-Clip Area Display</i>	Displays position of Z-Clip planes relative to model-part Z-range (shown as a rectangle) and allows interactive positioning (by clicking and dragging) of the Z-Clip planes. If lines are inside model rectangle, that part of model is clipped from the display. Values update in data fields as you move sliders. Active viewports of the Main View update automatically as you move sliders.
<i>Plane Distance</i>	
Front	Distance of the Front Clipping Plane from Look From Point in model coordinates. Precisely specify by typing in desired distance and pressing Return. Not used if the Float Z Clip Planes With Transform toggle is on.
Back	Distance of the Back Clipping Plane from the Look From Point in model coordinates. Precisely specify by typing in desired distance and pressing Return. Not used if the Float Z Clip Planes With Transform toggle is on.
<i>Redraw</i>	The Plane Position Display does not automatically update if you perform transformations in the active viewport. Click this button to update the Plane Position Display.

### Troubleshooting Z-Clip Planes

Problem	Probable Causes	Solutions
Main View is empty	No parts located between Front and Back Z-Clip Planes.	Adjust Z-Clip plane locations
Model degenerates to irregular polygons or the front Z-Clip line is locked in the model extent box	You have moved the front Z-Clip plane too close to (or on) the Look From Point.	Move the front Z-Clip plane away from the Look From Point.

## 9.7 Look At/Look From

Using the Transformation Editor with Editor Function > Look At/Look From chosen, you can reposition the point from which you are observing the model (the Look From Point) and the point at which you are looking (the Look At Point). Both the Look-From and Look-At points are specified in the coordinates of the Model Frame (Frame 0).

Initially, the Look At Point is at the geometric center of the initial model parts read by the EnSight Client. The Look From Point is on the positive Z-axis at a distance appropriate to display the model in the Main View window.

If you increased only the X position of the Look From Point, in the Graphics Window (or selected Viewport), it would appear that the model had rotated about the Global Y axis. In fact, the model has not rotated at all, which is shown by the visible Global Axis triad in the figure below. What has happened is that you are now viewing the model from a position farther to the right than previously.

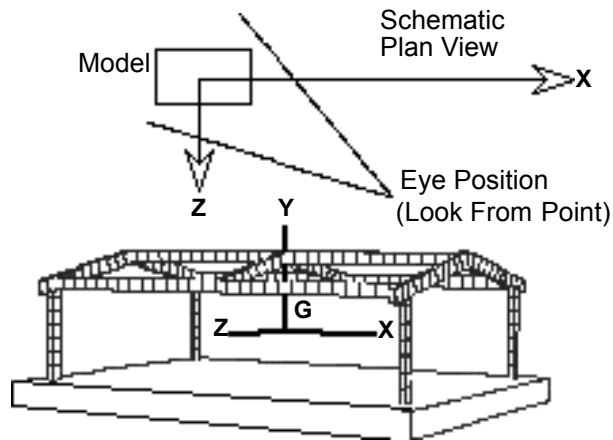

Figure 9-22  
Image showing view of model from negative X axis towards positive X axis

If the Y and Z coordinates of the Look From point were made to be the same as those of the Look At point, but the X coordinate of Look From point was specified as a much smaller value than that of the Look At point, it would appear in the Graphics Window (or selected Viewport) that the model had rotated 90 degrees about the Global Y axis. As before, the model has actually not rotated at all, which is shown by the visible Global Axis triad in the figure below. What has happened is that you are now viewing the model from a position on the negative Global X axis looking in the positive X direction.

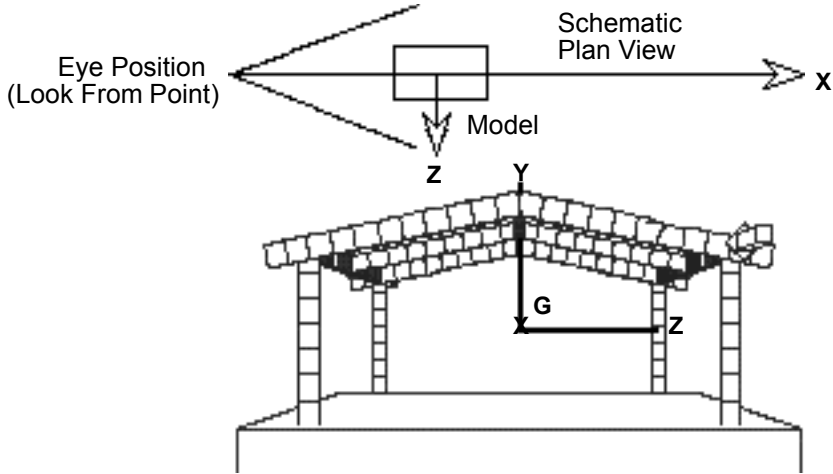

Figure 9-23  
Image showing view of model from negative X axis towards positive X axis

The position of the Look-At and Look-From points can be interactively or precisely specified using the Transformation Editor dialog with Editor Function > Look At/Look From.

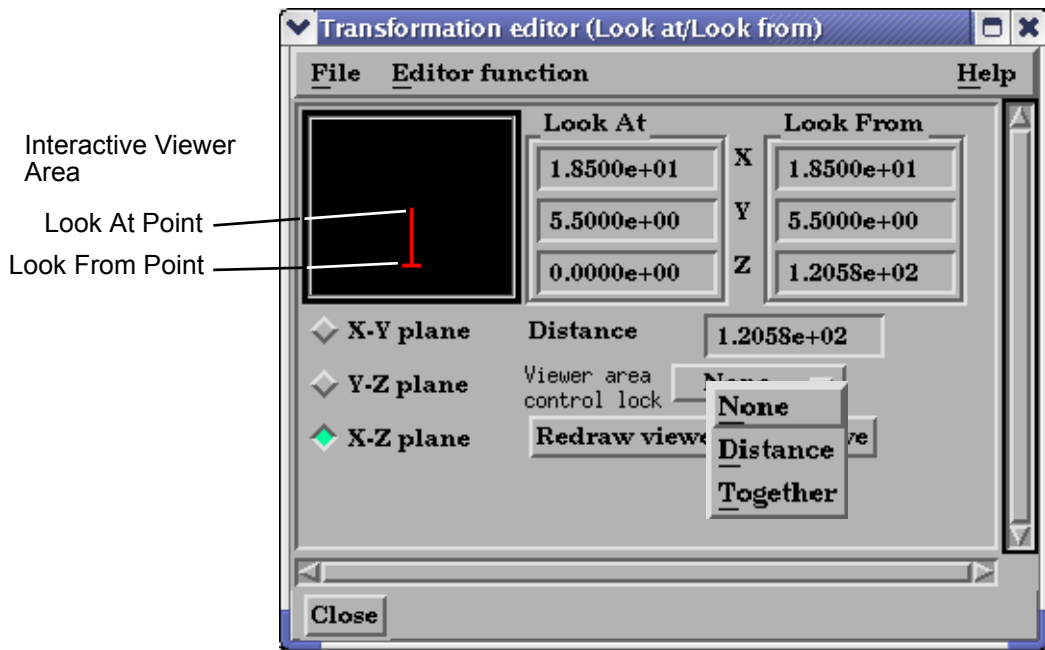

Figure 9-24  
Transformation Editor for Look At/Look From



<i>Interactive</i>	The position of the Look At and Look From Points may be positioned interactively in the Interactive Viewer Area by grabbing the Look At or Look From Point and dragging it to the desired location. These interactive modifications can be made in the X-Z Plane, the X-Y Plane, or the Y-Z Plane, depending upon which of the three toggles are selected. The Graphics Window as well as the Look At and Look From coordinate fields updates as you drag either Point to a new location.
<i>Precise</i>	The position of the Look At and Look From Points may be positioned precisely by specifying the desired coordinate values in the X Y Z fields and pressing Return.
Distance	The distance in model coordinates may be precisely specified by entering the desired value in this field and pressing Return.
Viewer Area Control Lock	Opens a pop-up menu for the selection of how interactive actions taken in the Viewer Area will be limited. Choices are: <i>None</i> No locks are applied <i>Distance</i> The distance between the two Points is locked <i>Together</i> The distance and direction vector between the two Points is locked
Redraw Viewer Area Above	This button redraws the Viewer Area. This button should be clicked after a transformation is performed in the selected viewport while this dialog is active.

## 9.8 Copy/Paste Transformation State

This transformation option can be used to apply the transformation state of one viewport to other viewports. Useful if you want multiple viewports to have the model oriented the same, and you did not link the viewports for transformations before applying any transformations.

The use of this option consists of:

1. Selecting the viewport (one only) containing the transformation state desired.  
*(You can do this in Vport mode in the graphics screen, or under Editor Function -> Global Transform in the Transformation Editor Dialog.)*
2. Selecting *Copy Transformation State* under Editor Function in the Transformation Editor dialog.
3. Selecting the one or more viewports to receive this transformation state.  
*(As in 1. above)*
4. Selecting *Paste Transformation State* under Editor Function in the Transformation Editor dialog.

# 10 Preference File Formats

This chapter provides information about the various file formats associated with different preference options within EnSight.

**Section 10.1, Window Position File Format** describes the format of the file which contains your saved window positions and sizes.

**Section 10.2, Connection Information File Format** describes the format of the file which contains your auto-connection information.

**Section 10.3, Palette File Formats** describes the format of the color selector palette, saved function palettes, and the default false color function palette.

**Section 10.4, Default Part Colors File Format** describes the file format for the default colors for parts.

**Section 10.5, Data Reader Preferences File Format** describes the format for the data reader preferences file.

**Section 10.6, Data Format Extension Map File Format** describes the format of the `ensight_reader_extension.map` file.

**Section 10.7, Parallel Rendering Configuration File** points to the location where the format of the parallel rendering configuration file is described.

## 10.1 Window Position File Format

To save a window position file, click Edit > Preferences... from the Main Menu and select the “General User Interface” option. Then select the Save Size and Position of Main Windows button. When you select this button, the current position of major dialog windows is saved to the `ensight8.winpos.default.XRESxYRES` file. In general, this file contains dialog position and size information, along with information about the states of the expandable sections of dialogs.

This file is normally saved to and read from the `.ensight8` directory of the users home directory. If the file is in the Client working directory it will be read from and saved to that directory instead.

Only major dialogs are affected; the miscellaneous pop-up dialogs are not specified. You do not have to include every dialog and every section listed. EnSight will process the ones provided.

### *Window File Format*

The format of the EnSight window position file is as follows:

- Line 1: Font Size  
Integer specifying font size for dialog labels.
- Lines 2 to N: Dialog Title, Size, & Location  
String: `[IntegerXInteger+]Integer+Integer` specifying  
Dialog title: Width x Height + Xloc + Yloc. The dialog title of each window can be shortened using the \* as a meta character. For example, the string title Transformation Editor: 0+815 can be shortened to \*Transform\*: 0+815. Be careful that your abbreviated name does not match any other names, or the position of all those names will be changed.
- Line N+1: List Separator String  
Character string `-Section Expansion Information-` to separate dialog size and location information from section-open information.
- Lines N+2 to End: Section Expansion Toggles  
Dialog->Section[->Section]: `open|closed` character strings indicating whether corresponding dialog section is open or closed.

The following is an example window position file:

```
fontsize: 13
EnSight: 910x984+369+31
Transformation Editor: 390x381+180+368
Command: 300x0+0+682
Connect Server: 137+0
Query Dataset: 0+0
```

## 10.2 Connection Information File Format

EnSight saves a file on the Client host system, called `ensight.connect.default` whenever you connect the Server via the auto connect feature. The next time you start EnSight, it will read this file and display your previous connection information. This file is normally saved to and read from the `.ensight8` directory of the users home directory. But, any local file will override this location process.

The complete ASCII text file contains the following Server and/or plotter system information.

```
server
machine SERVER_SYSTEM_ID
executable [SERVER_EXE_PATH/]ensight.server
directory SERVER_WORKING_DIRECTORY
login_id SERVER_LOGIN_ID
```

Each line of the file consists of a descriptive keyword that is usually followed by an appropriate system variable. The system variables are shown above with generic abbreviations in capital letters.

Keyword	Description
<code>server</code>	Denotes that following keywords and variables pertain to how the program <code>ensight8.server</code> is started via an automatic connection.
<code>machine</code>	The id or hostname of the system where the program is executed. This defaults to your Client host system hostname.
<code>executable</code>	The complete path to the executable program. This defaults to executing <code>ensight8.server</code> (which must be in your defined UNIX search path). This path is normally defined in your <code>.login</code> or <code>.cshrc</code> file in your home directory (for C shell users).
<code>directory</code>	The directory that you wish the Server to execute from on the Server host system. You may want to specify the directory that contains your data files on the Server host system. This defaults to your home directory on the (Server or plotter) host system for a distributed connection. It defaults to the Client's working directory when in standalone mode.
<code>login_id</code>	Your alternate login id on the Server host system. This defaults to your Client host system login id. (This option is only applicable to distributed connections).

## 10.3 Palette File Formats

The following palette formats are discussed in this section:

### Color Selector Palette File Format

### Function Palette File Format

### Predefined Function Palette

### Default False Color Map File Format

#### Color Selector Palette File Format

This file defines the colors that are used with the EnSight Color Selector. If EnSight does not find a definition file it uses a default palette. If, however, it does find a file (the file must be called `ensight.colpal.default` and be located in the `.ensight8` directory of the users home directory) at start-up it will read your colors and show them in the Color Selector.

The format of the `ensight.colpal.default` file is as follows:

- Line 1: “Version 6.0” (Note, this need not match EnSight’s version number.)
- Line 2 through Line 37

Three integers, one for each color (red, green, blue), ranging from 0 (no intensity) to 255 (full intensity).

#### Function Palette File Format

A function palette file is saved using the Function Editor when you save (one or more) function color palettes. The following is an example function palette file:

```
palette 'velocity'
variable_type vector
variable 'velocity'
type continuous
limit_fringes no
scale linear
number_of_levels 5
colors
0.000000 0.000000 1.000000
0.000000 1.000000 1.000000
0.000000 1.000000 0.000000
1.000000 1.000000 0.000000
1.000000 0.000000 0.000000
values
0.100341
0.301022
0.501704
0.702385
0.903067
```

Many lines of the file consists of a descriptive keyword followed by an appropriate value. In other areas the keyword is used to start a block of

information. The values are all free format real or integer numbers or string constants. The palette name must have single quotes around each name. The string keywords and constant values must match exactly.

Keyword	Description
palette	Name of the palette when one name is present. Name of the subpalette when two names are present (ex. palette 'velocity' 'xcomp')
variable	Name of the variable used with the palette.
variable_type	Type of the variable, scalar or vector.
type	Type of the palette, continuous or banded.
limit_fringes	Indicates if the palette is set up for limiting fringe. If it is, the options are <code>by_Part</code> or <code>by_invisible</code> .
scale	Indicates whether the palette scale is linear, logarithmic, or quadratic.
number_of_levels	Indicates the number of levels defined for the palette.
colors	Indicates the start of a block of RGB triplets, 1 triplet per line. There will be the same number of lines as there are levels.
values	Indicates the start of a block of level values. There will be the same number of values as there are levels.

## Predefined Function Palette

When EnSight starts, it looks for user defined function color palettes located under `$CEI_HOME/ensight74/site_preferences/palettes` and in the `.ensight8/palettes` directory found in the user's home directory. These files must be named `palette_name.cpal`, where the `palette_name` is the name of the color palette in the Simple Interface area of the function dialog.

The format of the `.cpal` file is as follows:

- Line 1: The string "`number_of_levels x`", where `x` is an integer.
- Line 2: The string "`colors`"
- Line 3 through `x + 2`: Three float values in range 0.0 to 1.0, indicating red, green, and blue color components.

An example color palette file:

```
number_of_levels 5
colors
.008 0. 0.
.5 0. 0.
1. 0. 0.
1. 1. 0.
1. 0. 1.
```

## Default False Color Map File Format

This file defines the default false-color map color range that is assigned by EnSight to each palette when variables are activated. If EnSight does not find a definition file, it uses an internal default list. If, however, EnSight does find a file (the file must be called `ensight.false_color.default` and be located in the `.ensight8` directory of the user's home directory or be located in `$CEI_HOME/ensight80/site_preferences`) at start-up, EnSight will read your colors as the default palette colors.

The format of the `ensight.false_color.default` file is as follows:

- Line 1: "Version 6.0" (Note, this need not match EnSight's version number.)
- Line 2: One integer, the number default false color map colors
- Line 3 on: three floats (each ranging between 0. and 1.), the (red, green, blue) color triplet of each color, each listed on separate lines.

An example default file can be found in:

```
$CEI_HOME/ensight80/site_preferences/ensight.false_color.default
```

on your client system.

The following is an example default false color map file with 5 colors; blue, cyan, green, yellow, and red:

```
Version 6.0
5
0. 0. 1.
0. 1. 1.
0. 1. 0.
1. 1. 0.
1. 0. 0.
```



## 10.4 Default Part Colors File Format

This file defines default Constant Colors that are assigned (and cycled through) by EnSight when parts are built. If EnSight does not find a definition file it uses an internal default list. If, however, EnSight does find a file (the file must be called `ensight.part.colors.default` and be located in the `.ensight8` directory of the user's home directory or be located in `$CEI_HOME/ensight80/site_preferences`) at start-up, EnSight will read your colors as the default Constant Colors.

The format of the `ensight.part.colors.default` file is as follows:

- Line 1: "Version 6.0" (Note, this need not match EnSight's version number.)
- Line 2: One integer, the number of default part colors
- Line 3 on: three floats (each ranging between 0. and 1.), the (red, green, blue) color triplet of each color, each listed on separate lines.

An example default file can be found in:

```
$CEI_HOME/ensight80/site_preferences/ensight.part.colors.default
```

on your client system.

The following is an example default part colors file with 6 colors (blue, cyan, green, yellow, red, and magenta):

```
Version 6.0
6
0. 0. 1.
0. 1. 1.
0. 1. 0.
1. 1. 0.
1. 0. 0.
1. 0. 1.
```

## 10.5 Data Reader Preferences File Format

This is an optional file that will be created when the user saves preferences under Main Menu > Edit > Preferences... Data. It can contain two basic things: 1) the reader name desired to be the default Format in the Data Reader dialog, and/or 2) any reader names that the user does NOT want to appear in the Format list. The default data Format will be “Case” unless this file exists and overrides it. Also, by default, all readers will appear in the list of available reader Formats unless specifically set to be removed in this file. The file must be called `ensight_reader_prefs.def` and be located in the `.ensight8` directory of the user’s home directory or be located in `$CEI_HOME/ensight80/site_preferences`.

The format of the `ensight_readers_prefs.def` file is as follows:

- Line 1: "Version 7.1" (Note, this need not match EnSight’s version number.)
- Line 2: “select *readername*” Where *readername* is the name of the reader that will be used as the default
- Line 3 on: “remove *readername*” Where *readername* is the name of a reader that will NOT be shown in the data reader Format list.

The following is an example data reader preferences file which sets EnSight 5 as the default Format, and causes the Movie, MPGS 4.1, and the SCRYU readers to NOT be available in the list.

```
Version 7.1
select Enight 5
remove Movie
remove MPGS 4.1
remove SCRYU
```

## 10.6 Data Format Extension Map File Format

The `ensight_reader_extension.map` file is used to associate file suffixes with a reader within EnSight. This association allows EnSight to use the Quick load method of reading data. See [Section 2.1, Reader Basics](#) or [How To Read Data](#)

A default version of this file is provided with the EnSight distribution and is placed in the `$CEI_HOME/ensight80/site_preferences` directory. A user can override this file by placing his own version of the file in his `.ensight8` directory of his home directory.

A description of the format is contained in the file itself. A portion of the file is given below (it contains only a few file formats, but it should be easy to see how this file is formatted).

```
EnSight file extension to format association file
Version 1.0
#
# Comment lines start with a #
#
#
# The format of this file is as follows:
#
# READER_NAME: reader name as it appears in the Format chooser in the
#               EnSight Data Reader dialog
#
# NUM_FILE_1: the number of file_1_ext lines to follow
#
# FILE_1_EXT: the extension that follows a file name minus the ".", i.e.,
#             "geo", "case", etc.
#             There should be one definition after the :. Multiple
#             FILE_1_EXT lines may exist
#
# NUM_FILE_2: the number of file_2_ext lines to follow
#
# FILE_2_EXT: the extension of a second file that will act as the result
#             file. This is only used for formats that require two file
#             names. As with FILE_1_EXT, there may be multiple
#             FILE_2_EXT lines.
#
# ELEMENT_REP: A key word that describes how the parts will be loaded
#             (all parts will be loaded the same way).
#             One of the following:
#                 "3D border, 2D full"
#                 "3D feature, 2D full"
#                 "3D nonvisual, 2D full"
#                 "Border"
#                 "Feature angle"
#                 "Bounding Box"
#                 "Full"
#                 "Non Visual"
#             If option is not set then 3D border, 2D full is used
#
# READ_BEFORE: (optional) The name of a command file to play before reading
#             the file(s)
#
```

## 10.6 Data Format Extension Map File Format

```
#
# READ_AFTER: (optional) The name of a command file to read after loading
#               the parts

# Definition for Case files

READER_NAME: Case
NUM_FILE_1: 2
FILE_1_EXT: case
FILE_1_EXT: encas
ELEMENT_REP: 3D feature, 2D full

# Definition for EnSight5 files

READER_NAME: EnSight 5
NUM_FILE_1: 2
FILE_1_EXT: geo
FILE_1_EXT: GEOM
NUM_FILE_2: 2
FILE_2_EXT: res
FILE_2_EXT: RESULTS
ELEMENT_REP: 3D feature, 2D full

# Definition for STL files

READER_NAME: STL
NUM_FILE_1: 2
FILE_1_EXT: stl
FILE_1_EXT: STL
ELEMENT_REP: 3D feature, 2D full

# Definition for Dytran files

READER_NAME: MSC/Dytran
NUM_FILE_1: 2
FILE_1_EXT: dat
FILE_1_EXT: ARC
ELEMENT_REP: 3D border, 2D full
READ_AFTER: ~/.ensight8/read_after_dytran.cmd
```

## 10.7 Parallel Rendering Configuration File

The format of the configuration file for parallel rendering is described in detail in [Section 13, Parallel Rendering and Virtual Reality](#).



# 11 EnSight Data Formats

This section describes the format for all readable and writable files in EnSight which you may need access to. The formats described are only for those files that are specific to EnSight. We do not describe data formats not developed by CEI (for example, data formats for various analysis codes). For information about these formats, consult the applicable creator.

*Note:* If you are using this documentation to produce your own data translator, please make sure that you follow the instructions exactly as specified. In many cases, EnSight reads data in blocks to improve performance. If the format is not followed, the calculations of how much to read for a block will be thrown off. EnSight does little in the way of error checking data files when they are read. In this respect, EnSight sacrifices robustness for performance.

## EnSight Formats

EnSight has three evolutionary file formats listed below from oldest to most recent:

### EnSight 5

- legacy format
- supported unstructured meshes only
- used a global nodal array
- used per node variables only

### EnSight 6

- support for case file
- support for both unstructured and structured meshes
- uses a global nodal array
- use per node or per element variables

### EnSight Case Gold (recommended format)

- is much faster than EnSight 6 and is more memory efficient (noticeable if you have a large number of parts or for larger models)
- uses connectivity which can be separate from the node ids
- uses a part basis rather than a global array

### Format illustration

#### EnSight Case Gold

---

**part 1**  
node coordinates  
element connectivity by local node index

**part 2**  
node coordinates  
element connectivity by local node index

...

**part n**  
node coordinates  
element connectivity by local node index

#### EnSight 6

---

global nodal ids & coordinates

**part 1**  
element connectivity by global node ids

**part 2**  
element connectivity by global node ids

...

**part n**  
element connectivity by global node ids

## *Saving Gold from EnSight*

EnSight can export your model into Case Gold format (either ASCII or Binary). Activate the variables of interest, select the parts in the main part window and then go to the File menu: File->Save->Geometric Entities.

## *Tool to Check EnSight Format*

There is another advantage to using Case Gold format in that there is a debugging tool called `ens_checker` that can help you find mistakes in files as you write a translator or exporter. Just type `ens_checker file.case` and the code will echo it's progress and the problems it finds to the console. This tool will also check EnSight 6 format.

## *Detailed Description of Formats*

**Section 11.1, EnSight Gold Casefile Format** describes in detail the EnSight Gold case, geometry, and variable file formats. *This format provides the best performance for getting data into EnSight. It is readable by both the EnSight and EnSight Gold programs.*

**Section 11.2, EnSight6 Casefile Format** describes in detail the EnSight6 case, geometry, and variable file formats. *This format is still supported, but is a legacy format. It has most, but not all, of the options of the gold format - and is somewhat lower in performance.*

**Section 11.3, EnSight5 Format** describes in detail the EnSight5 geometry and variable file formats. *This format is still supported, but is a legacy format. It is for unstructured data only.*

**Section 11.4, FAST UNSTRUCTURED Results File Format** describes the “executive” .res file that can be used with FAST unstructured solution and function files.

**Section 11.5, FLUENT UNIVERSAL Results File Format** describes the “executive” .res file that can be used with FLUENT Universal files for transient models.

**Section 11.6, Movie.BYU Results File Format** describes the “executive” .res file that can be used with Movie.BYU files.

**Section 11.7, PLOT3D Results File Format** describes the “executive” .res file that can be used with PLOT3D solution and function files.

**Section 11.8, Server-of-Server Casefile Format** describes the format of the casefile used with the server-of-server capability of EnSight.

**Section 11.9, Periodic Matchfile Format** describes the format of the file which can be used to explicitly specify which nodes match from one periodic instance to the next.

**Section 11.10, XY Plot Data Format** describes the format of the file containing XY plot data.

**Section 11.11, EnSight Boundary File Format** describes the format of the file which can define unstructured boundaries of structured data.

**Section 11.12, EnSight Particle Emitter File Format** describes the format of the optional file containing particle trace emitter time and location information.



# 11.1 EnSight Gold Casefile Format

Include in this section:

**EnSight Gold General Description**

**EnSight Gold Geometry File Format**

**EnSight Gold Case File Format**

**EnSight Gold Wild Card Name Specification**

**EnSight Gold Variable File Format**

**EnSight Gold Per\_Node Variable File Format**

**EnSight Gold Per\_Element Variable File Format**

**EnSight Gold Undefined Variable Values Format**

**EnSight Gold Partial Variable Values Format**

**EnSight Gold Measured/Particle File Format**

**EnSight Gold Material Files Format**

## *EnSight Gold General Description*

EnSight Gold data consists of the following files:

- Case (required) (points to all other needed files including model geometry, variables, and possibly measured geometry and variables)

EnSight makes no assumptions regarding the physical significance of the scalar, vector, 2nd order symmetric tensor, and complex variables. These files can be from any discipline. For example, the scalar file can include such things as pressure, temperature, and stress. The vector file can be velocity, displacement, or any other vector data, etc.

In addition, EnSight Gold format handles "undefined" as well as "partial" variable values. (See appropriate subsections later in this chapter for details.)

All variable results for EnSight Gold format are contained in disk files—one variable per file. Additionally, if there are multiple time steps, there must either be a set of disk files for each time step (transient multiple-file format), or all time steps of a particular variable or geometry in one disk file each (transient single-file format).

Sources of EnSight Gold format data include the following:

- Data that can be translated to conform to the EnSight Gold data format (including being written from EnSight itself using the Save Geometric Entities option under File->Save)
- Data that originates from one of the translators supplied with the EnSight application

The EnSight Gold format supports an unstructured defined element set as shown in the figure on a following page. Unstructured data must be defined in this element set. Elements that do not conform to this set must either be subdivided or

discarded.

The EnSight Gold format also supports the same structured block data format as EnSight6, which is very similar to the PLOT3D format. *Note that for this format, the standard order of nodes is such that I's advance quickest, followed by J's, and then K's.*

A given EnSight Gold model may have either unstructured data, structured data, or a mixture of both.

This format is somewhat similar to the EnSight6 format, but differs enough to allow for more efficient reading of the data. It is intended for **3D, binary, big** data models.

*Note: While an ASCII format is available, it is not intended for use with large models and is in fact subject to limitations such as integer lengths of 10 digits. Use the binary format if your model will exceed 10 digits for node or element numbers or labels.*

Starting with version 7, EnSight writes out all model and variable files in EnSight Gold format. Thus, it can be read by all version 7 or 8 EnSight licenses (i.e. standard, gold, and custom licenses).

### *ens\_checker*

A program is supplied with EnSight which attempts to verify the integrity of the *format* of EnSight 6 and EnSight Gold files. If you are producing EnSight formatted data, this program can be very helpful, especially in your development stage, in making sure that you are adhering to the published format. It makes no attempt to verify the validity of floating point values, such as coordinates, variable values, etc. This program takes a casefile as input. Thus, it will check the format of the casefile, and all associated geometry and variable files referenced in the casefile. See [How To Use ens\\_checker](#).

*Supported EnSight Gold Elements*

The elements that are supported by the EnSight Gold format are:

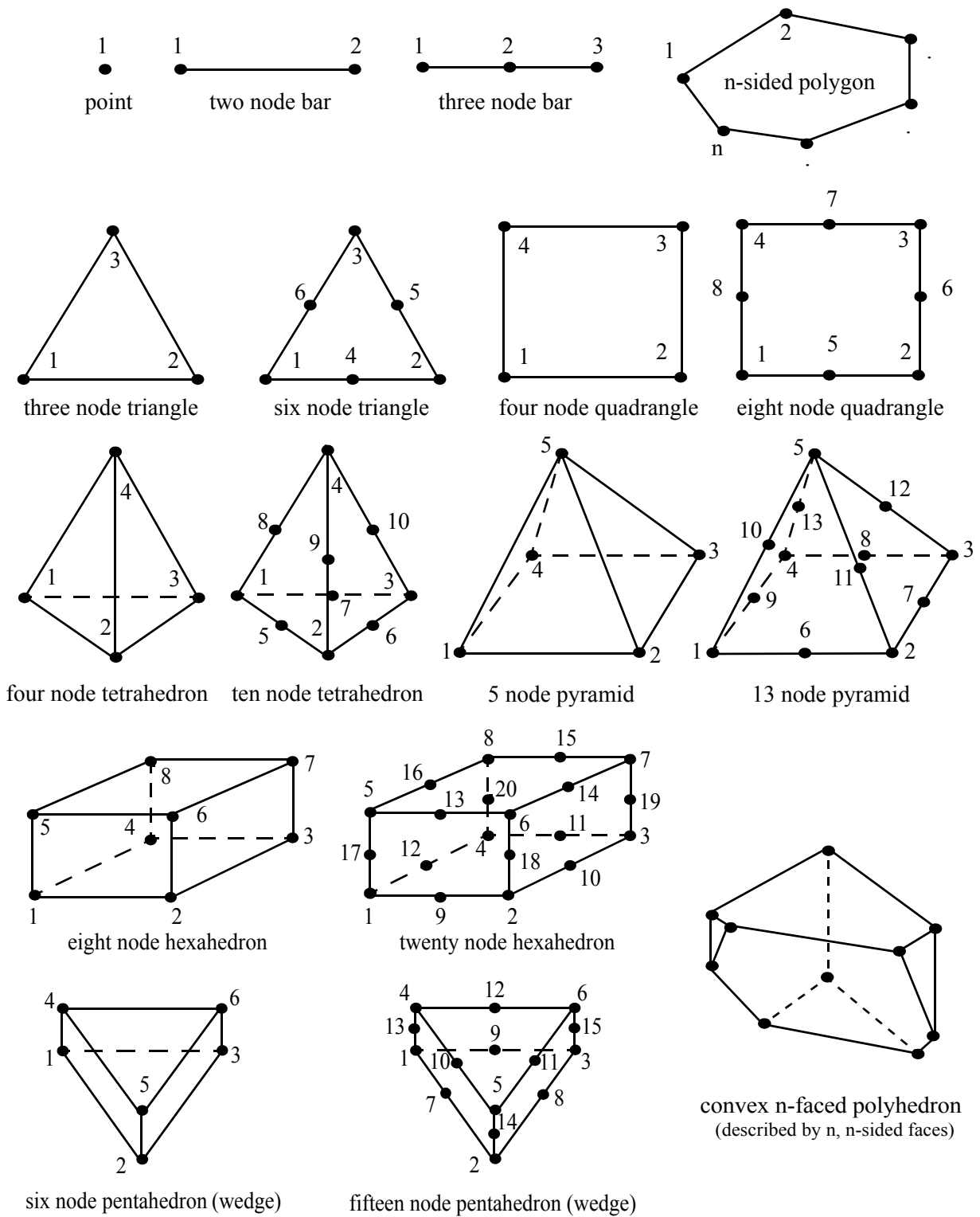

Figure 11-1  
Supported EnSight Gold Elements

## EnSight Gold Geometry File Format

The EnSight Gold format is part based for both unstructured and structured data. There is no global coordinate array that each part references, but instead - each part contains its own local coordinate array. Thus, the node numbers in element connectivities refer to the coordinate array index, not a node id or label. *This is different than the EnSight6 format!*

The EnSight Gold format consists of keywords followed by information. The following items are important when working with EnSight Gold geometry files:

1. Node ids are optional. In this format they are strictly labels and are not used in the connectivity definition. The element connectivities are based on the local implied node number of the coordinate array in each part, which is sequential starting at one. If you let EnSight assign node IDs, this implied internal numbering is used. If node IDs are set to off, they are numbered internally, however, you will not be able to display or query on them. If you have node IDs given in your data, you can have EnSight ignore them by specifying “node id ignore.” Using this option may reduce some of the memory taken up by the Client and Server, but display and query on the nodes will not be available. Note, prior to EnSight 7.4, node ids could only be specified for unstructured parts. This restriction has been removed and user specified node ids are now possible for structured parts.
2. Element ids are optional. If you specify element IDs, or you let EnSight assign them, you can show them on the screen. If they are set to off, you will not be able to show or query on them. If you have element IDs given in your data you can have EnSight ignore them by specifying “element id ignore.” Using this option will reduce some of the memory taken up by the Client and Server. This may or may not be a significant amount, and remember that display and query on the elements will not be available. Note, prior to EnSight 7.4, element ids could only be specified for unstructured parts. This restriction has been removed and user specified element ids are now possible for structured parts.
3. Model extents can be defined in the file so EnSight will not have to determine these while reading in data. If they are not included, EnSight will compute them, but will not actually do so until a dataset query is performed the first time.
4. The format of integers and real numbers **must be followed** (See the Geometry Example below).
5. ASCII Integers are written out using the following integer format:

From C:                                   10d format

From FORTRAN:                           i10 format

*Note: this size of integer format places a limitation on the number of nodes and the node and element labels that can make up a model. Use the binary format for large models!*

ASCII Real numbers are written out using the following floating-point format:

From C:                                   12.5e format

From FORTRAN:                           e12.5 format

**The number of integers or reals per line must also be followed!**

6. By default, a Part is processed to show the outside boundaries. This representation is loaded to the Client host system when the geometry file is read (unless other attributes have been set on the workstation, such as feature angle).
7. Coordinates for unstructured data must be defined within each part. This is normally done before any elements are defined within a part, but does not have to be. The different elements can be defined in any order (that is, you can define a hexa8 before a bar2).
8. A Part containing structured data cannot contain any unstructured element types or more than one block. **Each structured Part is limited to a single block (or some subset of that block).** A structured block is indicated by following the Part description line with a 'block' line. By default, a block will be curvilinear, non-iblancked, non-ghost, complete range. However, by suppling one or more of the following options on the 'block' line, rectilinear or uniform blocks can be specified, nodal iblanking for the block can be used, cells within the block can be flagged as ghosts (used for computations, but not displayed), subset ranges can be specified (useful for partitioned data). The options include:

<b>Only one of these can be used on the 'block' line</b>	
curvilinear	Indicates that coordinates of all ijk locations of the block will be specified (default)
rectilinear	Indicates that i,j,k delta vectors for a regular block with possible non-regular spacing will be specified
uniform	Indicates that i,j,k delta values for a regular block with regular spacing will be specified
<b>Any, none, or all of these can be used</b>	
iblancked	An "iblancked" block must contain an additional integer array of values at each node, traditionally called the iblanck array. Valid iblanck values for the EnSight Gold format are:
0	for nodes which are exterior to the model, sometimes called blancked-out nodes
1	for nodes which are interior to the model, thus in the free stream and to be used
<0 or >1	for any kind of boundary nodes
	In EnSight's structured Part building dialog, the iblanck option selected will control which portion of the structured block is "created". Thus, from the same structured block, the interior flow field part as well as a symmetry boundary part could be "created".  <i>Note: By default EnSight does not do any "partial" cell iblanck processing. Namely, only complete cells containing no "exterior" nodes are created. It is possible to obtain partial cell processing by issuing the "test:partial_cells_on" command in the Command Dialog before reading the file.</i>

with_ghost	A block with ghosts must contain an additional integer array of flags for each cell. A flag value of zero indicates a non-ghost cell. A flag value of non-zero indicates a ghost cell.
range	<p>A block with ranges will contain an extra line, following the ijk line, which gives min and max planes for each of the ijk directions.</p> <p>Thus, normally a 6 x 5 x 1 block part would start something like:</p> <pre> part   1 description block   6   5   1   0.00000e+00 ... </pre> <p>(The coordinate information for the 30 nodes of the block must follow.)</p> <p>But if only the top 6 x 3 x 1 portion was to be represented in the file, you can use “range” like:</p> <pre> part   1 description for top only block range   6   5   1   1   6   3   5   1   1   0.00000e+00 ... </pre> <p>(The coordinate information for the 18 nodes of the top portion of the block must follow. Note that the ijk line following the block line contains the size of the original block - which is needed to properly deal with node and element numbering. The next line contains the imin, imax, jmin, jmax, kmin, kmax defining the subset ranges. The actual size of the block being defined is thus computed from these ranges:</p> <pre> size_i = imax - imin + 1 size_j = jmax - jmin + 1 size_k = kmax - kmin + 1 </pre>

*Note that for structured data, the standard order of nodes is such that I's advance quickest, followed by J's, and then K's.*

*Generic Format*

## Usage Notes:

In general an unstructured part can contain several different element types.

element type can be any of:

point	g_point
bar2	g_bar2
bar3	g_bar3
tria3	g_tria3
tria6	g_tria6
quad4	g_quad4
quad8	g_quad8
tetra4	g_tetra4
tetra10	g_tetra10
pyramid5	g_pyramid5
pyramid13	g_pyramid13
penta6	g_penta6
penta15	g_penta15
hexa8	g_hexa8
hexa20	g_hexa20
nsided	g_nsided
nfaced	g_nfaced

# = a part number

nn = total number of nodes in a part

ne = number of elements of a given type

np = number of nodes per element for a given element type

nf = number of faces per nfaced element

id\_\* = node or element id number

x\_\* = x component

y\_\* = y component

z\_\* = z component

n\*\_e\* = node number for an element

f\*\_e\* = face number for an nfaced element

ib\_\* = iblanking value

gf\_e\*= ghost flag for a structured cell

[ ] contain optional portions

< > contain choices

` indicates the beginning of an unformatted sequential FORTRAN binary write

' indicates the end of an unformatted sequential FORTRAN binary write

**C Binary form:**

C Binary	80 chars
description line 1	80 chars
description line 2	80 chars
node id <off/given/assign/ignore>	80 chars
element id <off/given/assign/ignore>	80 chars
[extents	80 chars
xmin xmax ymin ymax zmin zmax]	6 floats
part	80 chars
#	1 int
description line	80 chars
coordinates	80 chars
nn	1 int
[id_n1 id_n2 ... id_nn]	nn ints
x_n1 x_n2 ... x_nn	nn floats
y_n1 y_n2 ... y_nn	nn floats
z_n1 z_n2 ... z_nn	nn floats
element type	80 chars
ne	1 int
[id_e1 id_e2 ... id_ne]	ne ints
n1_e1 n2_e1 ... np_e1	
n1_e2 n2_e2 ... np_e2	
.	
.	
n1_ne n2_ne ... np_ne	ne*np ints
element type	80 chars
.	
.	
part	80 chars
.	
.	
part	80 chars
#	1 int
description line	80 chars
block [iblancked] [with_ghost] [range]	80 chars
i j k # nn = i*j*k, ne = (i-1)*(j-1)*(k-1)	3 ints
[imin imax jmin jmax kmin kmax] # if range used:	6 ints
	$nn = (imax-imin+1) * (jmax-jmin+1) * (kmax-kmin+1)$
	$ne = (imax-imin) * (jmax-jmin) * (kmax-kmin)$
x_n1 x_n2 ... x_nn	nn floats
y_n1 y_n2 ... y_nn	nn floats
z_n1 z_n2 ... z_nn	nn floats
[ib_n1 ib_n2 ... ib_nn]	nn ints
[ghost_flags]	80 chars
[gf_e1 gf_e2 ... gf_ne]	ne ints
[node_ids]	80 chars
[id_n1 id_n2 ... id_nn]	nn ints
[element_ids]	80 chars
[id_e1 id_e2 ... id_ne]	ne ints
part	80 chars
#	1 int
description line	80 chars
block rectilinear [iblancked] [with_ghost] [range]	80 chars
i j k # nn = i*j*k, ne = (i-1)*(j-1)*(k-1)	3 ints
[imin imax jmin jmax kmin kmax] # if range used:	6 ints
	$nn = (imax-imin+1) * (jmax-jmin+1) * (kmax-kmin+1)$
	$ne = (imax-imin) * (jmax-jmin) * (kmax-kmin)$
x_1 x_2 ... x_i	i floats
y_1 y_2 ... y_j	j floats



z_1 z_2 ... z_k	k floats
[ib_n1 ib_n2 ... ib_nn]	nn ints
[ghost_flags]	80 chars
[gf_e1 gf_e2 ... gf_ne]	ne ints
[node_ids]	80 chars
[id_n1 id_n2 ... id_nn]	nn ints
[element_ids]	80 chars
[id_e1 id_e2 ... id_ne]	ne ints
part	80 chars
#	1 int
description line	80 chars
block uniform [iblancked] [with_ghost] [range]	80 chars
i j k # nn = i*j*k, ne = (i-1)*(j-1)*(k-1)	3 ints
[imin imax jmin jmax kmin kmax] # if range used:	6 ints
	$nn = (imax-imin+1) * (jmax-jmin+1) * (kmax-kmin+1)$
	$ne = (imax-imin) * (jmax-jmin) * (kmax-kmin)$
x_origin y_origin z_origin	3 floats
x_delta y_delta z_delta	3 floats
[ib_n1 ib_n2 ... ib_nn]	nn ints
[ghost_flags]	80 chars
[gf_e1 gf_e2 ... gf_ne]	ne ints
[node_ids]	80 chars
[id_n1 id_n2 ... id_nn]	nn ints
[element_ids]	80 chars
[id_e1 id_e2 ... id_ne]	ne ints

**Fortran Binary form:**

'Fortran Binary'	
'description line 1'	80 chars
'description line 2'	80 chars
'node id <off/given/assign/ignore>'	80 chars
'element id <off/given/assign/ignore>'	80 chars
['extents'	80 chars
'xmin xmax ymin ymax zmin zmax']	6 floats
'part'	80 chars
'#'	1 int
'description line'	80 chars
'coordinates'	80 chars
'nn'	1 int
['id_n1 id_n2 ... id_nn']	nn ints
'x_n1 x_n2 ... x_nn'	nn floats
'y_n1 y_n2 ... y_nn'	nn floats
'z_n1 z_n2 ... z_nn'	nn floats
'element type'	80 chars
'ne'	1 int
['id_e1 id_e2 ... id_ne']	ne ints
'n1_e1 n2_e1 ... np_e1	
n1_e2 n2_e2 ... np_e2	
.	
.	
n1_ne n2_ne ... np_ne'	ne*np ints
'element type'	80 chars
.	
.	
'part'	80 chars
.	
.	
'part'	80 chars

```

`#` 1 int
`description line` 80 chars
`block [iblanke] [with_ghost] [range]` 80 chars
`i j k` # nn = i*j*k, ne = (i-1)*(j-1)*(k-1) 3 ints
`[imin imax jmin jmax kmin kmax]` # if range used: 6 ints
nn = (imax-imin+1) * (jmax-jmin+1) * (kmax-kmin+1)
ne = (imax-imin) * (jmax-jmin) * (kmax-kmin)

`x_n1 x_n2 ... x_nn` nn floats
`y_n1 y_n2 ... y_nn` nn floats
`z_n1 z_n2 ... z_nn` nn floats
`[ib_n1 ib_n2 ... ib_nn]` nn ints
`[ghost_flags]` 80 chars
`[gf_e1 gf_e2 ... gf_ne]` ne ints
`[node_ids]` 80 chars
`[id_n1 id_n2 ... id_nn]` nn ints
`[element_ids]` 80 chars
`[id_e1 id_e2 ... id_ne]` ne ints
`part` 80 chars
`#` 1 int
`description line` 80 chars
`block rectilinear [iblanke] [with_ghost] [range]` 80 chars
`i j k` # nn = i*j*k, ne = (i-1)*(j-1)*(k-1) 3 ints
`[imin imax jmin jmax kmin kmax]` # if range used: 6 ints
nn = (imax-imin+1) * (jmax-jmin+1) * (kmax-kmin+1)
ne = (imax-imin) * (jmax-jmin) * (kmax-kmin)

`x_1 x_2 ... x_i` i floats
`y_1 y_2 ... y_j` j floats
`z_1 z_2 ... z_k` k floats
`[ib_n1 ib_n2 ... ib_nn]` nn ints
`[ghost_flags]` 80 chars
`[gf_e1 gf_e2 ... gf_ne]` ne ints
`[node_ids]` 80 chars
`[id_n1 id_n2 ... id_nn]` nn ints
`[element_ids]` 80 chars
`[id_e1 id_e2 ... id_ne]` ne ints
`part` 80 chars
`#` 1 int
`description line` 80 chars
`block uniform [iblanke] [with_ghost] [range]` 80 chars
`i j k` # nn = i*j*k, ne = (i-1)*(j-1)*(k-1) 3 ints
`[imin imax jmin jmax kmin kmax]` # if range used: 6 ints
nn = (imax-imin+1) * (jmax-jmin+1) * (kmax-kmin+1)
ne = (imax-imin) * (jmax-jmin) * (kmax-kmin)

`x_origin y_origin z_origin` 3 floats
`x_delta y_delta z_delta` 3 floats
`[ib_n1 ib_n2 ... ib_nn]` nn ints
`[ghost_flags]` 80 chars
`[gf_e1 gf_e2 ... gf_ne]` ne ints
`[node_ids]` 80 chars
`[id_n1 id_n2 ... id_nn]` nn ints
`[element_ids]` 80 chars
`[id_e1 id_e2 ... id_ne]` ne ints

```

**ASCII form:**

```

description line 1 A (max of 79 typ)
description line 2 A
node id <off/given/assign/ignore> A
element id <off/given/assign/ignore> A

```

```

[extents                                     A
xmin xmax                                  2E12.5
ymin ymax                                  2E12.5
zmin zmax]                                 2E12.5
part                                         A
#                                             I10
description line                             A
coordinates                                  A
nn                                             I10
[id_n1                                       I10   1/line (nn)
 id_n2
 .
 .
 id_nn]
x_n1                                         E12.5 1/line (nn)
x_n2
 .
 .
x_nn
y_n1                                         E12.5 1/line (nn)
y_n2
 .
 .
y_nn
z_n1                                         E12.5 1/line (nn)
z_n2
 .
 .
z_nn
element type                                 A
ne                                             I10
[id_e1                                       I10   1/line (ne)
 id_e2
 .
 .
 id_ne]
n1_e1 n2_e1 ... np_e1                       I10   np/line
n1_e2 n2_e2 ... np_e2                       (ne lines)
 .
 .
n1_ne n2_ne ... np_ne
element type                                 A
 .
 .
part                                         A
 .
 .
part                                         A
#                                             I10
description line                             A
block [iblancked] [with_ghost] [range]      A
i j k # nn = i*j*k, ne = (i-1)*(j-1)*(k-1)  3I10
[imin imax jmin jmax kmin kmax] # if range used: 6I10
nn = (imax-imin+1)*(jmax-jmin+1)*(kmax-kmin+1)
ne = (imax-imin)*(jmax-jmin)*(kmax-kmin)
x_n1                                         E12.5 1/line (nn)
x_n2
 .
 .
x_nn
y_n1                                         E12.5 1/line (nn)

```

## 11.1 EnSight Gold Geometry File Format

```

y_n2
.
.
y_nn
z_n1          E12.5  1/line (nn)
z_n2
.
.
z_nn
[ib_n1        I10    1/line (nn)
 ib_n2
.
.
 ib_nn]
[ghost_flags] 80 chars
[gf_e1        I10    1/line (ne)
 gf_e2
.
.
 gf_ne]
[node_ids]    80 chars
[id_n1        I10    1/line (nn)
 id_n2
.
.
 id_nn]
[element_ids] 80 chars
[id_e1        I10    1/line (ne)
 id_e2
.
.
 id_ne]
part          A
#             I10
description line A
block rectilinear [iblanke] [with_ghost] [range] A
i j k          # nn = i*j*k, ne = (i-1)*(j-1)*(k-1) 3I10
[imin imax jmin jmax kmin kmax] # if range used: 6I10
                nn = (imax-imin+1)*(jmax-jmin+1)*(kmax-kmin+1)
                ne = (imax-imin)*(jmax-jmin)*(kmax-kmin)
x_1           E12.5  1/line (i)
x_2
.
.
x_i
y_1           E12.5  1/line (j)
y_2
.
.
y_j
z_1           E12.5  1/line (k)
z_2
.
.
z_k
[ib_n1        I10    1/line (nn)
 ib_n2
.
.
 ib_nn]
[ghost_flags] 80 chars

```

```

[gf_e1          I10   1/line (ne)
gf_e2
.
.
gf_ne]
[node_ids]      80 chars
[id_n1         I10   1/line (nn)
id_n2
.
.
id_nn]
[element_ids]   80 chars
[id_e1         I10   1/line (ne)
id_e2
.
.
id_ne]
part           A
#             I10
description line A
block uniform [iblanke] [with_ghost] [range] A
i j k          # nn = i*j*k, ne = (i-1)*(j-1)*(k-1) 3I10
[imin imax jmin jmax kmin kmax] # if range used: 6I10
nn = (imax-imin+1) * (jmax-jmin+1) * (kmax-kmin+1)
ne = (imax-imin) * (jmax-jmin) * (kmax-kmin)

x_origin      E12/5
y_origin      E12/5
z_origin      E12/5
x_delta       E12.5
y_delta       E12.5
z_delta       E12.5
[ib_n1        I10   1/line (nn)
ib_n2
.
.
ib_nn]
[ghost_flags] 80 chars
[gf_e1        I10   1/line (ne)
gf_e2
.
.
gf_ne]
[node_ids]      80 chars
[id_n1         I10   1/line (nn)
id_n2
.
.
id_nn]
[element_ids]   80 chars
[id_e1         I10   1/line (ne)
id_e2
.
.
id_ne]

```

## Notes:

- If `node id` is given or ignore, the `[id]` section must be there for each part.
- If `element id` is given or ignore, the `[id]` section must be there for each element type of each part
- If `iblancked` is there, the `[ib]` section must be there for the block.
- `x`, `y`, and `z` coordinates are mandatory, even if a 2D problem.
- If `block rectilinear`, then the `x`, `y`, `z` coordinates change to the `x`, `y`, and `z` delta vectors.
- If `block uniform`, then the `x`, `y`, `z` coordinates change to the `x`, `y`, `z` coordinates of the origin and the `x`, `y`, and `z` delta values.
- If `block range`, the `ijk` min/max range line must follow the `ijk` line. And the number of nodes and elements is based on the ranges. The `ijk` line indicates the size of the original block.
- If `with_ghost` is on the `block` line, then the `ghost_flag` section must be there
- Ids are just labels, the coordinate (or element) order is implied.
- The minimum needed for unstructured empty parts is the three lines:

```
part
      #                (use the actual part number)
description
```

- The minimum needed for structured empty parts is the five lines:

```
part
      #                (use the actual part number)
description
block
      0      0      0
```

- Element blocks for `nsided` elements contain an additional section - **the number of nodes in each element**. See below.

**C Binary form of element block, if nsided:**

```
nsided                                80 chars
ne                                     1 int
[id_n1 id_n2 ... id_ne]                ne ints
np1 np2 ... npne                       This data is needed ne ints
e1_n1 e1_n2 ... e1_np1
e2_n1 e2_n2 ... e2_np2
.
.
ne_n1 ne_n2 ... ne_npne                np1+np2+...+npne ints
```

**Fortran Binary form of element block, if nsided:**

```
'nsided'                               80 chars
'ne'                                    1 int
['id_n1 id_n2 ... id_ne']              ne ints
'np1 np2 ... npne'                     This data is needed ne ints
'e1_n1 e1_n2 ... e1_np1'
```

```

e2_n1 e2_n2 ... e2_np2
.
.
ne_n1 ne_n2 ... ne_npne'          np1+np2+...+npne ints

```

**Ascii form of element block, if nsided:**

```

nsided                               A
ne                                   I10
[id_n1                                I10   1/line (ne)
 id_n2
.
 id_ne]
np1                                This data is needed   I10   1/line (ne)
np2                                .
.
npne                                .
e1_n1 e1_n2 ... e1_np1              I10   np*/line
e2_n1 e2_n2 ... e2_np2              (ne lines)
.
ne_n1 ne_n2 ... ne_npne

```

- Element blocks for `nfaced` elements are more involved since they are described by their `nsided` faces. Thus, there is the optional section for `ids` (`id_e*`), a section for the number of faces per element (`nf_e*`), a section for number of nodes per face per element (`np(f*_e*)`), and a section for the connectivity of each `nsided` face of each element (`n*(f*_e*)`). See below.

**C Binary form of element block, if nfaced:**

```

nfaced                               80 chars
ne                                   1 int
[id_e1 id_e2 ... id_ne]              ne ints
nf_e1 nf_e2 ... nf_ne                 ne ints
np(f1_e1) np(f2_e1) ... np(nf_e1)
np(f1_e2) np(f2_e2) ... np(nf_e2)
.
.
np(f1_ne) np(f2_ne) ... np(nf_ne)    nf_e1+nf_e2+...+nf_ne ints
n1(f1_e1) n2(f1_e1) ... n(np(f1_e1))
n1(f2_e1) n2(f2_e1) ... n(np(f2_e1))
.
n1(nf_e1) n2(nf_e1) ... n(np(nf_e1))
n1(f1_e2) n2(f1_e2) ... n(np(f1_e2))
n1(f2_e2) n2(f2_e2) ... n(np(f2_e2))
.
n1(nf_e2) n2(nf_e2) ... n(np(nf_e2))
.
.
n1(f1_ne) n2(f1_ne) ... n(np(f1_ne))
n1(f2_ne) n2(f2_ne) ... n(np(f2_ne))
.
n1(nf_ne) n2(nf_ne) ... n(np(nf_ne))    np(f1_e1)+np(f2_e1)+...+np(nf_ne) ints

```

**Fortran Binary form of element block, if nfaced:**

```

'nfaced'                             80 chars
'ne'                                   1 int
['id_e1 id_e2 ... id_ne']            ne ints
'nf_e1 nf_e2 ... nf_ne'              ne ints

```

## 11.1 EnSight Gold Geometry File Format

```

`np(f1_e1) np(f2_e1) ... np(nf_e1)
np(f1_e2) np(f2_e2) ... np(nf_e2)
.
.
np(f1_ne) np(f2_ne) ... np(nf_ne)'           nf_e1+nf_e2+...+nf_ne ints
`n1(f1_e1) n2(f1_e1) ... n(np(f1_e1))
n1(f2_e1) n2(f2_e1) ... n(np(f2_e1))
.
n1(nf_e1) n2(nf_e1) ... n(np(nf_e1))
n1(f1_e2) n2(f1_e2) ... n(np(f1_e2))
n1(f2_e2) n2(f2_e2) ... n(np(f2_e2))
.
n1(nf_e2) n2(nf_e2) ... n(np(nf_e2))
.
.
n1(f1_ne) n2(f1_ne) ... n(np(f1_ne))
n1(f2_ne) n2(f2_ne) ... n(np(f2_ne))
.
n1(nf_ne) n2(nf_ne) ... n(np(nf_ne))'       np(f1_e1)+np(f2_e1)+...+np(nf_ne) ints

```

### Ascii form of element block, if nfacd:

```

nfacd                                     A
ne                                       I10
[id_e1                                   I10  1/line
 id_e2                                   (ne lines)
.
 id_ne]
nf_e1                                    I10  1/line
nf_e2                                    (ne lines)
.
nf_ne
np(f1_e1)                                I10  1/line
np(f2_e1)                                (nf_e1+nf_e2+...+nf_ne lines)
.
np(nf_e1)
np(f1_e2)
np(f2_e2)
.
np(nf_e2)
.
.
np(f1_ne)
np(f2_ne)
.
np(nf_ne)
n1(f1_e1) n2(f1_e1) ... n(np(f1_e1))      I10 np*/line
n1(f2_e1) n2(f2_e1) ... n(np(f2_e1))      (nf_e1+nf_e2+...+nf_ne lines)
.
n1(nf_e1) n2(nf_e1) ... n(np(nf_e1))
n1(f1_e2) n2(f1_e2) ... n(np(f1_e2))
n1(f2_e2) n2(f2_e2) ... n(np(f2_e2))
.
n1(nf_e2) n2(nf_e2) ... n(np(nf_e2))
.
.
n1(f1_ne) n2(f1_ne) ... n(np(f1_ne))
n1(f2_ne) n2(f2_ne) ... n(np(f2_ne))
.
n1(nf_ne) n2(nf_ne) ... n(np(nf_ne))

```



### Structured Part

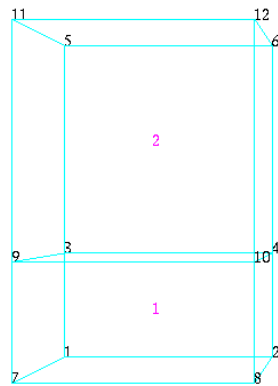

part 3

### Unstructured Parts

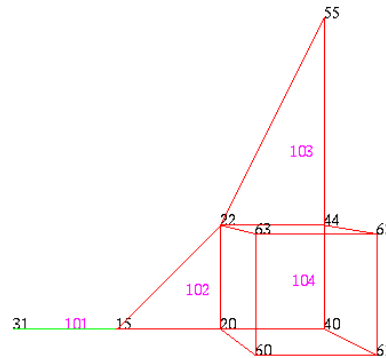

part 1

part 2

#### EnSight Gold

#### Geometry File Example

The following is an example of an ASCII EnSight Gold geometry file: This is the same example model as given in the EnSight6 geometry file section (only in Gold format) with 11 defined unstructured nodes from which 2 unstructured parts are defined, and a 2x3x2 structured part as depicted in the above diagram.

*Note:* The example file below (`engold.geo`) and all example variable files in the gold section (also prefixed with `engold`) may be found under your EnSight installation directory (path: `$CEI_HOME/ensight80/data/user_manual`).

*Note:* The appended “#” comment lines are for your reference only, and are not valid format lines within a geometry file as appended below. **Do NOT put these # comments in your file!!!**

```

This is the 1st description line of the EnSight Gold geometry example
This is the 2nd description line of the EnSight Gold geometry example
node id given
element id given
extents
  0.00000e+00 2.00000e+00
  0.00000e+00 2.00000e+00
  0.00000e+00 2.00000e+00
part
  1
2D uns-elements (description line for part 1)
coordinates
  10          # nn          Do NOT put these # comments in your file!!!
  15          # node ids
  20
  40
  22
  44
  55
  60
  61
  62
  63
  4.00000e+00 # x components
  5.00000e+00
  6.00000e+00

```

## 11.1 EnSight Gold Geometry File Format

```

5.00000e+00
6.00000e+00
6.00000e+00
5.00000e+00
6.00000e+00
6.00000e+00
5.00000e+00
0.00000e+00      # y components
0.00000e+00
0.00000e+00
1.00000e+00
1.00000e+00
3.00000e+00
0.00000e+00
0.00000e+00
1.00000e+00
1.00000e+00
0.00000e+00      # z components
0.00000e+00
0.00000e+00
0.00000e+00
0.00000e+00
0.00000e+00
2.00000e+00
2.00000e+00
2.00000e+00
2.00000e+00
tria3      # element type
      2      # ne
      102     # element ids
      103
      1      2      4
      4      5      6
hexa8
      1
      104
      2      3      5      4      7      8      9      10
part
      2
1D uns-elements (description line for part 2)
coordinates
      2
      15
      31
4.00000e+00
3.00000e+00
0.00000e+00
0.00000e+00
0.00000e+00
0.00000e+00
bar2
      1
      101
      2      1
part
      3
3D struct-part (description line fro part 3)
block iblanked
      2      3      2
0.00000e+00      # i components
2.00000e+00
0.00000e+00
2.00000e+00
0.00000e+00
2.00000e+00
0.00000e+00
2.00000e+00

```

```
0.00000e+00
2.00000e+00
0.00000e+00
2.00000e+00
0.00000e+00      # j components
0.00000e+00
1.00000e+00
1.00000e+00
3.00000e+00
3.00000e+00
0.00000e+00
0.00000e+00
1.00000e+00
1.00000e+00
3.00000e+00
3.00000e+00
0.00000e+00      # k components
0.00000e+00
0.00000e+00
0.00000e+00
0.00000e+00
0.00000e+00
0.00000e+00
2.00000e+00
2.00000e+00
2.00000e+00
2.00000e+00
2.00000e+00
2.00000e+00
0.00000e+00      # iblanking
1
1
1
1
1
1
1
1
1
1
1
1
1
1
1
```

*Simple example  
using nsided/  
nfaced elements*

The following is an example of an ASCII EnSight Gold geometry file with nsided and nfaced data. It is a non-realistic, simple model which is intended only to illustrate the format. Two nsided elements and three nfaced elements are used, even though the model could have been represented with a single nsided and single nfaced element.

*Note: The appended “#” comment lines are for your reference only, and are not valid format lines within a geometry file as appended below. **Do NOT put these # comments in your file!!!***

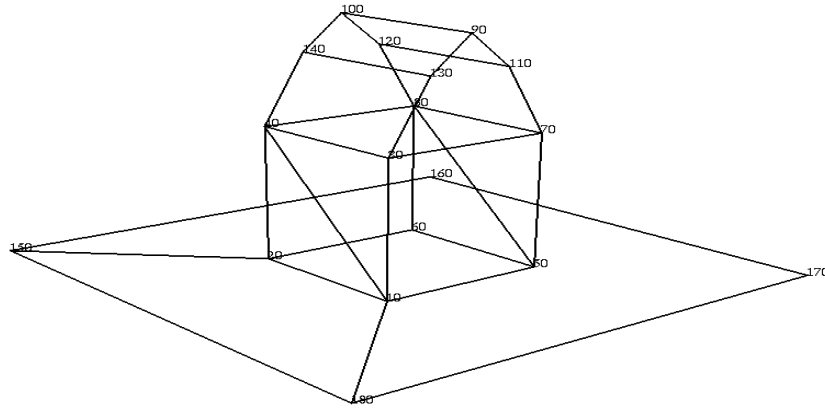

```
simple example for nsided/nfaced
element types in EnSight Gold Format
node id given
element id given
extents
-2.00000e+00 4.00000e+00
 0.00000e+00 3.50000e+00
-2.00000e+00 4.00000e+00
part
```

```
    1
barn
coordinates
```

```
    18          # nn
    10          # node ids
    20
    30
    40
    50
    60
    70
    80
    90
    100
    110
    120
    130
    140
    150
    160
    170
    180
    0.00000e+00 # x components
    2.00000e+00
    0.00000e+00
    2.00000e+00
```

*Do NOT put these # comments in your file!!*

```

0.00000e+00
2.00000e+00
0.00000e+00
2.00000e+00
0.00000e+00
2.00000e+00
0.00000e+00
2.00000e+00
0.00000e+00
2.00000e+00
4.00000e+00
4.00000e+00
-2.00000e+00
-2.00000e+00
0.00000e+00          # y components
0.00000e+00
2.00000e+00
2.00000e+00
0.00000e+00
0.00000e+00
2.00000e+00
2.00000e+00
3.50000e+00
3.50000e+00
3.00000e+00
3.00000e+00
3.00000e+00
3.00000e+00
0.00000e+00
0.00000e+00
0.00000e+00
0.00000e+00
0.00000e+00          # x components
0.00000e+00
0.00000e+00
0.00000e+00
0.00000e+00
2.00000e+00
2.00000e+00
2.00000e+00
2.00000e+00
1.00000e+00
1.00000e+00
1.50000e+00
1.50000e+00
0.50000e+00
0.50000e+00
-2.00000e+00
4.00000e+00
4.00000e+00
-2.00000e+00
nsided
  2          # 2 nsided elements
 101        # element ids
 202
  4          # 4 nodes in first element
  8          # 8 nodes in second element
  2         15      18      1          # connectivity of element 1
  1         18      17      16      15      2      6      5          # connectivity of element 2
nfacd
  3          # 3 nfacd polyhedra elements
 1001        # element ids
 1002
 1003
  5          # number of faces in element 1
  5          # number of faces in element 2
  7          # number of faces in element 3
  3          # number of nodes in face 1 of element 1

```

## 11.1 EnSight Gold Geometry File Format

```

3          #          face 2 of element 1
4          #          face 3 of element 1
4          #          face 4 of element 1
4          #          face 5 of element 1
3          # number of nodes in face 1 of element 2
3          #          face 2 of element 2
4          #          face 3 of element 2
4          #          face 4 of element 2
4          #          face 5 of element 2
5          # number of nodes in face 1 of element 3
5          #          face 2 of element 3
4          #          face 3 of element 3
4          #          face 4 of element 3
4          #          face 5 of element 3
4          #          face 6 of element 3
4          #          face 7 of element 3
5          6          8          # connectivity of face 1 of element 1
2          1          4          #          face 2 of element 1
6          2          4          8          #          face 3 of element 1
8          4          1          5          #          face 4 of element 1
1          2          6          5          #          face 5 of element 1
5          8          7          # connectivity of face 1 of element 2
1          3          4          #          face 2 of element 2
7          8          4          3          #          face 3 of element 2
7          3          1          5          #          face 4 of element 2
5          1          4          8          #          face 5 of element 2
8          4          14         10         12          # connectivity of face 1 of element 3
7          11         9          13         3           #          face 2 of element 3
7          8          12         11          #          face 3 of element 3
11         12         10         9          #          face 4 of element 3
9          10         14         13         #          face 5 of element 3
13         14         4          3          #          face 6 of element 3
7          3          4          8          #          face 7 of element 3

```

*Simple examples using ghost cells*

The following two ASCII EnSight Gold geometry file examples show use of ghost cells in unstructured and structured models. First the geometry file for the total model, composed of four parts, is given without any ghost cells. Then, two of four separate geometry files – each containing just one of the original parts (and appropriate ghost cells) will be given. This is supposed to simulate a decomposed model, such as you might provide for EnSight’s Server-of-Servers.

*Note:* For unstructured models, ghost cells are simply a new element type. For structured models, ghost cells are an “iblack”-like flag.

Unstructured model

Nodes

21	22	23	24	25
16	17	18	19	20
part 3		part 4		
11	12	13	14	15
6	7	8	9	10
part 1		part 2		
1	2	3	4	5

Elements

13	14	15	16
part 3		part 4	
9	10	11	12
5	6	7	8
part 1		part 2	
1	2	3	4

Total Unstructured Model Geometry File:

EnSight Model Geometry File	1.00000e+00			
EnSight 7.1.0	1.00000e+00			
node id given	1.00000e+00			
element id given	2.00000e+00			
extents	2.00000e+00			
0.00000e+00 4.00000e+00	2.00000e+00			
0.00000e+00 4.00000e+00	0.00000e+00			
0.00000e+00 0.00000e+00	0.00000e+00			
part	0.00000e+00			
1	0.00000e+00			
bottom left	0.00000e+00			
coordinates	0.00000e+00			
9	0.00000e+00			
1	0.00000e+00			
2	0.00000e+00			
3	0.00000e+00			
6	quad4			
7	4			
8	1			
11	2			
12	5			
13	6			
0.00000e+00	1	2	5	4
1.00000e+00	2	3	6	5
2.00000e+00	4	5	8	7
0.00000e+00	5	6	9	8
1.00000e+00	part			
2.00000e+00	2			
0.00000e+00	bottom right			
1.00000e+00	coordinates			
2.00000e+00	9			
0.00000e+00	3			
0.00000e+00	4			
0.00000e+00	5			
0.00000e+00	8			

11.1 EnSight Gold Geometry File Format

9					4.00000e+00
10					4.00000e+00
13					0.00000e+00
14					0.00000e+00
15					0.00000e+00
2.00000e+00					0.00000e+00
3.00000e+00					0.00000e+00
4.00000e+00					0.00000e+00
2.00000e+00					0.00000e+00
3.00000e+00					0.00000e+00
4.00000e+00					0.00000e+00
2.00000e+00					0.00000e+00
3.00000e+00					0.00000e+00
4.00000e+00					0.00000e+00
0.00000e+00					0.00000e+00
0.00000e+00					0.00000e+00
0.00000e+00					0.00000e+00
1.00000e+00					0.00000e+00
1.00000e+00					0.00000e+00
1.00000e+00					0.00000e+00
2.00000e+00					0.00000e+00
2.00000e+00					0.00000e+00
2.00000e+00					0.00000e+00
0.00000e+00					0.00000e+00
0.00000e+00					0.00000e+00
0.00000e+00					0.00000e+00
0.00000e+00					0.00000e+00
0.00000e+00					0.00000e+00
0.00000e+00					0.00000e+00
0.00000e+00					0.00000e+00
0.00000e+00					0.00000e+00
0.00000e+00					0.00000e+00
quad4					quad4
4					4
3					9
4					10
7					13
8					14
1					1
2					2
4					4
5					5
part					part
3					4
top left					top right
coordinates					coordinates
9					9
11					13
12					14
13					15
16					18
17					19
18					20
21					23
22					24
23					25
0.00000e+00					2.00000e+00
1.00000e+00					3.00000e+00
2.00000e+00					4.00000e+00
0.00000e+00					2.00000e+00
1.00000e+00					3.00000e+00
2.00000e+00					4.00000e+00
0.00000e+00					2.00000e+00
1.00000e+00					3.00000e+00
2.00000e+00					4.00000e+00
0.00000e+00					2.00000e+00
1.00000e+00					3.00000e+00
2.00000e+00					4.00000e+00
2.00000e+00					2.00000e+00
2.00000e+00					3.00000e+00
2.00000e+00					4.00000e+00
2.00000e+00					2.00000e+00
3.00000e+00					3.00000e+00
3.00000e+00					4.00000e+00
3.00000e+00					2.00000e+00
4.00000e+00					3.00000e+00
4.00000e+00					4.00000e+00
quad4					quad4
4					4
11					11
12					12
15					15
16					16
1					1
2					2
4					4
5					5
part					part
2					2
3					3
4					4
5					5
part					part
5					5
6					6
9					9
8					8



Portion with part 1 containing ghost cells (other parts are empty)

Nodes

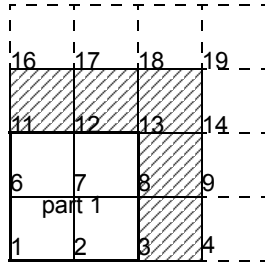

Elements

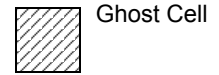
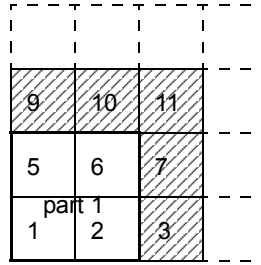

EnSight Model Geometry File	2.00000e+00			
part 1 portion	2.00000e+00			
node id given	2.00000e+00			
element id given	3.00000e+00			
extents	3.00000e+00			
0.00000e+00 4.00000e+00 0.00000e+00	3.00000e+00			
4.00000e+00	3.00000e+00			
0.00000e+00 0.00000e+00	0.00000e+00			
part	0.00000e+00			
1	0.00000e+00			
bottom left	0.00000e+00			
coordinates	0.00000e+00			
16	0.00000e+00			
1	0.00000e+00			
2	0.00000e+00			
3	0.00000e+00			
4	0.00000e+00			
6	0.00000e+00			
7	0.00000e+00			
8	0.00000e+00			
9	0.00000e+00			
11	0.00000e+00			
12	0.00000e+00			
13	0.00000e+00			
14	quad4			
16	4			
17	1			
18	2			
19	5			
0.00000e+00	6			
1.00000e+00	1	2	6	5
2.00000e+00	2	3	7	6
3.00000e+00	5	6	10	9
0.00000e+00	6	7	11	10
1.00000e+00	g_quad4			
2.00000e+00	5			
3.00000e+00	1			
0.00000e+00	1			
1.00000e+00	1			
2.00000e+00	1			
3.00000e+00	3	4	8	7
0.00000e+00	7	8	12	11
1.00000e+00	9	10	14	13
2.00000e+00	10	11	15	14
3.00000e+00	11	12	16	15
0.00000e+00	part			/* Empty part */
0.00000e+00	2			
0.00000e+00	bottom right			
0.00000e+00	part			/* Empty part */
1.00000e+00	3			
1.00000e+00	top left			
1.00000e+00	part			/* Empty part */
1.00000e+00	4			
2.00000e+00	top right			



Structured model

(using essentially the same model, but in structured format):

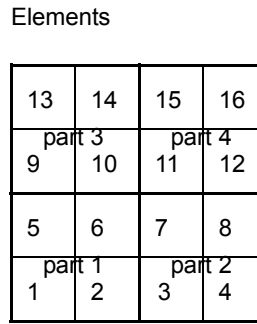
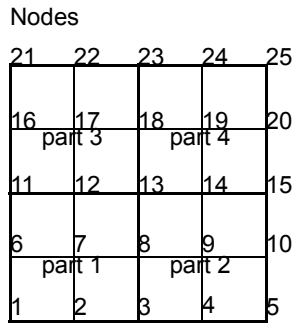

5 x 5 x 1 Total Structured Model

```

EnSight Model Geometry File
Total Structured Model
node id assign
element id assign
extents
  0.00000e+00 4.00000e+00
  0.00000e+00 4.00000e+00
  0.00000e+00 0.00000e+00
part
  1
left bottom
block uniform range
  5 5 1
  1 3 1 3 1 1
  0.00000e+00
  0.00000e+00
  0.00000e+00
  1.00000e+00
  1.00000e+00
  0.00000e+00
part
  2
bottom right
block uniform range
  5 5 1
  3 5 1 3 1 1
  2.00000e+00
  0.00000e+00
  0.00000e+00
  1.00000e+00
  1.00000e+00
  0.00000e+00
part
  3
top left
block uniform range
  5 5 1
  1 3 3 5 1 1
  0.00000e+00
  2.00000e+00
  0.00000e+00
  1.00000e+00
  1.00000e+00
  0.00000e+00
part
  4
top right
block uniform range
  5 5 1
  3 5 3 5 1 1
  2.00000e+00
  2.00000e+00
  0.00000e+00
  1.00000e+00
  1.00000e+00
  0.00000e+00

```

Portion with part 1 containing ghost cells (other parts are empty)

Nodes

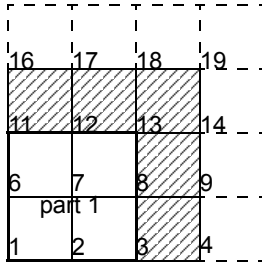

Elements

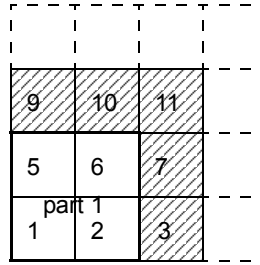

```

EnSight Model Geometry File
part 1 portion only
node id assign
element id assign
extents
  0.00000e+00 4.00000e+00
  0.00000e+00 4.00000e+00
  0.00000e+00 0.00000e+00
part
  1
left bottom
block uniform range with_ghost
  4 4 1
  1 4 1 4 1 1
  0.00000e+00
  0.00000e+00
  0.00000e+00
  1.00000e+00
  1.00000e+00
  0.00000e+00
ghost_flags
  0
  0
  1
  0
  0
  1
  1
  1
  1
  1
Part 2 /* Empty Part */
right bottom
block
  0 0 0
part 3 /* Empty Part */
left top
block
  0 0 0
part 4 /* Empty Part */
right top
block
  0 0 0
  
```

## Portion with part 2 containing ghost cells (other parts are empty)

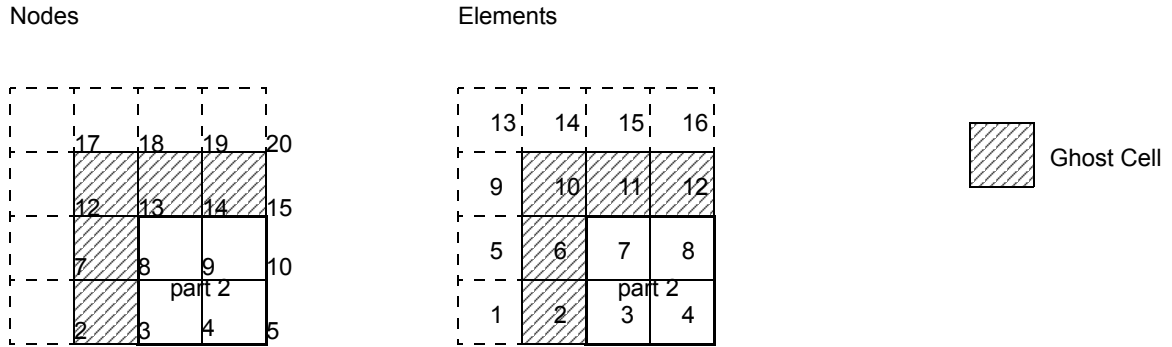

```

EnSight Model Geometry File
part 2 portion only
node id assign
element id assign
extents
  0.00000e+00 4.00000e+00
  0.00000e+00 4.00000e+00
  0.00000e+00 0.00000e+00
part
  1
left bottom
block
  0      0      0
part
  2
right bottom
block uniform range with_ghost
  4      4      1      4      1      1
  2      5      1
  1.00000e+00
  0.00000e+00
  0.00000e+00
  1.00000e+00
  1.00000e+00
  0.00000e+00
ghost_flags
  1
  0
  0
  1
  0
  0
  1
  1
  1
  1
part
  3      /* Empty Part */
left top
block
  0      0      0
part
  4      /* Empty Part */
right top
block
  0      0      0

```

*Note: For both the unstructured and the structured model above, only the first two files (parts 1 and 2) are given. The portion files for parts 3 and 4 are not given, but would be similar to those for parts 1 and 2.*

## EnSight Gold Case File Format

The Case file is an ASCII free format file that contains all the file and name information for accessing model (and measured) geometry, variable, and time information. It is comprised of five sections (FORMAT, GEOMETRY, VARIABLE, TIME, FILE) as described below:

*Notes:* All lines in the Case file are limited to 79 characters.  
 The titles of each section must be in all capital letters.  
 Anything preceded by a “#” denotes a comment and is ignored. Comments may append information lines or be placed on their own lines.  
 Information following “:” may be separated by white spaces or tabs.  
 Specifications encased in “[ ]” are optional, as indicated.

### Format Section

This is a required section which specifies the type of data to be read.

Usage:

```
FORMAT
type:    ensight gold
```

### Geometry Section

This is a required section which specifies the geometry information for the model (as well as measured geometry if present, and periodic match file ([see Section 11.9, Periodic Matchfile Format](#)) if present).

Usage:

```
GEOMETRY
model:    [ts] [fs]      filename    [change_coords_only]
measured: [ts] [fs]      filename    [change_coords_only]
match:    filename
boundary: filename
```

where: *ts* = time set number as specified in TIME section. This is optional.

*fs* = corresponding file set number as specified in FILE section below.

**(Note, if you specify *fs*, then *ts* is no longer optional and must also be specified.)**

*filename* = The filename of the appropriate file.

-> Model or measured filenames for a static geometry case, as well as match and boundary filenames will not contain “\*” wildcards.

-> Model or measured filenames for a changing geometry case will contain “\*” wildcards.

*change\_coords\_only* = The option to indicate that the changing geometry (as indicated by wildcards in the filename) is coords only. Otherwise, changing geometry connectivity will be assumed.

### Variable Section

This is an optional section which specifies the files and names of the variables. Constant variable values can also be set in this section.

Usage:

```
VARIABLE
constant per case:          [ts]          description const_value(s)
constant per case file:    [ts]          description cvfilename
scalar per node:           [ts] [fs]      description filename
vector per node:           [ts] [fs]      description filename
tensor symm per node:      [ts] [fs]      description filename
tensor asym per node:      [ts] [fs]      description filename
scalar per element:        [ts] [fs]      description filename
```

```

vector per element:          [ts] [fs]  description filename
tensor symm per element:    [ts] [fs]  description filename
tensor asym per element:    [ts] [fs]  description filename
scalar per measured node:   [ts] [fs]  description filename
vector per measured node:   [ts] [fs]  description filename
complex scalar per node:    [ts] [fs]  description Re_fn  Im_fn  freq
complex vector per node:    [ts] [fs]  description Re_fn  Im_fn  freq

complex scalar per element:  [ts] [fs]  description Re_fn  Im_fn  freq
complex vector per element:  [ts] [fs]  description Re_fn  Im_fn  freq

```

where:

```

ts          = The corresponding time set number (or index) as specified in TIME
              section below. This is only required for transient constants and
              variables.
fs          = The corresponding file set number (or index) as specified in FILE
              section below.
              (Note, if you specify fs, then ts is no longer optional and must
              also be specified.)
description = The variable (GUI) name (ex. Pressure, Velocity, etc.)
const_value(s) = The constant value. If constants change over time, then ns (see
                  TIME section below) constant values of ts.
cvfilename   = The filename containing the constant values, one value per time step.
filename     = The filename of the variable file. Note: only transient filenames
              contain "*" wildcards.
Re_fn        = The filename for the file containing the real values of the complex
              variable.
Im_fn        = The filename for the file containing the imaginary values of the
              complex variable.
freq         = The corresponding harmonic frequency of the complex variable.
              For complex variables where harmonic frequency is undefined,
              simply use the text string: UNDEFINED.

```

*Note: As many variable description lines as needed may be used.*

*Note: Variable descriptions have the following restrictions:*

*The variable description is limited to 19 characters in the current release.*

*Duplicate variable descriptions are not allowed.*

*Leading and trailing white space will be eliminated.*

*Variable descriptions must not start with a numeric digit.*

*Variable descriptions must not contain any of the following reserved characters:*

```

(  [  +  @  !  *  $
)  ]  -  space  #  ^  /

```

### Time Section

This is an optional section for steady state cases, but is required for transient cases. It contains time set information. Shown below is information for one time set. Multiple time sets (up to 16) may be specified for measured data as shown in Case File Example 3 below.

Usage:

```

TIME
time set:          ts [description]
number of steps:   ns
filename start number: fs
filename increment: fi
time values:       time_1 time_2 .... time_ns

```

or

```

TIME
time set:          ts [description]
number of steps:   ns
filename numbers:  fn
time values:       time_1 time_2 .... time_ns

```

or

```

TIME
time set:          ts [description]
number of steps:   ns
filename numbers file: fnfilename
time values file:  tvfilename

```

where: *ts* = timeset number. This is the number referenced in the GEOMETRY and VARIABLE sections.

*description* = optional timeset description which will be shown in user interface.

*ns* = number of transient steps

*fs* = the number to replace the "\*" wildcards in the filenames, for the first step

*fi* = the increment to *fs* for subsequent steps

*time* = the actual time values for each step, each of which must be separated by a white space and which may continue on the next line if needed

*fn* = a list of numbers or indices, to replace the "\*" wildcards in the filenames.

*fnfilename* = name of file containing *ns* filename numbers (*fn*).

*tvfilename* = name of file containing the time values(*time\_1* ... *time\_ns*).

### File Section

This section is optional for expressing a transient case with single-file formats. This section contains single-file set information. This information specifies the number of time steps in each file of each *data entity*, i.e. each geometry and each variable (model and/or measured). Each data entity's corresponding file set might have multiple *continuation* files due to system file size limit, i.e. ~2 GB for 32-bit and ~4 TB for 64-bit architectures. **Each file set corresponds to one and only one time set, but a time set may be referenced by many file sets.** The following information may be specified in each file set. For file sets where all of the time set data exceeds the maximum file size limit of the system, both *filename index* and *number of steps* are repeated within the file set definition for each continuation file required. Otherwise *filename index* may be omitted if there is only one file. File set information is shown in Case File Example 4 below.

Usage:

```

FILE
file set:          fs
filename index:    fi # Note: only used when data continues in other files
number of steps:  ns

```

where: *fs* = file set number. This is the number referenced in the GEOMETRY and VARIABLE sections above.

*ns* = number of transient steps

*fi* = file index number in the file name (replaces "\*" in the filenames)



**Material Section** This is an optional section for material interface part case. It contains material set information. Shown below is information for one material set. (**Note, currently only one material set is supported.**) An example of this material set information is appended to [EnSight Gold Material Files Format](#).

**Usage:**

```
MATERIAL
material set number:      ms [description]
material id count:       nm
material id numbers:     matno_1 matno_2 ... matno_nm
material id names:       matdesc_1 mat_2 ... mat_nm
material id per element: [ts] [fs] filename
material mixed ids:      [ts] [fs] filename
material mixed values:   [ts] [fs] filename

where:
ts = The corresponding time set number (or index) as specified in TIME section
    above. This is only required for transient materials.

fs = The corresponding file set number (or index) as specified in FILE section
    above. (Note, if you specify fs, then ts is no longer optional and must also be
    specified.)

ms = Material set number. (Note, currently there is only one, and it must be a
    positive number.)

description = Optional material set description which will be reflected in the file
    names of exported material files.

nm = Number of materials for this set.

matno = Material number used in the material and mixed-material id files. There
    should be nm of these. Non-positive numbers are grouped as the "null
    material". See EnSight Gold Material Files Format

matdesc = GUI material description corresponding to the nm matno's.

filename = The filename of the appropriate material file. Note, only transient
    filenames contain "*" wildcards. The three required files are the
    material id per element, the mixed-material ids, and the mixed-material
    values files.
```

**Note:** *Material descriptions are limited to 19 characters in the current release. Material descriptions and file names must not start with a numeric digit and must not contain any of the following reserved characters:*

```
( [ + @ ! * $
) ] - # ^ / space
```

**Case File Example 1** The following is a minimal EnSight Gold case file for a steady state model with some results.

*Note: this (engold.case) file, as well as all of its referenced geometry and variable files (along with a couple of command files) can be found under your installation directory (path: \$CEI\_HOME/ensight80/data/user\_manual). The EnSight Gold Geometry File Example and the Variable File Examples are the contents of these files.*

```
FORMAT
type: ensight gold

GEOMETRY
model: engold.geo

VARIABLE
constant per case:      Cden .8
```

## 11.1 EnSight Gold Case File Format

```

scalar per element:      Esca  engold.Esca
scalar per node:        Nsca  engold.Nsca

vector per element:     Evec  engold.Evec
vector per node:        Nvec  engold.Nvec

tensor symm per element: Eten  engold.Eten
tensor symm per node:   Nten  engold.Nten

complex scalar per element: Ecmp  engold.Ecmp_rengold.Ecmp_i2.
complex scalar per node:  Ncmp  engold.Ncmp_rengold.Ncmp_i4.

```

**Case File Example 2** The following is a Case file for a transient model. The connectivity of the geometry is also changing.

```

FORMAT
type:  ensight gold

GEOMETRY
model:          1                exgold2.geo**

VARIABLE
scalar per node:  1      Stress      exgold2.scl**
vector per node:  1      Displacement exgold2.dis**

TIME
time set:          1
number of steps:   3
filename start number: 0
filename increment: 1
time values:       1.0  2.0  3.0

```

The following files would be needed for Example 2:

```

exgold2.geo00      exgold2.scl00      exgold2.dis00
exgold2.geo01      exgold2.scl01      exgold2.dis01
exgold2.geo02      exgold2.scl02      exgold2.dis02

```

**Case File Example 3** The following is a Case file for a transient model with measured data.

*This example has pressure given per element.*

```

FORMAT
type:  ensight gold

GEOMETRY
model:          1                exgold3.geo*
measured:       2                exgold3.mgeo**

VARIABLE
constant per case:          Gamma      1.4
constant per case:          Density    .9 .9 .7 .6 .6
scalar per element:         1          Pressure    exgold3.pre*
vector per node:            1          Velocity    exgold3.vel*
scalar per measured node:   2          Temperature exgold3.mtem**
vector per measured node:   2          Velocity    exgold3.mvel**

TIME
time set:          1
number of steps:   5
filename start number: 1
filename increment: 2
time values:       .1 .2 .3          # This example shows that time

```

```

                                .4 .5           # values can be on multiple lines
time set:                        2
number of steps:                 6
filename start number:          0
filename increment:             2
time values:
.05 .15 .25 .34 .45 .55

```

The following files would be needed for Example 3:

exgold3.geo1	exgold3.pre1	exgold3.vel1
exgold3.geo3	exgold3.pre3	exgold3.vel3
exgold3.geo5	exgold3.pre5	exgold3.vel5
exgold3.geo7	exgold3.pre7	exgold3.vel7
exgold3.geo9	exgold3.pre9	exgold3.vel9
exgold3.mgeo00	exgold3.mtem00	exgold3.mvel100
exgold3.mgeo02	exgold3.mtem02	exgold3.mvel102
exgold3.mgeo04	exgold3.mtem04	exgold3.mvel104
exgold3.mgeo06	exgold3.mtem06	exgold3.mvel106
exgold3.mgeo08	exgold3.mtem08	exgold3.mvel108
exgold3.mgeo10	exgold3.mtem10	exgold3.mvel110

Case File Example 4 The following is Case File Example 3 expressed in transient single-file formats.

*In this example, the transient data for the measured velocity data entity happens to be greater than the maximum file size limit. Therefore, the first four time steps fit and are contained in the first file, and the last two time steps are 'continued' in a second file.*

```

FORMAT
type: ensight gold

GEOMETRY
model:          1   1   exgold4.geo
measured:      2   2   exgold4.mgeo

VARIABLE
constant per case:           Density           .5
scalar per element:         1   1   Pressure     exgold4.pre
vector per node:            1   1   Velocity     exgold4.vel
scalar per measured node:   2   2   Temperature  exgold4.mtem
vector per measured node:   2   3   Velocity     exgold4.mvel*

TIME
time set:          1   Model
number of steps:   5
time values:       .1 .2 .3 .4 .5

time set:          2   Measured
number of steps:   6
time values:       .05 .15 .25 .34 .45 .55

FILE
file set:          1
number of steps:   5

file set:          2

```

```

number of steps:      6

file set:            3
filename index:      1
number of steps:      4
filename index:      2
number of steps:      2
    
```

The following files would be needed for Example 4:

```

exgold4.geo      exgold4.pre      exgold4.vel
exgold4.mgeo     exgold4.mtem     exgold4.mvel1
exgold4.mvel2
    
```

Contents of  
Transient  
Single Files

Each file contains transient data that corresponds to the specified number of time steps. The data for each time step sequentially corresponds to the simulation time values (time values) found listed in the TIME section. In transient single-file format, the data for each time step essentially corresponds to a standard EnSight gold geometry or variable file (model or measured) as expressed in multiple file format. The data for each time step is enclosed between two *wrapper* records, i.e. preceded by a BEGIN TIME STEP record and followed by an END TIME STEP record. Time step data is not split between files. If there is not enough room to append the data from a time step to the file without exceeding the maximum file limit of a particular system, then a continuation file must be created for the time step data and any subsequent time step. Any type of user comments may be included before and/or after each transient step wrapper.

*Note 1: If transient single file format is used, EnSight expects all files of a dataset to be specified in transient single file format. Thus, even static files must be enclosed between a BEGIN TIME STEP and an END TIME STEP wrapper. This includes the condition where you have transient variables with static geometry. The static geometry file must have the wrapper.*

1. *Note 2: For binary geometry files, the first BEGIN TIME STEP wrapper must follow the <C Binary/Fortran Binary> line. Both BEGIN TIME STEP and END TIME STEP wrappers are written according to type (1) in binary. Namely: This is a write of 80 characters to the file:*

```

in C: char buffer[80];
      strcpy(buffer, "BEGIN TIME STEP");
      fwrite(buffer, sizeof(char), 80, file_ptr);
    
```

```

in FORTRAN: character*80 buffer
            buffer = "BEGIN TIME STEP"
    
```

*Note 3: Efficient reading of each file (especially binary) is facilitated by appending each file with a **file index**. A file index contains appropriate information to access the file byte positions of each time step in the file. (EnSight automatically appends a file index to each file when exporting in transient single file format.) If used, the file index must follow the last END TIME STEP wrapper in each file.*

**File Index Usage:**

ASCII	Binary	Item	Description
"%20d\n"	sizeof(int)	n	Total number of data time steps in the file.
"%20d\n"	sizeof(long)	fb <sub>1</sub>	File byte loc for contents of 1 <sup>st</sup> time step*
"%20d\n"	sizeof(long)	fb <sub>2</sub>	File byte loc for contents of 2 <sup>nd</sup> time step*

ASCII	Binary	Item	Description
...	...	...	...
"%20d\n"	sizeof(long)	fb <sub>n</sub>	File byte loc for contents of n <sup>th</sup> time step *
"%20d\n"	sizeof(int)	flag	Miscellaneous flag (= 0 for now)
"%20d\n"	sizeof(long)	fb of item n	File byte loc for Item n above
"%s\n"	sizeof(char)*80	"FILE_INDEX"	File index keyword

\* Each file byte location is the first byte that follows the BEGIN TIME STEP record.

Shown below are the contents of each of the above files, using the data files from Case File Example 3 for reference (without FILE\_INDEX for simplicity).

Contents of file exgold4.geo\_1:

```
BEGIN TIME STEP
Contents of file exgold3.geo1
END TIME STEP
BEGIN TIME STEP
Contents of file exgold3.geo3
END TIME STEP
BEGIN TIME STEP
Contents of file exgold3.geo5
END TIME STEP
BEGIN TIME STEP
Contents of file exgold3.geo7
END TIME STEP
BEGIN TIME STEP
Contents of file exgold3.geo9
END TIME STEP
```

Contents of file exgold4.pre\_1:

```
BEGIN TIME STEP
Contents of file exgold3.pre1
END TIME STEP
BEGIN TIME STEP
Contents of file exgold3.pre3
END TIME STEP
BEGIN TIME STEP
Contents of file exgold3.pre5
END TIME STEP
BEGIN TIME STEP
Contents of file exgold3.pre7
END TIME STEP
BEGIN TIME STEP
Contents of file exgold3.pre9
END TIME STEP
```

Contents of file exgold4.vel\_1:

```
BEGIN TIME STEP
Contents of file exgold3.vel1
END TIME STEP
BEGIN TIME STEP
Contents of file exgold3.vel3
END TIME STEP
BEGIN TIME STEP
Contents of file exgold3.vel5
END TIME STEP
BEGIN TIME STEP
Contents of file exgold3.vel7
END TIME STEP
BEGIN TIME STEP
Contents of file exgold3.vel9
END TIME STEP
```

Contents of file exgold4.mgeo\_1:

```
BEGIN TIME STEP
Contents of file exgold3.mgeo00
END TIME STEP
BEGIN TIME STEP
Contents of file exgold3.mgeo02
END TIME STEP
BEGIN TIME STEP
Contents of file exgold3.mgeo04
END TIME STEP
BEGIN TIME STEP
Contents of file exgold3.mgeo06
END TIME STEP
BEGIN TIME STEP
Contents of file exgold3.mgeo08
```

```

END TIME STEP
BEGIN TIME STEP
Contents of file exgold3.mgeo10
END TIME STEP

Contents of file exgold4.mtem_1:
BEGIN TIME STEP
Contents of file exgold3.mtem00
END TIME STEP
BEGIN TIME STEP
Contents of file exgold3.mtem02
END TIME STEP
BEGIN TIME STEP
Contents of file exgold3.mtem04
END TIME STEP
BEGIN TIME STEP
Contents of file exgold3.mtem06
END TIME STEP
BEGIN TIME STEP
Contents of file exgold3.mtem08
END TIME STEP
BEGIN TIME STEP
Contents of file exgold3.mtem10
END TIME STEP

Contents of file exgold4.mvel1_1:
BEGIN TIME STEP
Contents of file exgold3.mvel100
END TIME STEP
BEGIN TIME STEP
Contents of file exgold3.mvel102
END TIME STEP
BEGIN TIME STEP
Contents of file exgold3.mvel104
END TIME STEP
BEGIN TIME STEP
Contents of file exgold3.mvel106
END TIME STEP

Contents of file exgold4.mvel2_1:
Comments can precede the beginning wrapper here.
BEGIN TIME STEP
Contents of file exgold3.mvel108
END TIME STEP
Comments can go between time step wrappers here.
BEGIN TIME STEP
Contents of file exgold3.mvel110
END TIME STEP
Comments can follow the ending time step wrapper.

```

*Note: Each of these files could (and should for efficiency reasons) have the FILE\_INDEX information following the last END TIMESTEP. See the previous discussion for its usage.*

### ***EnSight Gold Wild Card Name Specification***

If multiple time steps are involved, the file names must conform to the EnSight wild-card specification. This specification is as follows:

- File names must include numbers that are in ascending order from beginning to end.
- Numbers in the files names must be zero filled if there is more than one significant digit.
- Numbers can be anywhere in the file name.
- When the file name is specified in the EnSight case file, you must replace the numbers in the file with an asterisk(\*). The number of asterisks specified is the number of significant digits. The asterisk must occupy the same place as the numbers in the file names.

## EnSight Gold Variable File Format

EnSight Gold variable files can either be `per_node` or `per_element`. They cannot be both. However, an EnSight model can have some variables which are `per_node` and others which are `per_element`.

### EnSight Gold Per\_Node Variable File Format

EnSight Gold variable files for `per_node` variables contain values for each unstructured node and for each structured node. First comes a single description line. Second comes a `part` line. Third comes a line containing the part number. Fourth comes a `coordinates` line or a `block` line. If a `coordinates` line, the value for each unstructured node of the part follows. If it is a scalar file, there is one value per node, while for vector files there are three values per node (output in the same component order as the coordinates, namely, all x components, then all y components, then all z components). If it is a `block` line, the value(s) for each structured node follows. The values for each node of the structured block are output in the same IJK order as the coordinates. (The number of nodes in the part are obtained from the corresponding EnSight Gold geometry file.)

*Note: If the geometry of given part is **empty**, nothing for that part needs to be in the variable file.*

#### C Binary form:

##### SCALAR FILE:

```

description line 1           80 chars
part                        80 chars
#                            1 int
coordinates                  80 chars
s_n1 s_n2 ... s_nn          nn floats
part                         80 chars
.
.
part                        80 chars
#                            1 int
block                        # nn = i*j*k 80 chars
s_n1 s_n2 ... s_nn          nn floats

```

##### VECTOR FILE:

```

description line 1           80 chars
part                        80 chars
#                            1 int
coordinates                  80 chars
vx_n1 vx_n2 ... vx_nn       nn floats
vy_n1 vy_n2 ... vy_nn       nn floats
vz_n1 vz_n2 ... vz_nn       nn floats
part                         80 chars
.
.
part                        80 chars
#                            1 int
block                        # nn = i*j*k 80 chars
vx_n1 vx_n2 ... vx_nn       nn floats

```

## 11.1 EnSight Gold Per\_Node Variable File Format

```
vy_n1 vy_n2 ... vy_nn      nn floats
vz_n1 vz_n2 ... vz_nn      nn floats
```

### TENSOR FILE:

```
description line 1      80 chars
part                    80 chars
#                        1 int
coordinates              80 chars
v11_n1 v11_n2 ... v11_nn  nn floats
v22_n1 v22_n2 ... v22_nn  nn floats
v33_n1 v33_n2 ... v33_nn  nn floats
v12_n1 v12_n2 ... v12_nn  nn floats
v13_n1 v13_n2 ... v13_nn  nn floats
v23_n1 v23_n2 ... v23_nn  nn floats
part                    80 chars
.
.
part                    80 chars
#                        1 int
block                    80 chars      # nn = i*j*k
v11_n1 v11_n2 ... v11_nn  nn floats
v22_n1 v22_n2 ... v22_nn  nn floats
v33_n1 v33_n2 ... v33_nn  nn floats
v12_n1 v12_n2 ... v12_nn  nn floats
v13_n1 v13_n2 ... v13_nn  nn floats
v23_n1 v23_n2 ... v23_nn  nn floats
```

### TENSOR9 FILE:

```
description line 1      80 chars
part                    80 chars
#                        1 int
coordinates              80 chars
v11_n1 v11_n2 ... v11_nn  nn floats
v12_n1 v12_n2 ... v12_nn  nn floats
v13_n1 v13_n2 ... v13_nn  nn floats
v21_n1 v21_n2 ... v21_nn  nn floats
v22_n1 v22_n2 ... v22_nn  nn floats
v23_n1 v23_n2 ... v23_nn  nn floats
v31_n1 v31_n2 ... v31_nn  nn floats
v32_n1 v32_n2 ... v32_nn  nn floats
v33_n1 v33_n2 ... v33_nn  nn floats
part                    80 chars
.
.
part                    80 chars
#                        1 int
block                    80 chars      # nn = i*j*k
v11_n1 v11_n2 ... v11_nn  nn floats
v12_n1 v12_n2 ... v12_nn  nn floats
v13_n1 v13_n2 ... v13_nn  nn floats
v21_n1 v21_n2 ... v21_nn  nn floats
v22_n1 v22_n2 ... v22_nn  nn floats
v23_n1 v23_n2 ... v23_nn  nn floats
v21_n1 v21_n2 ... v21_nn  nn floats
v22_n1 v22_n2 ... v22_nn  nn floats
v23_n1 v23_n2 ... v23_nn  nn floats
```

### COMPLEX SCALAR FILES (Real and/or Imaginary):



description line 1	80 chars
part	80 chars
#	1 int
coordinates	80 chars
s_n1 s_n2 ... s_nn	nn floats
part	80 chars
.	
.	
part	80 chars
#	1 int
block	# nn = i*j*k
s_n1 s_n2 ... s_nn	nn floats

**COMPLEX VECTOR FILES (Real and/or Imaginary):**

description line 1	80 chars
part	80 chars
#	1 int
coordinates	80 chars
vx_n1 vx_n2 ... vx_nn	nn floats
vy_n1 vy_n2 ... vy_nn	nn floats
vz_n1 vz_n2 ... vz_nn	nn floats
part	80 chars
.	
.	
part	80 chars
#	1 int
block	# nn = i*j*k
vx_n1 vx_n2 ... vx_nn	nn floats
vy_n1 vy_n2 ... vy_nn	nn floats
vz_n1 vz_n2 ... vz_nn	nn floats

**Fortran Binary form:****SCALAR FILE:**

'description line 1'	80 chars
'part'	80 chars
'#'	1 int
'coordinates'	80 chars
's_n1 s_n2 ... s_nn'	nn floats
'part'	80 chars
.	
.	
'part'	80 chars
'#'	1 int
'block'	# nn = i*j*k
's_n1 s_n2 ... s_nn'	nn floats

**VECTOR FILE:**

'description line 1'	80 chars
'part'	80 chars
'#'	1 int
'coordinates'	80 chars
'vx_n1 vx_n2 ... vx_nn'	nn floats

## 11.1 EnSight Gold Per\_Node Variable File Format

```

'vy_n1 vy_n2 ... vy_nn'          nn floats
'vz_n1 vz_n2 ... vz_nn'          nn floats
'part'                            80 chars
.
.
'part'                            80 chars
'#'                               1 int
'block'                          # nn = i*j*k 80 chars
'vx_n1 vx_n2 ... vx_nn'          nn floats
'vy_n1 vy_n2 ... vy_nn'          nn floats
'vz_n1 vz_n2 ... vz_nn'          nn floats

```

### TENSOR FILE:

```

'description line 1'              80 chars
'part'                            80 chars
'#'                               1 int
'coordinates'                     80 chars
'v11_n1 v11_n2 ... v11_nn'        nn floats
'v22_n1 v22_n2 ... v22_nn'        nn floats
'v33_n1 v33_n2 ... v33_nn'        nn floats
'v12_n1 v12_n2 ... v12_nn'        nn floats
'v13_n1 v13_n2 ... v13_nn'        nn floats
'v23_n1 v23_n2 ... v23_nn'        nn floats
'part'                            80 chars
.
.
'part'                            80 chars
'#'                               1 int
'block'                          # nn = i*j*k 80 chars
'v11_n1 v11_n2 ... v11_nn'        nn floats
'v22_n1 v22_n2 ... v22_nn'        nn floats
'v33_n1 v33_n2 ... v33_nn'        nn floats
'v12_n1 v12_n2 ... v12_nn'        nn floats
'v13_n1 v13_n2 ... v13_nn'        nn floats
'v23_n1 v23_n2 ... v23_nn'        nn floats

```

### TENSOR9 FILE:

```

'description line 1'              80 chars
'part'                            80 chars
'#'                               1 int
'coordinates'                     80 chars
'v11_n1 v11_n2 ... v11_nn'        nn floats
'v12_n1 v12_n2 ... v12_nn'        nn floats
'v13_n1 v13_n2 ... v13_nn'        nn floats
'v21_n1 v21_n2 ... v21_nn'        nn floats
'v22_n1 v22_n2 ... v22_nn'        nn floats
'v23_n1 v23_n2 ... v23_nn'        nn floats
'v31_n1 v31_n2 ... v31_nn'        nn floats
'v32_n1 v32_n2 ... v32_nn'        nn floats
'v33_n1 v33_n2 ... v33_nn'        nn floats
'part'                            80 chars
.
.
'part'                            80 chars
'#'                               1 int
'block'                          # nn = i*j*k 80 chars
'v11_n1 v11_n2 ... v11_nn'        nn floats
'v12_n1 v12_n2 ... v12_nn'        nn floats

```

'v13_n1 v13_n2 ... v13_nn'	nn floats
'v21_n1 v21_n2 ... v21_nn'	nn floats
'v22_n1 v22_n2 ... v22_nn'	nn floats
'v23_n1 v23_n2 ... v23_nn'	nn floats
'v31_n1 v31_n2 ... v31_nn'	nn floats
'v32_n1 v32_n2 ... v32_nn'	nn floats
'v33_n1 v33_n2 ... v33_nn'	nn floats

**COMPLEX SCALAR FILES (Real and/or Imaginary):**

'description line 1'	80 chars
'part'	80 chars
'#'	1 int
'coordinates'	80 chars
's_n1 s_n2 ... s_nn'	nn floats
'part'	80 chars
.	
.	
'part'	80 chars
'#'	1 int
'block' # nn = i*j*k	80 chars
's_n1 s_n2 ... s_nn'	nn floats

**COMPLEX VECTOR FILES (Real and/or Imaginary):**

'description line 1'	80 chars
'part'	80 chars
'#'	1 int
'coordinates'	80 chars
'vx_n1 vx_n2 ... vx_nn'	nn floats
'vy_n1 vy_n2 ... vy_nn'	nn floats
'vz_n1 vz_n2 ... vz_nn'	nn floats
'part'	80 chars
.	
.	
'part'	80 chars
'#'	1 int
'block' # nn = i*j*k	80 chars
'vx_n1 vx_n2 ... vx_nn'	nn floats
'vy_n1 vy_n2 ... vy_nn'	nn floats
'vz_n1 vz_n2 ... vz_nn'	nn floats

**ASCII form:****SCALAR FILE:**

description line 1	A (max of 79 typ)
part	A
#	I10
coordinates	A
s_n1	E12.5 1/line (nn)
s_n2	
.	
.	
s_nn	
part	A
.	

## 11.1 EnSight Gold Per\_Node Variable File Format

```

.
part A
# I10
block # nn = i*j*k A
s_n1 E12.5 1/line (nn)
s_n2
.
.
s_nn

```

### VECTOR FILE:

```

description line 1 A (max of 79 typ)
part A
# I10
coordinates A
vx_n1 E12.5 1/line (nn)
vx_n2
.
.
vx_nn
vy_n1 E12.5 1/line (nn)
vy_n2
.
.
vy_nn
vz_n1 E12.5 1/line (nn)
vz_n2
.
.
vz_nn
part A
.
.
part A
# I10
block # nn = i*j*k A
vx_n1 E12.5 1/line (nn)
vx_n2
.
.
vx_nn
vy_n1 E12.5 1/line (nn)
vy_n2
.
.
vy_nn
vz_n1 E12.5 1/line (nn)
vz_n2
.
.
vz_nn

```

### TENSOR FILE:

```

description line 1 A (max of 79 typ)
part A
# I10
coordinates A

```

```

v11_n1          E12.5  1/line (nn)
v11_n2
.
.
v11_nn
v22_n1          E12.5  1/line (nn)
v22_n2
.
.
v22_nn
v33_n1          E12.5  1/line (nn)
v33_n2
.
.
v33_nn
v12_n1          E12.5  1/line (nn)
v12_n2
.
.
v12_nn
v13_n1          E12.5  1/line (nn)
v13_n2
.
.
v13_nn
v23_n1          E12.5  1/line (nn)
v23_n2
.
.
v23_nn
part            A
.
.
part            A
#               I10
block           # nn = i*j*k  A
v11_n1          E12.5  1/line (nn)
v11_n2
.
.
v11_nn
v22_n1          E12.5  1/line (nn)
v22_n2
.
.
v22_nn
v33_n1          E12.5  1/line (nn)
v33_n2
.
.
v33_nn
v12_n1          E12.5  1/line (nn)
v12_n2
.
.
v12_nn
v13_n1          E12.5  1/line (nn)
v13_n2
.
.
v13_nn

```

## 11.1 EnSight Gold Per\_Node Variable File Format

```

v23_n1          E12.5  1/line (nn)
v23_n2
.
.
v23_nn

```

### TENSOR9 FILE:

```

description line 1      A (max of 79 typ)
part                    A
#                       I10
coordinates            A
v11_n1                 E12.5  1/line (nn)
v11_n2
.
.
v11_nn
v12_n1                 E12.5  1/line (nn)
v12_n2
.
.
v12_nn
v13_n1                 E12.5  1/line (nn)
v13_n2
.
.
v13_nn
v21_n1                 E12.5  1/line (nn)
v21_n2
.
.
v21_nn
v22_n1                 E12.5  1/line (nn)
v22_n2
.
.
v22_nn
v23_n1                 E12.5  1/line (nn)
v23_n2
.
.
v23_nn
v31_n1                 E12.5  1/line (nn)
v31_n2
.
.
v31_nn
v32_n1                 E12.5  1/line (nn)
v32_n2
.
.
v32_nn
v33_n1                 E12.5  1/line (nn)
v33_n2
.
.
v33_nn
part                    A
.
.
part                    A

```

```

# I10
block # nn = i*j*k A
v11_n1 E12.5 1/line (nn)
v11_n2
.
.
v11_nn
v12_n1 E12.5 1/line (nn)
v12_n2
.
.
v12_nn
v13_n1 E12.5 1/line (nn)
v13_n2
.
.
v13_nn
v21_n1 E12.5 1/line (nn)
v21_n2
.
.
v21_nn
v22_n1 E12.5 1/line (nn)
v22_n2
.
.
v22_nn
v23_n1 E12.5 1/line (nn)
v23_n2
.
.
v23_nn
v31_n1 E12.5 1/line (nn)
v31_n2
.
.
v31_nn
v32_n1 E12.5 1/line (nn)
v32_n2
.
.
v32_nn
v33_n1 E12.5 1/line (nn)
v33_n2
.
.
v33_nn

```

**COMPLEX SCALAR FILES (Real and/or Imaginary):**

```

description line 1 A (max of 79 typ)
part A
# I10
coordinates A
s_n1 E12.5 1/line (nn)
s_n2
.
.
s_nn
part A

```

## 11.1 EnSight Gold Per\_Node Variable File Format

```

.
.
part A
# I10
block # nn = i*j*k A
s_n1 E12.5 1/line (nn)
s_n2
.
.
s_nn

```

### COMPLEX VECTOR FILES (Real and/or Imaginary):

```

description line 1 A (max of 79 typ)
part A
# I10
coordinates A
vx_n1 E12.5 1/line (nn)
vx_n2
.
.
vx_nn
vy_n1 E12.5 1/line (nn)
vy_n2
.
.
vy_nn
vz_n1 E12.5 1/line (nn)
vz_n2
.
.
vz_nn
part A
.
.
part A
# I10
block # nn = i*j*k A
vx_n1 E12.5 1/line (nn)
vx_n2
.
.
vx_nn
vy_n1 E12.5 1/line (nn)
vy_n2
.
.
vy_nn
vz_n1 E12.5 1/line (nn)
vz_n2
.
.
vz_nn

```



The following variable file examples reflect scalar, vector, tensor, and complex variable values *per node* for the previously defined EnSight6 Gold Geometry File Example with 11 defined unstructured nodes and a 2x3x2 structured Part (Part number 3). The values are summarized in the following table.

*Note:* These are the same values as listed in the EnSight6 *per\_node* variable file section. Subsequently, the following example files contain the same data as the example files given in the EnSight6 section - only they are listed in gold format. (No asymmetric tensor example data given)

	Node Index	Node Id	Scalar Value	Vector Values	Tensor (2nd order symm.) Values	ComplexScalar	
						Real Value	Imaginary Value
<b>Unstructured</b>							
	1	15	(1.)	(1.1, 1.2, 1.3)	(1.1, 1.2, 1.3, 1.4, 1.5, 1.6)	(1.1)	(1.2)
	2	31	(2.)	(2.1, 2.2, 2.3)	(2.1, 2.2, 2.3, 2.4, 2.5, 2.6)	(2.1)	(2.2)
	3	20	(3.)	(3.1, 3.2, 3.3)	(3.1, 3.2, 3.3, 3.4, 3.5, 3.6)	(3.1)	(3.2)
	4	40	(4.)	(4.1, 4.2, 4.3)	(4.1, 4.2, 4.3, 4.4, 4.5, 4.6)	(4.1)	(4.2)
	5	22	(5.)	(5.1, 5.2, 5.3)	(5.1, 5.2, 5.3, 5.4, 5.5, 5.6)	(5.1)	(5.2)
	6	44	(6.)	(6.1, 6.2, 6.3)	(6.1, 6.2, 6.3, 6.4, 6.5, 6.6)	(6.1)	(6.2)
	7	55	(7.)	(7.1, 7.2, 7.3)	(7.1, 7.2, 7.3, 7.4, 7.5, 7.6)	(7.1)	(7.2)
	8	60	(8.)	(8.1, 8.2, 8.3)	(8.1, 8.2, 8.3, 8.4, 8.5, 8.6)	(8.1)	(8.2)
	9	61	(9.)	(9.1, 9.2, 9.3)	(9.1, 9.2, 9.3, 9.4, 9.5, 9.6)	(9.1)	(9.2)
	10	62	(10.)	(10.1,10.2,10.3)	(10.1,10.2,10.3,10.4,10.5,10.6)	(10.1)	(10.2)
	11	63	(11.)	(11.1,11.2,11.3)	(11.1,11.2,11.3,11.4,11.5,11.6)	(11.1)	(11.2)
<b>Structured</b>							
	1	1	(1.)	(1.1, 1.2, 1.3)	(1.1, 1.2, 1.3, 1.4, 1.5, 1.6)	(1.1)	(1.2)
	2	2	(2.)	(2.1, 2.2, 2.3)	(2.1, 2.2, 2.3, 2.4, 2.5, 2.6)	(2.1)	(2.2)
	3	3	(3.)	(3.1, 3.2, 3.3)	(3.1, 3.2, 3.3, 3.4, 3.5, 3.6)	(3.1)	(3.2)
	4	4	(4.)	(4.1, 4.2, 4.3)	(4.1, 4.2, 4.3, 4.4, 4.5, 4.6)	(4.1)	(4.2)
	5	5	(5.)	(5.1, 5.2, 5.3)	(5.1, 5.2, 5.3, 5.4, 5.5, 5.6)	(5.1)	(5.2)
	6	6	(6.)	(6.1, 6.2, 6.3)	(6.1, 6.2, 6.3, 6.4, 6.5, 6.6)	(6.1)	(6.2)
	7	7	(7.)	(7.1, 7.2, 7.3)	(7.1, 7.2, 7.3, 7.4, 7.5, 7.6)	(7.1)	(7.2)
	8	8	(8.)	(8.1, 8.2, 8.3)	(8.1, 8.2, 8.3, 8.4, 8.5, 8.6)	(8.1)	(8.2)
	9	9	(9.)	(9.1, 9.2, 9.3)	(9.1, 9.2, 9.3, 9.4, 9.5, 9.6)	(9.1)	(9.2)
	10	10	(10.)	(10.1,10.2,10.3)	(10.1,10.2,10.3,10.4,10.5,10.6)	(10.1)	(10.2)
	11	11	(11.)	(11.1,11.2,11.3)	(11.1,11.2,11.3,11.4,11.5,11.6)	(11.1)	(11.2)
	12	12	(12.)	(12.1,12.2,12.3)	(12.1,12.2,12.3,12.4,12.5,12.6)	(12.1)	(12.2)

**Per\_node (Scalar) Variable Example 1:** This shows an ASCII scalar file (`engold.Nsca`) for the gold geometry example.

```
Per_node scalar values for the EnSight Gold geometry example
part
  1
coordinates
1.00000E+00
3.00000E+00
4.00000E+00
5.00000E+00
6.00000E+00
7.00000E+00
8.00000E+00
9.00000E+00
1.00000E+01
1.10000E+01
part
  2
coordinates
1.00000E+00
2.00000E+00
```

## 11.1 EnSight Gold Per\_Node Variable File Format

```
part
    3
block
1.00000E+00
2.00000E+00
3.00000E+00
4.00000E+00
5.00000E+00
6.00000E+00
7.00000E+00
8.00000E+00
9.00000E+00
1.00000E+01
1.10000E+01
1.20000E+01
```

**Per\_node (Vector) Variable Example 2:** This example shows an ASCII vector file (`engold.Nvec`) for the gold geometry example.

Per\_node vector values for the EnSight Gold geometry example

```
part
    1
coordinates
1.10000E+00
3.10000E+00
4.10000E+00
5.10000E+00
6.10000E+00
7.10000E+00
8.10000E+00
9.10000E+00
1.01000E+01
1.11000E+01
1.20000E+00
3.20000E+00
4.20000E+00
5.20000E+00
6.20000E+00
7.20000E+00
8.20000E+00
9.20000E+00
1.02000E+01
1.12000E+01
1.30000E+00
3.30000E+00
4.30000E+00
5.30000E+00
6.30000E+00
7.30000E+00
8.30000E+00
9.30000E+00
1.03000E+01
1.13000E+01
part
    2
coordinates
1.10000E+00
2.10000E+00
1.20000E+00
2.20000E+00
1.30000E+00
2.30000E+00
part
    3
block
1.10000E+00
```

```

2.10000E+00
3.10000E+00
4.10000E+00
5.10000E+00
6.10000E+00
7.10000E+00
8.10000E+00
9.10000E+00
1.01000E+01
1.11000E+01
1.21000E+01
1.20000E+00
2.20000E+00
3.20000E+00
4.20000E+00
5.20000E+00
6.20000E+00
7.20000E+00
8.20000E+00
9.20000E+00
1.02000E+01
1.12000E+01
1.22000E+01
1.30000E+00
2.30000E+00
3.30000E+00
4.30000E+00
5.30000E+00
6.30000E+00
7.30000E+00
8.30000E+00
9.30000E+00
1.03000E+01
1.13000E+01
1.23000E+01

```

**Per\_node (Tensor) Variable Example 3:** This example shows an ASCII 2nd order symmetric tensor file (engold.Nten) for the gold geometry example.

Per\_node symmetric tensor values for the EnSight Gold geometry example  
part

```

1
coordinates
1.10000E+00
3.10000E+00
4.10000E+00
5.10000E+00
6.10000E+00
7.10000E+00
8.10000E+00
9.10000E+00
1.01000E+01
1.11000E+01
1.20000E+00
3.20000E+00
4.20000E+00
5.20000E+00
6.20000E+00
7.20000E+00
8.20000E+00
9.20000E+00
1.02000E+01
1.12000E+01
1.30000E+00
3.30000E+00
4.30000E+00

```

## 11.1 EnSight Gold Per\_Node Variable File Format

```
5.30000E+00
6.30000E+00
7.30000E+00
8.30000E+00
9.30000E+00
1.03000E+01
1.13000E+01
1.40000E+00
3.40000E+00
4.40000E+00
5.40000E+00
6.40000E+00
7.40000E+00
8.40000E+00
9.40000E+00
1.04000E+01
1.14000E+01
1.50000E+00
3.50000E+00
4.50000E+00
5.50000E+00
6.50000E+00
7.50000E+00
8.50000E+00
9.50000E+00
1.05000E+01
1.15000E+01
1.60000E+00
3.60000E+00
4.60000E+00
5.60000E+00
6.60000E+00
7.60000E+00
8.60000E+00
9.60000E+00
1.06000E+01
1.16000E+01
part
    2
coordinates
1.10000E+00
2.10000E+00
1.20000E+00
2.20000E+00
1.30000E+00
2.30000E+00
1.40000E+00
2.40000E+00
1.50000E+00
2.50000E+00
1.60000E+00
2.60000E+00
part
    3
block
1.10000E+00
2.10000E+00
3.10000E+00
4.10000E+00
5.10000E+00
6.10000E+00
7.10000E+00
8.10000E+00
9.10000E+00
1.01000E+01
1.11000E+01
1.21000E+01
```

1.20000E+00  
2.20000E+00  
3.20000E+00  
4.20000E+00  
5.20000E+00  
6.20000E+00  
7.20000E+00  
8.20000E+00  
9.20000E+00  
1.02000E+01  
1.12000E+01  
1.22000E+01  
1.30000E+00  
2.30000E+00  
3.30000E+00  
4.30000E+00  
5.30000E+00  
6.30000E+00  
7.30000E+00  
8.30000E+00  
9.30000E+00  
1.03000E+01  
1.13000E+01  
1.23000E+01  
1.40000E+00  
2.40000E+00  
3.40000E+00  
4.40000E+00  
5.40000E+00  
6.40000E+00  
7.40000E+00  
8.40000E+00  
9.40000E+00  
1.04000E+01  
1.14000E+01  
1.24000E+01  
1.50000E+00  
2.50000E+00  
3.50000E+00  
4.50000E+00  
5.50000E+00  
6.50000E+00  
7.50000E+00  
8.50000E+00  
9.50000E+00  
1.05000E+01  
1.15000E+01  
1.25000E+01  
1.60000E+00  
2.60000E+00  
3.60000E+00  
4.60000E+00  
5.60000E+00  
6.60000E+00  
7.60000E+00  
8.60000E+00  
9.60000E+00  
1.06000E+01  
1.16000E+01  
1.26000E+01

Per\_node (Complex) Variable Example 4: This example shows ASCII complex real (`engold.Ncmp_r`) and imaginary (`engold.Ncmp_i`) *scalar* files for the gold geometry example. (The same methodology would apply for complex real and imaginary *vector* files.)

Real scalar File:

```
Per_node complex real scalar values for the EnSight Gold geometry example
part
    1
coordinates
    1.10000E+00
    3.10000E+00
    4.10000E+00
    5.10000E+00
    6.10000E+00
    7.10000E+00
    8.10000E+00
    9.10000E+00
    1.01000E+01
    1.11000E+01
part
    2
coordinates
    1.10000E+00
    2.10000E+00
part
    3
block
    1.10000E+00
    2.10000E+00
    3.10000E+00
    4.10000E+00
    5.10000E+00
    6.10000E+00
    7.10000E+00
    8.10000E+00
    9.10000E+00
    1.01000E+01
    1.11000E+01
    1.21000E+01
```

Imaginary scalar File:

```
Per_node complex imaginary scalar values for the EnSight Gold geometry example
part
    1
coordinates
    1.20000E+00
    3.20000E+00
    4.20000E+00
    5.20000E+00
    6.20000E+00
    7.20000E+00
    8.20000E+00
    9.20000E+00
    1.02000E+01
    1.12000E+01
part
    2
coordinates
    1.20000E+00
    2.20000E+00
part
    3
block
```

```

1.20000E+00
2.20000E+00
3.20000E+00
4.20000E+00
5.20000E+00
6.20000E+00
7.20000E+00
8.20000E+00
9.20000E+00
1.02000E+01
1.12000E+01
1.22000E+01

```

## EnSight Gold Per\_Element Variable File Format

EnSight Gold variable files for per\_element variables contain values for each element of designated types of designated Parts. First comes a single description line. Second comes a Part line. Third comes a line containing the part number. Fourth comes an element type line and then comes the value for each element of that type and part. If it is a scalar variable, there is one value per element, while for vector variables there are three values per element. (The number of elements of the given type are obtained from the corresponding EnSight Gold geometry file.)

*Note: If the geometry of given part is **empty**, nothing for that part needs to be in the variable file.*

### C Binary form:

#### SCALAR FILE:

```

description line 1          80 chars
part                       80 chars
#                           1 int
element type               80 chars
s_e1 s_e2 ... s_ne        ne floats
element type               80 chars
.
.
part                       80 chars
.
.
part                       80 chars
#                           1 int
block                       80 chars      # nn = (i-1)*(j-1)*(k-1)
s_n1 s_n2 ... s_nn        nn floats

```

#### VECTOR FILE:

```

description line 1          80 chars
part                       80 chars
#                           1 int
element type               80 chars
vx_e1 vx_e2 ... vx_ne     ne floats
vy_e1 vy_e2 ... vy_ne     ne floats
vz_e1 vz_e2 ... vz_ne     ne floats

```

## 11.1 EnSight Gold Per\_Element Variable File Format

```

element type          80 chars
.
.
part                  80 chars
.
.
part                  80 chars
#                      1 int
block                 # nn = (i-1)*(j-1)*(k-1) 80 chars
vx_n1 vx_n2 ... vx_nn nn floats
vy_n1 vy_n2 ... vy_nn nn floats
vz_n1 vz_n2 ... vz_nn nn floats

```

### TENSOR FILE:

```

description line 1    80 chars
part                  80 chars
#                      1 int
element type          80 chars
v11_e1 v11_e2 ... v11_ne ne floats
v22_e1 v22_e2 ... v22_ne ne floats
v33_e1 v33_e2 ... v33_ne ne floats
v12_e1 v12_e2 ... v12_ne ne floats
v13_e1 v13_e2 ... v13_ne ne floats
v23_e1 v23_e2 ... v23_ne ne floats
element type          80 chars
.
.
part                  80 chars
.
.
part                  80 chars
#                      1 int
block                 # nn = (i-1)*(j-1)*(k-1) 80 chars
v11_n1 v11_n2 ... v11_nn nn floats
v22_n1 v22_n2 ... v22_nn nn floats
v33_n1 v33_n2 ... v33_nn nn floats
v12_n1 v12_n2 ... v12_nn nn floats
v13_n1 v13_n2 ... v13_nn nn floats
v23_n1 v23_n2 ... v23_nn nn floats

```

### TENSOR9 FILE:

```

description line 1    80 chars
part                  80 chars
#                      1 int
element type          80 chars
v11_e1 v11_e2 ... v11_ne ne floats
v12_e1 v12_e2 ... v12_ne ne floats
v13_e1 v13_e2 ... v13_ne ne floats
v21_e1 v21_e2 ... v21_ne ne floats
v22_e1 v22_e2 ... v22_ne ne floats
v23_e1 v23_e2 ... v23_ne ne floats
v31_e1 v31_e2 ... v31_ne ne floats
v32_e1 v32_e2 ... v32_ne ne floats
v33_e1 v33_e2 ... v33_ne ne floats
element type          80 chars
.
.

```



part		80 chars
.		
.		
part		80 chars
#		1 int
block	# nn = (i-1)*(j-1)*(k-1)	80 chars
v11_n1 v11_n2 ... v11_nn		nn floats
v12_n1 v12_n2 ... v12_nn		nn floats
v13_n1 v13_n2 ... v13_nn		nn floats
v21_n1 v21_n2 ... v21_nn		nn floats
v22_n1 v22_n2 ... v22_nn		nn floats
v23_n1 v23_n2 ... v23_nn		nn floats
v31_n1 v31_n2 ... v31_nn		nn floats
v32_n1 v32_n2 ... v32_nn		nn floats
v33_n1 v33_n2 ... v33_nn		nn floats

**COMPLEX SCALAR FILES (Real and/or Imaginary):**

description line 1		80 chars
part		80 chars
#		1 int
element type		80 chars
s_e1 s_e2 ... s_ne		ne floats
element type		80 chars
.		
.		
part		80 chars
.		
.		
part		80 chars
#		1 int
block	# nn = (i-1)*(j-1)*(k-1)	80 chars
s_n1 s_n2 ... s_nn		nn floats

**COMPLEX VECTOR FILES (Real and/or Imaginary):**

description line 1		80 chars
part		80 chars
#		1 int
element type		80 chars
vx_e1 vx_e2 ... vx_ne		ne floats
vy_e1 vy_e2 ... vy_ne		ne floats
vz_e1 vz_e2 ... vz_ne		ne floats
element type		80 chars
.		
.		
part		80 chars
.		
.		
part		80 chars
#		1 int
block	# nn = (i-1)*(j-1)*(k-1)	80 chars
vx_n1 vx_n2 ... vx_nn		nn floats
vy_n1 vy_n2 ... vy_nn		nn floats
vz_n1 vz_n2 ... vz_nn		nn floats

**Fortran Binary form:**

SCALAR FILE:

## 11.1 EnSight Gold Per\_Element Variable File Format

```

'description line 1'           80 chars
'part'                        80 chars
'#'                            1 int
'element type'                80 chars
's_e1 s_e2 ... s_ne'         ne floats
'element type'                80 chars
.
.
'part'                        80 chars
.
.
'part'                        80 chars
'#'                            1 int
'block'                        # nn = (i-1)*(j-1)*(k-1) 80 chars
's_n1 s_n2 ... s_nn'         nn floats

```

### VECTOR FILE:

```

'description line 1'           80 chars
'part'                        80 chars
'#'                            1 int
'element type'                80 chars
'vx_e1 vx_e2 ... vx_ne'      ne floats
'vy_e1 vy_e2 ... vy_ne'      ne floats
'vz_e1 vz_e2 ... vz_ne'      ne floats
'element type'                80 chars
.
.
'part'                        80 chars
.
.
'part'                        80 chars
'#'                            1 int
'block'                        # nn = (i-1)*(j-1)*(k-1) 80 chars
'vx_n1 vx_n2 ... vx_nn'      nn floats
'vy_n1 vy_n2 ... vy_nn'      nn floats
'vz_n1 vz_n2 ... vz_nn'      nn floats

```

### TENSOR FILE:

```

'description line 1'           80 chars
'part'                        80 chars
'#'                            1 int
'element type'                80 chars
'v11_e1 v11_e2 ... v11_ne'   ne floats
'v22_e1 v22_e2 ... v22_ne'   ne floats
'v33_e1 v33_e2 ... v33_ne'   ne floats
'v12_e1 v12_e2 ... v12_ne'   ne floats
'v13_e1 v13_e2 ... v13_ne'   ne floats
'v23_e1 v23_e2 ... v23_ne'   ne floats
'element type'                80 chars
.
.
'part'                        80 chars
.
.
'part'                        80 chars
'#'                            1 int

```

```

'block'                # nn = (i-1)*(j-1)*(k-1)          80 chars
'v11_n1 v11_n2 ... v11_nn'          nn floats
'v22_n1 v22_n2 ... v22_nn'          nn floats
'v33_n1 v33_n2 ... v33_nn'          nn floats
'v12_n1 v12_n2 ... v12_nn'          nn floats
'v13_n1 v13_n2 ... v13_nn'          nn floats
'v23_n1 v23_n2 ... v23_nn'          nn floats

```

#### TENSOR9 FILE:

```

'description line 1'          80 chars
'part'                        80 chars
'#'                            1 int
'element type'                80 chars
'v11_e1 v11_e2 ... v11_ne'      ne floats
'v12_e1 v12_e2 ... v12_ne'      ne floats
'v13_e1 v13_e2 ... v13_ne'      ne floats
'v21_e1 v21_e2 ... v21_ne'      ne floats
'v22_e1 v22_e2 ... v22_ne'      ne floats
'v23_e1 v23_e2 ... v23_ne'      ne floats
'v31_e1 v31_e2 ... v31_ne'      ne floats
'v32_e1 v32_e2 ... v32_ne'      ne floats
'v33_e1 v33_e2 ... v33_ne'      ne floats
'element type'                80 chars
.
.
'part'                        80 chars
.
.
'part'                        80 chars
'#'                            1 int
'block'                # nn = (i-1)*(j-1)*(k-1)          80 chars
'v11_n1 v11_n2 ... v11_nn'          nn floats
'v12_n1 v12_n2 ... v12_nn'          nn floats
'v13_n1 v13_n2 ... v13_nn'          nn floats
'v21_n1 v21_n2 ... v21_nn'          nn floats
'v22_n1 v22_n2 ... v22_nn'          nn floats
'v23_n1 v23_n2 ... v23_nn'          nn floats
'v31_n1 v31_n2 ... v31_nn'          nn floats
'v32_n1 v32_n2 ... v32_nn'          nn floats
'v33_n1 v33_n2 ... v33_nn'          nn floats

```

#### COMPLEX SCALAR FILES (Real and/or Imaginary):

```

'description line 1'          80 chars
'part'                        80 chars
'#'                            1 int
'element type'                80 chars
's_e1 s_e2 ... s_ne'          ne floats
'element type'                80 chars
.
.
'part'                        80 chars
.
.
'part'                        80 chars
'#'                            1 int
'block'                # nn = (i-1)*(j-1)*(k-1)          80 chars

```

## 11.1 EnSight Gold Per\_Element Variable File Format

's\_n1 s\_n2 ... s\_nn' nn floats

### COMPLEX VECTOR FILES (Real and/or Imaginary):

```
'description line 1'      80 chars
'part'                  80 chars
'#'                    1 int
'element type`         80 chars
'vx_e1 vx_e2 ... vx_ne' ne floats
'vy_e1 vy_e2 ... vy_ne' ne floats
'vz_e1 vz_e2 ... vz_ne' ne floats
'element type`         80 chars
.
.
'part'                  80 chars
.
.
'part'                  80 chars
'#'                    1 int
'block'                # nn = (i-1)*(j-1)*(k-1) 80 chars
'vx_n1 vx_n2 ... vx_nn' nn floats
'vy_n1 vy_n2 ... vy_nn' nn floats
'vz_n1 vz_n2 ... vz_nn' nn floats
```

### ASCII form:

#### SCALAR FILE:

```
description line 1      A (max of 80 typ)
part                   A
#                      I10
element type          A
s_e1                  12.5  1/line (ne)
s_e2
.
.
s_ne
element type          A
.
.
part                   A
.
.
part                   A
#                      I10
block                  # nn = (i-1)*(j-1)*(k-1)  A
s_n1                  E12.5  1/line (nn)
s_n2
.
.
s_nn
```

#### VECTOR FILE:

```
description line 1      A (max of 80 typ)
part                   A
#                      I10
element type          A
```

```

vx_e1          E12.5  1/line (ne)
vx_e2
.
.
vx_ne
vy_e1          E12.5  1/line (ne)
vy_e2
.
.
vy_ne
vz_e1          E12.5  1/line (ne)
vz_e2
.
.
vz_ne
element type  A
.
.
part          A
.
.
part          A
#            I10
block        # nn = (i-1)*(j-1)*(k-1)  A
vx_n1        E12.5  1/line (nn)
vx_n2
.
.
vx_nn
vy_n1        E12.5  1/line (nn)
vy_n2
.
.
vy_nn
vz_n1        E12.5  1/line (nn)
vz_n2
.
.
vz_nn

```

Tensor File:

```

description line 1  A (max of 80 typ)
part              A
#                I10
element type      A
v11_e1           E12.5  1/line (ne)
v11_e2
.
.
v11_ne
v22_e1           E12.5  1/line (ne)
v22_e2
.
.
v22_ne
v33_e1           E12.5  1/line (ne)
v33_e2
.
.
v33_ne

```

## 11.1 EnSight Gold Per\_Element Variable File Format

```

v12_e1          E12.5  1/line (ne)
v12_e2
.
.
v12_ne
v13_e1          E12.5  1/line (ne)
v13_e2
.
.
v13_ne
v23_e1          E12.5  1/line (ne)
v23_e2
.
.
v23_ne
element type    A
.
.
part            A
.
.
part            A
#               I10
block           # nn = (i-1)*(j-1)*(k-1)  A
v11_n1          E12.5  1/line (nn)
v11_n2
.
.
v11_nn
v22_n1          E12.5  1/line (nn)
v22_n2
.
.
v22_nn
v33_n1          E12.5  1/line (nn)
v33_n2
.
.
v33_nn
v12_n1          E12.5  1/line (nn)
v12_n2
.
.
v12_nn
v13_n1          E12.5  1/line (nn)
v13_n2
.
.
v13_nn
v23_n1          E12.5  1/line (nn)
v23_n2
.
.
v23_nn

```

### TENSOR9 FILE:

```

description line 1  A (max of 80 typ)
part                A
#                   I10
element type        A

```

```

v11_e1          E12.5  1/line (ne)
v11_e2
.
.
v11_ne
v12_e1          E12.5  1/line (ne)
v12_e2
.
.
v12_ne
v13_e1          E12.5  1/line (ne)
v13_e2
.
.
v13_ne
v21_e1          E12.5  1/line (ne)
v21_e2
.
.
v21_ne
v22_e1          E12.5  1/line (ne)
v22_e2
.
.
v22_ne
v23_e1          E12.5  1/line (ne)
v23_e2
.
.
v23_ne
v31_e1          E12.5  1/line (ne)
v31_e2
.
.
v31_ne
v32_e1          E12.5  1/line (ne)
v32_e2
.
.
v32_ne
v33_e1          E12.5  1/line (ne)
v33_e2
.
.
v33_ne
element type   A
.
.
part           A
.
.
part           A
#              I10
block          # nn = (i-1)*(j-1)*(k-1)  A
v11_n1         E12.5  1/line (nn)
v11_n2
.
.
v11_nn
v12_n1         E12.5  1/line (nn)
v12_n2

```

## 11.1 EnSight Gold Per\_Element Variable File Format

```

.
.
v12_nn
v13_n1          E12.5  1/line (nn)
v13_n2
.
.
v13_nn
v21_n1          E12.5  1/line (nn)
v21_n2
.
.
v21_nn
v22_n1          E12.5  1/line (nn)
v22_n2
.
.
v22_nn
v23_n1          E12.5  1/line (nn)
v23_n2
.
.
v23_nn
v31_n1          E12.5  1/line (nn)
v31_n2
.
.
v31_nn
v32_n1          E12.5  1/line (nn)
v32_n2
.
.
v32_nn
v33_n1          E12.5  1/line (nn)
v33_n2
.
.
v33_nn

```

### COMPLEX SCALAR FILES (Real and/or Imaginary):

```

description line 1      A (max of 80 typ)
part                   A
#                      I10
element type           A
s_e1                   12.5  1/line (ne)
s_e2
.
.
s_ne
element type           A
.
.
part                   A
.
.
part                   A
#                      I10
block                  # nn = (i-1)*(j-1)*(k-1)  A

```



```

s_n1                      E12.5  1/line (nn)
s_n2
.
.
s_nn

```

COMPLEX VECTOR FILES (Real and/or Imaginary):

```

description line 1        A (max of 80 typ)
part                     A
#                         I10
element type             A
vx_e1                    E12.5  1/line (ne)
vx_e2
.
.
vx_ne
vy_e1                    E12.5  1/line (ne)
vy_e2
.
.
vy_ne
vz_e1                    E12.5  1/line (ne)
vz_e2
.
.
vz_ne
element type             A
.
.
part                     A
.
.
part                     A
#                         I10
block                    # nn = (i-1)*(j-1)*(k-1)  A
vx_n1                    E12.5  1/line (nn)
vx_n2
.
.
vx_nn
vy_n1                    E12.5  1/line (nn)
vy_n2
.
.
vy_nn
vz_n1                    E12.5  1/line (nn)
vz_n2
.
.
vz_nn

```

The following variable file examples reflect scalar, vector, tensor, and complex variable values *per element* for the previously defined EnSight Gold Geometry File Example with 11 defined unstructured nodes and a 2x3x2 structured Part (Part number 3). The values are summarized in the following table

*Note: These are the same values as listed in the EnSight6 per\_element variable file section. Subsequently, the following example files contain the same data as the example files in the EnSight6 section - only they are listed in gold format. (No asymmetric tensor example data given)*

	Element Index	Element Id	Scalar Value	Vector Values	Tensor (2nd order symm.) Values	Complex Scalar	
						Real Value	Imaginary Value
Unstructured							
bar2	1	101	(1.)	(1.1, 1.2, 1.3)	(1.1, 1.2, 1.3, 1.4, 1.5, 1.6)	(1.1)	(1.2)
tria3	1	102	(2.)	(2.1, 2.2, 2.3)	(2.1, 2.2, 2.3, 2.4, 2.5, 2.6)	(2.1)	(2.2)
	2	103	(3.)	(3.1, 3.2, 3.3)	(3.1, 3.2, 3.3, 3.4, 3.5, 3.6)	(3.1)	(3.2)
hexa8	1	104	(4.)	(4.1, 4.2, 4.3)	(4.1, 4.2, 4.3, 4.4, 4.5, 4.6)	(4.1)	(4.2)
Structured							
block	1	1	(5.)	(5.1, 5.2, 5.3)	(5.1, 5.2, 5.3, 5.4, 5.5, 5.6)	(5.1)	(5.2)

**Per\_element (Scalar) Variable Example 1:** This example shows an ASCII scalar file (`engold.Esca`) for the gold geometry example.

```
Per_elem scalar values for the EnSight Gold geometry example
part
    1
    tria3
    2.00000E+00
    3.00000E+00
    hexa8
    4.00000E+00
part
    2
    bar2
    1.00000E+00
part
    3
    block
    5.00000E+00
    6.00000E+00
```

**Per\_element (Vector) Variable Example 2:** This example shows an ASCII vector file (`engold.Evec`) for the gold geometry example.

```
Per_elem vector values for the EnSight Gold geometry example
part
    1
    tria3
    2.10000E+00
    3.10000E+00
    2.20000E+00
    3.20000E+00
```

```

2.30000E+00
3.30000E+00
hexa8
4.10000E+00
4.20000E+00
4.30000E+00
part
    2
bar2
1.10000E+00
1.20000E+00
1.30000E+00
part
    3
block
5.10000E+00
6.10000E+00
5.20000E+00
6.20000E+00
5.30000E+00
6.30000E+00

```

**Per\_element (Tensor) Variable Example3:** This example shows an ASCII 2nd order symmetric tensor file (`engold.Eten`) for the gold geometry example.

```

Per_lem symmetric tensor values for the EnSight Gold geometry example
part
    1
tria3
2.10000E+00
3.10000E+00
2.20000E+00
3.20000E+00
2.30000E+00
3.30000E+00
2.40000E+00
3.40000E+00
2.50000E+00
3.50000E+00
2.60000E+00
3.60000E+00
hexa8
4.10000E+00
4.20000E+00
4.30000E+00
4.40000E+00
4.50000E+00
4.60000E+00
part
    2
bar2
1.10000E+00
1.20000E+00
1.30000E+00
1.40000E+00
1.50000E+00
1.60000E+00
part
    3
block

```

## 11.1 EnSight Gold Per\_Element Variable File Format

```
5.10000E+00
6.10000E+00
5.20000E+00
6.20000E+00
5.30000E+00
6.30000E+00
5.40000E+00
6.40000E+00
5.50000E+00
6.50000E+00
5.60000E+00
6.60000E+00
```

**Per\_element (Complex) Variable Example 4:** This example shows ASCII complex real (`engold.Ecmp_r`) and imaginary (`engold.Ecmp_i`) *scalar* files for the gold geometry example. (The same methodology would apply for complex real and imaginary *vector* files.)

Real scalar File:

```
Per_elem complex real scalar values for the EnSight Gold geometry example
part
    1
    tria3
    2.10000E+00
    3.10000E+00
    hexa8
    4.10000E+00
part
    2
    bar2
    1.10000E+00
part
    3
    block
    5.10000E+00
    6.10000E+00
```

Imaginary scalar File:

```
Per_elem complex imaginary scalar values for the EnSight Gold geometry example
part
    1
    tria3
    2.20000E+00
    3.20000E+00
    hexa8
    4.20000E+00
part
    2
    bar2
    1.20000E+00
part
    3
    block
    5.20000E+00
    6.20000E+00
```

## EnSight Gold Undefined Variable Values Format

Undefined variable values are allowed in EnSight Gold scalar, vector, tensor and complex variable file formats. Undefined values are specified on a “per section” basis (i.e. `coordinates`, `element_type`, or `block`) in each EnSight Gold variable file. EnSight first parses any undefined keyword “undef” that may follow the sectional keyword (i.e. `coordinates undef`, `element_type undef`, or `block undef`) on its line. This indicates that the next floating point value is the undefined value used in that section. EnSight reads this undefined value, reads all subsequent variable values for that section; and then converts any undefined (file section) values to an internal undefined value (currently  $-1.345e-10$ ) recognized computationally by EnSight (Note: the internal, or computational, undefined value can be changed by the user via the “`test: change_undef_value`” command **before any data is read.**)

*Note: EnSight’s undefined capability is for variables only - not for geometry! Also, in determining internally whether a vector or tensor variable is undefined at a node or element, the first component is all that is examined. You cannot have some components defined and others undefined.*

The following `per_node` and `per_element` ASCII scalar files contain examples of undefined values. For your comparison, these two files are the files `engold.Nsca` and `engold.Esca` written with some undefined values specified. Note that the undefined values per section need not be the same value; rather, it may be any value - usually outside the interval range of the variable. *The same methodology applies to vector, tensor, and complex files.*

### C Binary form: (Per\_node)

SCALAR FILE:

```

description line 1           80 chars
part                        80 chars
#                            1 int
coordinates undef          80 chars
undef_value                 1 float
s_n1 s_n2 ... s_nn        nn floats
part                        80 chars
.
.
part                        80 chars
#                            1 int
block undef                 80 chars      # nn = i*j*k
undef_value                 1 float
s_n1 s_n2 ... s_nn        nn floats

```

### Fortran Binary form: (Per\_node)

SCALAR FILE:

```

'description line 1'       80 chars
'part'                    80 chars
'#'                        1 int
'coordinates undef'      80 chars
'undef_value'            1 float
's_n1 s_n2 ... s_nn'    nn floats
'part'                    80 chars

```

## 11.1 EnSight Gold Undefined Variable Values Format

```

.
.
`part'                                80 chars
`#'                                    1 int
`block undef'                         # nn = i*j*k    80 chars
`undef_value'                          1 float
`s_n1 s_n2 ... s_nn'                   nn floats

```

### ASCII form: (Per\_node)

#### SCALAR FILE:

```

description line 1                    A (max of 79 typ)
part                                  A
#                                    I10
coordinates undef                     A
undef_value                           E12.5
s_n1                                   E12.5  1/line (nn)
s_n2
.
.
s_nn
part                                  A
.
.
part                                  A
#                                    I10
block undef                           # nn = i*j*k    A
undef_value                           E12.5
s_n1                                   E12.5  1/line (nn)
s_n2
.
.
s_nn

```

Undefined per\_node (Scalar) Variable Example: This example shows undefined data in an ASCII scalar file (engold.Nsca\_u) for the gold geometry example.

```

Per_node undefined scalar values for the EnSight Gold geometry example
part
  1
coordinates undef
-1.00000E+04
-1.00000E+04
 3.00000E+00
 4.00000E+00
 5.00000E+00
 6.00000E+00
 7.00000E+00
 8.00000E+00
 9.00000E+00
1.00000E+01
1.10000E+01
part
  2
coordinates
 1.00000E+00
 2.00000E+00
part
  3

```

```

block undef
-1.23450E-10
 1.00000E+00
 2.00000E+00
 3.00000E+00
 4.00000E+00
 5.00000E+00
-1.23450E-10
 7.00000E+00
 8.00000E+00
 9.00000E+00
 1.00000E+01
 1.10000E+01
 1.20000E+01
    
```

**C Binary form: (Per\_element)**

SCALAR FILE:

```

description line 1           80 chars
part                        80 chars
#                            1 int
element type undef         80 chars
undef_value                 1 float
s_e1 s_e2 ... s_ne         ne floats
element type undef         80 chars
undef_value                 1 float
.
.
part                        80 chars
.
.
part                        80 chars
#                            1 int
block undef                 # nn = (i-1)*(j-1)*(k-1) 80 chars
undef_value                 1 float
s_n1 s_n2 ... s_nn         nn floats
    
```

**Fortran Binary form: (Per\_element)**

SCALAR FILE:

```

'description line 1'        80 chars
'part'                     80 chars
'#'                         1 int
'element type undef'       80 chars
'undef_value'              1 float
's_e1 s_e2 ... s_ne'       ne floats
'element type undef'       80 chars
'undef_value'              1 float
.
.
'part'                     80 chars
.
.
    
```

## 11.1 EnSight Gold Undefined Variable Values Format

```

`part'                                80 chars
`#'                                    1 int
`block undef'                         # nn = (i-1)*(j-1)*(k-1) 80 chars
`undef_value'                         1 float
`s_n1 s_n2 ... s_nn'                  nn floats

```

### ASCII form: (Per\_element)

#### SCALAR FILE:

```

description line 1                    A (max of 80 typ)
part                                  A
#                                     I10
element type undef                    A
undef_value                           E12.5
s_e1                                   E12.5 1/line (ne)
s_e2
.
.
s_ne
element type undef                    A
undef_value                           E12.5
.
.
part                                  A
.
.
part                                  A
#                                     I10
block undef                           # nn = (i-1)*(j-1)*(k-1) A
undef_value                           E12.5
s_n1                                   E12.5 1/line (nn)
s_n2
.
.
s_nn

```

**Undefined per\_element (Scalar) Variable Example:** This example shows undefined data in an ASCII scalar file (`engold.Esca_u`) for the gold geometry example.

```

Per_elem undefined scalar values for the EnSight Gold geometry example
part
    1
    tria3 undef
    -1.00000E+02
    2.00000E+00
    -1.00000E+02
    hexa8
    4.00000E+00
part
    2
    bar2
    1.00000E+00
part
    3
    block undef
    -1.23450E-10
    -1.23450E-10
    6.00000E+00

```



## EnSight Gold Partial Variable Values Format

Partial variable values are allowed in EnSight Gold scalar, vector, tensor and complex variable file formats. Partial values are specified on a “per section” basis (i.e. `coordinates`, `element_type`, or `block`) in each EnSight Gold variable file. EnSight first parses any partial keyword “`partial`” that may follow the sectional keyword (i.e. `coordinates partial`, `element_type partial`, or `block partial`) on its line. This indicates that the next integer value is the number of partial values defined in that section. EnSight reads the number of defined partial values, next reads this number of integer partial indices, and finally reads all corresponding partial variable values for that section. Afterwards, any variable value not specified in the list of partial indices is assigned the internal “undefined” (see previous section) value. Values interpolated between time steps must be defined for both time steps; otherwise, they are undefined.

The following `per_node` and `per_element` ASCII scalar files contain examples of partial values. For your comparison, these two files are the files `engold.Nsca` and `engold.Esca` written with some partial values specified. The same methodology applies to vector, tensor, and complex files.

### C Binary form: (Per\_node)

SCALAR FILE:

```

description line 1           80 chars
part                        80 chars
#                            1 int
coordinates partial         80 chars
nn                           1 int
i_n1 i_n2 ... i_nn          nn ints
s_n1 s_n2 ... s_nn          nn floats
part                        80 chars
.
.
part                        80 chars
#                            1 int
block partial                # nn = i*j*k    80 chars
nn                           1 int
i_n1 i_n2 ... i_nn          nn ints
s_n1 s_n2 ... s_nn          nn floats

```

### Fortran Binary form: (Per\_node)

SCALAR FILE:

```

'description line 1'        80 chars
'part'                     80 chars
'#'                         1 int
'coordinates partial'      80 chars
'nn'                       1 int
'i_n1 i_n2 ... i_nn'      nn ints
's_n1 s_n2 ... s_nn'      nn floats
'part'                     80 chars
.

```

## 11.1 EnSight Gold Partial Variable Values Format

.		
'part'		80 chars
'#'		1 int
'block partial'	# nn = i*j*k	80 chars
'nn'		1 int
'i_n1 i_n2 ... i_nn'		nn ints
's_n1 s_n2 ... s_nn'		nn floats

### ASCII form: (Per\_node)

#### SCALAR FILE:

description line 1		A (max of 79 typ)
part		A
#		I10
coordinates partial		A
nn		I10
i_n1		I10 1/line (nn)
i_n2		
.		
.		
i_nn		
s_n1		E12.5 1/line (nn)
s_n2		
.		
.		
s_nn		
part		A
.		
.		
part		A
#		I10
block partial	# nn = i*j*k	A
nn		I10
i_n1		I10 1/line (nn)
i_n2		
.		
.		
i_nn		
s_n1		E12.5 1/line (nn)
s_n2		
.		
.		
s_nn		

Partial per\_node (Scalar) Variable Example: This example shows partial data in an ASCII scalar file (engold.Nsca\_p) for the gold geometry example.

```
Per_node partial scalar values for the EnSight Gold geometry example
part
    1
coordinates partial
    9
    2
    3
    4
    5
    6
    7
    8
```

```

          9
         10
3.00000E+00
4.00000E+00
5.00000E+00
6.00000E+00
7.00000E+00
8.00000E+00
9.00000E+00
1.00000E+01
1.10000E+01
part
          2
coordinates
 1.00000E+00
 2.00000E+00
part
          3
block
 1.00000E+00
 2.00000E+00
 3.00000E+00
 4.00000E+00
 5.00000E+00
 6.00000E+00
 7.00000E+00
 8.00000E+00
 9.00000E+00
1.00000E+01
1.10000E+01
1.20000E+01

```

### C Binary form: (Per\_element)

#### SCALAR FILE:

description line 1		80 chars
part		80 chars
#		1 int
element type partial		80 chars
ne		1 int
i_n1 i_n2 ... i_ne		ne ints
s_e1 s_e2 ... s_ne		ne floats
element type partial		80 chars
ne		1 int
i_n1 i_n2 ... i_ne		ne ints
.		
.		
part		80 chars
.		
.		
part		80 chars
#		1 int
block partial	# me= (i-1)*(j-1)*(k-1)	80 chars
me		1 int
i_n1 i_n2 ... i_me		me ints
s_n1 s_n2 ... s_me		me floats

**Fortran Binary form: (Per\_element)**

## SCALAR FILE:

'description line 1'	80 chars
'part'	80 chars
'#'	1 int
'element type partial'	80 chars
'ne'	1 int
'i_n1 i_n2 ... i_ne'	ne ints
's_e1 s_e2 ... s_ne'	ne floats
'element type partial'	80 chars
'ne'	1 int
'i_n1 i_n2 ... i_ne'	ne ints
.	
.	
'part'	80 chars
.	
.	
'part'	80 chars
'#'	1 int
'block partial'	# me = (i-1)*(j-1)*(k-1) 80 chars
'me'	1 int
'i_n1 i_n2 ... i_me'	me ints
's_n1 s_n2 ... s_me'	me floats

**ASCII form: (Per\_element)**

## SCALAR FILE:

description line 1	A (max of 80 typ)
part	A
#	I10
element type partial	A
ne	I10
i_n1	I10 1/line (ne)
i_n2	
.	
.	
i_ne	
s_e1	E12.5 1/line (ne)
s_e2	
.	
.	
s_ne	
element type partial	A
ne	I10
i_n1	I10 1/line (ne)
i_n2	
.	
.	
i_ne	
.	
.	
part	A
.	
.	
part	A

```

#
block partial          # me = (i-1)*(j-1)*(k-1)
me                    I10
i_n1                  I10 1/line (me)
i_n2
.
.
i_me
s_n1                  E12.5 1/line (me)
s_n2
.
.
s_me

```

Partial per\_element (Scalar) Variable Example: This example shows partial data in an ASCII scalar file (engold.Esca\_p) for the gold geometry example.

```

Per_elem partial scalar values for the EnSight Gold geometry example
part
    1
tria3 partial
    1
    1
    2.00000E+00
hexa8
    4.00000E+00
part
    2
bar2
    1.00000E+00
part
    3
block partial
    1
    2
    6.00000E+00

```

## EnSight Gold Measured/Particle File Format

The format of a Measured/Particle geometry file is as follows:

- Line 1  
This line is a description line.
- Line 2  
Indicates that this file contains particle coordinates. The words “particle coordinates” should be entered on this line without the quotes.
- Line 3  
Specifies the number of Particles.
- Line 4 through the end of the file.  
Each line contains the ID and the X, Y, and Z coordinates of each Particle. The format of this line is “integer real real real” written out in the following format:

From C:                    %8d%12.5e%12.5e%12.5e format

From FORTRAN:    i8, 3e12.5 format

A generic measured/Particle geometry file is as follows:

```
A description line
particle coordinates
#_of_Particles
id xcoord ycoord zcoord
id xcoord ycoord zcoord
id xcoord ycoord zcoord
.
.
.
```

### *Measured Geometry Example*

The following illustrates a measured/Particle file with seven points:

```
This is a simple measured geometry file
particle coordinates
7
101 0.00000E+00 0.00000E+00 0.00000E+00
102 1.00000E+00 0.00000E+00 0.00000E+00
103 1.00000E+00 1.00000E+00 0.00000E+00
104 0.00000E+00 1.00000E+00 0.00000E+00
205 5.00000E-01 0.00000E+00 2.00000E+00
206 5.00000E-01 1.00000E+00 2.00000E+00
307 0.00000E+00 0.00000E+00-1.50000E+00
```

### *Measured Variable Files*

Measured variable files are the same as **EnSight6 case** per\_node variable files. *Please note that they are NOT the same as the EnSight gold per\_node variable files. (see EnSight6 Per\_Node Variable File Format, in Section 11.2)*

## *EnSight Gold Material Files Format*

This section contains descriptions of the three EnSight Gold material files; i.e. material id file, mixed-material id file, and mixed-material values file. A simple example dataset is also appended for quick reference.

All three EnSight Gold material files correlate to and follow the same syntax of the other EnSight Gold file formats.

### *Material Id File*

The material id file follows the same syntax as the per\_element variable files, except that its values are integers for each element of designated types of designated parts. First comes a single description line. Second comes a Part line. Third comes a line containing the part number. Fourth comes an element type line (***Note, this is the only material file that has an element type line***). And then comes the corresponding integer value for each element of that type and part (and so on for each part).

The integer value is either positive or negative. A positive integer is the material number/id for the entire element. A negative integer indicates that this element is composed of multiple, or mixed, materials. The absolute value of this negative number is a relative (1-bias) index into the mixed ids file that points to the mixed material data for each element under its part (see example below).

### *Mixed (Material) Ids File*

The mixed-material id file also contains integer values, and follows EnSight Gold syntax with exceptions as noted below. First comes a single description line. Second comes a Part line. Third comes a line containing the part number. Fourth comes a “mixed ids” keyword line. Fifth comes the size of the total mixed id array for all the mixed elements of this part. Next comes the mixed id element data for each of the elements with mixed materials for this part (and so on for each part).

The mixed id data for each of the “mixed elements” has the following order of syntax. First comes the number of mixed materials. Second comes a list of material ids that comprise that element. Next comes a negative number whose absolute value is a relative (1-bias) index into the mixed values file that points to the group of mixed-material fraction values that correspond to each listed material of that element under its part (see example below).

### *Mixed (Material) Values File*

The mixed-material values file contains float values, and also follows EnSight Gold syntax with exceptions as noted below. First comes a single description line. Second comes a Part line. Third comes a line containing the part number. Fourth comes a “mixed values” keyword line. Fifth comes the size of the total mixed values array for all the mixed elements of this part. Next comes the mixed material fraction values whose order corresponds to the order of the material ids listed for that element in the mixed ids file.

**C Binary form:**

## MATERIAL ID FILE:

description line 1	80 chars
part	80 chars
#	1 int
element type	80 chars
matid_e1 matid_e2 ... matid_ne	ne ints
element type	80 chars
.	
.	
part	80 chars
.	
.	
part	80 chars
#	1 int
block # nbe = (i-1)*(j-1)*(k-1)	80 chars
matid_e1 matid_e2 ... matid_nbe	nbe ints

## MIXED IDS FILE:

description line 1	80 chars
part	80 chars
#	1 int
mixed ids	80 chars
ni	1 int
mixid_1 mixid_2 ... mixid_ni	ni ints
.	
.	
part	80 chars
.	
.	
part	80 chars
#	1 int
mixed ids	80 chars
ni	1 int
mixid_1 mixid_2 ... mixid_ni	ni ints

## MIXED VALUES FILE:

description line 1	80 chars
part	80 chars
#	1 int
mixed values	80 chars
nf	1 int
mixval_1 mixval_2 ... mixval_nf	nf floats
.	
.	
part	80 chars
.	
.	
part	80 chars
#	1 int
mixed values	80 chars
nf	1 int
mixval_1 mixval_2 ... mixval_nf	nf floats



**Fortran Binary form:**

## MATERIAL ID FILE:

'description line 1'	80 chars
'part'	80 chars
'#'	1 int
'element type'	80 chars
'matid_e1 matid_e2 ... matid_ne'	ne ints
'element type'	80 chars
.	
.	
'part'	80 chars
.	
.	
'part'	80 chars
'#'	1 int
'block' # nbe = (i-1)*(j-1)*(k-1)	80 chars
'matid_e1 matid_e2 ... matid_nbe'	nbe ints

## MIXED IDS FILE:

'description line 1'	80 chars
'part'	80 chars
'#'	1 int
'mixed ids'	80 chars
'ni'	1 int
'mixid_1 mixid_2 ... mixid_ni'	ni ints
.	
.	
'part'	80 chars
.	
.	
'part'	80 chars
'#'	1 int
'mixed ids'	80 chars
'ni'	1 int
'mixid_1 mixid_2 ... mixid_ni'	ni ints

## MIXED VALUES FILE:

'description line 1'	80 chars
'part'	80 chars
'#'	1 int
'mixed values'	80 chars
'nf'	1 int
'mixval_1 mixval_2 ... mixval_nf'	nf floats
.	
.	
'part'	80 chars
.	
.	
'part'	80 chars
'#'	1 int
'mixed values'	80 chars
'nf'	1 int
'mixval_1 mixval_2 ... mixval_nf'	nf floats

**ASCII form:**

**MATERIAL ID FILE:**

description line 1	A (max of 79 typ)
part	A
#	I10
element type	A
matid_e1	I10 1/line (ne)
matid_e2	
...	
matid_ne	
element type	A
.	
.	
part	A
.	
.	
part	A
#	I10
block # nbe = (i-1)*(j-1)*(k-1)	A
matid_e1	I10 1/line (nbe)
matid_e2	
...	
matid_nbe	

**MIXED IDS FILE:**

description line 1	A (max of 79 typ)
part	A
#	I10
mixed ids	A
ni	I10
mixid_1	I10 1/line (ni)
mixid_2	
...	
mixid_ni . .	
part	A
.	
.	
part	A
#	I10
mixed ids	A
ni	I10
mixid_1	I10 1/line (ni)
mixid_2	
...	
mixid_ni	

**MIXED VALUES FILE:**

description line 1	A (max of 80 typ)
part	A
#	I10
mixed values	A
nf	I10
mixval_1	E12.5 1/line (nf)
mixval_2	
...	
mixval_nf	
.	
.	
part	A
.	
.	
part	A
#	I10
mixed values	A
nf	I10
mixval_1	E12.5 1/line (nf)
mixval_2	
...	
mixval_nf	

### Example Material Dataset

The following example dataset of ASCII EnSight Gold geometry and material files show the definition of material fractions for an unstructured model.

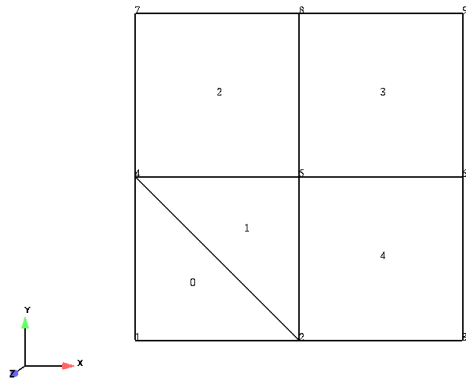
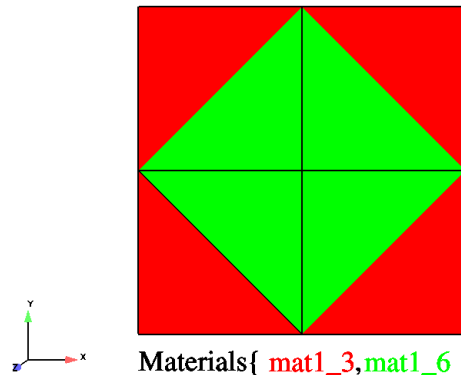

Figure 11-2  
Geometry for Example Material Dataset



Materials{ mat1\_3,mat1\_6 }  
Figure 11-2  
Materials for Example Material Dataset

### Case file

```
# Sample Case File for 2D Material Dataset
# Created: 03Apr03:mel
#
FORMAT
type: ensight gold

GEOMETRY
model:          zmat2d.geo

VARIABLE
scalar per node:  scalar zmat2d.sca

MATERIAL
material set number: 1 Mat1
material id count: 2
material id numbers: 3 6
material id names: mat1_3 mat1_6
material id per element: zmat2d.mat1
material mixed ids: zmat2d.mixi
material mixed values: zmat2d.mixv

#
#      y
#      ^
#      | Case Material ids = {3,6}
#      |
# 6.   7-----8-----9
#      |
#      | e2      e3
#      |  \      /
#      |   q0    q2
#      |  /      \
#      | /        \
#      |/.5,.5/.5/.5/
#      |
# 3.   4-----5-----6
#      |
#      | {0.,1.}
#      | t1
#      | e0 e1   e4
#      | t0   q3
#      | /     \
#      |/.5,.5/
#      |
# 0.   1-----2-----3 -> x
#      |
#      | 0.      3.      6.
#      |
#
```



```
Material Number/Id File
part
    1
tria3
    3
    6
quad4
   -1
   -5
   -9
```

Material Number/ID File  
(zmat2d.mati)

```
Mixed Ids File
part
    1
mixed ids
   12
   -2
    3
    6
   -1
    2
    3
    6
   -3
    2
    3
    6
   -5
```

Mixed Material Ids File  
(zmat2d.mixi)

Mixed Material Values File  
(zmat2d.mixv)

```
Mixed Values File
part
    1
mixed values
    6
0.50000e+00
0.50000e+00
0.50000e+00
0.50000e+00
0.50000e+00
```

Scalar File (zmat2d.sca)

```
Scalar File
part
    1
coordinates
0.00000e+00
1.00000e+00
2.00000e+00
1.00000e+00
2.00000e+00
3.00000e+00
2.00000e+00
3.00000e+00
4.00000e+00
```



## 11.2 EnSight6 Casefile Format

Included in this section:

[EnSight6 General Description](#)

[EnSight6 Geometry File Format](#)

[EnSight6 Case File Format](#)

[EnSight6 Wild Card Name Specification](#)

[EnSight6 Variable File Format](#)

[EnSight6 Per\\_Node Variable File Format](#)

[EnSight6 Per\\_Element Variable File Format](#)

[EnSight6 Measured/Particle File Format](#)

[Writing EnSight6 Binary Files](#)

### EnSight6 General Description

EnSight6 data consists of the following files:

- Case (required) (points to all other needed files including model geometry, variables, and possibly measured geometry and variables)

EnSight6 supports constant result values as well as scalar, vector, 2nd order symmetric tensor, and complex variable fields.

EnSight makes no assumptions regarding the physical significance of the variable values in the files. These files can be from any discipline. For example, the scalar file can include such things as pressure, temperature, and stress. The vector file can be velocity, displacement, or any other vector data. And so on.

All variable results for EnSight6 are contained in disk files—one variable per file. Additionally, if there are multiple time steps, there must either be a set of disk files for each time step (transient multiple-file format), or all time steps of a particular variable or geometry in one disk file (transient single-file format). Thus, all EnSight6 transient geometry and variable files can be expressed in either multiple file format or single file format.

Sources of EnSight6 data include the following:

- Data that can be translated to conform to the EnSight6 data format
- Data that originates from one of the translators supplied with the EnSight application

The EnSight6 format supports an unstructured defined element set as shown in the figure on the following page. Unstructured data must be defined in this element set. Elements that do not conform to this set must either be subdivided or discarded. The EnSight6 format also supports a structured block data format which is very similar to the PLOT3D format. *For the structured format, the standard order of nodes is such that I's advance quickest, followed by J's, and then K's.* A given EnSight6 model may have either unstructured data, structured data, or a mixture of both.

### *ens\_checker*

A program is supplied with EnSight which attempts to verify the integrity of the *format* of EnSight 6 and EnSight Gold files. If you are producing EnSight formatted data, this program can be very helpful, especially in your development stage, in making sure that you are adhering to the published format. It makes no attempt to verify the validity of floating point values, such as coordinates, variable values, etc. This program takes a casefile as input. Thus, it will check the format of the casefile, and all associated geometry and variable files referenced in the casefile. See [How To Use ens\\_checker](#).



Supported EnSight Elements

The elements that are supported by the EnSight6 format are:

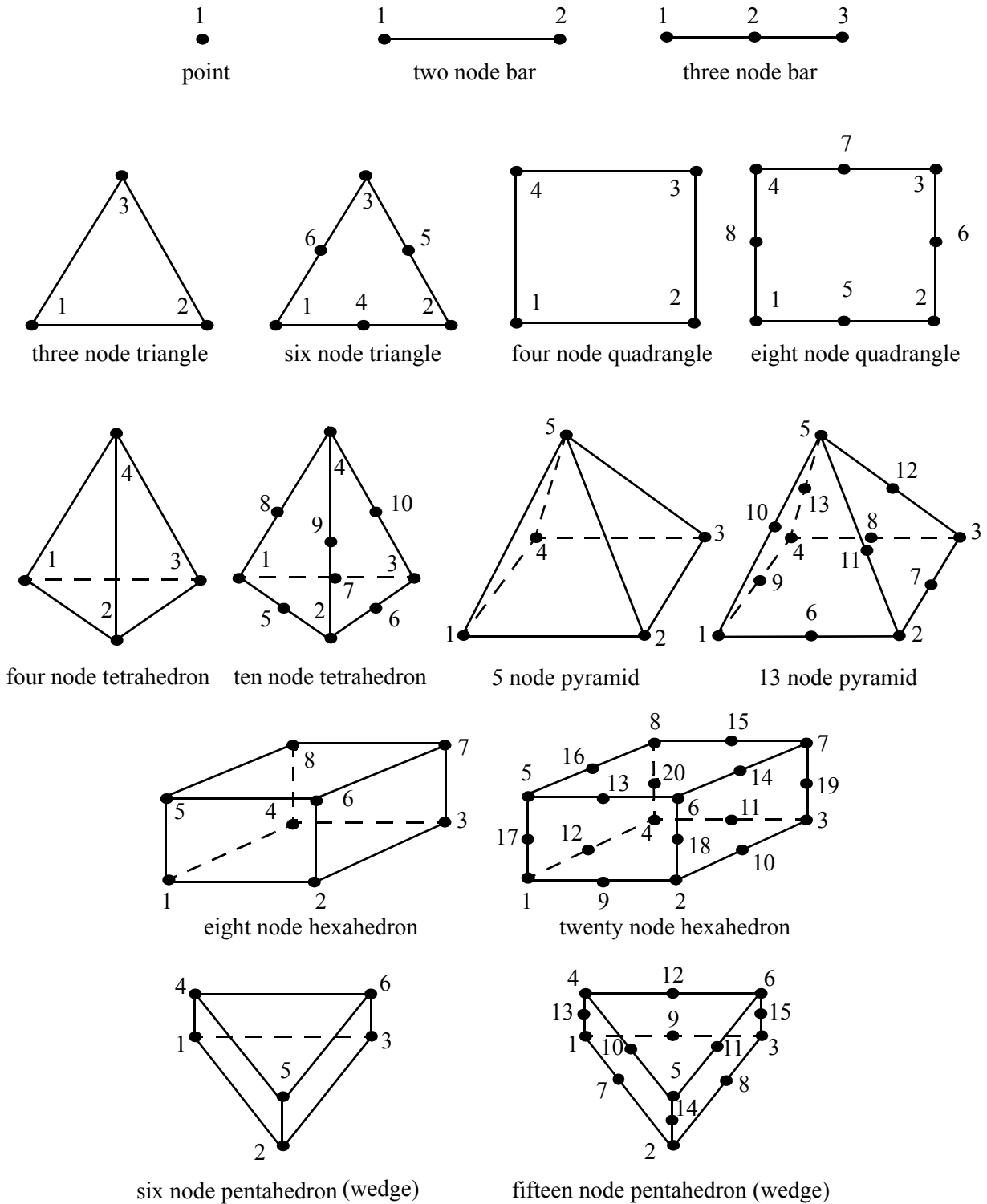

Figure 11-3  
Supported EnSight6 Elements

## EnSight6 Geometry File Format

The EnSight6 format consists of keywords followed by information. The following seven items are important when working with EnSight6 geometry files:

1. You do not have to assign node IDs. If you do, the element connectivities are based on the node numbers. If you let EnSight assign the node IDs, the nodes are considered to be sequential starting at node 1, and element connectivity is done accordingly. If node IDs are set to off, they are numbered internally; however, you will not be able to display or query on them. If you have node IDs in your data, you can have EnSight ignore them by specifying “node id ignore.” Using this option may reduce some of the memory taken up by the Client and Server, but display and query on the nodes will not be available.
2. You do not need to specify element IDs. If you specify element IDs, or you let EnSight assign them, you can show them on the screen. If they are set to off, you will not be able to show or query on them. If you have element IDs in your data you can have EnSight ignore them by specifying “element id ignore.” Using this option will reduce some of the memory taken up by the Client and Server. This may or may not be a significant amount, and remember that display and query on the elements will not be available.
3. The format of integers and real numbers **must be followed** (See the Geometry Example below).

4. Integers are written out using the following integer format:

From C:	8d format
From FORTRAN:	i8 format

Real numbers are written out using the following floating-point format:

From C:	12.5e format
From FORTRAN:	e12.5 format

**The number of integers or reals per line must also be followed!**

5. By default, a Part is processed to show the outside boundaries. This representation is loaded to the Client host system when the geometry file is read (unless other attributes have been set on the workstation, such as feature angle).
6. Coordinates for unstructured data must be defined before any Parts can be defined. The different elements can be defined in any order (that is, you can define a hexa8 before a bar2).
7. A Part containing structured data cannot contain any unstructured element types or more than one block. **Each structured Part is limited to a single block.** A structured block is indicated by following the Part description line with either the “block” line or the “block iblanked” line. An “iblanked” block must contain an additional integer array of values at each node, traditionally called the iblank array. Valid iblank values for the EnSight format are:
  - 0 for nodes which are exterior to the model, sometimes called blanked-out nodes
  - 1 for nodes which are interior to the model, thus in the free stream and to be used
  - <0 or >1 for any kind of boundary nodes

In EnSight’s structured Part building dialog, the iblank option selected will control which portion of the structured block is “created”. Thus, from the same structured block, the interior flow field part as well as a symmetry boundary part could be “created”.

*Note: By default EnSight does not do any “partial” cell iblank processing. Namely, only complete cells containing no “exterior” nodes are created. It is possible to obtain partial cell processing by issuing the “test:partial\_cells\_on” command in the Command Dialog before reading the file.*

*Note also that for the structured format, the standard order of nodes is such that I’s advance quickest, followed by J’s, and then K’s.*

### Generic Format

Not all of the lines included in the following generic example file are necessary:

```

description line 1           |
description line 2         |
node id <off/given/assign/ignore> | All geometry files must
element id <off/given/assign/ignore> | contain these first six lines
coordinates                 |
# of unstructured nodes     |
id x y z                   |
id x y z                   |
id x y z                   |
.                           |
.                           |
.                           |
part #                     |
description line           |
point                      |
number of points           |
id nd                      |
id nd                      |
id nd                      |
.                           |
.                           |
.                           |
bar2                       |
number of bar2's          |
id nd nd                  |
id nd nd                  |
id nd nd                  |
.                           |
.                           |
.                           |
bar3                       |
number of bar3's          |
id nd nd nd              |
id nd nd nd              |
id nd nd nd              |
.                           |
.                           |
.                           |
tria3                     |
number of three node triangles |
id nd nd nd              |
id nd nd nd              |
id nd nd nd              |
.                           |
.                           |
.                           |

```

## 11.2 EnSight6 Geometry File Format

```
tria6
number of six node triangles
id nd nd nd nd nd nd
.
.
.
quad4
number of quad 4's
id nd nd nd nd
id nd nd nd nd
id nd nd nd nd
id nd nd nd nd
.
.
.
quad8
number of quad 8's
id nd nd nd nd nd nd nd nd
id nd nd nd nd nd nd nd nd
id nd nd nd nd nd nd nd nd
id nd nd nd nd nd nd nd nd
.
.
.
tetra4
number of 4 node tetrahedrons
id nd nd nd nd
id nd nd nd nd
id nd nd nd nd
id nd nd nd nd
.
.
.
tetra10
number of 10 node tetrahedrons
id nd nd nd nd nd nd nd nd nd nd
id nd nd nd nd nd nd nd nd nd nd
id nd nd nd nd nd nd nd nd nd nd
id nd nd nd nd nd nd nd nd nd nd
.
.
.
pyramid5
number of 5 node pyramids
id nd nd nd nd nd
id nd nd nd nd nd
id nd nd nd nd nd
id nd nd nd nd nd
.
.
.
pyramid13
number of 13 node pyramids
id nd nd nd nd nd nd nd nd nd nd nd nd
id nd nd nd nd nd nd nd nd nd nd nd nd
id nd nd nd nd nd nd nd nd nd nd nd nd
id nd nd nd nd nd nd nd nd nd nd nd nd
.
.
.
```

```

hexa8
number of 8 node hexahedrons
id nd nd nd nd nd nd nd nd
id nd nd nd nd nd nd nd nd
id nd nd nd nd nd nd nd nd
id nd nd nd nd nd nd nd nd
.
.
.
hexa20
number of 20 node hexahedrons
id nd nd nd nd nd nd nd nd nd nd nd nd nd nd nd nd nd nd nd nd
id nd nd nd nd nd nd nd nd nd nd nd nd nd nd nd nd nd nd nd nd
id nd nd nd nd nd nd nd nd nd nd nd nd nd nd nd nd nd nd nd nd
id nd nd nd nd nd nd nd nd nd nd nd nd nd nd nd nd nd nd nd nd
id nd nd nd nd nd nd nd nd nd nd nd nd nd nd nd nd nd nd nd nd
.
.
.
penta6
number of 6 node pentahedrons
id nd nd nd nd nd nd
id nd nd nd nd nd nd
id nd nd nd nd nd nd
id nd nd nd nd nd nd
id nd nd nd nd nd nd
id nd nd nd nd nd nd
.
.
.
penta15
number of 15 node pentahedrons
id nd nd nd nd nd nd nd nd nd nd nd nd nd nd nd nd
id nd nd nd nd nd nd nd nd nd nd nd nd nd nd nd nd
id nd nd nd nd nd nd nd nd nd nd nd nd nd nd nd nd
id nd nd nd nd nd nd nd nd nd nd nd nd nd nd nd nd
id nd nd nd nd nd nd nd nd nd nd nd nd nd nd nd nd
.
.
.
part #
description line
block                               #nn=i*j*k
      i           j           k
x_n1 x_n2 x_n3 ..... x_nn          (6/line)
y_n1 y_n2 y_n3 ..... y_nn          "
z_n1 z_n2 z_n3 ..... z_nn          "

part #
description line
block      iblanked                #nn=i*j*k
      i           j           k
x_n1 x_n2 x_n3 ..... x_nn          (6/line)
y_n1 y_n2 y_n3 ..... y_nn          "
z_n1 z_n2 z_n3 ..... z_nn          "
ib_n1 ib_n2 ib_n3 ..... ib_nn      (10/line)

```

### Structured Part

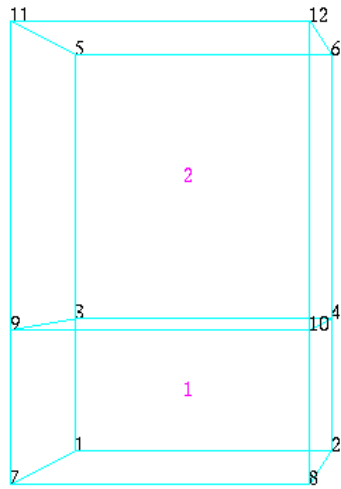

part 3

### Unstructured Parts

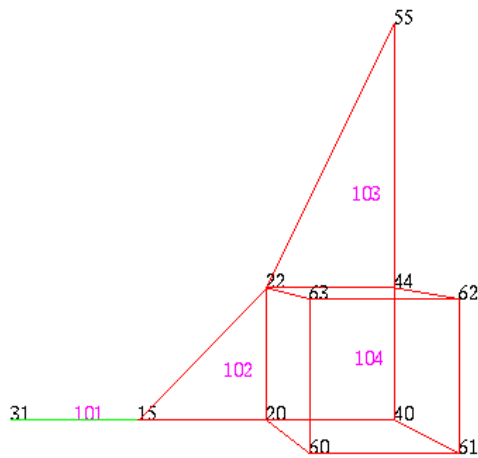

part 1 part 2

**EnSight6 Geometry File Example**

The following is an example of an ASCII EnSight6 geometry file with 11 defined unstructured nodes from which 2 unstructured parts are defined, and a 2x3x2 structured part as depicted in the above diagram. (See Case File Example 1 for reference to this file.)

```

This is the 1st description line of the EnSight6 geometry example
This is the 2nd description line of the EnSight6 geometry example
node id given
element id given
coordinates
  11
  15 4.00000e+00 0.00000e+00 0.00000e+00
  31 3.00000e+00 0.00000e+00 0.00000e+00
  20 5.00000e+00 0.00000e+00 0.00000e+00
  40 6.00000e+00 0.00000e+00 0.00000e+00
  22 5.00000e+00 1.00000e+00 0.00000e+00
  44 6.00000e+00 1.00000e+00 0.00000e+00
  55 6.00000e+00 3.00000e+00 0.00000e+00
  60 5.00000e+00 0.00000e+00 2.00000e+00
  61 6.00000e+00 0.00000e+00 2.00000e+00
  62 6.00000e+00 1.00000e+00 2.00000e+00
  63 5.00000e+00 1.00000e+00 2.00000e+00
part 1
2D uns-elements (description line for part 1)
tria3
  2
  102 15 20 22
  103 22 44 55
hexa8
  1
  104 20 40 44 22 60 61 62 63
part 2
1D uns-elements (description line for part 2)
bar2
  1
  101 31 15
part 3

```

```

3D struct-part (description line for part 3)
block iblanked
      2      3      2
0.00000e+00 2.00000e+00 0.00000e+00 2.00000e+00 0.00000e+00 2.00000e+00
0.00000e+00 2.00000e+00 0.00000e+00 2.00000e+00 0.00000e+00 2.00000e+00
0.00000e+00 0.00000e+00 1.00000e+00 1.00000e+00 3.00000e+00 3.00000e+00
0.00000e+00 0.00000e+00 1.00000e+00 1.00000e+00 3.00000e+00 3.00000e+00
0.00000e+00 0.00000e+00 0.00000e+00 0.00000e+00 0.00000e+00 0.00000e+00
2.00000e+00 2.00000e+00 2.00000e+00 2.00000e+00 2.00000e+00 2.00000e+00
      1      1      1      1      1      1      1      1      1
      1      1

```

## EnSight6 Case File Format

The Case file is an ASCII free format file that contains all the file and name information for accessing model (and measured) geometry, variable, and time information. It is comprised of five sections (`FORMAT`, `GEOMETRY`, `VARIABLE`, `TIME`, `FILE`) as described below:

*Notes:* All lines in the Case file are limited to 79 characters.

The titles of each section must be in all capital letters.

Anything preceded by a “#” denotes a comment and is ignored. Comments may append information lines or be placed on their own lines.

Information following “:” may be separated by white spaces or tabs.

Specifications encased in “[ ]” are optional, as indicated.

### Format Section

This is a required section which specifies the type of data to be read.

Usage:

```

FORMAT
type:      ensight

```

### Geometry Section

This is a required section which specifies the geometry information for the model (as well as measured geometry if present, and periodic match file (see [Section 11.9, Periodic Matchfile Format](#)) if present).

Usage:

```

GEOMETRY
model:      [ts] [fs]      filename      [change_coords_only]
measured:   [ts] [fs]      filename      [change_coords_only]
match:      filename
boundary:   filename

```

where: `ts` = time set number as specified in `TIME` section. This is optional.

`fs` = corresponding file set number as specified in `FILE` section below.

`filename` = The filename of the appropriate file.

-> Model or measured filenames for a static geometry case, as well as match and boundary filenames will not contain “\*” wildcards.

-> Model or measured filenames for a changing geometry case will contain “\*” wildcards.

`change_coords_only` = The option to indicate that the changing geometry (as indicated by wildcards in the filename) is coords only. Otherwise, changing geometry connectivity will be assumed.

*Variable Section*

This is an optional section which specifies the files and names of the variables. Constant variable values can also be set in this section.

**Usage:**

```
VARIABLE
constant per case:           [ts]           description  const_value(s)
scalar per node:            [ts] [fs]      description  filename
vector per node:           [ts] [fs]      description  filename
tensor symm per node:      [ts] [fs]      description  filename
scalar per element:        [ts] [fs]      description  filename
vector per element:        [ts] [fs]      description  filename
tensor symm per element:   [ts] [fs]      description  filename
scalar per measured node:  [ts] [fs]      description  filename
vector per measured node:  [ts] [fs]      description  filename
complex scalar per node:   [ts] [fs]      description  Re_fn    Im_fn    freq
complex vector per node:   [ts] [fs]      description  Re_fn    Im_fn    freq

complex scalar per element: [ts] [fs]      description  Re_fn    Im_fn    freq
complex vector per element: [ts] [fs]      description  Re_fn    Im_fn    freq
```

where:

ts = The corresponding time set number (or index) as specified in TIME section below. This is only required for transient constants and variables.

fs = The corresponding file set number (or index) as specified in FILE section below.

description = The variable (GUI) name (ex. Pressure, Velocity, etc.)

const\_value(s) = The constant value. If constants change over time, then ns (see TIME section below) constant values of ts.

filename = The filename of the variable file. Note: only transient filenames contain "\*" wildcards.

Re\_fn = The filename for the file containing the real values of the complex variable.

Im\_fn = The filename for the file containing the imaginary values of the complex variable.

freq = The corresponding harmonic frequency of the complex variable. For complex variables where harmonic frequency is undefined, simply use the text string: UNDEFINED.

*Note:* As many variable description lines as needed may be used.

*Note:* Variable descriptions have the following restrictions:

*The variable description is limited to 19 characters in the current release.*

*Duplicate variable descriptions are not allowed.*

*Leading and trailing white space will be eliminated.*

*Variable descriptions must not start with a numeric digit.*

*Variable descriptions must not contain any of the following reserved characters:*

```
( [ + @ ! * $
) ] - space # ^ /
```

*Time Section*

This is an optional section for steady state cases, but is required for transient cases. It contains time set information. Shown below is information for one time set. Multiple time sets (up to 16) may be specified for measured data as shown in Case File Example 3 below.

**Usage:**

```
TIME
```



```

time set:          ts [description]
number of steps:  ns
filename start number: fs
filename increment: fi
time values:      time_1 time_2 .... time_ns

```

or

```

TIME
time set:          ts [description]
number of steps:  ns
filename numbers:  fn
time values:      time_1 time_2 .... time_ns

```

where: *ts* = timeset number. This is the number referenced in the GEOMETRY and VARIABLE sections.

*description* = optional timeset description which will be shown in user interface.

*ns* = number of transient steps

*fs* = the number to replace the "\*" wildcards in the filenames, for the first step

*fi* = the increment to *fs* for subsequent steps

*time* = the actual time values for each step, each of which must be separated by a white space and which may continue on the next line if needed

*fn* = a list of numbers or indices, to replace the "\*" wildcards in the filenames.

#### File Section

This section is optional for expressing a transient case with single-file formats. This section contains single-file set information. This information specifies the number of time steps in each file of each *data entity*, i.e. each geometry and each variable (model and/or measured). Each data entity's corresponding file set might have multiple *continuation* files due to system file size limit, i.e. ~2 GB for 32-bit and ~4 TB for 64-bit architectures. Each file set corresponds to one and only one time set, but a time set may be referenced by many file sets. The following information may be specified in each file set. For file sets where all of the time set data exceeds the maximum file size limit of the system, both *filename index* and *number of steps* are repeated within the file set definition for each continuation file required. Otherwise *filename index* may be omitted if there is only one file. File set information is shown in Case File Example 4 below.

#### Usage:

```

FILE
file set:          fs
filename index:    fi # Note: only used when data continues in other files
number of steps:  ns

```

where: *fs* = file set number. This is the number referenced in the GEOMETRY and VARIABLE sections above.

*ns* = number of transient steps

*fi* = file index number in the file name (replaces "\*" in the filenames)

Case File Example 1 The following is a minimal EnSight6 case file for a steady state model with some results.

*Note: this (en6.case) file, as well as all of its referenced geometry and variable files (along with a couple of command files) can be found under your installation directory (path: \$CEI\_HOME/ensight80/data/user\_manual). The EnSight6 Geometry File Example and the Variable File Examples are the contents of these files.*

```

FORMAT
type: ensight

```

```

GEOMETRY
model: en6.geo

VARIABLE
constant per case:          Cden   .8
scalar per element:        Esca   en6.Esca
scalar per node:           Nsca   en6.Nsca
vector per element:        Evec   en6.Evec
vector per node:           Nvec   en6.Nvec

tensor symm per element:   Eten   en6.Eten
tensor symm per node:     Nten   en6.Nten

complex scalar per element: Ecmp   en6.Ecmp_r en6.Ecmp_i  2.
complex scalar per node:   Ncmp   en6.Ncmp_r en6.Ncmp_i  4.

```

Case File Example 2 The following is a Case file for a transient model. The connectivity of the geometry is also changing.

```

FORMAT
type: ensight

GEOMETRY
model:          1          example2.geo**

VARIABLE
scalar per node:  1      Stress          example2.scl**
vector per node:  1      Displacement     example2.dis**

TIME
time set:          1
number of steps:   3
filename start number: 0
filename increment: 1
time values:       1.0  2.0  3.0

```

The following files would be needed for Example 2:

```

example2.geo00      example2.scl100      example2.dis00
example2.geo01      example2.scl101      example2.dis01
example2.geo02      example2.scl102      example2.dis02

```

Case File Example 3 The following is a Case file for a transient model with measured data.

*This example has pressure given per element.*

```

FORMAT
type: ensight

GEOMETRY
model:          1          example3.geo*
measured:       2          example3.mgeo**

VARIABLE
constant per case:          Gamma      1.4
constant per case:          1      Density   .9 .9 .7 .6 .6
scalar per element:         1      Pressure   example3.pre*
vector per node:           1      Velocity   example3.vel*
scalar per measured node:   2      Temperature example3.mtem**
vector per measured node:   2      Velocity   example3.mvel**

```

```

TIME
time set:                1
number of steps:        5
filename start number:  1
filename increment:     2
time values:            .1 .2 .3          # This example shows that time
                        .4 .5          # values can be on multiple lines
time set:                2
number of steps:        6
filename start number:  0
filename increment:     2
time values:            .05 .15 .25 .34 .45 .55

```

The following files would be needed for Example 3:

example3.geo1	example3.pre1	example3.vel1
example3.geo3	example3.pre3	example3.vel3
example3.geo5	example3.pre5	example3.vel5
example3.geo7	example3.pre7	example3.vel7
example3.geo9	example3.pre9	example3.vel9
example3.mgeo00	example3.mtem00	example3.mvel00
example3.mgeo02	example3.mtem02	example3.mvel02
example3.mgeo04	example3.mtem04	example3.mvel04
example3.mgeo06	example3.mtem06	example3.mvel06
example3.mgeo08	example3.mtem08	example3.mvel08
example3.mgeo10	example3.mtem10	example3.mvel10

Case File Example 4 The following is Case File Example 3 expressed in transient single-file formats.

*In this example, the transient data for the measured velocity data entity happens to be greater than the maximum file size limit. Therefore, the first four time steps fit and are contained in the first file, and the last two time steps are 'continued' in a second file.*

```

FORMAT
type: ensight

GEOMETRY
model:                1    example4.geo
measured:            2    example4.mgeo

VARIABLE
constant per case:          Density          .5
scalar per element:        1    1    Pressure    example4.pre
vector per node:           1    1    Velocity    example4.vel
scalar per measured node:  2    2    Temperature example4.mtem
vector per measured node:  2    3    Velocity    example4.mvel*

TIME
time set:                1    Model
number of steps:        5
time values:            .1 .2 .3 .4 .5

time set:                2    Measured
number of steps:        6

```

```

time values:          .05 .15 .25 .34 .45 .55

FILE
file set:            1
number of steps:    5

file set:            2
number of steps:    6

file set:            3
filename index:     1
number of steps:    4
filename index:     2
number of steps:    2
    
```

The following files would be needed for Example 4:

```

example4.geo      example4.pre      example4.vel
example4.mgeo    example4.mtem     example4.mvel1
                  example4.mvel2
    
```

Contents of  
Transient  
Single Files

Each file contains transient data that corresponds to the specified number of time steps. The data for each time step sequentially corresponds to the simulation time values (time values) found listed in the TIME section. In transient single-file format, the data for each time step essentially corresponds to a standard EnSight6 geometry or variable file (model or measured) as expressed in multiple file format. The data for each time step is enclosed between two *wrapper* records, i.e. preceded by a BEGIN TIME STEP record and followed by an END TIME STEP record. Time step data is not split between files. If there is not enough room to append the data from a time step to the file without exceeding the maximum file limit of a particular system, then a continuation file must be created for the time step data and any subsequent time step. Any type of user comments may be included before and/or after each transient step wrapper.

*Note 1: If transient single file format is used, EnSight expects all files of a dataset to be specified in transient single file format. Thus, even static files must be enclosed between a BEGIN TIME STEP and an END TIME STEP wrapper.*

*Note 2: For binary geometry files, the first BEGIN TIME STEP wrapper must follow the <C Binary/Fortran Binary> line. Both BEGIN TIME STEP and END TIME STEP wrappers are written according to type (1) in binary. (see Writing EnSight6 Binary Files, in Section 11.2)*

*Note 3: Efficient reading of each file (especially binary) is facilitated by appending each file with a **file index**. A file index contains appropriate information to access the file byte positions of each time step in the file. (EnSight automatically appends a file index to each file when exporting in transient single file format.) If used, the file index must follow the last END TIME STEP wrapper in each file.*

**File Index Usage:**

ASCII	Binary	Item	Description
"%20d\n"	sizeof(int)	n	Total number of data time steps in the file.
"%20d\n"	sizeof(long)	fb <sub>1</sub>	File byte loc for contents of 1 <sup>st</sup> time step*
"%20d\n"	sizeof(long)	fb <sub>2</sub>	File byte loc for contents of 2 <sup>nd</sup> time step*
...	...	...	...
"%20d\n"	sizeof(long)	fb <sub>n</sub>	File byte loc for contents of n <sup>th</sup> time step*
"%20d\n"	sizeof(int)	flag	Miscellaneous flag (= 0 for now)

ASCII	Binary	Item	Description
"%20d\n"	sizeof(long)	fb of item n	File byte loc for Item n above
"%s\n"	sizeof(char)*80	"FILE_INDEX"	File index keyword

\* Each file byte location is the first byte that follows the BEGIN TIME STEP record.

Shown below are the contents of each of the above files, using the data files from Case File Example 3 for reference (without FILE\_INDEX for simplicity).

Contents of file `example4.geo_1`:

```
BEGIN TIME STEP
Contents of file example3.geo1
END TIME STEP
BEGIN TIME STEP
Contents of file example3.geo3
END TIME STEP
BEGIN TIME STEP
Contents of file example3.geo5
END TIME STEP
BEGIN TIME STEP
Contents of file example3.geo7
END TIME STEP
BEGIN TIME STEP
Contents of file example3.geo9
END TIME STEP
```

Contents of file `example4.pre_1`:

```
BEGIN TIME STEP
Contents of file example3.pre1
END TIME STEP
BEGIN TIME STEP
Contents of file example3.pre3
END TIME STEP
BEGIN TIME STEP
Contents of file example3.pre5
END TIME STEP
BEGIN TIME STEP
Contents of file example3.pre7
END TIME STEP
BEGIN TIME STEP
Contents of file example3.pre9
END TIME STEP
```

Contents of file `example4.vel_1`:

```
BEGIN TIME STEP
Contents of file example3.vel1
END TIME STEP
BEGIN TIME STEP
Contents of file example3.vel3
END TIME STEP
BEGIN TIME STEP
Contents of file example3.vel5
END TIME STEP
BEGIN TIME STEP
Contents of file example3.vel7
END TIME STEP
BEGIN TIME STEP
Contents of file example3.vel9
END TIME STEP
```

Contents of file `example4.mgeo_1`:

```
BEGIN TIME STEP
Contents of file example3.mgeo00
END TIME STEP
BEGIN TIME STEP
Contents of file example3.mgeo02
END TIME STEP
BEGIN TIME STEP
Contents of file example3.mgeo04
END TIME STEP
BEGIN TIME STEP
Contents of file example3.mgeo06
END TIME STEP
BEGIN TIME STEP
Contents of file example3.mgeo08
END TIME STEP
BEGIN TIME STEP
Contents of file example3.mgeo10
END TIME STEP
```

Contents of file `example4.mtem_1`:

```

BEGIN TIME STEP
Contents of file example3.mtem00
END TIME STEP
BEGIN TIME STEP
Contents of file example3.mtem02
END TIME STEP
BEGIN TIME STEP
Contents of file example3.mtem04
END TIME STEP
BEGIN TIME STEP
Contents of file example3.mtem06
END TIME STEP
BEGIN TIME STEP
Contents of file example3.mtem08
END TIME STEP
BEGIN TIME STEP
Contents of file example3.mtem10
END TIME STEP
Contents of file example4.mvel1_1:
BEGIN TIME STEP
Contents of file example3.mvel100
END TIME STEP
BEGIN TIME STEP
Contents of file example3.mvel102
END TIME STEP
BEGIN TIME STEP
Contents of file example3.mvel104
END TIME STEP
BEGIN TIME STEP
Contents of file example3.mvel106
END TIME STEP
Contents of file example4.mvel2_1:
Comments can precede the beginning wrapper here.
BEGIN TIME STEP
Contents of file example3.mvel108
END TIME STEP
Comments can go between time step wrappers here.
BEGIN TIME STEP
Contents of file example3.mvel110
END TIME STEP
Comments can follow the ending time step wrapper.

```

## EnSight6 Wild Card Name Specification

For transient data, if multiple time files are involved, the file names must conform to the EnSight wild-card specification. This specification is as follows:

- File names must include numbers that are in ascending order from beginning to end.
- Numbers in the files names must be zero filled if there is more than one significant digit.
- Numbers can be anywhere in the file name.
- When the file name is specified in the EnSight result file, you must replace the numbers in the file with an asterisk(\*). The number of asterisks specified is the number of significant digits. The asterisk must occupy the same place as the numbers in the file names.

## EnSight6 Variable File Format

EnSight6 variable files can either be per\_node or per\_element. They cannot be both. However, an EnSight model can have some variables which are per\_node and other variables which are per\_element.

## EnSight6 Per\_Node Variable File Format

EnSight6 variable files for per\_node variables contain any values for each unstructured node followed by any values for each structured node.

First comes a single description line.

Second comes any unstructured node value. The number of values per node depends on the type of field. An unstructured scalar field has one, a vector field has three (order: x,y,z), a 2nd order symmetric tensor field has 6 (order: 11, 22, 33, 12, 13, 23), and a 2nd order asymmetric tensor field has 9 values per node (order: 11, 12, 13, 21, 22, 23, 31, 32, 33). An unstructured complex variable in EnSight6 consists of two scalar or vector fields (one real and one imaginary), with scalar and vector values written to their separate files respectively.

Third comes any structured data information, starting with a part # line, followed by a line containing the “block”, and then lines containing the values for each structured node which are output in the same IJK component order as the coordinates. Briefly, a structured scalar is the same as an unstructured scalar, one value per node. A structured vector is written one value per node per component, thus three sequential scalar field blocks. Likewise for a structured 2nd order symmetric tensor, written as six sequential scalar field blocks, and a 2nd order tensor, written as nine sequential scalar field blocks. The same methodology applies for a complex variable only with the real and imaginary fields written to separate structured scalar or vector files.

The values **must be written** in the following floating point format (**6 per line** as shown in the examples below):

From C:                   12.5e format

From FORTRAN:       e12.5 format

The format of a per\_node variable file is as follows:

- Line 1

This line is a description line.

- Line 2 through the end of the file contains the values at each node in the model.

A generic example for *per\_node* variables:

```
One description line for the entire file
*.*****E+** *.*****E+** *.*****E+** *.*****E+** *.*****E+** *.*****E+**
*.*****E+** *.*****E+** *.*****E+** *.*****E+** *.*****E+** *.*****E+**
*.*****E+** *.*****E+** *.*****E+** *.*****E+**
part #
block
*.*****E+** *.*****E+** *.*****E+** *.*****E+** *.*****E+** *.*****E+**
*.*****E+** *.*****E+**
*.*****E+** *.*****E+** *.*****E+** *.*****E+** *.*****E+** *.*****E+**
*.*****E+** *.*****E+**
*.*****E+** *.*****E+** *.*****E+** *.*****E+** *.*****E+** *.*****E+**
*.*****E+** *.*****E+**
```

*Note that there is a format difference between the unstructured and structured*

(block) portions of the vector and tensor data. For example a multiple component unstructured vector appears as  $x y z$  triplets, while the structured counterpart lists all  $x$  then all  $y$  and finally all  $z$ .

The following variable file examples reflect scalar, vector, tensor, and complex variable values *per node* for the previously defined EnSight6 Geometry File Example with 11 defined unstructured nodes and a 2x3x2 structured Part (Part number 3). The values are summarized in the following table.

	Node Index	Node Id	Scalar Value	Vector Values	Tensor (2nd order symm.) Values	ComplexScalar	
						Real Value	Imaginary Value
<b>Unstructured</b>							
	1	15	(1.)	(1.1, 1.2, 1.3)	(1.1, 1.2, 1.3, 1.4, 1.5, 1.6)	(1.1)	(1.2)
	2	31	(2.)	(2.1, 2.2, 2.3)	(2.1, 2.2, 2.3, 2.4, 2.5, 2.6)	(2.1)	(2.2)
	3	20	(3.)	(3.1, 3.2, 3.3)	(3.1, 3.2, 3.3, 3.4, 3.5, 3.6)	(3.1)	(3.2)
	4	40	(4.)	(4.1, 4.2, 4.3)	(4.1, 4.2, 4.3, 4.4, 4.5, 4.6)	(4.1)	(4.2)
	5	22	(5.)	(5.1, 5.2, 5.3)	(5.1, 5.2, 5.3, 5.4, 5.5, 5.6)	(5.1)	(5.2)
	6	44	(6.)	(6.1, 6.2, 6.3)	(6.1, 6.2, 6.3, 6.4, 6.5, 6.6)	(6.1)	(6.2)
	7	55	(7.)	(7.1, 7.2, 7.3)	(7.1, 7.2, 7.3, 7.4, 7.5, 7.6)	(7.1)	(7.2)
	8	60	(8.)	(8.1, 8.2, 8.3)	(8.1, 8.2, 8.3, 8.4, 8.5, 8.60)	(8.1)	(8.2)
	9	61	(9.)	(9.1, 9.2, 9.3)	(9.1, 9.2, 9.3, 9.4, 9.5, 9.6)	(9.1)	(9.2)
	10	62	(10.)	(10.1,10.2,10.3)	(10.1,10.2,10.3,10.4,10.5,10.6)	(10.1)	(10.2)
	11	63	(11.)	(11.1,11.2,11.3)	(11.1,11.2,11.3,11.4,11.5,11.6)	(11.1)	(11.2)
<b>Structured</b>							
	1	1	(1.)	(1.1, 1.2, 1.3)	(1.1, 1.2, 1.3, 1.4, 1.5, 1.6)	(1.1)	(1.2)
	2	2	(2.)	(2.1, 2.2, 2.3)	(2.1, 2.2, 2.3, 2.4, 2.5, 2.6)	(2.1)	(2.2)
	3	3	(3.)	(3.1, 3.2, 3.3)	(3.1, 3.2, 3.3, 3.4, 3.5, 3.6)	(3.1)	(3.2)
	4	4	(4.)	(4.1, 4.2, 4.3)	(4.1, 4.2, 4.3, 4.4, 4.5, 4.6)	(4.1)	(4.2)
	5	5	(5.)	(5.1, 5.2, 5.3)	(5.1, 5.2, 5.3, 5.4, 5.5, 5.6)	(5.1)	(5.2)
	6	6	(6.)	(6.1, 6.2, 6.3)	(6.1, 6.2, 6.3, 6.4, 6.5, 6.6)	(6.1)	(6.2)
	7	7	(7.)	(7.1, 7.2, 7.3)	(7.1, 7.2, 7.3, 7.4, 7.5, 7.6)	(7.1)	(7.2)
	8	8	(8.)	(8.1, 8.2, 8.3)	(8.1, 8.2, 8.3, 8.4, 8.5, 8.6)	(8.1)	(8.2)
	9	9	(9.)	(9.1, 9.2, 9.3)	(9.1, 9.2, 9.3, 9.4, 9.5, 9.6)	(9.1)	(9.2)
	10	10	(10.)	(10.1,10.2,10.3)	(10.1,10.2,10.3,10.4,10.5,10.6)	(10.1)	(10.2)
	11	11	(11.)	(11.1,11.2,11.3)	(11.1,11.2,11.3,11.4,11.5,11.6)	(11.1)	(11.2)

**Per\_node (Scalar) Variable Example 1** This example shows ASCII scalar file (`en6.Nsca`) for the geometry example.

```
Per_node scalar values for the EnSight6 geometry example
1.00000E+00 2.00000E+00 3.00000E+00 4.00000E+00 5.00000E+00 6.00000E+00
7.00000E+00 8.00000E+00 9.00000E+00 1.00000E+01 1.10000E+01
part 3
block
1.00000E+00 2.00000E+00 3.00000E+00 4.00000E+00 5.00000E+00 6.00000E+00
7.00000E+00 8.00000E+00 9.00000E+00 1.00000E+01 1.10000E+01
```

**Per\_node (Vector) Variable Example 2** This example shows ASCII vector file (`en6.Nvec`) for the geometry example.

```
Per_node vector values for the EnSight6 geometry example
1.10000E+00 1.20000E+00 1.30000E+00 2.10000E+00 2.20000E+00 2.30000E+00
3.10000E+00 3.20000E+00 3.30000E+00 4.10000E+00 4.20000E+00 4.30000E+00
5.10000E+00 5.20000E+00 5.30000E+00 6.10000E+00 6.20000E+00 6.30000E+00
7.10000E+00 7.20000E+00 7.30000E+00 8.10000E+00 8.20000E+00 8.30000E+00
9.10000E+00 9.20000E+00 9.30000E+00 1.01000E+01 1.02000E+01 1.03000E+01
1.11000E+01 1.12000E+01 1.13000E+01
part 3
```



```

block
1.10000E+00 2.10000E+00 3.10000E+00 4.10000E+00 5.10000E+00 6.10000E+00
7.10000E+00 8.10000E+00 9.10000E+00 1.01000E+01 1.11000E+01
1.20000E+00 2.20000E+00 3.20000E+00 4.20000E+00 5.20000E+00 6.20000E+00
7.20000E+00 8.20000E+00 9.20000E+00 1.02000E+01 1.12000E+01
1.30000E+00 2.30000E+00 3.30000E+00 4.30000E+00 5.30000E+00 6.30000E+00
7.30000E+00 8.30000E+00 9.30000E+00 1.03000E+01 1.13000E+01

```

**Per\_node (Tensor) Variable Example 3** This example shows an ASCII 2nd order symmetric tensor file (`en6.Nten`) for the geometry example.

```

Per_node symmetric tensor values for the EnSight6 geometry example
1.10000E+00 1.20000E+00 1.30000E+00 1.40000E+00 1.50000E+00 1.60000E+00
2.10000E+00 2.20000E+00 2.30000E+00 2.40000E+00 2.50000E+00 2.60000E+00
3.10000E+00 3.20000E+00 3.30000E+00 3.40000E+00 3.50000E+00 3.60000E+00
4.10000E+00 4.20000E+00 4.30000E+00 4.40000E+00 4.50000E+00 4.60000E+00
5.10000E+00 5.20000E+00 5.30000E+00 5.40000E+00 5.50000E+00 5.60000E+00
6.10000E+00 6.20000E+00 6.30000E+00 6.40000E+00 6.50000E+00 6.60000E+00
7.10000E+00 7.20000E+00 7.30000E+00 7.40000E+00 7.50000E+00 7.60000E+00
8.10000E+00 8.20000E+00 8.30000E+00 8.40000E+00 8.50000E+00 8.60000E+00
9.10000E+00 9.20000E+00 9.30000E+00 9.40000E+00 9.50000E+00 9.60000E+00
1.01000E+01 1.02000E+01 1.03000E+01 1.04000E+01 1.05000E+01 1.06000E+01
1.11000E+01 1.12000E+01 1.13000E+01 1.14000E+01 1.15000E+01 1.16000E+01
part 3
block
1.10000E+00 2.10000E+00 3.10000E+00 4.10000E+00 5.10000E+00 6.10000E+00
7.10000E+00 8.10000E+00 9.10000E+00 1.01000E+01 1.11000E+01
1.20000E+00 2.20000E+00 3.20000E+00 4.20000E+00 5.20000E+00 6.20000E+00
7.20000E+00 8.20000E+00 9.20000E+00 1.02000E+01 1.12000E+01
1.30000E+00 2.30000E+00 3.30000E+00 4.30000E+00 5.30000E+00 6.30000E+00
7.30000E+00 8.30000E+00 9.30000E+00 1.03000E+01 1.13000E+01
1.40000E+00 2.40000E+00 3.40000E+00 4.40000E+00 5.40000E+00 6.40000E+00
7.40000E+00 8.40000E+00 9.40000E+00 1.04000E+01 1.14000E+01
1.50000E+00 2.50000E+00 3.50000E+00 4.50000E+00 5.50000E+00 6.50000E+00
7.50000E+00 8.50000E+00 9.50000E+00 1.05000E+01 1.15000E+01
1.60000E+00 2.60000E+00 3.60000E+00 4.60000E+00 5.60000E+00 6.60000E+00
7.60000E+00 8.60000E+00 9.60000E+00 1.06000E+01 1.16000E+01

```

**Per\_node (Complex) Variable Example 4** This example shows the ASCII complex real (`en6.Ncmp_r`) and imaginary (`en6.Ncmp_i`) *scalar* files for the geometry example. (The same methodology would apply for complex real and imaginary *vector* files.)

Real scalar File:

```

Per_node complex real scalar values for the EnSight6 geometry example
1.10000E+00 2.10000E+00 3.10000E+00 4.10000E+00 5.10000E+00 6.10000E+00
7.10000E+00 8.10000E+00 9.10000E+00 1.01000E+01 1.11000E+01
part 3
block
1.10000E+00 2.10000E+00 3.10000E+00 4.10000E+00 5.10000E+00 6.10000E+00
7.10000E+00 8.10000E+00 9.10000E+00 1.01000E+01 1.11000E+01 1.21000E+00

```

Imaginary scalar File:

```

Per_node complex imaginary scalar values for the EnSight6 geometry example
1.20000E+00 2.20000E+00 3.20000E+00 4.20000E+00 5.20000E+00 6.20000E+00
7.20000E+00 8.20000E+00 9.20000E+00 1.02000E+01 1.12000E+01
part 3
block
1.20000E+00 2.20000E+00 3.20000E+00 4.20000E+00 5.20000E+00 6.20000E+00
7.20000E+00 8.20000E+00 9.20000E+00 1.02000E+01 1.12000E+01 1.22000E+00

```

## EnSight6 Per\_Element Variable File Format

EnSight variable files for `per_element` variables contain values for each element of designated types of designated Parts. First comes a single description line. Second comes a Part line. Third comes an element type line and fourth comes the value for each element of that type and part. If it is a scalar variable, there is one value per element, while for vector variables there are three values per element. (The number of elements of the given type are obtained from the corresponding EnSight6 geometry file.)

The values must be written in the following floating point format (6 per line as shown in the examples below):

From C: `12.5e` format

From FORTRAN: `e12.5` format

The format of a `per_element` variable file is as follows:

- Line 1 This line is a description line.
- Line 2 Part line, with part number corresponding to the geometry file.
- Line 3 Element type line ( example: `tria3`, `hexa8`, ... )
- Line 4 Repeats until next element type line, part line, or end of file is reached. Lists values for each element of this part and type.

A generic example for *per\_element* variables:

```
One description line for the entire file
part #
element type
*.*****E+** *.*****E+** *.*****E+** *.*****E+** *.*****E+** *.*****E+**
*.*****E+** *.*****E+**
part #
block
*.*****E+** *.*****E+** *.*****E+** *.*****E+** *.*****E+** *.*****E+**
*.*****E+** *.*****E+** *.*****E+** *.*****E+**
*.*****E+** *.*****E+** *.*****E+** *.*****E+** *.*****E+** *.*****E+**
*.*****E+** *.*****E+** *.*****E+** *.*****E+**
*.*****E+** *.*****E+** *.*****E+** *.*****E+** *.*****E+** *.*****E+**
*.*****E+** *.*****E+** *.*****E+** *.*****E+**
```

*Note that there is a format difference between the unstructured and structured (block) portions of the vector and tensor data. For example a multiple component unstructured vector appears as `x y z` triplets, while the structured counterpart lists all `x` then all `y` and finally all `z`.*

The following variable file examples reflect scalar, vector, tensor, and complex variable values *per element* for the previously defined EnSight6 Geometry File Example with 11 defined unstructured nodes and a 2x3x2 structured Part (Part number 3). The values are summarized in the following table.

	Element Index	Element Id	Scalar Value	Vector Values	Tensor (2nd order symm.) Values	Complex Scalar	
						Real Value	Imaginary Value
<b>Unstructured</b>							
bar2	1	101	(1.)	(1.1, 1.2, 1.3)	(1.1, 1.2, 1.3, 1.4, 1.5, 1.6)	(1.1)	(1.2)
tria3	1	102	(2.)	(2.1, 2.2, 2.3)	(2.1, 2.2, 2.3, 2.4, 2.5, 2.6)	(2.1)	(2.2)
	2	103	(3.)	(3.1, 3.2, 3.3)	(3.1, 3.2, 3.3, 3.4, 3.5, 3.6)	(3.1)	(3.2)
hexa8	1	104	(4.)	(4.1, 4.2, 4.3)	(4.1, 4.2, 4.3, 4.4, 4.5, 4.6)	(4.1)	(4.2)
<b>Structured</b>							
block	1	1	(5.)	(5.1, 5.2, 5.3)	(5.1, 5.2, 5.3, 5.4, 5.5, 5.6)	(5.1)	(5.2)
	2	2	(6.)	(6.1, 6.2, 6.3)	(6.1, 6.2, 6.3, 6.4, 6.5, 6.6)	(6.1)	(6.2)
	3	3	(7.)	(7.1, 7.2, 7.3)	(7.1, 7.2, 7.3, 7.4, 7.5, 7.6)	(7.1)	(7.2)
	4	4	(8.)	(8.1, 8.2, 8.3)	(8.1, 8.2, 8.3, 8.4, 8.5, 8.6)	(8.1)	(8.2)
	5	5	(9.)	(9.1, 9.2, 9.3)	(9.1, 9.2, 9.3, 9.4, 9.5, 9.6)	(9.1)	(9.2)
	6	6	(10.)	(10.1, 10.2, 10.3)	(10.1, 10.2, 10.3, 10.4, 10.5, 10.6)	(10.1)	(10.2)
	7	7	(11.)	(11.1, 11.2, 11.3)	(11.1, 11.2, 11.3, 11.4, 11.5, 11.6)	(11.1)	(11.2)
	8	8	(12.)	(12.1, 12.2, 12.3)	(12.1, 12.2, 12.3, 12.4, 12.5, 12.6)	(12.1)	(12.2)

**Per\_element (Scalar) Variable Example 1** This example shows an ASCII scalar file (`en6.Esca`) for the geometry example.

```
Per_elem scalar values for the EnSight6 geometry example
part 1
tria3
  2.00000E+00 3.00000E+00
hexa8
  4.00000E+00
part 2
bar2
  1.00000E+00
part 3
block
  5.00000E+00 6.00000E+00 7.00000E+00 8.00000E+00 9.00000E+00 1.00000E+01
  1.10000E+01 1.20000E+01
```

**Per\_element (Vector) Variable Example 2** This example shows an ASCII vector file (`en6.Evec`) for the geometry example.

```
Per_elem vector values for the EnSight6 geometry example
part 1
tria3
  2.10000E+00 2.20000E+00 2.30000E+00 3.10000E+00 3.20000E+00 3.30000E+00
hexa8
  4.10000E+00 4.20000E+00 4.30000E+00
part 2
bar2
  1.10000E+00 1.20000E+00 1.30000E+00
part 3
block
  5.10000E+00 6.10000E+00 7.10000E+00 8.10000E+00 9.10000E+00 1.01000E+01
  1.11000E+01 1.21000E+01
```

## 11.2 EnSight6 Per\_Element Variable File Format

```
5.20000E+00 6.20000E+00 7.20000E+00 8.20000E+00 9.20000E+00 1.02000E+01
1.12000E+01 1.22000E+01
5.30000E+00 6.30000E+00 7.30000E+00 8.30000E+00 9.30000E+00 1.03000E+01
1.13000E+01 1.23000E+01
```

**Per\_element (Tensor) Variable Example 3** This example shows the ASCII 2nd order symmetric tensor file (`en6.Eten`) for the geometry example.

```
Per_elem symmetric tensor values for the EnSight6 geometry example
part 1
tria3
 2.10000E+00 2.20000E+00 2.30000E+00 2.40000E+00 2.50000E+00 2.60000E+00
 3.10000E+00 3.20000E+00 3.30000E+00 3.40000E+00 3.50000E+00 3.60000E+00
hexa8
 4.10000E+00 4.20000E+00 4.30000E+00 4.40000E+00 4.50000E+00 4.60000E+00
part 2
bar2
 1.10000E+00 1.20000E+00 1.30000E+00 1.40000E+00 1.50000E+00 1.60000E+00
part 3
block
 5.10000E+00 6.10000E+00 7.10000E+00 8.10000E+00 9.10000E+00 1.01000E+01
 1.11000E+01 1.21000E+01
 5.20000E+00 6.20000E+00 7.20000E+00 8.20000E+00 9.20000E+00 1.02000E+01
 1.12000E+01 1.22000E+01
 5.30000E+00 6.30000E+00 7.30000E+00 8.30000E+00 9.30000E+00 1.03000E+01
 1.13000E+01 1.23000E+01
 5.40000E+00 6.40000E+00 7.40000E+00 8.40000E+00 9.40000E+00 1.04000E+01
 1.14000E+01 1.24000E+01
 5.50000E+00 6.50000E+00 7.50000E+00 8.50000E+00 9.50000E+00 1.05000E+01
 1.15000E+01 1.25000E+01
 5.60000E+00 6.60000E+00 7.60000E+00 8.60000E+00 9.60000E+00 1.06000E+01
 1.16000E+01 1.26000E+01
```

**Per\_element (Complex) Variable Example 4** This example shows the ASCII complex real (`en6.Ecmp_r`) and imaginary (`en6.Ecmp_i`) *scalar* files for the geometry example. (The same methodology would apply for complex real and imaginary *vector* files).

Real scalar File:

```
Per_elem complex real scalar values for the EnSight6 geometry example
part 1
tria3
 2.10000E+00 3.10000E+00
hexa8
 4.10000E+00
part 2
bar2
 1.10000E+00
part 3
block
 5.10000E+00 6.10000E+00 7.10000E+00 8.10000E+00 9.10000E+00 1.01000E+01
 1.11000E+01 1.21000E+01
```

Imaginary scalar File:

```
Per_elem complex imaginary scalar values for the EnSight6 geometry example
part 1
tria3
 2.20000E+00 3.20000E+00
hexa8
 4.20000E+00
part 2
bar2
 1.20000E+00
part 3
block
 5.20000E+00 6.20000E+00 7.20000E+00 8.20000E+00 9.20000E+00 1.02000E+01
 1.12000E+01 1.22000E+01
```



## EnSight6 Measured/Particle File Format

The format of a Measured/Particle geometry file is as follows:

- Line 1  
This line is a description line.
- Line 2  
Indicates that this file contains particle coordinates. The words “particle coordinates” should be entered on this line without the quotes.
- Line 3  
Specifies the number of Particles.
- Line 4 through the end of the file.  
Each line contains the ID and the X, Y, and Z coordinates of each Particle. The format of this line is “integer real real real” written out in the following format:

From C:                    %8d%12.5e%12.5e%12.5e format

From FORTRAN:    i8, 3e12.5 format

A generic measured/Particle geometry file is as follows:

```
A description line
particle coordinates
#_of_Particles
id xcoord ycoord zcoord
id xcoord ycoord zcoord
id xcoord ycoord zcoord
.
.
.
```

### *Measured Geometry Example*

The following illustrates a measured/Particle file with seven points:

```
This is a simple measured geometry file
particle coordinates
7
101 0.00000E+00 0.00000E+00 0.00000E+00
102 1.00000E+00 0.00000E+00 0.00000E+00
103 1.00000E+00 1.00000E+00 0.00000E+00
104 0.00000E+00 1.00000E+00 0.00000E+00
205 5.00000E-01 0.00000E+00 2.00000E+00
206 5.00000E-01 1.00000E+00 2.00000E+00
307 0.00000E+00 0.00000E+00-1.50000E+00
```

### *Measured Variable Files*

Measured variable files use the same format as EnSight6 per\_node variable files.

## Writing EnSight6 Binary Files

This section describes the EnSight6 binary files. This format is used to increase the speed of reading data into EnSight.

For binary files, there is a header that designates the type of binary file. This header is: “C Binary” or “Fortran Binary.” This must be the first thing in the geometry file only. The format for the file is then essentially the same format as the ASCII format, with the following exceptions:

The ASCII format puts the node and element ids on the same “line” as the corresponding coordinates. The BINARY format writes all node id’s then all coordinates.

The ASCII format puts all element id’s of a type within a Part on the same “line” as the corresponding connectivity. The BINARY format writes all the element ids for that type, then all the corresponding connectivities of the elements.

FORTRAN binary files should be created as sequential access unformatted files.

Float arrays (such as coordinates and variable values) must be single precision. Double precision is not supported.

In all the descriptions of binary files that follow, the number on the left end of the line corresponds to the type of write of that line, according to the following code:

1. This is a write of 80 characters to the file:

C example: 

```
char buffer[80];
strcpy(buffer, "C Binary");
fwrite(buffer, sizeof(char), 80, file_ptr);
```

FORTRAN: 

```
character*80 buffer
buffer = "Fortran Binary"
write(10) buffer
```

2. This is a write of a single integer:

C example: 

```
fwrite(&num_nodes, sizeof(int), 1, file_ptr);
```

FORTRAN: 

```
write(10) num_nodes
```

3. This is a write of an integer array:

C example: 

```
fwrite(node_ids, sizeof(int), num_nodes, file_ptr);
```

FORTRAN: 

```
write(10) (node_ids(i), i=1, num_nodes)
```

4. This is a write of a float array:

C example: 

```
fwrite(coords, sizeof(float), 3*num_nodes, file_ptr);
```

FORTRAN: 

```
write(10) ((coords(i,j), i=1,3), j=1, num_nodes)
```

*Note: For EnSight6 format, when using **Fortran binary**, and writing arrays composed of components, such as coordinates, or vector values, it is **very important** that they all be written with a **single Fortran write statement**. If you instead were to write the coords in the statement above with a loop per component, such that the write statement is executed three times, like the following, **EnSight will not be able to read it!***

```
FORTRAN: do 200 i=1,3
           write(10) (coords(i,j), j=1, num_nodes)
           200 continue
```

*EnSight6 Binary  
Geometry*

An EnSight binary geometry file contains information in the following order:

- (1) <C Binary/Fortran Binary>
- (1) description line 1
- (1) description line 2
- (1) node id <given/off/assign/ignore>
- (1) element id <given/off/assign/ignore>
- (1) coordinates
- (2) #\_of\_points
- (3) [point\_ids]
- (4) coordinate\_array *(For FORTRAN make sure only one write statement is used)*
- (1) part #
- (1) description line
- (1) element\_type
- (2) #\_of\_element\_type
- (3) [element\_ids] for the element\_type
- (3) connectivities for the element\_type
- (1) element\_type
- (2) #\_of\_element\_type
- (3) [element\_ids] for the element\_type
- (3) connectivities for the element\_type
- :
- (1) part #
- (1) description line
- (1) element\_type
- (2) #\_of\_element\_type
- (3) [element\_ids] for the element\_type
- (3) connectivities for the element\_type
- (1) element\_type
- (2) #\_of\_element\_type
- (3) [element\_ids] for the element\_type
- (3) connectivities for the element\_type
- (1) part #
- (1) description line
- (1) block [iblanked]
- (3) i j k
- (4) all i coords, all j coords, all k coords *(For FORTRAN make sure only one write statement is used)*
- (3) [iblanking]
- :

*Per\_node Binary Scalar* An EnSight6 binary scalar file contains information in the following order:

- (1) description line
- (4) scalar\_array for unstructured nodes
- (1) part #
- (1) block
- (4) scalar\_array for part's structured nodes

*Per\_node Binary Vector* An EnSight6 binary vector file contains information in the following order:

- (1) description line
- (4) vector\_array for unstructured nodes *(For FORTRAN make sure only one write statement is used)*



- (1) part #
- (1) block
- (4) vector\_array for part's structured nodes *(For FORTRAN make sure only one write statement is used)*

*Per\_node Binary Tensor* An EnSight6 binary tensor file contains information in the following order:

- (1) description line
- (4) tensor\_array for unstructured nodes *(For FORTRAN make sure only one write statement is used)*
- (1) part #
- (1) block
- (4) tensor\_array for part's structured nodes *(For FORTRAN make sure only one write statement is used)*

*Per\_node Binary Complex* An EnSight6 binary complex real and imaginary *scalar* files contain information in the following order: (The same methodology applies for the complex real and imaginary vector files.)

Real scalar file:

- (1) description line
- (4) real scalar\_array for unstructured nodes
- (1) part #
- (1) block
- (4) real scalar\_array for part's structured nodes

Imaginary scalar file:

- (1) description line
- (4) imaginary scalar\_array for unstructured nodes
- (1) part #
- (1) block
- (4) imaginary scalar\_array for part's structured nodes

*Per\_element Binary Scalar* An EnSight6 binary scalar file contains information in the following order:

- (1) description line
- (1) part #
- (1) element type (tria3, quad4, ...)
- (4) scalar\_array for elements of part and type
- (1) part #
- (1) block
- (4) scalar\_array for structured elements of part

*Per\_element Binary Vector* An EnSight6 binary vector file contains information in the following order:

- (1) description line
- (1) part #
- (1) element type (tria3, quad4, ...)
- (4) vector\_array for elements of part and type *(For FORTRAN make sure only one write statement is used)*
- (1) part #
- (1) block
- (4) vector\_array for structured elements of part *(For FORTRAN make sure only one write statement is used)*

*Per\_element Binary Tensor* An EnSight6 binary tensor file contains information in the following order:

- (1) description line
- (1) part #
- (1) element type (tria3, quad4, ...)
- (4) tensor\_array for unstructured elements of part and type *(For FORTRAN make sure only one write statement is used)*
- (1) part #
- (1) block
- (4) tensor\_array for structured elements of part and type *(For FORTRAN make sure only one write statement is used)*

*Per\_element Binary Complex* EnSight6 binary complex real and imaginary *scalar* files contain information in the following order: (The same methodology applies for the complex real and imaginary vector files.)

Real scalar file:

- (1) description line
- (1) part #
- (1) element type (tria3, quad4, ...)
- (4) real scalar\_array for unstructured elements of part and type
- (1) part #
- (1) block
- (4) real scalar\_array for structured elements of part and type

Imaginary scalar file:

- (1) description line
- (1) part #
- (1) element type (tria3, quad4, ...)
- (4) imaginary scalar\_array for unstructured elements of part and type
- (1) part #
- (1) block
- (4) imaginary scalar\_array for structured elements of part and type

*Binary Measured Geometry*

An EnSight6 binary measured/particle geometry file contains information in the following order:

- (1) <C Binary/Fortran Binary>
- (1) description line 1
- (1) particle coordinates
- (2) #\_of\_points
- (3) point\_ids
- (4) coordinate\_array *(For FORTRAN make sure only one write statement is used)*

*Binary Measured Variable Files*

EnSight6 binary measured/discrete particle scalar and vector files follow the same binary formats as EnSight6 model per-node scalar and vector files.

## 11.3 EnSight5 Format

Included in this section:

**EnSight5 General Description**

**EnSight5 Geometry File Format**

**EnSight5 Result File Format**

**EnSight5 Wild Card Name Specification**

**EnSight5 Variable File Format**

**EnSight5 Measured/Particle File Format**

**Writing EnSight5 Binary Files**

### EnSight5 General Description

*Note: The EnSight6 format replaces and includes all aspects of the older EnSight5 format. This description is included for completeness but use of the EnSight6 format with EnSight 6.x and later versions is encouraged!*

EnSight5 data consists of the following files:

- Geometry (required)
- Results (optional) (points to other variable files and possibly to changing geometry files)
- Measured (optional) (points to measured geometry and variable files)

The results file contains information concerning scalar and vector variables. EnSight makes no assumptions regarding the physical significance of the scalar and vector variables. These files can be from any discipline. For example, the scalar file can include such things as pressure, temperature, and stress. The vector file can be velocity, displacement, or any other vector data.

All variable results for EnSight5 are contained in disk files—one variable per file. Additionally, if there are multiple time steps, there must be a set of disk files for each time step.

Sources of EnSight5 data include the following:

- Data that can be translated to conform to the EnSight5 data format
- Data that originates from one of the translators supplied with the EnSight application

The EnSight5 format supports a defined element set as shown below. The data must be defined in this element set. Elements that do not conform to this set must either be subdivided or discarded.

### Supported EnSight5 Elements

The elements that are supported by the EnSight5 format are:

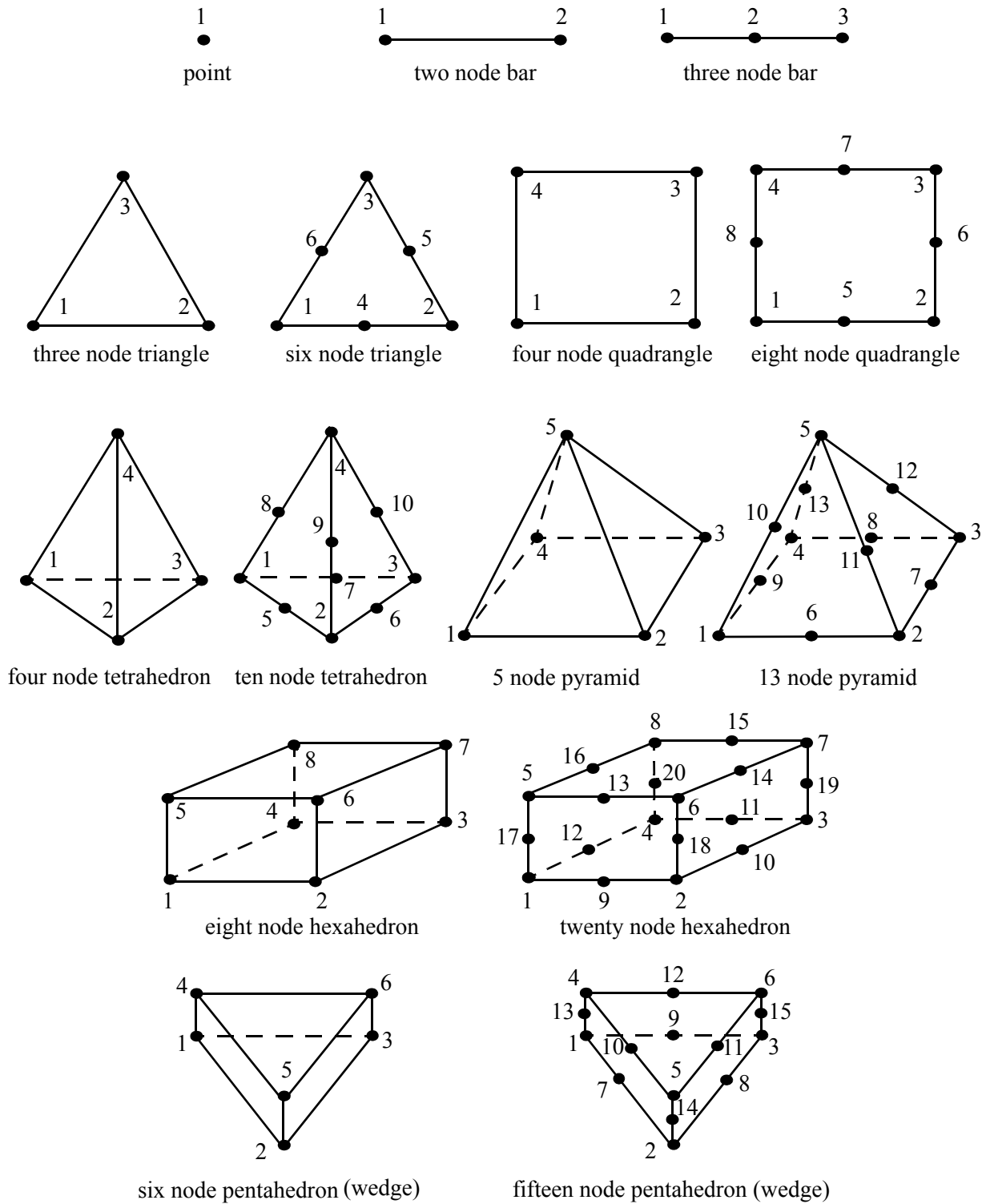

Figure 11-4  
Supported EnSight5 Elements



## 11.3 EnSight5 Geometry File Format

```
id x y z
.
.
.
part #
description line
point
number of points
id nd
id nd
id nd
.
.
.
bar2
number of bar2's
id nd nd
id nd nd
id nd nd
.
.
.
bar3
number of bar3's
id nd nd nd
id nd nd nd
id nd nd nd
.
.
.
tria3
number of three node triangles
id nd nd nd
id nd nd nd
id nd nd nd
.
.
.
tria6
number of six node triangles
id nd nd nd nd nd nd
.
.
.
quad4
number of quad 4's
id nd nd nd nd
id nd nd nd nd
id nd nd nd nd
id nd nd nd nd
.
.
.
quad8
number of quad 8's
id nd nd nd nd nd nd nd nd
id nd nd nd nd nd nd nd nd
id nd nd nd nd nd nd nd nd
id nd nd nd nd nd nd nd nd
.
.
```

```

.
tetra4
number of 4 node tetrahedrons
id nd nd nd nd
id nd nd nd nd
id nd nd nd nd
id nd nd nd nd
.
.
.
tetra10
number of 10 node tetrahedrons
id nd nd nd nd nd nd nd nd nd nd
id nd nd nd nd nd nd nd nd nd nd
id nd nd nd nd nd nd nd nd nd nd
id nd nd nd nd nd nd nd nd nd nd
.
.
.
pyramid5
number of 5 node pyramids
id nd nd nd nd nd
id nd nd nd nd nd
id nd nd nd nd nd
id nd nd nd nd nd
.
.
.
pyramid13
number of 13 node pyramids
id nd nd nd nd nd nd nd nd nd nd nd nd nd nd
id nd nd nd nd nd nd nd nd nd nd nd nd nd nd
id nd nd nd nd nd nd nd nd nd nd nd nd nd nd
id nd nd nd nd nd nd nd nd nd nd nd nd nd nd
.
.
.
hexa8
number of 8 node hexahedrons
id nd nd nd nd nd nd nd nd nd
id nd nd nd nd nd nd nd nd nd
id nd nd nd nd nd nd nd nd nd
id nd nd nd nd nd nd nd nd nd
.
.
.
hexa20
number of 20 node hexahedrons
id nd nd nd nd nd nd nd nd nd nd nd nd nd nd nd nd nd nd nd nd
id nd nd nd nd nd nd nd nd nd nd nd nd nd nd nd nd nd nd nd nd
id nd nd nd nd nd nd nd nd nd nd nd nd nd nd nd nd nd nd nd nd
id nd nd nd nd nd nd nd nd nd nd nd nd nd nd nd nd nd nd nd nd
id nd nd nd nd nd nd nd nd nd nd nd nd nd nd nd nd nd nd nd nd
.
.
.
penta6
number of 6 node pentahedrons
id nd nd nd nd nd nd
id nd nd nd nd nd nd
id nd nd nd nd nd nd

```

## 11.3 EnSight5 Geometry File Format

```
id nd nd nd nd nd nd
id nd nd nd nd nd nd
.
.
.
penta15
number of 15 node pentahedrons
id nd nd nd nd nd nd nd nd nd nd nd nd nd nd nd nd
id nd nd nd nd nd nd nd nd nd nd nd nd nd nd nd nd
id nd nd nd nd nd nd nd nd nd nd nd nd nd nd nd nd
id nd nd nd nd nd nd nd nd nd nd nd nd nd nd nd nd
id nd nd nd nd nd nd nd nd nd nd nd nd nd nd nd nd
.
.
.
```

### *EnSight5 Geometry Example*

The following is an example of an EnSight geometry file:

```
this is an example problem
this is the second description line
node id given
element id given
coordinates
  10
  5 1.00000e+00 0.00000e+00 0.00000e+00
 100 0.00000e+00 1.00000e+00 0.00000e+00
 200 0.00000e+00 0.00000e+00 1.00000e+00
  40 1.00000e+00 1.00000e+00 0.00000e+00
  22 1.00000e+00 0.00000e+00 1.00000e+00
1000 2.00000e+00 0.00000e+00 0.00000e+00
  55 0.00000e+00 2.00000e+00 0.00000e+00
  44 0.00000e+00 0.00000e+00 2.00000e+00
 202 2.00000e+00 2.00000e+00 0.00000e+00
 101 2.00000e+00 0.00000e+00 2.00000e+00
part 1
This is Part 1, a pretty strange Part
tria3
  2
 101 100 200 40
 201 101 5 1000
tetra4
  1
 102 100 202 101 1000
part 2
This is Part 2, it's pretty strange also
bar2
  1
 103 101 1000
```



## EnSight5 Result File Format

The Result file is an ASCII free format file that contains variable and time step information that pertains to a Particular geometry file. The following information is included in this file:

- Number of scalar variables
- Number of vector variables
- Number of time steps
- Starting file number extension and skip-by value
- Flag that specifies whether there is changing geometry
- Names of the files that contain the values of scalar and vector variables
- The names of the geometry files that will be used for the changing geometry.

The format of the EnSight5 result file is as follows:

- Line 1  
Contains the number of scalar variables, the number of vector variables and a geometry-changing flag. (If the geometry-changing flag is 0, the geometry of the model does not change over time. If it is 1, then there is connectivity changing geometry. If it is 2, then there is coordinate only changing geometry.)
- Line 2  
Indicates the number of time steps that are available.
- Line 3  
Lists the time that is associated with each time step. There must be the same number of values as are indicated in Line 2. This “line” can actually span several lines in the file. You do not have to have one very long line.
- Line 4  
Specified only if more than one time step is indicated in Line 2. The two values on this line indicate the file extension value for the first time step and the offset between files. If the values on this line are 0 5, the first time step available has a subscript of 0, the second time step available has a subscript of 5, the third time step has a subscript of 10, and so on.
- Line 5  
Contains the names of the geometry files that will be used for changing geometry. This line exists only if the flag on Line 1 is set to 1 or 2. The geometry file name must follow the EnSight5 wild card specification.
- Line 6 through Line [5+N] where N is the number of scalar variables specified in Line 1.  
List **BOTH** the file names **AND** variable description that correspond to each scalar variable. There must be a file name for each scalar variable that is specified in Line 1.

If there is more than one time step, the file name must follow the EnSight5 wild card specification. See Note below.

- Lines that follow the scalar variable files.

List the file names that correspond to each vector variable. There must be a file name for each vector variable that is specified in Line 1. If there is more than one time step, the file name must follow the EnSight5 wild card specification. See Note below.

*Note: Variable descriptions have the following restrictions:*  
*The variable description is limited to 19 characters in the current release.*  
*Duplicate variable descriptions are not allowed.*  
*Leading and trailing white space will be eliminated.*  
*Variable descriptions must not start with a numeric digit.*  
*Variable descriptions must not contain any of the following reserved characters:*

```
( [ + @ ! * $
) ] - space # ^ /
```

The generic format of a result file is as follows:

```
#_of_scalars #_of_vectors geom_chang_flag
#_of_timesteps
time1 time2 time3 .....
start_file_# skip_by_value
geometry_file_name.geo**
scalar0_file_name** description (19 characters max)
scalar1_file_name** description
.
.
.
vector0_file_name** description (19 characters max)
vector1_file_name** description
.
```

#### EnSight5 Result File Example 1

The following example illustrates a result file specified for a non-changing geometry file with only one time step:

```
2 1 0
1
0.0
exone.scl0 pressure
exone.scl1 temperature
exone.dis0 velocity
```

#### EnSight5 Result File Example 2

This example illustrates a result file that specifies a connectivity changing geometry that has multiple time steps.

```
1 2 1
4
1.0 2.0 2.5 5.0
0 1
extwo.geom**
pres.scl** pressure
vel.dis** velocity
grad.dis** gradient
```

The following files would be needed for example 2:

```
extwo.geom00 pres.scl00 vel.dis00 grad.dis00
extwo.geom01 pres.scl01 vel.dis01 grad.dis01
extwo.geom02 pres.scl02 vel.dis02 grad.dis02
extwo.geom03 pres.scl03 vel.dis03 grad.dis03
```

### EnSight5 Wild Card Name Specification

If multiple time steps are involved, the file names must conform to the EnSight5 wild-card specification. This specification is as follows:

- File names must include numbers that are in ascending order from beginning to end.
- Numbers in the files names must be zero filled if there is more than one significant digit.
- Numbers can be anywhere in the file name.
- When the file name is specified in the EnSight5 result file, you must replace the numbers in the file with an asterisk(\*). The number of asterisks specified is the number of significant digits. The asterisk must occupy the same place as the numbers in the file names.

### EnSight5 Variable File Format

Variables files have one description line followed by a value for each node. For a scalar file there is one value per node, while for vector files there are three values per node.

The values **must be written** in the following floating point format (**6 per line** as shown in the examples below):

From C:                   12.5e format

From FORTRAN:       e12.5 format

The format of a variables file is as follows:

- Line 1  
This line is a description line.
- Line 2 through the end of the file contains the values at each node in the model. A generic example:

```
A description line
*.*****E+** *.*****E+** *.*****E+** *.*****E+** *.*****E+** *.*****E+**
*.*****E+** *.*****E+** *.*****E+** *.*****E+** *.*****E+** *.*****E+**
*.*****E+** *.*****E+** *.*****E+** *.*****E+** *.*****E+** *.*****E+**
```

#### EnSight5 Variable File Example 1

This example shows a scalar file for a geometry with seven defined nodes.

```
These are the pressure values for a 7 node geometry
1.00000E+00 2.00000E+00 3.00000E+00 4.00000E+00 5.00000E+00 6.00000E+00
7.00000E+00
```

#### EnSight5 Variable File Example 2

This example shows the vector file for a geometry with seven defined nodes.

```
These are the velocity values for a 7 node geometry
1.00000E+00 1.00000E+00 1.00000E+00 2.00000E+00 2.00000E+00 2.00000E+00
3.00000E+00 3.00000E+00 3.00000E+00 4.00000E+00 4.00000E+00 4.00000E+00
```

```
5.00000E+00 5.00000E+00 5.00000E+00 6.00000E+00 6.00000E+00 6.00000E+00
7.00000E+00 7.00000E+00 7.00000E+00
```

## EnSight5 Measured/Particle File Format

This file allows you to define Particle locations, sizes, etc. to display with the geometry. Typical uses are fuel droplets for combustion analysis or data derived from experiments on prototypes.

The measured/Particle files consist of the following:

- Measured/Particle geometry file (referenced by the measured results file)
- Measured/Particle results file (the filename which is put into the Data Reader's "(Set) Measured" field)
- Measured/Particle variables file (referenced by the measured results file)

The format of the EnSight5 Measured/Particle geometry file is described below.

Note that there is only one description line and there *must* be an ID for each measured point.

Note also that the number of Particles can be different in each of the geometry file (if you have transient data), however, the number of values in each of the corresponding variable files must coincide, and the IDs of the Particles must be consistent in order to track the Particles at intermediate times or locations.

The format of an EnSight5 Measured/Particle geometry file is as follows:

- Line 1

This line is a description line.

- Line 2

Indicates that this file contains Particle coordinates. The words "particle coordinates" should be entered on this line without the quotes.

- Line 3

Specifies the number of Particles.

- Line 4 through the end of the file.

Each line contains the ID and the X, Y, and Z coordinates of each Particle. The format of this line is "integer real real real" written out in the following format:

From C:                    %8d%12.5e%12.5e%12.5e format

From FORTRAN:    i8, 3e12.5 format

A generic measured/Particle geometry file is as follows:

```
A description line
particle coordinates
#_of_Particles
id xcoord ycoord zcoord
id xcoord ycoord zcoord
id xcoord ycoord zcoord
```

.  
.  
.

*EnSight5 Measured  
Geometry/Particle  
File Example*

The following illustrates an EnSight5 Measured Geometry/Particle file with seven points:

This is a simple ensight5 measured geometry/particle file  
particle coordinates

```

7
101 0.00000E+00 0.00000E+00 0.00000E+00
102 1.00000E+00 0.00000E+00 0.00000E+00
103 1.00000E+00 1.00000E+00 0.00000E+00
104 0.00000E+00 1.00000E+00 0.00000E+00
205 5.00000E-01 0.00000E+00 2.00000E+00
206 5.00000E-01 1.00000E+00 2.00000E+00
307 0.00000E+00 0.00000E+00-1.50000E+00

```

*EnSight5 Measured/  
Particle File Format*

The format of the EnSight5 Measured/Particle results file is as follows:

- Line 1  
Contains the number of scalar variables, the number of vector variables, and a measured geometry changing flag. If the measured geometry changing flag is 0, only one time step is indicated.
- Line 2  
Indicates the number of available time steps.
- Line 3  
Lists the time that is associated with each time step. The time step information does not have to coincide with the model time step information. This “line” can actually span several lines in the file. You do not have to have one very long line.
- Line 4  
Specified only if Line 2 specifies more than one time step. The line contains two values; the first value indicates the file extension value for the first time step, and the second value indicates the offset between files. If this line contains the values 0 and 5, the first time step has a subscript of 0, the second of 5, the third of 10, and so on.
- Line 5  
Contains the name of the measured geometry file. If there is more than one time step, the file name must follow the EnSight wild card specification.
- Line 6 through Line [5+N] where N is the number of scalar variables specified in Line 1.  
List the file names that correspond to each scalar variable. There must be a file name for each scalar variable that is specified in Line 1. If there is more than one time step, the file name must follow the EnSight wild card

specification.

- Lines that follow the scalar variable files.

List the names of the files that correspond to each vector variable. There must be a file name for each vector variable that is specified in Line 1. If there is more than one time step, the file name must follow the EnSight wild card specification.

A generic EnSight5 Measured/Particle results file is as follows:

```
#_of_scalars #_of_vectors geom_chang_flag
#_of_timesteps
time1 time2 time3 .....
start_file_# skip_by_value
measured_geom_file_name**
scalar0_file_name**  description
scalar1_file_name**  description
.
.
.
vector0_file_name**  description
vector1_file_name**  description
.
.
.
```

*Measured/Particle  
Results File  
Example 1*

This example illustrates an EnSight5 Measured/Particle result file that specifies a non-changing geometry with only one time step:

```
2 1 0
1
0.0
exone.geom
exone.scl0 pressure
exone.scl1 temperature
exone.dis0 velocity
```

*Measured/Particle  
Results File  
Example 2*

This example illustrates an EnSight5 Measured/Particle result file that specifies a changing geometry with multiple time steps:

```
1 2 1
4
1.0 2.0 2.5 5.0
0 1
extwo.geom**
pres.scl** pressure
vel.dis** velocity
grad.dis** gradient
```

The following files are needed for Example 2:

```
extwo.geom00pres.scl00vel.dis00      grad.dis00
extwo.geom01pres.scl01vel.dis01      grad.dis01
extwo.geom02pres.scl02vel.dis02      grad.dis02
extwo.geom03pres.scl03vel.dis03      grad.dis03
```

*Measured /Particle  
Results Variable files*

The EnSight5 Measured/Particle variable files referred to in the measured Results file follow the same format as EnSight5 Variable files. The number of values in

each of these variable files must correspond properly to the number of Particles in the corresponding measured geometry files.

## Writing EnSight5 Binary Files

This section describes the EnSight5 binary files. This format is used to increase the speed of reading data into EnSight. A utility exists for converting EnSight5 ASCII files to EnSight5 binary files—it is called `asciitobin5` and is found on the release tape under `ensight/server/utilities/asciitobin5`.

For binary files, there is a header that designates the type of binary file. This header is: “C Binary” or “Fortran Binary.” This must be the first thing in the file. The format for the file is then essentially the same format as the ASCII format, with the following exceptions:

The ASCII format puts the node and element ids on the same “line” as the corresponding coordinates. The BINARY format writes all node id’s then all coordinates.

The ASCII format puts all element id’s of a type within a Part on the same “line” as the corresponding connectivity. The BINARY format writes all the element ids for that type, then all the corresponding connectivities of the elements.

In all the descriptions of binary files that follow, the number on the left end of the line corresponds to the type of write of that line, according to the following code:

1. This is a write of 80 characters to the file:

```
C example:  char buffer[80];
            strcpy(buffer,"C Binary");
            fwrite(buffer,sizeof(char),80,file_ptr);
```

```
FORTRAN:  character*80  buffer
            buffer = "Fortran Binary"
            write(10) buffer
```

2. This is a write of a single integer:

```
C example:  fwrite(&num_nodes,sizeof(int),1,file_ptr);
FORTRAN:  write(10) num_nodes
```

3. This is a write of an integer array:

```
C example:  fwrite(node_ids,sizeof(int),num_nodes,file_ptr);
FORTRAN:  write(10) (node_ids(i),i=1,num_nodes)
```

4. This is a write of a float array:

```
C example:  fwrite(coords,sizeof(float),3*num_nodes,file_ptr);
FORTRAN:  write(10) ((coords(i,j),i=1,3),j=1,num_nodes)
```

(Note: *Coords* is a single precision array, double precision will not work!)

*EnSight5 Binary*

*Geometry File Format* An EnSight5 binary geometry file contains information in the following order:

- (1) <C Binary/Fortran Binary>
- (1) description line 1
- (1) description line 2
- (1) node id <given/off/assign/ignore>
- (1) element id <given/off/assign/ignore>
- (1) coordinates
- (2) #\_of\_points
- (3) [point\_ids]
- (4) coordinate\_array
- (1) part #
- (1) description line
- (1) element\_type
- (2) #\_of\_element\_type
- (3) [element\_ids] for the element\_type
- (3) connectivities for the element\_type
- (1) element\_type
- (2) #\_of\_element\_type
- (3) [element\_ids] for the element\_type
- (3) connectivities for the element\_type
- .
- .
- .
- (1) part #
- (1) description line
- (1) element\_type
- (2) #\_of\_element\_type
- (3) [element\_ids] for the element\_type
- (3) connectivities for the element\_type
- (1) element\_type
- (2) #\_of\_element\_type
- (3) [element\_ids] for the element\_type
- (3) connectivities for the element\_type
- .
- .
- .

*Binary Scalar* An EnSight5 binary scalar file contains information in the following order:

- (1) description line
- (4) scalar\_array

*Binary Vector* An EnSight5 binary vector file contains information in the following order:

- (1) description line
- (4) vector\_array



*Binary Measured*

An EnSight5 binary measured/Particle geometry file contains information in the following order:

- (1) <C Binary/Fortran Binary>
- (1) description line 1
- (1) particle coordinates
- (2) #\_of\_points
- (3) point\_ids
- (4) coordinate\_array

## 11.4 FAST UNSTRUCTURED Results File Format

FAST UNSTRUCTURED input data consists of the following:

- Geometry file (required) (GRID file).
- Results file (optional).
- [EnSight5 Measured/Particle Files](#) (optional). The measured .res file references the measured geometry and variable files.

FAST UNSTRUCTURED data files can be read as:

Workstation: ASCII, C Binary, or FORTRAN binary

Cray: ASCII, C Binary, or COS-Blocked FORTRAN binary

Due to the different number of representations on a Cray Research vector system and workstations, binary files created on a Cray Research vector system can *not* be read on the workstation, and visa versa.

EnSight reads the geometry (grid files) directly. However, an EnSight-like results file is needed in order to read the results unless a “standard” Q-file is provided in its place. See FAST UNSTRUCTURED Result File below.

### *FAST UNSTRUCTURED Geometry file notes*

Only the single zone format can be read into EnSight. Any tetrahedral elements will be placed into the first “domain” Part. Triangular elements are placed into Parts based on their “tag” value.

The FAST UNSTRUCTURED solution file or function file formats can be used for variable results. The I J K values need to be I=Number of points and J=K=1. This does require the use of a modified EnSight results file as explained below.

Node and element numbers are assigned sequentially allowing for queries to be made within EnSight. Tetrahedron elements will be assigned before triangular elements.

### *FAST UNSTRUCTURED Result file format*

The FAST UNSTRUCTURED result file was defined by CEI and is very similar to the EnSight results file and contains information needed to relate variable names to variable files, step information, etc. There is a slight variation from the normal EnSight results file because of the differences between the solution (Q file) and function files. The difference lies on the lines which relate variable filenames to a description. These lines have the following format:

```
<filename> <type> <number(s)> <description>
```

See FAST UNSTRUCTURED Result File below for the definition of each.

The following information is included in a FAST UNSTRUCTURED result file:

- Number of scalar variables
- Number of vector variables
- Number of time steps

- Starting file number extension and skip-by value
- Flag that specifies whether there is changing geometry.
- Names of the files that contain the values of scalar and vector variables. An indication as to the type of the file being used for the variable, which variable in the file and the name given to that variable.
- The names of the geometry files that will be used for the changing geometry.

*Generic FAST UNSTRUCTURED Result File Format*

The format of the Result file is as follows:

- Line 1  
Contains the number of scalar variables, the number of vector variables and a geometry changing flag. If the geometry changing flag is 0, the geometry of the model does not change over time. If the flag is 1, the geometry can change connectivity. If the flag is 2, only coordinates can change.
- Line 2  
Indicates the number of time steps that are available. If this number is positive, then line 3 information must be present. If this number is negative, then Line 3 information must not be present and the times will be read from the solution file. Thus, one must have a solution file in one of the lines from Line 6 on.
- Line 3  
Lists the time that is associated with each time step. There must be the same number of values as are indicated in Line 2. This “line” can actually span several lines in the file. Specify only if Line 2 value is positive.
- Line 4  
Specified only if more than one time step is indicated in Line 2. The two values on this line indicate the file extension value for the first time step and the offset between files. If the values on this line are 0 5, the first time step available has a subscript of 0, the second time step available has a subscript of 5, the third time step has a subscript of 10, and so on.
- Line 5  
This line exists only if the changing geometry flag on Line 1 has been set to 1 or 2. Line contains name of the FAST UNSTRUCTURED grid file. The file name must follow the EnSight wild card specification.
- Line 6 through Line [5+N] where N is the number of scalar variables specified in Line 1.  
List the file names that correspond to each scalar variable. There must be a file name for each scalar variable that is specified in Line 1. If there is more than one time step, the file name must follow the EnSight wild card specification.  
These lines also contain the type of file being used, solution or function, and the location of the variable value in the file. The contents are:

```
<filename> <type> <number> <description>
```

where filename is the name of solution file or function file containing the variable; type is “S” for solution file, or “F” for function file; number is which variable in the file to use (specify just one number); and description is the Description of the variable.

The solution file (“s”) is the traditional .q file in which normally the first variable is density, the second through fourth variables are the components of momentum, and the fifth variable is total energy.

- Lines that follow the scalar variable files.

List the file names that correspond to each vector variable. There must be a file name for each vector variable that is specified in Line 0. If there is more than one time step, the file name must follow the EnSight wild card specification.

These lines also contain the type of file being used, solution or function, and the location(s) of the variable values in the file. The contents are:

```
<filename> <type> <numbers> <description>
```

where filename is the name of solution file or function file containing the variable; type is “S” for solution file, or “F” for function file; numbers are which variables in the file to use (specify just three numbers); and description is the Description of the variable.

The generic format of the result file is as follows:

```
#_of_scalars #_of_vectors geom_chng_flag
#_of_timesteps
time1 time2 time3 .....
start_file_# skip_by_value
geometry_file_name.geo**
scalar0_file_name** type # description
scalar1_file_name** type # description
.
.
.
vector0_file_name** type # # # description
vector1_file_name** type # # # description
.
.
.
```

*FAST UNSTRUCTURED* This example illustrates a result file that specifies a non-changing geometry with one time step.

*Example*

```
3 2 0
1
0.0
block.sol S 1 Density
block.sol S 5 Total_Energy
block.scl F 1 Temperature
block.var F 1 2 3 Displacement
block.sol S 2 3 4 Momentum
```

Thus, this model will get two scalars from the solution file (block.sol). The first is Density in the first location in the file and the next is Total energy in the fifth

location in the solution file. It will also get a Temperature scalar from the first location in the function file (block.scl).

It will get a Displacement vector from the function file called block.var. The three components of this vector are in the 1st, 2nd, and 3rd locations in the file. Finally, a Momentum vector will be obtained from the 2nd, 3rd, and 4th locations of the solution file.

Example 2 is somewhat similar, except that it is transient, with coordinate changing geometry. Note also that the times will come from the solution file.

```
3 2 2
-10
0 1
block***.grid
block***.sol S 1 Density
block***.sol S 5 Total_Energy
block***.scl F 1 Temperature
block***.var F 1 2 3 Displacement
block***.sol S 2 3 4 Momentum
```

## 11.5 FLUENT UNIVERSAL Results File Format

This section describes the FLUENT results file format and provides an example of this file. For transient cases, you *must* supply this result file. For static models this file is not required. The FLUENT result file is a slightly modified EnSight5 results file and provides a way to describe multiple time-step FLUENT Universal files to EnSight.

When using multiple FLUENT files with this result file definition, you *must* make sure that the files contain the same defined variables. In other words, any variable that exists in one must exist in all.

The Result file is an ASCII free format file that contains time step and universal file information for each available time step. The following information is included in this file:

- Number of time steps
- Simulation Time Values
- Starting file number extension and skip-by value
- Name of the universal file with EnSight wild card specification.

The format of the Result file is as follows:

- Line 1  
Indicates the number of time steps that are available.
- Line 2  
Lists the time that is associated with each time step. There must be the same number of values as are indicated in Line 1. This “line” can actually span several lines in the file. You do not have to have one very long line.
- Line 3  
Specified only if more than one time step is indicated in Line 1. The two values on this line indicate the file extension value for the first time step and the offset between files. If the values on this line are 0 5, the first time step available has a subscript of 0, the second time step available has a subscript of 5, the third time step has a subscript of 10, and so on.
- Line 4  
Contains the names of the universal file that will be used for the changing time step information. The universal file name must follow the EnSight5 wild card specification.

The generic format of the result file is as follows:

```
#_of_timesteps
time1 time2 time3 .....
start_file_# skip_by_value
universal_file_name***
```

*FLUENT Example*

This example illustrates a FLUENT result file

```
4
1.0 2.0 3.0 4.0
0 1
extwo**.uni
```

The following FLUENT universal files will need to exist for the result file:

```
extwo00.uni
extwo01.uni
extwo02.uni
extwo03.uni
```

## 11.6 Movie.BYU Results File Format

For transient cases, you must supply an EnSight result file. The result file for the Movie.BYU case is exactly the same as for EnSight5 (it is repeated below for your ease).

The Result file is an ASCII free format file that contains variable and time step information that pertains to a Particular geometry file. The following information is included in this file:

- Number of scalar variables
- Number of vector variables
- Number of time steps
- Starting file number extension and skip-by value
- Flag that specifies whether there is changing geometry
- Names of the files that contain the values of scalar and vector variables
- The names of the geometry files that will be used for the changing geometry.

The format of the Movie.BYU (EnSight5) result file is as follows:

- Line 1  
Contains the number of scalar variables, the number of vector variables and a geometry-changing flag. (If the geometry-changing flag is 0, the geometry of the model does not change over time. If it is 1, then there is connectivity changing geometry. If it is 2, then there is coordinate only changing geometry.)
- Line 2  
Indicates the number of time steps that are available.
- Line 3  
Lists the time that is associated with each time step. There must be the same number of values as are indicated in Line 2. This “line” can actually span several lines in the file. You do not have to have one very long line.
- Line 4  
Specified only if more than one time step is indicated in Line 2. The two values on this line indicate the file extension value for the first time step and the offset between files. If the values on this line are 0 5, the first time step available has a subscript of 0, the second time step available has a subscript of 5, the third time step has a subscript of 10, and so on.
- Line 5  
Contains the names of the geometry files that will be used for changing geometry. This line exists only if the flag on Line 1 is set to 1 or 2. The geometry file name must follow the EnSight5 wild card specification.
- Line 6 through Line [5+N] where N is the number of scalar variables specified in Line 1.



List **BOTH** the file names **AND** variable description that correspond to each scalar variable. There must be a file name for each scalar variable that is specified in Line 1.

If there is more than one time step, the file name must follow the EnSight5 wild card specification. See Note below.

- Lines that follow the scalar variable files.

List the file names that correspond to each vector variable. There must be a file name for each vector variable that is specified in Line 1. If there is more than one time step, the file name must follow the EnSight5 wild card specification. See Note below.

*Note: Variable descriptions have the following restrictions:*  
*The variable description is limited to 19 characters in the current release.*  
*Duplicate variable descriptions are not allowed.*  
*Leading and trailing white space will be eliminated.*  
*Variable descriptions must not start with a numeric digit.*  
*Variable descriptions must not contain any of the following reserved characters:*

```
( [ + @ ! * $
) ] - space # ^ /
```

The generic format of a result file is as follows:

```
#_of_scalars #_of_vectors geom_chang_flag
#_of_timesteps
time1 time2 time3 .....
start_file_# skip_by_value
geometry_file_name.geo**
scalar0_file_name** description (19 characters max)
scalar1_file_name** description
.
.
.
vector0_file_name** description (19 characters max)
vector1_file_name** description
.
```

#### Movie.BYU Result File Example 1

The following example illustrates a result file specified for a non-changing geometry file with only one time step:

```
2 1 0
1
0.0
exone.scl0 pressure
exone.scl1 temperature
exone.dis0 velocity
```

#### Movie.BYU Result File Example 2

This example illustrates a result file that specifies a connectivity changing geometry that has multiple time steps.

```
1 2 1
4
1.0 2.0 2.5 5.0
0 1
extwo.geom**
pres.scl** pressure
```

```
vel.dis** velocity  
grad.dis** gradient
```

The following files would be needed for example 2:

```
extwo.geom00 pres.scl00 vel.dis00 grad.dis00  
extwo.geom01 pres.scl01 vel.dis01 grad.dis01  
extwo.geom02 pres.scl02 vel.dis02 grad.dis02  
extwo.geom03 pres.scl03 vel.dis03 grad.dis03
```

## 11.7 PLOT3D Results File Format

PLOT3D input data consists of the following:

- Geometry file (required) (GRID file).
- Results file (optional).
- [EnSight5 Measured/Particle Files](#) (optional). The measured .res file references the measured geometry and variable files.

PLOT3D data files can be read as:

Workstation: ASCII, C Binary, or FORTRAN binary

Cray: ASCII, C Binary, or COS-Blocked FORTRAN binary

(see [PLOT3D Reader](#), in [Section 2.3](#))

Due to the different number of representations on a Cray Research vector system and workstations, binary files created on a Cray Research vector system can *not* be read on the workstation, and visa versa.

EnSight attempts to ensure that the format of the file being read matches the format you have selected in the Data Reader dialog. However, if you specify that the file is C binary, and it is really FORTRAN binary, this will not be detected and erroneous values will be loaded.

EnSight reads the geometry (xyz files) directly. However, an EnSight-like results file (described below) is needed in order to read the results, unless a “standard” Q-file is provided in its place.

### *PLOT3D Geometry file notes*

The following information is required in order to read PLOT3D files correctly:

1. whether there is Iblanking information in the file
2. whether files are in ASCII, C Binary, or FORTRAN binary
3. whether the file is “Single Zone” or Multi-Zoned”
4. whether the model is 1D, 2D, or 3D in nature.

Iblanking can be one of the following:

0 = Outside (Blanked Out)

1 = Inside

2 = Interior boundaries

<0 = zone that neighbors

If single zone with Iblanking, you can build EnSight Parts from the inside portions, blanked-out portions, or internal boundary portions. If single zone, you can also specify I, J, K limiting ranges for Parts to be created.

If Multi-zoned with Iblanking, you can additionally build Parts that are the boundary between two zones. (For boundary you must specify exactly two zones.)

If Multi-zoned and not using the “between boundary” option, a Part can span several zones.

If Multi-zoned, the dimension of the problem is forced to be 3D.

There can be nodes in different zones which have the same coordinates. No attempt has been made to merge these. Thus, on shared zone boundaries, there will likely be nodes on top of nodes. One negative effect of this is that node labels will be on top of each other.

Currently EnSight only prints out the global conditions in the solution file, fsmach, alpha, re, and time. It does not do anything else with them.

Node and element numbers are assigned in a sequential manner. Queries can be made on these node and element numbers or on nodes by I, J, and K.

### *PLOT3D Result file format*

The PLOT3D result file was defined by CEI and is very similar to the EnSight results file and contains information needed to relate variable names to variable files, step information, etc. There is a slight variation from the normal EnSight results file because of the differences between the solution (Q file) and function files. The difference lies on the lines which relate variable filenames to a description. These lines have the following format:

```
<filename> <type> <number(s)> <description>
```

See PLOT3D Result File below for the definition of each.

The following information is included in a PLOT3D result file:

- Number of scalar variables
- Number of vector variables
- Number of time steps
- Starting file number extension and skip-by value
- Flag that specifies whether there is changing geometry.
- Names of the files that contain the values of scalar and vector variables. An indication as to the type of the file being used for the variable, which variable in the file and the name given to that variable.
- The names of the geometry files that will be used for the changing geometry.

### *Generic PLOT3D Result File Format*

The format of the Result file is as follows:

- Line 1  
Contains the number of scalar variables, the number of vector variables and a geometry changing flag. If the geometry changing flag is 0, the geometry of the model does not change over time. Only the coordinates can change for a PLOT3D file at present time.
- Line 2  
Indicates the number of time steps that are available.

- Line 3

Lists the time that is associated with each time step. There must be the same number of values as are indicated in Line 2. This “line” can actually span several lines in the file.

- Line 4

Specified only if more than one time step is indicated in Line 2. The two values on this line indicate the file extension value for the first time step and the offset between files. If the values on this line are 0 5, the first time step available has a subscript of 0, the second time step available has a subscript of 5, the third time step has a subscript of 10, and so on.

- Line 5

This line exists only if the changing geometry flag on Line 1 has been set to 1. Line contains name of the PLOT3D xyz file. The file name must follow the EnSight wild card specification.

- Line 6 through Line [5+N] where N is the number of scalar variables specified in Line 1.

List the file names that correspond to each scalar variable. There must be a file name for each scalar variable that is specified in Line 1. If there is more than one time step, the file name must follow the EnSight wild card specification.

These lines also contain the type of file being used, solution or function, and the location of the variable value in the file. The contents are:

```
<filename> <type> <number> <description>
```

where filename is the name of solution file or function file containing the variable; type is “S” for solution file, or “F” for function file; number is which variable in the file to use (specify just one number); and description is the Description of the variable.

The solution file (“s”) is the traditional .q file in which normally the first variable is density, the second through fourth variables are the components of momentum, and the fifth variable is total energy.

- Lines that follow the scalar variable files.

List the file names that correspond to each vector variable. There must be a file name for each vector variable that is specified in Line 1. If there is more than one time step, the file name must follow the EnSight wild card specification.

These lines also contain the type of file being used, solution or function, and the location(s) of the variable values in the file. The contents are:

```
<filename> <type> <numbers> <description>
```

where filename is the name of solution file or function file containing the variable; type is “S” for solution file, or “F” for function file; numbers are which variables in the file to use (specify just three numbers); and description is the Description of the variable.

The generic format of the result file is as follows:

```
#_of_scalars #_of_vectors geom_chng_flag
#_of_timesteps
time1 time2 time3 .....
start_file_# skip_by_value
geometry_file_name.geo**
scalar0_file_name** type # description
scalar1_file_name** type # description
.
.
.
vector0_file_name** type # # # description
vector1_file_name** type # # # description
.
.
.
```

### *PLOT3D Example*

This example illustrates a result file that specifies a non-changing geometry with only one time step.

```
3 2 0
1
0.0
block.sol S 1 Density
block.sol S 5 Total_Energy
block.scl F 1 Temperature
block.var F 1 2 3 Displacement
block.sol S 2 3 4 Momentum
```

Thus, this model will get two scalars from the solution file (block.sol). The first is Density in the first location in the file and the next is Total energy in the fifth location in the solution file. It will also get a Temperature scalar from the first location in the function file (block.scl).

It will get a Displacement vector from the function file called block.var. The three components of this vector are in the 1st, 2nd, and 3rd locations in the file. Finally, a Momentum vector will be obtained from the 2nd, 3rd, and 4th locations of the solution file.

Vectors can be 1D, 2D, or 3D. For a vector, always provide three numbers, but a zero will indicate that a component is empty, thus:

```
block.var F 1 0 3 XZ_Displacement
```

would be a 2D vector variable with components only in the X–Z plane.

If the above example had transient variables (but not geometry), with 3 time steps, it would appear as:

```
3 2 0
3
0.0 1.5 4.0
1 1
block.sol** S 1 Density
block.sol** S 5 Total_Energy
block.scl** F 1 Temperature
block.var** F 1 2 3 Displacement
block.sol** S 2 3 4 Momentum
```

The files needed would then be:

```

block.sol01      block.scl01      block.var01
block.sol02      block.scl02      block.var02
block.sol03      block.scl03      block.var03

```

And if the geometry changed as well as the variables, it would appear as:

```

3 2 1
3
0.0 1.5 4.0
1 1
block.geo**
block.sol** S 1 Density
block.sol** S 5 Total_Energy
block.scl** F 1 Temperature
block.var** F 1 2 3 Displacement
block.sol** S 2 3 4 Momentum

```

The files needed would then be:

```

block.sol01      block.scl01      block.var01      block.geo01
block.sol02      block.scl02      block.var02      block.geo02
block.sol03      block.scl03      block.var03      block.geo03

```

*Note: A “standard” Q-file can be substituted for PLOT3D result file format if desired. A “standard” Q-file has 5 variable components (First is density, then the three components of momentum, and last is energy).*

## 11.8 Server-of-Server Casefile Format

ensight8 (with gold license key) has the capability of dealing with partitioned data in an efficient distributed manner by utilizing what we call a server-of-servers (SOS for short). An SOS server resides between a normal client and a number of normal servers. Thus, it appears as a normal server to the client, and as a normal client to the various normal servers.

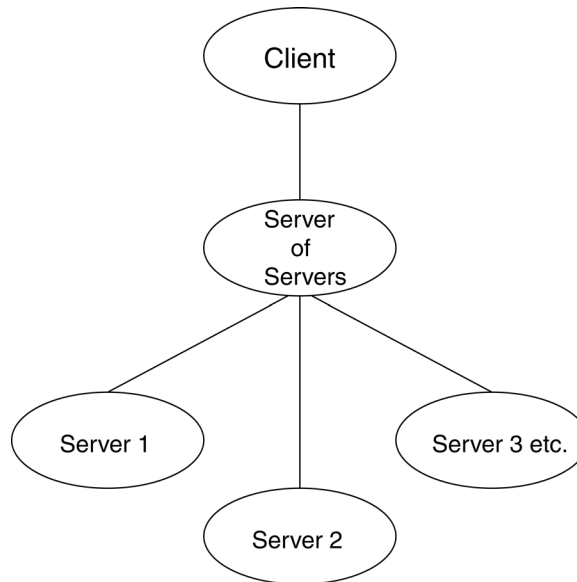

This arrangement allows for distributed parallel processing of the various portions of a model, and has been shown to scale quite well.

Currently, EnSight SOS capability is only available for EnSight5, EnSight6, EnSight Gold, Plot3d, and any EnSight User-Defined Reader data. (It is not directly available for Fidap Neutral, Fluent Universal, N3S, Estet, MPGS4, Movie, Ansys, Abaqus, or FAST Unstructured data.)

Please recognize that your data must be partitioned in some manner (hopefully in a way that will be reasonably load balanced) in order for this approach to be useful. (The one exception to this is the use of the `auto_distribute` capability for structured data. This option can be used if the data is structured and is available to all servers defined. It will automatically distribute each structured block over the defined servers - without the user having to partition the data.)

*(Included in the EnSight distribution is an unsupported utility that will take most EnSight Gold binary unstructured datasets and partition it for you. The source for this utility (called "chopper") can be found in the `$CEI_HOME/ensight80/unsupported/partitioner` directory.)*

Note: If you do your own partitioning of data into EnSight6 or EnSight Gold format, please be aware that each part must be in each partition - but, any given part can be "empty" in any given partition. (All that is required for an empty part is the "part" line, the part number, and the "description" line.)

You should place each partitioned portion of the model on the machine that will compute that portion. Each partitioned portion is actually a self contained set of



EnSight data files, which could typically be read by a normal client - server session of EnSight. For example, if it were EnSight gold format, there will be a casefile and associated gold geometry and variable results file(s). On the machine where the EnSight SOS will be run, you will need to place the sos casefile. This is a simple ascii file which informs the SOS about pertinent information need to run a server on each of the machines that will compute the various portions.

The format for the SOS casefile is as follows: (Note that [ ] indicates optional information, and a blank line or a line with # in the first column are comments.)

FORMAT (Required)

type: master\_server *datatype* (Required)

where: *datatype* is required and is one of the formats of EnSight's internal readers (which use the Part builder), namely:

gold      ensight6    ensight5    plot3d

or it can be the string used to name any of the user-defined readers.

Note: For user-defined readers, the string must be exactly that which is defined in the USERD\_get\_name\_of\_reader routine of the reader (which is what is presented in the Format pulldown of the Data Reader dialog).

If *datatype* is blank, it will default to EnSight6 data type.

[auto\_distribute: *on/off*] (Optional for structured, Ignored for unstructured)

For structured data only, EnSight will automatically distribute data to the servers specified below if this option is present and set to "on". This will require that each of the servers have access to the same data (or identical copies of it).

[plot3d\_iblanked: *true/false*] (Required only if *datatype* is plot3d)

[plot3d\_multi\_zone: *true/false*] (Required only if *datatype* is plot3d)

[plot3d\_dimension: *1d/2d/3d*] (Required only if *datatype* is plot3d)

[plot3d\_source: *ascii/cbin/fortranbin*] (Required only if *datatype* is plot3d)

[plot3d\_grid\_double: *true/false*] (Required only if *datatype* is plot3d)

[plot3d\_results\_double: *true/false*] (Required only if *datatype* is plot3d)

where: iblanking, multi\_zone, dimension, source type, grid file double precision, and results file double precision information should be provided. If it is not provided, it will default to the following (which is likely not to be correct):

```
plot3d_iblanked:    false
plot3d_muti_zone:   false
plot3d_dimension:   3d
plot3d_source:      cbin
plot3d_grid_double: false
plot3d_results_double: false
```

NETWORK\_INTERFACES (Note: this whole section is optional. It is needed only when more than one network interface to the sos host is available and it is desired to use them. Thus distributing the servers to sos communication over more than one network interface)

number of network interfaces: *num* (Required - if section used)

where: *num* is the number of network interfaces to be used for the sos host.

network interface: *sos\_network\_interface\_name1*(Required - if section is used)

network interface: *sos\_network\_interface\_name2*(Required - if section is used)

.

.

network interface: *sos\_network\_interface\_namenum*(Required - if section used)

**SERVERS** (Required)

number of servers: *num* (Required)

where: *num* is the number of servers that will be started and run concurrently.

**#Server 1** (Comment only)

machine id: *mid* (Required)

where: *mid* is the machine id of the server.

executable: *../ensight8.server* (Required, must use full path)

[directory: *wd*] (Optional)

where: *wd* is the working directory from which ensight8.server will be run

[login id: *id*] (Optional)

where: *id* is the login id. Only needed if it is different on this machine.

[data\_path: *../dd*] (Optional)

where: *dd* is the data where the data resides. Full path must be provided if you use this line.

casefile: *yourfile.case* (Required, but depending on format, may vary as to whether it is a casefile, geometry file, neutral file, universal file, etc. Relates to the first data field of the Data Reader Dialog.)

[resfile: *yourfile.res*] (Depends on format as to whether required or not. Relates to the second data field of the Data Reader Dialog.)

[measfile: *yourfile.meas*] (Depends on format as to whether required or not. Relates to the third data field of the Data Reader Dialog.)

[bndfile: *yourfile.bnd*] (Depends on format as to whether required or not. Relates to the fourth data field of the Data Reader Dialog.)

**#Server 2** (Comment only)

--- Repeat pertinent lines for as many servers as declared to be in this file ---

### Example

This example deals with a EnSight Gold dataset that has been partitioned into 3 portions, each running on a different machine. The machines are named joe, sally, and bill. The executables for all machines are located in similar locations, but the data is not. Note that the optional data\_path line is used on two of the servers, but not the third.

```

FORMAT
type: master_server gold

SERVERS
number of servers: 3

#Server 1
machine id: joe
executable: /usr/local/bin/ensight80/bin/ensight8.server
data_path: /usr/people/john/data
casefile: portion_1.case

#Server 2
machine id: sally
executable: /usr/local/bin/ensight80/bin/ensight8.server
data_path: /scratch/sally/john/data
casefile: portion_2.case

#Server 3
machine id: bill
executable: /usr/local/bin/ensight80/bin/ensight8.server
casefile: /scratch/temp/john/portion_3.case

```

If we name this example sos casefile - “all.sos”, and we run it on yet another machine - one named george, you would want the data distributed as follows:

On george: all.sos

On joe (in /usr/people/john/data): portion\_1.case, and all files referenced by it.

On sally (in /scratch/sally/john/data): portion\_2.case, and all files referenced by it.

On bill (in /scratch/temp/john): portion\_3.case, and all file referenced by it.

By starting EnSight with the -sos command line option (which will autoconnect using ensight8.sos instead of ensight8.server), or by manually running ensight8.sos in place of ensight8.server, and providing all.sos as the casefile to read in the Data Reader dialog - EnSight will actually start three servers and compute the respective portions on them in parallel.

#### Optional NETWORK\_INTERFACES section notes

If the machine named george had more than one network interface (say it had its main one named george, but also had one named george2), we could add the section shown below to our casefile example:

```

NETWORK_INTERFACES
number of network interfaces: 2
network interface: george
network interface: george2

```

This would cause machine joe to connect back to george, machine sally to connect back to george2, and machine bill to connect back to george. This is because the sos is cycling through its available interfaces as it connects the servers. Remember that this is an optional section, and most users will probably not use it. Also, the contents of this section will be ignored if the -soshostname command line option is used.

*Additional Note: The EnSight SOS provided with release 8.0 supports most EnSight features. Some query operations with constants are not yet supported, but should be in a future release.*

## 11.9 Periodic Matchfile Format

This is an optional file which can be used in conjunction with models which have rotational or translational computational symmetry (or periodic boundary conditions). It is invoked in the GEOMETRY section of the EnSight casefile, using the “match: filename” line. (see Section , EnSight6 Case File Format).

When a model piece is created with periodic boundary conditions, there is usually a built-in correspondence between two faces of the model piece. If you transform a copy of the model piece properly, face 1 of the copy will be at the same location as face 2 of the original piece. It is desirable to know the corresponding nodes between face 1 and face 2 so border elements will not be produced at the matching faces. This correspondence of nodes can be provided in a periodic match file as indicated below. (Please note that if a periodic match file is not provided, by default EnSight will attempt to determine this correspondence using a float hashing scheme. This scheme has been shown to work quite well, but may not catch all duplicates. The user has some control over the “capture” accuracy of the hashing through the use of the command: “test: float\_hash\_digits”. If this command is issued from the command dialog, the user can change the number of digits, in a normalized scheme, to consider in the float hashing. The lower the number of digits, the larger the “capture” distance, and thus the higher the number of digits, the smaller the capture distance. The default is 4, with practical limits between 2 and 7 or 8 in most cases.)

The transformation type and delta value are contained in the file. The periodic match file is an ASCII free format file. For unstructured data, it can be thought of as a series of node pairs, where a node pair is the node number of face 1 and its corresponding node number on face 2. For structured blocks, all that is needed is an indication of whether the i, j, or k planes contain the periodic face. The min plane of this “direction” will be treated as face 1, and the max plane will be treated as face 2.

The file format is as follows:

rotate_x/y/z / translate	The first line is either rotate_x, rotate_y, rotate_z or translate
theta / dx dy dz	The second line contains rotation angle in degrees or the three translational delta values.
np n <sub>11</sub> n <sub>21</sub> n <sub>12</sub> n <sub>22</sub> . . . . . . n <sub>1np</sub> n <sub>2np</sub>	If any unstructured pairs, the third line contains the number of these pairs (np).  And the node ids of each pair follow. (The first subscript indicates face, the second is pair.)
blocks b <sub>min</sub> b <sub>max</sub> i/j/k	Last in the file comes as many of these “blocks” lines as needed. b <sub>min</sub> and b <sub>max</sub> are a range of block numbers. For a single block, b <sub>min</sub> and b <sub>max</sub> would be the same. Only one of i, j, or k can be specified for a given block.

Simple unstructured rotational example:

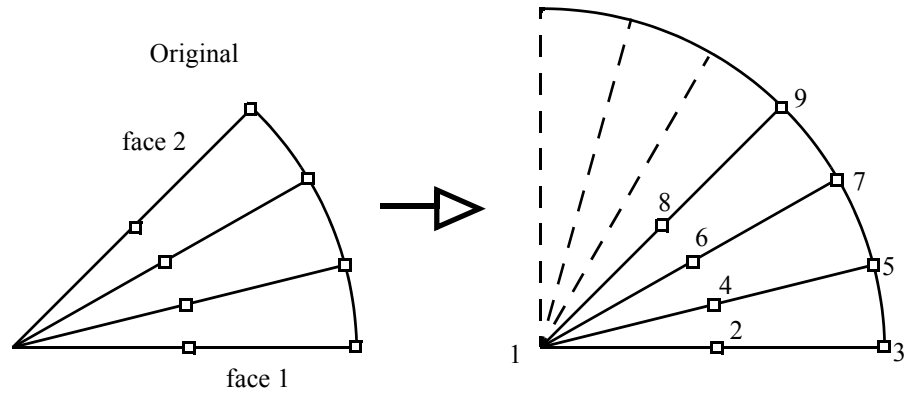

Figure 11-5  
Model Duplication by rotational symmetry

The periodic match file for a rotation of this model about point 1 would be:

```
rotate_z
45.0
3
1 1
2 8
3 9
```

Thus, face 1 of this model is made up of nodes 1, 2, and 3 and face 2 of this model is made up of nodes 1, 8, and 9. So there are 3 node pairs to define, with node 1 corresponding to node 1 after a copy is rotated, node 2 corresponding to node 8, and node 3 corresponding to node 9.

Simple structured translational model:

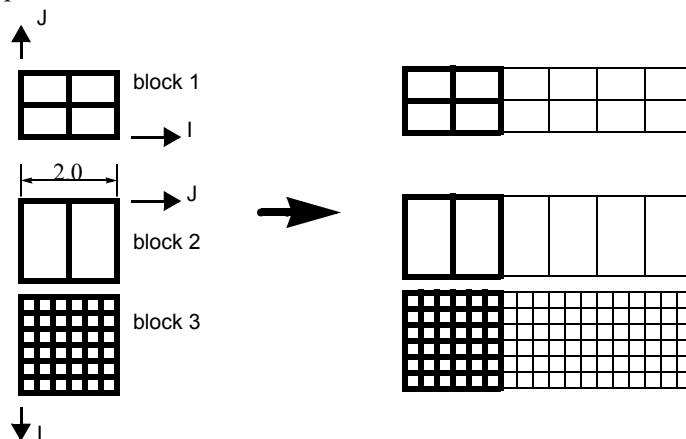

Figure 11-6  
Model Duplication by translational symmetry  
of structured blocks (3 instances)

```
translate
2.0 0.0 0.0
blocks 1 1 i
blocks 2 3 j
```

Since block 1 is oriented differently than blocks 2 and 3 in terms of ijk space, two “blocks” lines were needed in the match file.

**Special Notes / Limitations:**

1. This match file format requires that the unstructured node ids of the model be unique. This is only an issue with EnSight Gold unstructured format, since it is possible with that format to have non-unique node ids.
2. The model instance (which will be duplicated periodically) must have more than one element of thickness in the direction of the duplication. If it has only one element of thickness, intermediate instances will have all faces removed. If you have this unusual circumstance, you will need to turn off the shared border removal process, as explained in note 3.
3. The shared border removal process can be turned off, thereby saving some memory and processing time, by issuing the “test: rem\_shared\_bord\_off” command in the command dialog. The effect of turning it off will be that border elements will be left between each periodic instance on future periodic updates.
4. The matching and hashing processes actually occur together. Thus, matching information does not have to be specified for all portions of a model. If no matching information is specified for a given node, the hashing process is used. By the same token, if matching information is provided, it is used explicitly as specified - even if it is has been specified incorrectly.

## 11.10XY Plot Data Format

This file is saved using the Save section of the Query Entity dialog. The file can contain one or more curves. The following is an example XY Data file:

Line	Contents of Line
1	2
2	Distance vs. Temperature for Line Tool
3	Distance
4	Temperature
5	1
6	5
7	0.0 4.4
8	1.0 5.8
9	2.0 3.6
10	3.0 4.6
11	4.0 4.8
12	Distance vs. Pressure for Line Tool
13	Distance
14	Pressure
15	2
16	4
17	0.00 1.2
18	0.02 1.1
19	0.04 1.15
20	0.06 1.22
21	3
22	1.10 1.30
23	1.12 1.28
24	1.14 1.25

Line 1 contains the (integer) number of curves in the file.

Line 2 contains the name of the curve.

Line 3 contains the name of the X-Axis.

Line 4 contains the name of the Y-Axis.

Line 5 contains the number of curve segments in this curve.

Line 6 contains the number of points in the curve segment.

Lines 7-11 contain the X-Y information.

Line 12 contains the name of the second curve.

Line 13 contains the name of the X-Axis

Line 14 contains the name of the Y-Axis

Line 15 contains the number of curve segments in this curve. (For the second curve, the first segment contains 4 points, the second 3 points.)



## 11.11 EnSight Boundary File Format

This file format can be used to represent boundary surfaces of structured data as unstructured parts. The boundaries defined in this file can come from sections of several different structured blocks. Thus, inherent in the file format is a grouping and naming of boundaries across multiple structured blocks.

Additionally, a delta can be applied to any boundary section to achieve the creation of repeating surfaces (such as blade rows in a jet engine).

Note: There is no requirement that the boundaries actually be on the surface of blocks, but they must define either 2D surfaces or 1D lines. You may not use this file to define 3D portions of the block.

The boundary file is read if referenced in the casefile of EnSight data models, or in the boundary field of the Data Reader Dialog for other data formats. Any boundaries successfully read will be listed in the Unstructured Data Part List of the Data Part Loader Dialog.

The format of the EnSight Boundary File is as follows:

Line (1): Required header keyword and version number. ENSBND is required exactly, but the version number could change in the future.

```
ENSBND 1.00
```

Line (2) through Line (NumBoundaries+1): The names of the boundaries to be defined. (Each name must be no greater than 79 characters.)

For example:

```
inflow
wall
Chimera Boundary
outflow
```

Line (NumBoundaries+2): Required keyword indicating the end of the boundary names and the beginning of the boundary section definitions.

```
BOUNDARIES
```

Line (NumBoundaries+3) through the end of the file: The boundary section definitions. Each line will have the following information:

```
bnd_num blk_num imin imax jmin jmax kmin kmax [di dj dk n_ins]
```

where:

**bnd\_num** is the number of the boundary in the list of names above. (For example: inflow is 1, wall is 2, Chimera Boundary is 3, etc.)

**blk\_num** is the parent structured block for this boundary section.

**imin,imax, jmin,jmax, kmin,kmax** are the ijk ranges for the boundary section. At least one of the min,max pairs must refer to the same plane. A wildcard (“\$”) can be used to indicate the maximum i, j, or k value of that block (the far plane). Additionally, negative numbers can be used to indicate plane values from the far side toward the near side. (-1 = far plane, -2 = one less than the far plane, etc.)

[**di,dj,dk** and **n\_ins**] are optional delta information which can be used to extract repeating planes. The appropriate di, dj, or dk delta value should be set to the

repeating plane offset value, and the other two delta values must be zero. The non-zero delta must correspond to a min,max pair that are equal. The  $n\_ins$  value is used to indicate the number of repeating instances desired. A (“\$”) wildcard can be used here to indicate that the maximum number of instances that fit in the block should be extracted.

All numbers on the line must be separated by spaces.

Finally, comment lines are allowed in the file by placing a “#” in the first column.

Below is a simple example of a boundary file for two structured blocks, the first of which is a 3 x 3 x 3 block, and the second is a 10 x 10 x 10 block. We will define a boundary which is the front and back planes of each block(K planes) and one that is the top and bottom planes of each block(J planes). We will also define some repeating x planes, namely, planes at  $i=1$  and 3 for block one and at  $i=1, 4, 7,$  and 10 for block two. The image below shows the blocks in wire frame and the boundaries shaded and slightly cut away, so you can see the interior x-planes.

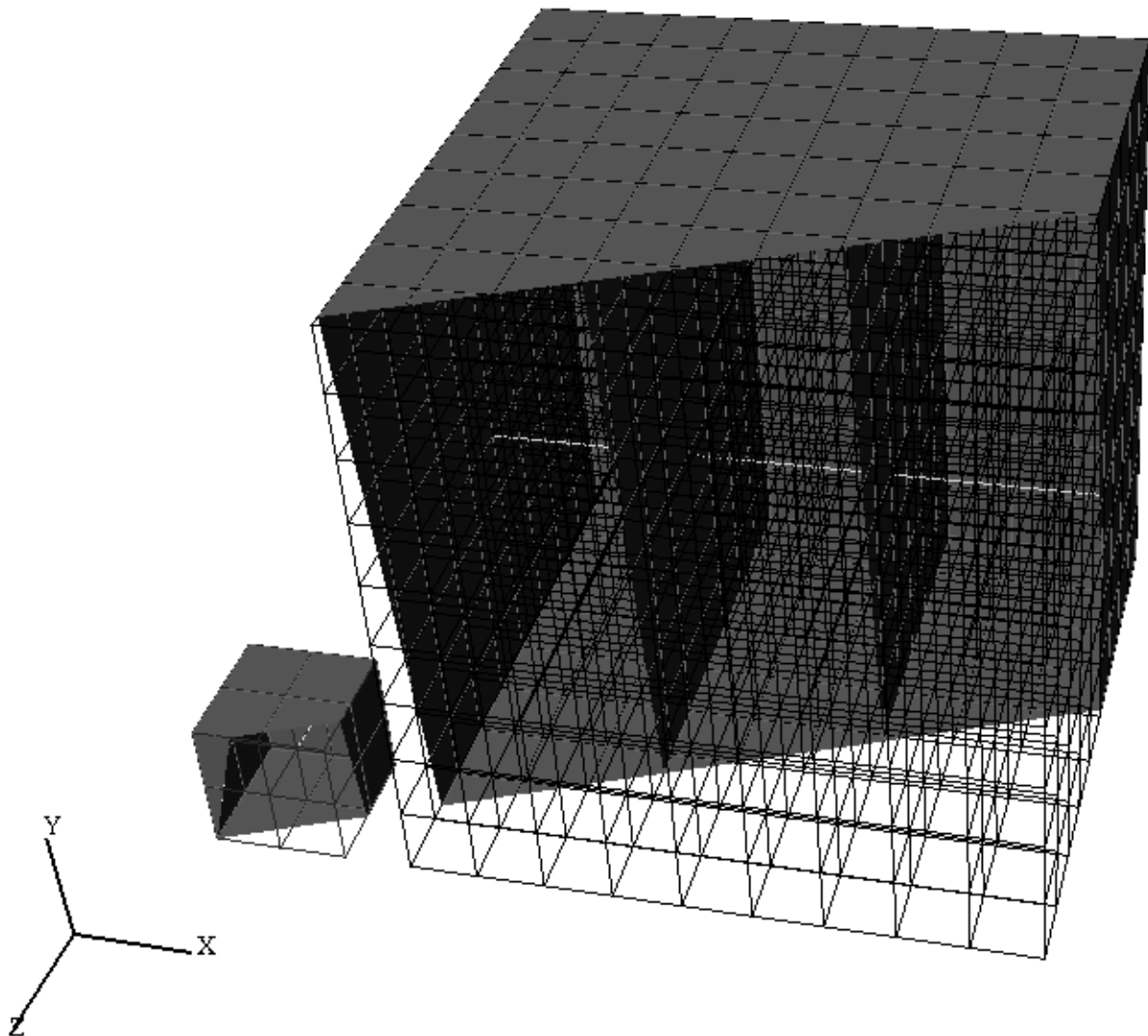

The file to accomplish this looks like:

```

ENSBND 1.00
front_back
top_bottom
x-planes
middle lines
BOUNDARIES
#bnd blk imin imax jmin jmax kmin kmax di dj dk n_ins
#--- --- ---- -
1 1 1 3 1 3 $ $
1 2 1 $ 1 $ 10 10
2 1 1 $ $ $ 1 $
2 2 1 10 10 10 1 10
1 1 1 3 1 3 1 1
1 2 1 $ 1 $ 1 1
2 1 1 3 1 1 1 $
2 2 1 $ 1 1 1 $
3 1 1 1 1 $ 1 $ 2 0 0 2
3 2 1 1 1 $ 1 $ 3 0 0 $
4 1 2 2 2 2 1 3
4 2 1 10 5 5 5 5

```

Interpreting the 12 boundary definition lines:

1 1 1 3 1 3 \$ \$  
defines a part of the boundary called front\_back, on block 1, where I=1 to 3, J=1 to 3, and K=3. Thus, the far K plane of block 1.

1 2 1 \$ 1 \$ 10 10  
defines another part of the front\_back boundary, on block 2, where I=1 to 10, J=1 to 10, and K = 10. Thus, the far K plane of block 2.

2 1 1 \$ \$ \$ 1 \$  
defines a part of the boundary called top\_bottom, on block 1, where I=1 to 3, J=3, and K=1 to 3. Thus, the far J plane of block 1.

2 2 1 10 10 10 1 10  
defines another part of the top\_bottom boundary, on block 2, where I=1 to 10, J=10, and K=1 to 10. Thus, the far J plane of block 2.

1 1 1 3 1 3 1 1  
defines another part of the front\_back boundary, on block 1, where I=1 to 3, J=1 to 3, and K=1. Thus, the near K plane of block 1.

1 2 1 \$ 1 \$ 1 1  
defines another part of the front\_back boundary, on block 2, where I=1 to 10, J=1 to 10, and K=1. Thus the near K plane of block 2.

2 1 1 3 1 1 1 \$  
defines another part of the top\_bottom boundary, on block 1, where I=1 to 3, J=1, and K=1 to 3. Thus, the near J plane of block 1.

2 2 1 \$ 1 1 1 \$  
defines another part of the top\_bottom boundary, on block 2, where I=1 to 10, J=1, and K=1 to 10. Thus, the near J plane of block 2.

3 1 1 1 1 \$ 1 \$ 2 0 0 2  
 defines a part of the boundary called x-planes, on block 1, where I=1, J=1 to 3, K=1 to 3, then again where I=3, J=1 to 3, and K=1 to 3. Thus, both the near and far I planes of block 1.

3 2 1 1 1 \$ 1 \$ 3 0 0 \$  
 defines another part of the x-planes boundary, on block 2, where I=1, J=1 to 10, and K=1 to 10, then again where I=4, J=1 to 10, and K=1 to 10, then again where I=7, J=1 to 10, and K=1 to 10, then again where I=10, J=1 to 10, and K=1 to 10. Thus, the I = 1, 4, 7, and 10 planes of block 2.

4 1 2 2 2 2 1 3  
 defines a part of the boundary called middle lines, on block 1, where I=2, J=2, and K=1 to 3. Thus, line through the middle of block 1 in the K direction.

4 2 1 10 5 5 5 5  
 defines another part of the middle lines boundary, on block 2, where I=1 to 10, J=5, and K=5. Thus a line through the middle of the block2 in the I direction.

Please note that the “\$” wildcard was used rather randomly in the example, simply to illustrate how and where it can be used.

The use of negative numbers for ijk planes is indicated below - again rather randomly for demonstration purposes. This file will actually produce the same result as the file above.

```

ENSBND 1.00
front_back
top_bottom
x-planes
middle lines
BOUNDARIES
#bnd blk imin imax jmin jmax kmin kmax di dj dk n_ins
#----
1 1 1 3 1 3 -1 -1
1 2 -3 -1 1 -1 10 10
2 1 1 -1 -1 -1 1 -1
2 2 1 10 10 10 1 10
1 1 1 3 1 3 1 1
1 2 1 -1 1 -1 1 1
2 1 1 3 1 1 1 -1
2 2 1 -1 1 1 1 -1
3 1 1 1 1 -1 1 -1 2 0 0 2
3 2 1 1 1 -1 1 -1 3 0 0 $
4 1 2 -2 -2 2 1 3
4 2 1 10 5 5 -6 -6

```

## 11.12 EnSight Particle Emitter File Format

This file can be used to specify the location of emitter points. It is most useful when the user has specific (and many) emit points to use for particle traces. Rather than type them all in one at a time as a cursor emitter, this file can be used.

Note the following:

1. The first two lines need to be exactly as shown.

```
Version 1.0
EnSight Particle Emitter File
```

2. #’s as the first character on a line, are comment lines. Comment lines can be used anywhere in the file after the first two mandatory lines.
3. Time lines contain the emitter release time (simulation time, NOT time step).
4. Emit lines contain the coordinates of an emitter. The emitter will be associated with the previously specified Time.

Sample File:

```
Version 1.0
EnSight Particle Emitter File
#
Time 0.249063
Emit 0.0669737 0.0134195 -0.013926
Emit 0.0669737 0.0131277 -0.0141079
Emit 0.0669737 0.0128642 -0.0143178
Emit 0.0669737 0.0155969 -0.0113572
Emit 0.0669737 0.0150344 -0.0122012
Emit 0.0669737 0.0146967 -0.0123587
#
Time 0.249113
Emit 0.0669737 0.0137097 -0.0136404
Emit 0.0669737 0.0134218 -0.0138284
Emit 0.0669737 0.0131628 -0.0140438
Emit 0.0669737 0.0158325 -0.0110264
Emit 0.0669737 0.0152879 -0.011882
Emit 0.0669737 0.0149536 -0.0120466
#
Time 0.249163
Emit 0.0669737 0.0139938 -0.0133488
Emit 0.0669737 0.01371 -0.0135428
Emit 0.0669737 0.0134555 -0.0137636
Emit 0.0669737 0.0160612 -0.0106906
Emit 0.0669737 0.0155347 -0.0115575
Emit 0.0669737 0.0152039 -0.0117291
#
Time 0.249213
Emit 0.0669737 0.0142718 -0.0130512
Emit 0.0669737 0.013992 -0.0132511
Emit 0.0669737 0.0137423 -0.0134773
Emit 0.0669737 0.0162827 -0.0103501
Emit 0.0669737 0.0157745 -0.0112279
Emit 0.0669737 0.0154475 -0.0114064
#
```

## 11.12 EnSight Particle Emitter File Format

```
Time 0.249263
Emit 0.0669737 0.0145433 -0.0127479
Emit 0.0669737 0.0142679 -0.0129536
Emit 0.0669737 0.014023 -0.013185
Emit 0.0669737 0.0164969 -0.0100051
Emit 0.0669737 0.0160074 -0.0108933
Emit 0.0669737 0.0156842 -0.0110787
```

# 12 Utility Programs

This chapter describes the utility programs that accompany EnSight. The Server utility programs are located in `$CEI_HOME/ensight80/server_utilities` and the Client utility programs are located in `$CEI_HOME/ensight80/client_utilities`.

*Utility programs are supplied on an “as is” basis and are unsupported. CEI will, however, try to assist in problem resolution.*

Each utility program is presented below and accompanied with a brief overview that describes the function of the utility.

**Section 12.1, EnSight5 Programs**

**Section 12.2, MPGS4 Programs**

**Section 12.3, Keyboard Macro Maker (macromake)**

**Section 12.4, Web Publisher/Project Management (scenario\_html\_publisher)**

## 12.1 EnSight5 Programs

### EnSight5 ASCII-to-Binary File Converter (*asciitobin5*)

The *asciitobin5* program runs on a Server host system to read ASCII EnSight 5.x files and convert them to C binary format files, which read much faster than ASCII files. Use this utility to facilitate the reading of large data files, especially when these files are read repeatedly.

### EnSight Data Translation Library

The EnSight interface library (“*libeio*”) provides a C API for reading and writing both the ASCII and the binary versions of the EnSight 5 format for geometry and results data. You can use it to simplify the process of writing translators or output modules for the EnSight format, as well as utilities that operate on the format.

Before using this library, you should be reasonably familiar with the EnSight 5 format described in section 2.5 of the EnSight User Manual.

The library (C source) can be found in the `$CEI_HOME/ensight80/translators/libeio` directory in your EnSight distribution. A translator for the unstructured “FAST” format that makes use of *libeio* can be found in `$CEI_HOME/ensight80/translators/unf`.

EnSight provides both ASCII and binary versions of its native data format. There are really only two reasons to use the ASCII format: if you need to actually look at the files or if you need to move a dataset to a computer system with a different binary format for numbers. Always use the binary format if possible. Not only does the I/O occur much faster, but the files will be smaller and will load into EnSight much faster as well.

You specify ASCII or binary output via the `SetFileType()` call. By default, output is set to binary.

#### Building the library

This library has been compiled and tested (to a limited extent) on the following systems:

- SGI IRIX 4.0.5
- SGI IRIX 5.3
- HPUX 9.0.5
- Solaris 2.3

1. Edit the Makefile for your system (as shipped, it is configured for IRIX).
2. To build the library, type “make”. If you are porting the library to a new platform or operating system release, you may have to make some minor modifications to the Makefile and/or the source code.
3. To build executables that call routines in the library either include “`../libeio.a`” in your final link command or add the “`-leio`” option to the link command (which assumes the linker knows where to find the library).

#### Warnings

The following caveats apply to this initial release of *libeio*:

1. Error checking is a little skimpy at this point. It needs to be improved, especially for the input routines. In general, the input routines assume that a correctly formatted EnSight file is being read.
2. The input routines will only handle C binary files – not Fortran!



**Hints**

When reading EnSight format files into EnSight, you have the option of whether to load all parts, all but the first part, or the first part only. You can sometimes take advantage of this and save loading time as well as memory on the EnSight Client if you can load all but the first part. In many 3D applications (particularly CFD) one part can contain all 3D elements of the computational domain. Other parts typically contain boundary or shell elements. Since you don't really need to look at a graphical representation of the computational domain (if you have a boundary representation), you can avoid its initial load and display on the Client by having the 3D computational domain part as the first part in the EnSight geometry file and using the "all but the first part" load option in EnSight.

**Output Routines**

```
void SetFileType(int type)
```

`SetFileType()` sets the output type for subsequent calls to I/O routines. The type parameter is either ASCII or BINARY (as defined in `eio.h`). NOTE: the `ReadGeometry()` and `ReadParticleGeometry()` input routines will reset the type based on the type of the file last read.

The output routines are divided into two types: those that operate on the EnSight-based data structures (defined in `eio.h`) and those that accept raw arrays for output. The first four routines operate on the defined data structures:

```
int WriteGeometry(char *filename, Geometry *geo)
int WriteParticleGeometry(char *filename, ParticleGeometry *geo)
int WriteScalar(char *filename, Scalar *scl)
int WriteVector(char *filename, Vector *vec)
```

These routines take a completed structure for the corresponding item and write it to the file specified by "filename". See the definitions for `Geometry`, `ParticleGeometry`, `Scalar`, and `Vector` in `eio.h` for more info.

The remaining routines accept raw arrays for output.

```
int WriteGeoHeader(char *filename, char *des1, char *des2, int nodeid, int elemid)
```

`WriteGeoHeader()` begins the process of geometry file output. The `des1` and `des2` parameters are description lines for the model. The `nodeid` and `elemid` parameters should be set to one of the defined constants (e.g. `ID_OFF` or `ID_ASSIGN`) in `eio.h`. `WriteGeoHeader()` should be followed by `WriteGeoCoords()`.

```
int WriteParticleGeoHeader(char *filename, char *des)
```

`WriteParticleGeoHeader()` begins the process of particle geometry file output. Although particle files have two description lines in the header, the second one is ALWAYS "particle coordinates". `WriteParticleGeoHeader()` should be followed by a call to `WriteGeoCoords()`. Note that particle files must always have coordinate IDs!

```
void WriteGeoCoords(int partcoords, int num, int *id, float *coords)
```

`WriteGeoCoords()` appends coordinates to the geometry file opened by the previous call to `WriteGeoHeader()`. If the `nodeid` parameter to `WriteGeoHeader()` was either `ID_GIVEN` or `ID_IGNORE` then the `id` pointer must point to a list of `num` integers. The `coords` parameter must point to a list of  $3 * \text{num}$  floats in order `X1, Y1, Z1, X2, Y2, Z2, ..., Xn, Yn, Zn`. `WriteGeoCoords()` should be followed by a call to

`WriteGeoPart()`.

`WriteGeoCoords()` is also used to output particle coordinates (e.g. following a call to `WriteParticleGeoHeader()`). Be sure to set the `partcoords` parameter to `True` when writing particle coordinates!

```
void WriteGeoPart(char *line)
```

`WriteGeoPart()` begins the process of part definition. A part header will be output to the file opened in the previous call to `WriteGeoHeader()`. `WriteGeoPart()` must be followed by one or more calls to `WriteGeoElem()`.

```
void WriteGeoElem(int elemtype, int num, int *id, int *nd)
```

`WriteGeoElem()` outputs a set of elements of the same type to the current part (as defined by the most recent call to `WriteGeoPart()`). The `elemtype` parameter must be one of the types defined in `eio.h` (e.g. `HEXA8` or `QUAD4`). `num` is the number of elements to output. If the `elemid` parameter to `WriteGeoHeader()` was either `ID_GIVEN` or `ID_IGNORE` then the `id` pointer must point to a list of `num` integers containing element ID numbers. The `nd` pointer points to a list of `N*num` integers, where `N` is the number of nodes in the particular type of element (e.g. 8 for a `HEXA8` type). Node ordering is defined section 3.8.

You can call `WriteGeoElem()` as many times as you like between calls to `WriteGeoPart()` to define different element sets belonging to a particular part.

```
int WriteRawScalar(char *filename, char *descrip, char *varname, int num, float
*data)
```

`WriteRawScalar()` writes a scalar variable to the file named `filename`. The `varname` parameter will be saved and used in a subsequent call to `WriteResults()`. `num` is the number of values. `data` is a pointer to `num` floating point values. The values must be ordered the same as the coordinates in the corresponding geometry file.

```
int WriteRawVector(char *filename, char *descrip, char *varname, int num, float
*data)
```

`WriteRawVector()` writes a vector variable to the file named `filename`. The `varname` parameter will be saved and used in a subsequent call to `WriteResults()`. `num` is the number of values. `data` is a pointer to `3*num` floating point values. The values must be ordered the same as the coordinates in the corresponding geometry file.

```
int WriteResults(char *filename, Result *rp)
```

`WriteResults()` will output an EnSight “results” file describing a complete geometry plus results dataset. `rp` points to a `Result` structure (defined in `eio.h`) containing the desired information.

## Input Routines

The input routines read a particular type of EnSight file and load the contents to a structure defined in `eio.h`.

```
Geometry *ReadGeometry(char *filename)
```

The `ReadGeometry()` routine reads a complete geometry file and returns the various components in the `Geometry` structure. It returns `NULL` on error. `ReadGeometry()` will automatically determine if the file is ASCII or binary and will set the type for subsequent reads.

```
ParticleGeometry *ReadParticleGeometry(char *filename)
```

The `ReadParticleGeometry()` routine reads a complete particle geometry file and returns the various components in the `ParticleGeometry` structure. It returns `NULL` on error. `ReadParticleGeometry()` will automatically determine if the file is ASCII or binary and will set the type for subsequent reads.

```
Scalar *ReadScalar(char *filename, int num)
```

`ReadScalar()` will read a scalar file and return a pointer to a `Scalar` structure (or `NULL` on error). `num` must equal the number of values to read. `ReadScalar()` will assume the file type (ASCII or binary) is the same as that determined in `ReadGeometry()` (but you can override with a call to `SetFileType()`).

```
Vector *ReadVector(char *filename, int num)
```

`ReadVector()` will read a vector file and return a pointer to a `Vector` structure (or `NULL` on error). `num` must equal the number of values (nodes) to read, *i.e.* there should be  $3 * \text{num}$  floats in the file. `ReadVector()` will assume the file type (ASCII or binary) is the same as that determined in `ReadGeometry()` (but you can override with a call to `SetFileType()`).

```
Result *ReadResults(char *filename)
```

`ReadResults()` will read an EnSight results file and return the information in an allocated `Result` structure.

## 12.2 MPGS4 Programs

### MPGS4 ASCII-to-Binary File Converter (*asciitobin4*)

The *asciitobin4* program runs on a Server host system to read ASCII MPGS 4 data files and convert them to binary files, which read much faster than ASCII files. Use this utility to facilitate the reading of large data files, especially when these files are read repeatedly. See also *asciitobin5* above.

### MPGS4 File Concatenater-Transformer

The programs under the `cat_transform4` directory run on a Server host system and perform various concatenation and transformation operations on MPGS 4 dataset files. For example, the following two utility programs are included in this directory:

*cat\_mpgs* concatenates two or more MPGS 4 data files.  
*tform\_mpgs* translates and rotates MPGS 4 data files.

### MPGS4 Geometry File Debug Filter (*filter4*)

The *filter4* program runs on a Server host system to read an MPGS 4 geometry file (either ASCII or binary). After reading the file, you can perform queries to aid in debugging connectivity information. You are prompted for a solid number, after which *filter4* will print all known information for that solid. If *filter4* cannot read the data, there is probably a problem with the data formatting.

### MPGS4 Min-Max Scalar Finder (*minmaxs4*)

The *minmaxs4* program runs on a Server host system to scan a set of MPGS 4 (multiple time step) *scalar* files, and print the minimum and maximum scalar information. See also *minmaxv4* below.

### MPGS4 Min-Max Vector Finder (*minmaxv4*)

The *minmaxv4* program runs on a Server host system to scan a set of MPGS 4 (multiple time step) *vector* files, and print the minimum and maximum vector information. See also *minmaxs4* above.

### MPGS4 Structured Mesh Generator (*structmesh4*)

The *structmesh4* program runs on a Server host system, and creates an MPGS 4 geometry file that contains a 3D (cube) structured mesh.

## 12.3 Keyboard Macro Maker (macromake)

The *macromake* program runs on the Client host system and assigns a keyboard key to a prerecorded EnSight command file (or files). The macro key code and command file name(s) are updated in the `macro.define` file, which stores your macro definitions.

The command file(s) can contain any sequence of valid EnSight commands that will execute each time the macro key is pressed while running EnSight. You can assign one command file to a *repeatable* macro key—the contents of the command file plays as long as the macro key is depressed. Macros are currently limited to single key definitions.

See: [How To Define and Use Macros](#).

## 12.4 Web Publisher/Project Management (scenario\_html\_publisher)

The *scenario\_html\_publisher* program runs on the client host system. It provides a way to generate HTML files that describe EnSight scenario projects and can be used with a web browser to ease access to the information contained there. The publisher program will create an HTML file with links to project description, EnLiten scenario, image, EnVideo movie, MPEG movie, and EnSight restart files. The web browser reads the main HTML file for the project directory or set of directories. The user can then select the links to view further information contained throughout the project which might start up helper applications EnVideo, EnLiten, and EnSight. In the case of EnSight the context file will be read to restore EnSight to the point that you saved the scenario project. This arrangement does not require you to have a web server handle the pages. The user can have their own little area that can be accessed with the web browser by providing it with a URL of `file:/home/users/joe/projects/shuttle1.htm`. The user, of course, would provide the true path to the starting HTML file produced by the *scenario\_html\_publisher* program. The user can also collaborate with their colleagues by pointing them to this `file:` URL if they have access to the same directory or they can work with their local Web Master to put copy the directory structure into the location served by a local web server. This area could then be accessed by colleagues around the world with their browser. The area may be a password protected area or it could be wide open to the world to view the exciting images, movies, and information that it contains. Work with your Web Master to protect the area as you see fit. To use the publisher please read the header of the *scenario\_html\_publisher* script. It can be found in the installation directory for EnSight under `scenario_tools/unix`. The *scenario\_html\_publisher* program is currently only available for Unix but the pages that it produces are readable by any web browser on any type of computer.

# 13 Parallel Rendering and Virtual Reality

EnSight Gold 8.0 supports general parallel rendering for increased performance, increased display resolution, and arbitrary screen orientations. Combined with support for 6 DOF (degree-of-freedom) input devices, EnSight Gold provides an immersive virtual reality interface. This chapter describes the configuration file format and command-line parameters required for parallel rendering and 6D input. Using hardware accelerated rendering, parallel rendering is supported on SGI Irix 6.5, Sun Solaris 8, and HP-UX 11.0. Using software rendering (`ensight8 -x`) these features are supported on all Unix/Linux platforms. Six DOF input is supported on all Unix/Linux platforms, with pre-compiled tracked support for Irix, Solaris, and Linux (x86).

In order to make use of parallel rendering with EnSight, the user must create a configuration file. This file is specified on the command line using the argument `-dconfig <file>`. If `<file>` is not a fully-qualified path EnSight will search for the file in the following directories:

1. `~/.ensight8/dconfig/`
2. `$CEI_HOME/ensight80/site_preferences/dconfig/`

These options allow for user-level and site-level configurations, respectively.

There are two logical displays which can be configured in EnSight. The *GUI display* is always active, and consists of the main rendering window embedded in the user-interface. The *detached display* is external to the user-interface, and may consist of 1-36 regions configured to form a large continuous display. The configuration file contains information about both the GUI display and the detached display, as well as tracking calibration information and options for using 6D input devices. The remaining sections will address each of the capabilities related to parallel rendering and VR. The sample configurations described in this chapter can be found in the directory `$CEI_HOME/ensight80/src/input/dconfig`. There are also examples of ‘simulated’ configuration files, which allow you to simulate display to multiple graphics pipes on a single display.

## CONFIGURATION FILE FORMAT

### MULTI-PIPE PARALLEL RENDERING

### DISPLAY WALLS

### IMMERSIVE DISPLAYS

### TRACKING

### ANNOTATIONS

### STEREO DISPLAY

### TIPS

## CONFIGURATION FILE FORMAT

Configuration files are entirely text-based beginning with the line:

```
PRsD 2.0
# after the first line, anything following a '#' is a comment
```

The remainder of the file consists of one or more sections describing the displays and options. In describing the format of the file, portions which are optional will be surrounded by [].

## MULTI-PIPE PARALLEL RENDERING

The default mode of EnSight uses only a single graphics pipe for rendering to the GUI display. When run on a multi-pipe Unix/Linux machine, EnSight can be configured to use the additional pipes to accelerate the display through parallel rendering. The format of the configuration for the GUI display is as follows:

```
guidisplay
  worker <p1>
  worker <p2>
  ...
  worker <pn>
```

where:

<p<sub>i</sub>> = an X display (i.e. localhost:0.2)

### Example 1:

```
PRsD 2.0
# This configuration uses 4 graphics pipes to
# accelerate rendering
guidisplay
  worker :0.1
  worker :0.2
  worker :0.3
```

In the example above, there is one X server (:0) which manages four graphics pipes. Note that the configuration file does not include the pipe to which the EnSight GUI is displayed. The GUI is always displayed on the pipe indicated by the `$DISPLAY` environment variable, and it is not necessary to specify this screen in the configuration file. Parallel software rendering is available on all Unix/Linux platforms with the `-X` option. The same configuration file format is used in this case, although the displays themselves are not actually opened.

There are two convenience mechanisms for common configurations. When running EnSight on an X server with multiple screens, it is possible to configure EnSight to use all of the pipes for accelerating the GUI display using the command-line option: `-dconfig mpipe`. This will detect how many pipes are available and configure them appropriately. This auto-configuration option will not be able to configure multiple screens which belong to multiple X servers (i.e. :0.0, :1.0, :2.0).



When using software rendering, if the named file is not found and “<file>” is a number, this number will be interpreted as the number of parallel rendering workers. For example:

```
ensight8 -X -batch -dconfig 3 -p <cmdfile>
```

will run a batch session with a total of 4 threads performing parallel rendering.

## DISPLAY WALLS

Another type of parallel rendering available in EnSight allows for the use of multiple graphics pipes to create large, flat tiled displays. Commonly referred to as display walls, this is the first example of a “*detached display*” supported by EnSight. Detached displays are supported on all platforms, including Windows. The advantage of a display wall configuration is that the file specification is easy to create. The disadvantage is that display walls cannot be used for tracking and 6d input. In order to use tracking, it will be necessary to use the more general immersive configuration format described later.

The specification for a display wall consists of:

```
wallresolution
  <x-res> <y-res>
numpipes
  <num>
pipe
  xserver <p1>
  resolution <x-res> <y-res>
  wallorigin <wall-x> <wall-y>
  [ xorigin <xo> <yo> ]
  [ lefteye
    or
    righteye
  ]
  [ worker <p2>
    ...
    worker <pn> ]
[ repeat 'pipe' section (num-1) more times ]
```

The `wallresolution` section gives the total pixel resolution of the display wall. The `numpipes` parameter specifies how many separate regions will be configured. For each region, there will be a `pipe` section that describes the size (resolution) and position (`wallorigin`) of the region within the global display. The `xserver` parameter specifies the X display (i.e. :0.1). This parameter is ignored on Windows, because there is only a single “screen” regardless of the number of graphics cards or video outputs. The `xorigin` is an optional parameter to specify the origin of the window on the given pipe (default (0,0)). Note that `xorigin` is a position relative to the origin of a given xserver, while `wallorigin` is a position relative to the origin of the global display. Changing `wallorigin` will change the region of the wall that is visible in a given window, while changes to `xorigin` simply move the window on the screen without changing the contents. Example 5a will demonstrate a situation

when the use of `xorigin` is useful. The `lefteye/righteye` optional designation can be used for passive stereo displays, in which separate graphics pipes render the left and right images. Note that each pipe in a detached display can have one or more `worker` pipes configured to accelerate the rendering, just as described in the previous section.

### Example 2

In this example there is one X server with five graphics pipes. The GUI is displayed on pipe `:0.0`, with the other four pipes used for the detached display. Four projectors are configured in a 2x2 array to form a large continuous wall as illustrated:

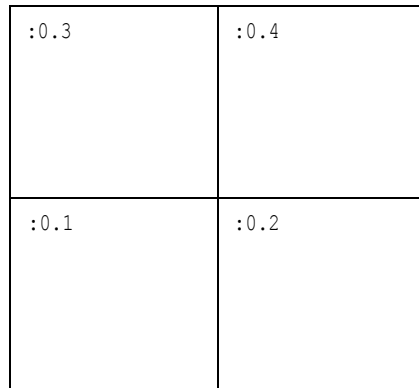

```
PRsD 2.0
#
# conference room display wall
#
wallresolution
    2560 2048
numpipes
    4
pipe # lower-left
    xserver :0.1
    resolution 1280 1024
    wallorigin 0 0
pipe # lower-right
    xserver :0.2
    resolution 1280 1024
    wallorigin 1280 0
pipe # upper-left
    xserver :0.3
    resolution 1280 1024
    wallorigin 0 1024
pipe # upper-right
    xserver :0.4
    resolution 1280 1024
    wallorigin 1280 1024
```

### Example 3

It is not uncommon for displays walls to use overlapping images with *edge-blending* to smooth the otherwise sharp transition between projector images. The edge-blending is performed by the projectors directly. This is easily configured as a detached display by specifying pipes with overlapping pixel regions. Consider an example of two pipes at 1280x1024 resolution each, with an overlap of 128 pixels.

```
PRSD 2.0
#
# edge-blending example
#
wallresolution
  2432 1024
numpipes
  2
pipe # left
  xserver :0.1
  resolution 1280 1024
  wallorigin 0 0
pipe # right
  xserver :0.2
  resolution 1280 1024
  wallorigin 1024 0
```

Note that in this case the total resolution of the wall in the x direction is decreased by the amount of overlap.

### Example 4

Passive stereo displays achieve stereo by projecting overlapping polarized images from multiple projectors. This can be achieved using detached displays with a distinct rendering region for each screen and eye. Consider for this example a single screen with two projectors. For illustration purposes we will assume that we have five graphics pipes. One pipe (:0.0) renders the GUI and is not listed. Two pipes use parallel rendering to render the left eye image, and two pipes render the right eye image.

```
PRSD 2.0
#
# passive stereo display
#
wallresolution
  1280 1024
numpipes
  2
pipe # left-eye
  xserver :0.1
  resolution 1280 1024
  wallorigin 0 0
  lefteye
```

```

    worker :0.2
pipe # right-eye
    xserver :0.3
    resolution 1280 1024
    wallorigin 0 0
    righteye
    worker :0.4

```

Note that the `lefteye/righteye` parameters are NOT necessary when using traditional quad-buffered stereo to drive the projectors. Some systems have a signal splitter which takes the frame-sequential stereo signal and generates separate signals for left and right eye. In this case a conventional configuration file without the “eye” designations will work fine. Passive stereo displays are always in stereo mode.

## IMMERSIVE DISPLAYS

True immersive display requires more information than is present in the display wall configuration files previously described. The key factors are that (1) immersive displays are often not flat and (2) the rendered images must be co-registered with the coordinates of a 6d input tracking system.

The basic syntax of the immersive display configuration is going to look very similar to the display wall format:

```

numpipes
    <num>
pipe
    xserver <p1>
    resolution <x-res> <y-res>
    [ xorigin <x0> <y0> ]
    [ bottomleft <x> <y> <z>
      bottomright <x> <y> <z>
      topleft <x> <y> <z>
    ]
    [ lefteye
      or
      righteye
    ]
    [ worker <p2>
      ...
      worker <pn> ]
    [ repeat 'pipe' section (num-1) more times ]

```

The important difference is that the position of the screen is measured in 3d physical coordinates, rather than 2d pixel coordinates. Note that all 3d coordinates given in the file are unit-less, but they must be consistent and in the same frame of reference, which is referred to as "display coordinate space".

The designations bottom/top refer to the minimum Y/maximum Y of the region, and left/right refer to the minimum X/maximum X of the region. In some cases 'bottom' may be near the ceiling, and 'top' may be near the floor, such as when a projector is mounted in an inverted position.

When determining the proper coordinates to use it is invaluable to sketch out the display environment, label the corners of each screen, and mark the location of the origin of the coordinate system. When using 6D input, the display coordinate system and the tracking coordinate system must be the same.

### Example 5

For the purpose of illustration consider the following example. Two projectors are pointed at screens which form a right angle, as illustrated below. The projected images are 10 feet wide by 7.5 feet high. The tracking system is calibrated in units of feet with the origin on the floor in the middle of the room.

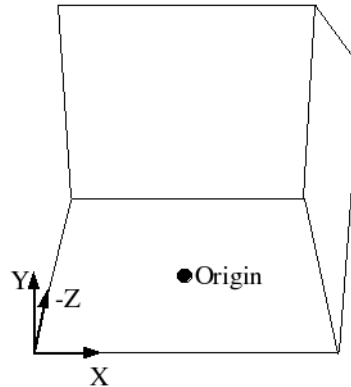

```

PRsD 2.0
numpipes
  2
pipe
  xserver :0.2
  resolution 1024 768
  bottomleft -5 0.0 -5
  bottomright 5 0.0 -5
  topleft -5 7.5 -5
pipe
  xserver :0.1
  resolution 1024 768
  bottomleft 5 7.5 -5
  bottomright 5 7.5 5
  topleft 5 7.5 -5

```

Without head-tracking, this example is not yet very useful. The default position of the viewer is at (0,0,0), which is on the floor in the chosen coordinate system. There is an optional `view` section that can be inserted before the `numpipes` keyword of the configuration file to change these defaults:

```

view
  [ origin <x> <y> <z> ]
  [ zaxis <nx> <ny> <nz> ]
  [ yaxis <nx> <ny> <nz> ]
  [ center <x> <y> <z> ]
  [ scale <factor> ]
  [ eyesep <d> ]

```

The `origin` specifies the position of the viewer, and is only used if head-tracking has not been enabled. The `zaxis` and `yaxis` are unit vectors that allow the specification of a default orientation for objects placed in the scene. The default values are (0,0,-1) for `zaxis` and (0,1,0) for `yaxis`. From the `origin` vantage point, it is useful to think of `zaxis` as the direction that the viewer is looking and `yaxis` as the 'up' direction.

The `center` and `scale` parameters allow you to position and size the scene for your display. If these parameters are not given, EnSight will compute a bounding box from the 3d coordinates given in the `bottomleft`, `bottomright`, and `topleft` parameters for the screens. The default center will be at the center of this box and the default scale will be computed so that your EnSight scene will fill the 3d space. Specifying a scale factor of 1.0 may be useful if your display coordinates were designed to coincide with your model coordinates. This will allow you to view your models life-sized.

The `eyesep` parameter allows an exact setting of the stereo separation between the eyes.

### Example 5a

Extending our example, we can position the viewer at the opposite corner of the room at a height of 5.75 feet:

```
PRsD 2.0
view
  origin -5 5.75 5
numpipes
  2
pipe
  xserver :0.2
  resolution 1024 768
  bottomleft -5 0.0 -5
  bottomright 5 0.0 -5
  topleft -5 7.5 -5
pipe
  xserver :0.1
  resolution 1024 768
  bottomleft 5 0.0 -5
  bottomright 5 0.0 5
  topleft 5 7.5 -5
```

### Example 5a-sim

It is relatively straightforward to test large displays and VR environments on a smaller system with a different number of graphics pipes. This can be accomplished by creating a configuration file that maps the pipes to smaller regions on a single monitor. As an example we will take the immersive configuration from Example 5a and modify it to run on a single display, with the modified regions shown in bold text.

```
PRsD 2.0
view
```

```

    origin -5 5.75 5
numpipes
    2
pipe
    xserver :0.0
    resolution 320 240
    bottomleft -5 0.0 -5
    bottomright 5 0.0 -5
    topleft -5 7.5 -5
pipe
    xserver :0.0
    xorigin 320 0
    resolution 320 240
    bottomleft 5 0.0 -5
    bottomright 5 0.0 5
    topleft 5 7.5 -5

```

Note that this method makes use of the `xorigin` parameter so that the resulting windows do not overlap. The default value for `xorigin` is (0,0) for each pipe. In a similar manner it is also possible to simulate large display walls on a single pipe.

## TRACKING

EnSight supports tracking and input with 6 DOF devices through a defined API. Pre-built libraries are provided to interface with trackd ((C) VRCO, Inc., [www.vrco.com](http://www.vrco.com)) on SGI, Sun, and Linux(x86), or the user may write a custom interface to other devices or libraries. The tracking library is specified with the `CEI_INPUT` environment variable. To select trackd, use:

```
setenv CEI_INPUT trackd (for csh or equivalent users)
```

The value of `CEI_INPUT` can either be a fully-qualified path and filename or simply the name of the driver, in which case EnSight will load the library `libuserd_input.so` from directory:

```
$CEI_HOME/apex10/machines/$CEI_ARCH/udi/$CEI_INPUT/
```

For the trackd interface you will also need to set:

```
CEI_TRACKER_KEY <num>
CEI_CONTROLLER_KEY <num>
```

in order to specify the shared-memory keys for the input library to interact with trackd. You should be able to find these values in your `trackd.conf` configuration file. For information on the API which allows you to interface to other tracking libraries or devices, please see the `README` file in `$CEI_HOME/ensight80/src/udi`.

With the environment variables set, you are ready to activate tracking. There are two parts to this. First, trackd operates as a daemon that is run independent of EnSight. If your input interface includes a separate program, you can run it at this time. For trackd users, it is often useful during configuration to invoke trackd with

the `-status` option, so that you can see the information on your input devices. Once any external programs are started, you can enable tracking in EnSight. From the 'Preferences->User Defined Input' menu, there is a toggle button which turns tracking on and off.

The `trackd` driver shipped with EnSight also has a debug mode that can be activated as follows:

```
setenv CEI_TRACKD_DEBUG 1
```

This is similar to the `trackd -status` option, but it reports the input as seen by the EnSight `trackd` interface.

Once the EnSight client has been correctly interfaced to a tracking system you can add a section to the configuration file in order to calibrate the tracking with the display frame and customize the behavior of various interactions. The syntax for the section is:

```
tracker
  [ headtracker <i> ]
  [ cursortracker <i> ]
  [ selectbutton <i> ]
  [ rotatebutton <i> ]
  [ transbutton <i> ]
  [ zoombutton <i> ]
  [ xformbutton <i> ]
  [ transxval <i> ]
  [ transyval <i> ]
  [ transzval <i> ]
```

The `headtracker` and `cursortracker` parameters allow you to specify which tracking device is tracking head position and which is tracking the controller. At this time only two devices can be tracked by EnSight – one for the head position and one for the position of the controller. All button/valuator input is interpreted as having come from the controller. Note that the EnSight API for input devices uses 0-based indices for trackers, buttons, and valuator. `Trackd` uses 1-based indices, and other libraries may differ as well.

The remaining options allow you to customize the behavior of buttons and valuator on the 6D input device. The input device can be used for:

1. Selecting items from the 3D GUI, which includes the heads-up macro (HUM) panel, the part list, variable list, and value slider.
2. Performing transformations on the geometry in the scene.
3. Manipulating the cursor, line, plane, and quadric tools.



The input device has a local coordinate system which is relevant for some forms of 6D interaction:



The default mode defines button 0 as the select button. When the 3D GUI is visible, you can point at the 3D buttons and the item that you are pointing at will be displayed in a highlight color. When you press the select button you will activate the current selection. For the HUM panel, this means that you will activate the macro that is defined for the selected button. You will find example macro files and additional instructions in `$CEI_HOME/ensight80/src/udi/README`. Clicking on an item in the part list will select or unselect the item in the list. Combined with macros in the HUM, this will allow you to modify visibility or other attributes on a part or collection of parts. If there are many parts in the part list, you can also select the scrollbar and move the controller up and down to scroll through the list. Similarly, the part-value slider can be used to modify part attributes for certain part types. For isosurfaces you can select the part slider and move left to right to change the isovalue. When no parts are selected, the part-value slider can be used to modify the time in a transient simulation.

The `rotatebutton`, `transbutton`, and `zoombutton` allow you to perform the selected transformations using gestures with the 6d input device. The `xformbutton` allows you to link a button to the current transformation mode, similar to the mouse button configurations for the main GUI interactions. You may want to add buttons on the heads-up-macro (HUM) panel to switch between modes. This is useful for 6D input devices with a smaller number of buttons. Note that it is possible (and encouraged) to re-use the `selectbutton` for a transformation. The `selectbutton` is only used when you are pointing at a heads-up menu. When you are not pointing at a menu, the same button could be used as the `xformbutton`, for example.

All 6d transformations have a 'sensitivity' which can be set to control the speed at which the transformation occurs. These values can be set from the 'Edit->Preferences->User Defined Input' dialog. There are also two forms of rotation available. In 'Mixed Mode', the 6d device acts similar to a mouse for rotation. Once you click the `rotatebutton`, your movement is tracked in the X-Y plane of the input device. Your translation in this space is mapped to a rotation in the 3D space. In 'Direct Mode' it is the orientation of the device, rather than the position of the device, which controls the rotation.

The `transxval`, `transyval`, and `transzval` parameters configure the valuator to allow for translation of the scene by pressing the valuator in a given direction. The 'x', 'y', and 'z' designations refer to a local coordinate system which

is fixed to the controller input device. As you hold the device in your hand, positive x is to the right, positive y is up, and positive z is toward the viewer. This local coordinate system depends on the orientation of the tracking device attached to the input device. It may be necessary to align the tracking device properly or modify the tracked (or other tracking library) configuration to achieve the proper orientation.

### Example 6

For the most basic configuration with head-tracking and a 6d input device, there are only three lines added to Example 5 to create the `tracking` section:

```
PRsD 2.0
numpipes
  2
view
  origin -5 5.75 5
tracker
  headtracker 0
  cursortracker 1
pipe
  xserver :0.2
  resolution 1024 768
  bottomleft -5 0.0 -5
  bottomright 5 0.0 -5
  topleft -5 7.5 -5
pipe
  xserver :0.1
  resolution 1024 768
  bottomleft 5 0.0 -5
  bottomright 5 0.0 5
  topleft 5 7.5 -5
```

### Example 6a

There are many different input devices available, and some have additional buttons and valuators that can be used for navigation and selection in immersive environments. In this example the configuration file is extended to use different buttons for rotation, translation, zoom, and selection. We also configure a ‘thumbwheel’ input to provide translation in the X-Z plane.

```
PRsD 2.0
numpipes
  2
view
  origin -5 5.75 5
tracker
  headtracker 0
  cursortracker 1
  selectbutton 4
  rotatebutton 0
  transbutton 1
  zoombutton 2
```

```

    xtransval 0
    ztransval 1
pipe
  xserver :0.2
  resolution 1024 768
  bottomleft -5 0.0 -5
  bottomright 5 0.0 -5
  topleft -5 7.5 -5
pipe
  xserver :0.1
  resolution 1024 768
  bottomleft 5 0.0 -5
  bottomright 5 0.0 5
  topleft 5 7.5 -5

```

## ANNOTATIONS

Annotations in EnSight include the heads-up macro panel, text, lines, logos, legends, and plots. In the GUI display these items appear as an overlay which is fixed in screen space. In an immersive display environment it is useful to be able to specify the locations of these objects. In EnSight 8.0, these items continue to occupy a plane in the 3D world. By default, this plane will coincide with the first pipe in the configuration file. The user may choose to specify the position and orientation of this plane with the following addition to the configuration file:

```

annot
  [ pipe <n> ]
    OR
  [
    center <x> <y> <z>
    zaxis <x> <y> <z>
    yaxis <x> <y> <z>
    xscale <float>
    yscale <float>
  ]

```

### Example 7

To continue with Example 6, suppose that the user would prefer for the annotations to appear on the right wall instead of the left wall. The following configuration file defines an annot section with the appropriate parameters to do this:

```

PRSD 2.0
numpipes
  2
view
  origin -5 5.75 5
tracker
  headtracker 0
  cursortracker 1
  selectbutton 4
  rotatebutton 0

```

```

    transbutton 1
    zoombutton 2
    xtransval 0
    xtransval 1
annot
    pipe 1
pipe
    xserver :0.2
    resolution 1024 768
    bottomleft -5 0.0 -5
    bottomright 5 0.0 -5
    topleft -5 7.5 -5
pipe
    xserver :0.1
    resolution 1024 768
    bottomleft 5 0.0 -5
    bottomright 5 0.0 5
    topleft 5 7.5 -5

```

Fixing the annotations to a pipe is merely provided as a convenience. Internally this is identical to using the explicit form:

```

annot
    center 5 3.75 0
    zaxis 1 0 0
    yaxis 0 1 0
    xscale 10
    yscale 7.5

```

## STEREO DISPLAY

When using a detached display (either a wall or an immersive configuration) the created windows will be monoscopic by default. If you want the display to be initialized in stereo, you can simply add the keyword to the configuration file between any of the other sections.

```
stereo
```

This keyword is not necessary for passive stereo displays, which are always in stereo.

## TIPS

1. Use the `-bbox` command-line option when using a detached display. This will cause EnSight to draw only bounding boxes in the GUI window, which will improve performance.
2. Make sure that the displays that are in your configuration files are valid. An X display identifier looks like: `<host>:<server>.<screen>`. If you have constructed a valid X display you should be able to set the `$DISPLAY` environment variable with the given string and run `xterm` or another X11 application.
3. Tracking is the most difficult part of configuring a system. Make sure that

you are confident in the display configuration before you activate tracking. It may be useful to manually position the view origin in several different locations in order to verify that the display coordinate system is as you expected. In the examples installed from your CD-ROM example 5 is extended with several different view origins to demonstrate this technique.



# Index

## Symbols

+ button 3-2

## A

ABAQUS ODB 2-18

ABAQUS\_FIL reader 2-17

animate

function key F4

saving animation 8-49

animation

clip

saving animation 7-44

flipbook

advantages 7-7

created data 7-7

definition 1-11, 7-6

disadvantages 7-7

graphic image pages 7-6

graphic object pages 7-6

linear load 7-7

mode shapes 7-7

saving animation 7-9

transient data 7-7

troubleshooting 7-11

Flipbook Animation Editor 7-8

Flipbook Animation Icon 7-8

isosurface

saving animation 7-39

keyframe

definition 1-11, 7-12

Keyframe Animation Editor 7-14

Quick Animations dialog 7-18

Recorder dialog 7-19

Run From/To dialog 7-16

save animation 7-19

Transient data dialog 7-17

troubleshooting 7-20

Viewing Window dialog 7-16

line clip animation delta 7-49

particle trace 7-70

saving animation 7-74

troubleshooting 7-72

plane clip animation delta 7-52

quadric clip animation delta 7-55

revolution clip animation delta 7-56

saving 7-3, 7-9, 7-39, 7-44, 7-74

saving and restoring frames 2-79

saving animation 8-49

solution time streaming 1-11, 7-3

transient

saving animation 7-3

Annot Mode 8-12

annotation

delete text, line or logo 8-17

logo importing 8-15

Parallel Rendering 13-13

preferences 6-7

text creation 8-13, 8-15

Virtual Reality 13-13

ANSYS reader 2-20

Apple Pict output 2-73

archive files 2-62

Area variable 4-14

Autorecovery 2-61

auxiliary clipping

by part 8-10

troubleshooting 6-26

AVI output 2-73

AVUS reader 2-21

Axis Specific Attributes dialog 8-21

## B

balloon help (Tool Tips) 5-4

Boundary File

format 11-155

boundary layer thickness 7-104

Boundary Layer Variables 7-103

access 7-106

boundary layer 7-103

boundary surfaces 7-104

define dependent variables 7-106

definitions

boundary layer thickness 7-104

displacement thickness 7-104

momentum thickness 7-104

shape parameter 7-105

skin friction coefficient 7-105

method 7-106

references 7-105

velocity magnitude gradient 7-104

Box Clip 7-52

Box clip part

Feature Detail Editor for 7-52

box tool

positioning 6-35

visibility toggle 6-30

## C

Calculator operations in created variables 4-42

case

delete 6-40

read data for new 6-40

replace existing 6-40

selecting a 6-41

viewport visibility specification 6-41

Case Map variable 4-19

- CEI
    - email address 1-14
    - telephone numbers 1-14
  - CFF Reader 2-22
  - CFX-4 reader 2-23
  - CGNS reader 2-24
  - clip
    - interactive using Cone Tool 7-53
    - interactive using Cylinder Tool 7-53
    - interactive using IJK Tool 7-43, 7-47
    - interactive using Line Tool 7-48
    - interactive using Plane Tool 7-51
    - interactive using Sphere Tool 7-53
    - interactive using XYZ Tool 7-45
  - clip animation
    - saving animation 7-44
  - Clip Create/Update Icon 7-43
  - Clip Editor 7-43
  - clip part
    - creating and updating 7-43
    - creation by revolution of 1D part 7-57
    - creation troubleshooting 7-59
    - creation using Box tool 7-52
    - creation using cylinder tool 7-53
    - creation using general quadric equation 7-58
    - creation using IJK clip tool 7-43
    - creation using line tool 7-48
    - creation using plane tool 7-50
    - creation using quadric tool 7-53
    - creation using revolution tool 7-55
    - creation using RTZ clip tool 7-46
    - creation using sphere tool 7-53
    - creation using XYZ clip tool 7-44
    - definition 7-42
  - Coefficient variable 4-19
  - Collaboration
    - opening 6-2
    - Web Publishing 12-8
  - color
    - by a variable 8-5
    - selection of constant 8-4
  - Color by RGB 6-8
  - Color by Textures 6-8
  - Color Editor 8-3, 8-4
  - Color Palette preferences 6-7
  - Color Selector Palette File format 10-4
  - Command dialog 2-59
    - opening 6-2
  - command files 2-58
  - Command Line Parameter preferences 6-8
  - Command Manual
    - opening 6-42
  - Complex
    - Argument variable 4-19
    - Conjugate variable 4-19
    - Imaginary variable 4-19
    - Modulus variable 4-19
    - Real variable 4-19
    - Transient Response variable 4-20
  - Complex variable 4-19
  - Component tensor variable 4-38
  - cone tool
    - positioning 6-37
    - visibility toggle 6-31
  - Connect Server dialog
    - opening 6-2
  - Connection Information File format 10-3
  - Context Files 2-65
    - restoring 2-65
    - saving 2-65
  - Context files
    - restoring 6-3
    - saving 6-3
  - Contour Create/Update Icon 7-35
  - Contour Editor 7-35
  - contour part
    - creating & updating 7-35
    - creation 7-36
    - creation troubleshooting 7-36
    - description 7-34
    - Feature Detail Editor for 7-36
    - sublevels 7-35
  - Copy Transformation State 9-2
  - Creation Attributes
    - Created Parts 3-14
    - IJK Node Ranges 3-13
    - Model Parts 3-13
  - cross references in User Manual 1-14
  - Curl variable 4-21
  - cursor tool
    - positioning 6-32
    - visibility toggle 6-29
  - Curve Specific Attributes dialog 8-23
  - cylinder tool
    - positioning 6-36
    - visibility toggle 6-30
- ## D
- data
    - Color Selector Palette file 10-4
    - Connection Information file 10-3
    - Data Reader Preferences file 10-8
    - Default False Color Map file format 10-6
    - Default Part Colors file 10-7
    - ens\_checker
    - EnSight Gold case file format 11-32
    - EnSight Gold geometry file format 11-6
    - EnSight Gold variable file format 11-41
    - EnSight Gold Wild Card Name Specification 11-40
    - EnSight5 binary file writing 11-129
    - EnSight5 geometry file format 11-119
    - EnSight5 measured/particle file format 11-126
    - EnSight5 result file format 11-123
    - EnSight5 variable file format 11-125



- EnSight5 wild card specification 11-125
- EnSight6 binary file writing 11-112
- EnSight6 case file format 11-97
- EnSight6 geometry file format 11-92
- EnSight6 measured/particle file format 11-112
- EnSight6 variable file format 11-104
- exported from analysis codes 2-57
- File Selection dialog 6-2
- formats 1-3
- Function Palette file format 10-4
- interfaces to 1-3
- palette file formats 10-4
- Parallel Rendering Configuration file 10-11
- Preference file formats 10-1
- reader types 1-3
- reading ABAQUS data 2-17
- reading ABAQUS ODB data 2-18
- reading ABAQUS\_FIL data 2-17
- reading ANSYS data 2-20
- reading AVUS data 2-21
- reading CFF data 2-22
- reading CFX-4 data 2-23
- reading CGNS data 2-24
- reading data using Translators 2-57
- reading DYTRAN data 2-41
- reading ESTET data 2-25
- reading Exodus data 2-27
- reading FAST UNSTRUCTURED data 2-31
- reading FIDAP data 2-32
- reading Fluent data 2-33
- reading FLUENT UNIVERSAL data 2-33
- reading HDF5 data 2-35
- reading LS-DYNA data 2-36
- reading Movie BYU data 2-39
- reading Movie.BYU data 2-39
- reading MPGS data 2-40
- reading MPGS4 data 2-40, 2-43
- reading N3S data 2-43
- reading NASTRAN op2 data 2-42
- reading NetCDF data 2-45
- reading PLOT3D data 2-46
- reading Radioss data 2-48
- reading SCRYU data 2-49
- reading Silo data 2-50
- reading STL data 2-52
- reading Tecplot data 2-54
- reading Vectis data 2-56
- supported elements 11-5, 11-91, 11-118
- transient 7-2
- translators 2-57
- troubleshooting loading of 2-10
- Window Position file 10-2
- Data Format
  - Extension Map File 10-9
- data formats supported 1-3
- Data Part Loader dialog
  - opening 6-2
- Data preferences 6-9
- Data Reader Preferences File Format 10-8
- dataset query 6-23
- dconfig 13-1
- Default False Color Map File format 10-6
- Default Part Colors File format 10-7
- Delete Button 3-3
- Density
  - Normalized 4-21
  - Normalized (log of) 4-21
  - Normalized Stagnation 4-21
  - Stagnation 4-22
  - variable 4-21, 4-22
- Desktop 5-1
- detached display 13-1
- Determinate tensor variable 4-39
- Developed Surface Create/Update Icon 7-114
- developed surface part
  - creating and updating 7-114
  - definition 7-112
  - developed projection definition 7-113
  - Feature Detail Editor for 7-114
  - open Developed Surface Editor 7-114
  - troubleshooting 7-115
- displacement thickness 7-104
- Display Walls 13-3
- Divergence variable 4-22
- documentation on-line guide 6-42
- DYTRAN reader 2-41
- E**
- Eigenvalue tensor variable 4-39
- Eigenvector tensor variable 4-39
- element
  - global label visibility toggle 6-27
  - label visibility by part 8-7
  - query 6-22
  - representation 3-20
- Element to Node variable 4-22
- elements
  - supported 11-5, 11-91, 11-118
- Elevated Surface Create/Update Icon 7-87
- Elevated Surface Editor 7-87
- elevated surface part
  - creating and updating 7-87
  - definition 7-86
  - Feature Detail Editor for 7-88
  - troubleshooting 7-88
- email address for CEI 1-14
- Empty parts
  - element variables for 11-57
  - nodal variables for 11-41
  - structured 11-16
  - unstructured 11-16
- EnLiten Output 12-8
  - scenario files 2-67
- ens\_checker
- EnSight

- documentation 1-13
  - gui overview 5-1
  - version in use 6-42
  - EnSight Data Formats 11-1
    - Boundary File Format 11-155
    - EnSight Gold Format 11-3
      - casefile 11-32
      - geometry file 11-6
      - Material Files Format 11-81
      - measured/particle file 11-80
      - partial variable values format 11-75
      - per\_element variable file 11-57
      - per\_node variable file 11-41
      - supported elements 11-5
      - transient single files 11-38
      - undefined variable values format 11-71
      - variable files 11-41
      - wild card name specification 11-40
    - EnSight5 Format 11-117
      - geometry file 11-119
      - measured/particle files 11-126
      - result file 11-123
      - supported elements 11-118
      - variable files 11-125
      - wild card name specification 11-125
      - writing binary files 11-129
    - EnSight6 Format 11-89
      - casefile 11-97
      - geometry file 11-92
      - measured/particle file 11-112
      - per\_element variable files 11-108
      - per\_node variable files 11-105
      - supported elements 11-91
      - transient single files 11-102
      - variable files 11-104
      - wild card name specification 11-104
      - writing binary files 11-112
    - FAST UNSTRUCTURED Results File Format 11-132
    - FLUENT UNIVERSAL Results File Format 11-136
    - Material File Format 11-81
    - Movie.BYU Results File Format 11-138
    - Particle Emitter File Format 11-159
    - Periodic Matchfile Format 11-150
    - PLOT3D Results File Format 11-141
    - Server-of-Servers Casefile Format 11-146
    - XY Plot Data File Format 11-153
  - EnSight Environment
    - saving 2-82
  - EnSight Gold Format 11-3
  - ensight\_reader\_extension.map 10-9
  - EnSight5 Utility Programs 12-2
  - Enthalpy
    - Normalized 4-23
    - Normalized Stagnation 4-24
    - Stagnation 4-23
    - variable 4-23
  - Entropy variable 4-24
  - EnVideo output 2-73
  - ESTET Data Part Loader dialog 2-26
  - ESTET reader 2-25
  - ESTET Vector Builder dialog 2-26
  - Exodus reader 2-27
- ## F
- failed element
    - by part 8-9
  - Fast Display representation 8-11
  - FAST UNSTRUCTURED reader 2-31
  - FAST UNSTRUCTURED Results File format 11-132
  - Feature Detail Editor
    - for Box clip parts 7-52
    - for contour parts 7-36
    - for developed surface parts 7-114
    - for elevated surface parts 7-88
    - for IJK clip parts 7-44
    - for isosurface parts 7-40
    - for isovolume parts 7-41
    - for line clip parts 7-49
    - for particle trace parts 7-75
    - for parts 6-5
    - for plane clip parts 7-51
    - for profile parts 7-84
    - for quadric equation clip parts 7-58
    - for quadric tool clip parts 7-54
    - for revolution clip parts 7-56
    - for RTZ clip parts 7-47
    - for Separation/Attachment Lines 7-102
    - for subset parts 7-80
    - for vector arrow parts 7-63
    - for XYZ clip parts 7-46
  - feature extraction
    - boundary layer variables 7-103
    - separation/attachment lines 7-99
    - shock surfaces/regions 7-93
    - vortex cores 7-89
  - Feature Icon Bar 5-2, 7-1
  - FIDAP reader 2-32
  - file
    - archiving 2-62
    - Color Selector Palette file 10-4
    - command 2-58
    - command playback troubleshooting 2-60
    - Connection Information file 10-3
    - context 2-65
    - Data Reader Preferences file 10-8
    - default command saving 2-58, 2-60
    - Default False Color Map file 10-6
    - Default Part Colors file 10-7
    - ensight\_reader\_extension.map 10-9
    - full backup saving 2-62
    - full backup troubleshooting 2-64
    - Function Palette file 10-4
    - Open 6-2
    - open
      - extension mapping 10-9
    - palette file formats 10-4
    - Parallel Rendering Configuration file 10-11

- scenario 2-67
- Window Position file 10-2
- File Selection dialog
  - opening 6-2
- Filtered Relative Helicity variable 4-27
- Flipbook Animation Editor 7-8
  - created data 7-7
  - created load 7-8
  - linear load 7-7, 7-8
  - mode shape load 7-8
  - mode shapes 7-7
  - saving animation 7-9
  - transient data 7-7
  - transient load 7-8
- Flipbook Animation Icon 7-8
- Flow Rate variable 4-25
- Flow variable 4-24
- Fluent reader 2-33
- FLUENT UNIVERSAL Results File format 11-136
- Fluid Shear Stress Max variable 4-25
- Fluid Shear variable 4-25
- Force variable 4-26
- frame
  - axis triad attributes 8-38
  - axis triad color 8-37
  - axis triad line width 8-37
  - axis triad visibility 8-37
  - computational symmetry 8-38
  - coordinate system 8-40
  - creation 8-36
  - definition 9-8
  - delete 8-43
  - description 8-34
  - global axis triad visibility toggle 6-27
  - part assignment 8-37
  - precise positioning 8-42
  - transform 9-11
    - rotation 9-12
    - translation 9-13
  - transformation type 8-43
  - translation scale 9-14
- Frame Axis Attributes dialog 8-38
- Frame Computational Symmetry Attributes dialog 8-38
- Frame Mode 8-34
- Frame Transform 9-11
- full backup
  - Restoring Full Backup Archive files 6-4
  - Save Full Backup Archive dialog 6-3
- Function Palette File format 10-4

## G

- General Attributes Feature Detail Editor 3-15
- General User Interface preferences 6-10
- geometric entities
  - Save Geometric Entities dialog 6-3
  - saving 2-69

- saving troubleshooting 2-71
- Getting Started Manual
  - opening 6-42
- global axis
  - triad visibility 8-48
  - triad visibility toggle 6-27
- Gradient Approximation variable 4-26
- Gradient Tensor Approximation variable 4-27
- Gradient Tensor variable 4-27
- Gradient variable 4-26
- graphic images 7-6
- graphic objects 7-6
- group operation 3-24
- GUI overview 5-1

## H

- HDF5 reader 2-35
- Helicity (relative filtered) variable 4-27
- Helicity (relative) variable 4-27
- Helicity Density variable 4-27
- Help
  - local 6-42
  - Main Menu button functions 6-42
- hidden line
  - by part 8-10
  - global toggle 6-25, 8-46
  - overlay 8-47
- Hidden Line Overlay dialog 8-47
- How To Manual
  - opening 6-42

## I

- Iblanking
  - Values in EnSight Gold 11-7
  - Values in EnSight6 11-92
  - Values in PLOT3D 11-141
- Iblanking Values variable 4-27
- Icon Bar Preferences dialog 6-10
- IJK clip part
  - Feature Detail Editor for 7-44
  - interactive creation 7-43, 7-47
- Image
  - Saving and Printing preferences 6-11
- image
  - output formats 2-73
  - Print/Save Image dialog 6-3
  - printing 2-73
  - saving 2-73
  - saving troubleshooting 2-77
- Immersive Displays 13-6
- Integral
  - Line 4-28
  - Surface 4-28
  - Volume 4-28
- Interactive Probe Query

- Display dialog 7-33
- Editor 7-32
- Icon 7-32
- IJK 7-32
- Node 7-32
- Point 7-32
- preferences 6-12
- Surface 7-32
- XYZ 7-32
- isosurface animation
  - saving animation 7-39
- Isosurface Create/Update Icon 7-39
- isosurface part
  - creating and updating 7-39
  - definition 7-38
  - interactive creation 7-39
  - open Feature Detail Editor for 7-40
  - open Isosurface Editor 7-39
- isovolume part 7-41

**J**

- JPEG output 2-73

**K**

- key function assignment 12-7
- Keyboard Macro Maker 12-7
- Keyframe Animation 7-12
- Keyframe Animation Speed/Actions dialog 7-15
- Kinetic Energy variable 4-23

**L**

- label
  - global element visibility toggle 6-27
  - global node visibility toggle 6-27
- legend
  - global visibility toggle 6-27
  - Show Legend 8-17
- Length variable 4-28
- License Agreement 6-42
- light source position 6-28
- lighting
  - special lighting 8-29
  - static lighting toggle 6-28
- line
  - representation 3-20
- Line Integral variable 4-28
- line tool
  - positioning 6-33
  - visibility toggle 6-29
- Local help 6-42
- Look At Point 9-19
- Look From Point 9-19
- LS-DYNA reader 2-36

**M**

- Mach Number variable 4-28
- macromake 12-7
- Main Menu
  - Case button functions 6-40
  - Edit button functions 6-5
  - File button functions 6-2
  - Help button functions 6-42
  - Query button functions 6-21
  - Tools button functions 6-29
  - View button functions 6-24
- Make Vector variable 4-28
- Massed Particle Scalar variable 4-28
- Mass-Flux Average variable 4-29
- Material Parts 7-108
- Materials Data
  - File format 11-81
- Math functions 4-41
- Max variable 4-29
- Medina bif/bof 2-19
- Min variable 4-29
- Mode
  - Annot 8-12
  - Frame 8-34
  - Part 8-2
  - Plot 8-18
  - VPort 8-25
- Mode Icon Bar 5-3
- Moment variable
  - about a point 4-29
  - Vector 4-30
- momentum thickness 7-104
- Momentum variable 4-30
- Mouse and Keyboard preferences 6-12
- Movie BYU reader 2-39
- Movie.BYU Results File format 11-138
- MPEG
  - output 2-73
- MPGS reader 2-40
- MPGS4 Utility Programs 12-6
- Multi-pipe Parallel Rendering 13-2

**N**

- N3S Part Creator dialog 2-43
- N3S reader 2-43
- NASTRAN op2 reader 2-42
- NetCDF reader 2-45
- node
  - display type 8-8
  - global label visibility toggle 6-27
  - label visibility by part 8-8
  - query 6-21
  - query (IJK) 6-22
- Node to Element variable 4-30

Normal Constraints variable 4-30  
 Normal vector variable 4-30  
 Normalize Vector variable 4-30  
 Nsided  
   Additional data for element block 11-16

## O

Offset Field 4-31  
 Offset Variable 4-31  
 on-line  
   Command Language Manual 6-42  
   documentation guide 6-42  
   Getting Started Manual 6-42  
   How To Manual 6-42  
   icon reference 6-42  
   license agreement 6-42  
   Local help 6-42  
   overview of EnSight 6-42  
   Release Notes 6-42  
   User Manual 6-42  
 orthographic view toggle 6-26  
 output formats 2-73

## P

Palette File format 10-4  
 Parallel Computation 1-13  
 Parallel Rendering 13-1  
   Annotations 13-13  
   Configuration File 10-11  
   Configuration File Format 13-2  
   dconfig 13-1  
   detached display 13-1  
   Display Walls 13-3  
   Immersive Displays 13-6  
   Multi-pipe 13-2  
   Stereo Display 13-14  
   Tips 13-14  
   Tracking 13-9  
 part  
   animation  
     saving animation 7-3, 8-49  
   assign color 8-3  
   auxiliary clipping 8-10  
   auxiliary clipping global toggle 6-26  
   computational symmetry in frame 8-38  
   Concepts 1-1  
   copy 3-25  
   created 3-2  
   creation of new 3-6  
   Data Part Loader dialog 6-2  
   definition 3-1  
   delete 3-24  
   Diffused Light 8-4  
   Displacement Attributes 3-21  
   display all in hidden line 6-25  
   editing 3-10  
   element bounding box representation 3-20

  element label visibility 8-7  
   element visual representation 8-6  
   empty  
     element variables 11-57  
     nodal variables 11-41  
     structured 11-16  
     unstructured 11-16  
   extract 3-26  
   failed element 8-9  
   fast display representation 8-11  
   Fill Pattern 8-4  
   frame assignment 8-37  
   General Attributes 3-15  
   Group 3-24  
   hidden line 8-10  
   hidden surface 8-10  
   Highlight Intensity 8-4  
   Highlight Shininess 8-4  
   identification of 3-9  
   IJK refinement 3-13  
   Lighting 3-18  
   line width 8-5  
   long list 3-2  
   Main Parts List 3-2  
   merge 3-26  
   mirror symmetry in frame 8-38  
   model 3-2  
   node display type 8-8  
   node label visibility 8-8  
   Node, Element, and Line Attributes 3-19  
   open Feature Detail for 6-5  
   operations on 3-23  
   overview 3-2  
   parent 3-2  
   Part Color, Lighting, Transparency Icon 8-3  
   preferences 6-14  
   query 6-22  
   Query/Plot Editor 7-22  
   reassign parent 3-5  
   rotational symmetry in frame 8-39  
   select all 3-23  
   select by keyword 3-23  
   selection of 3-8  
   separation/attachment lines 7-99  
   shock surfaces/regions 7-93  
   symmetry 8-7  
   translational symmetry in frame 8-39  
   types, symbols, and descriptions 3-4  
   Ungroup 3-24  
   visibility by viewport 8-5  
   vortex core 7-89  
 Part Displacement 8-6  
 Part Mode 8-2  
 Part Node Representation dialog 8-8  
 Part Shortcuts (Right-click) 3-27  
 Particle Emitter Data  
   File format 11-159  
 Particle Trace Create/Update Icon 7-69  
 Particle Trace Editor 7-69

- particle trace part
    - animation 7-70
      - saving animation 7-74
      - troubleshooting 7-72
    - creating and updating 7-69
    - creation with transient data 7-66
    - definition 7-65
    - Emission Detail Attributes dialog 7-73
    - emitter placement by picking 7-74
    - emitters 7-65
    - Feature Detail Editor for 7-75
    - integration method 7-66
    - interactive tracing 7-74
    - surface-restricted definition 7-66
    - troubleshooting 7-79
  - Parts
    - Materia 7-108
  - Paste Transformation State 9-2
  - PCL output 2-73
  - Performance preferences 6-14
  - Periodic Matchfile format 11-150
  - perspective view toggle 6-26
  - pick
    - Center of Transformation location 8-45
    - Cursor Tool location 8-45
    - Elements for Subset Parts 8-45
    - Elements to blank 8-45
    - Line Tool location 8-45
    - Look At Point 8-45
    - part 8-44
    - part position 8-44
    - Plane Tool location 8-44, 8-45
  - Pick Center of Transformation 8-45
  - plane tool
    - appearance 6-30
    - positioning 6-34
    - visibility toggle 6-30
  - Plot Mode 8-18
  - plot queried data 7-25
  - PLOT3D
    - Results File format 11-141
  - PLOT3D reader 2-46
  - plotter
    - axis attributes 8-21
    - curve attributes 8-23
    - delete 8-24
    - preferences 6-15
  - Plotter Specific Attributes dialog 8-19
  - point query 6-21
  - Postscript output 2-73
  - Preference File Formats 10-1
  - Preference Functions
    - icon bars 6-10
  - Preferences 6-7
    - Annotation 6-7
    - Color Palettes 6-7
    - Command Line Parameters 6-8
    - Data 6-9
    - General User Interface 6-10
    - Image Saving and Printing 6-11
    - Interactive Probe Query 6-12
    - Mouse and Keyboard 6-12
    - Parts 6-14
    - Performance 6-14
    - Plotter 6-15
    - Query 6-15
    - User Defined Input 6-16
    - Variables 6-17
    - View 6-19
  - Pressure
    - Coefficient 4-31
    - Dynamic 4-32
    - Normalized 4-32
    - Normalized (Log of) 4-32
    - Normalized Stagnation 4-33
    - Pitot 4-34
    - Pitot Ratio 4-34
    - Stagnation 4-33
    - Stagnation Coefficient 4-33
    - Total 4-35
    - variable 4-31
  - Print/Save Image dialog
    - opening 6-3
  - Profile Create/Update Icon 7-83
  - Profile Editor 7-83
  - profile part
    - creating and updating 7-83
    - definition 7-82
    - open Feature Detail Editor for 7-84
    - troubleshooting 7-85
  - Project Management 12-8
- ## Q
- quadric tool
    - positioning 6-36, 6-37
    - visibility toggle 6-30
  - query
    - At 1D Part Over Distance 7-26
    - At Cursor Over Time 7-29
    - At Element Over Time 7-27
    - At IJK Over Time 7-28
    - At Line Tool Over Distance 7-25
    - At Maximum Over Time 7-30
    - At Minimum Over Time 7-29
    - At Node Over Time 7-27
    - By Operating On Existing Queries 7-30
    - cursor 6-21
    - dataset 6-23
    - element 6-22
    - interactive probe 7-32
    - node 6-21
    - over distance 7-22
    - over time/distance 6-22
    - part 6-22
    - Read From An External File 7-31
    - Save Entity Query To dialog 7-24

- variable data over distance 7-22
- variable data over time 7-22
- Query Dataset dialog 6-23
- Query preferences 6-15
- Query Prompt dialog 6-21
- Query Text Information
  - from EnSight Message window 2-81
  - saving 2-80
- Query/Plot Editor 7-22
- Query/Plot Icon 7-22
- Quick Interaction Area 5-4
- Quit Confirmation dialog 2-59, 2-60
  - opening 6-4

## R

- Radioss reader 2-48
- reader
  - extension mapping file 10-9
- reader types 1-3
- readers
  - basics 2-2
  - data format
    - ABAQUS ODB 2-18
    - ABAQUS\_FIL 2-17
    - ANSYS 2-20
    - AVUS 2-21
    - CFF 2-22
    - CFX-4 2-23
    - CGNS 2-24
    - DYTRAN 2-41
    - EnSight Gold 2-13
    - EnSight5 2-14
    - EnSight6 2-13
    - ESTET 2-25
    - Exodus 2-27
    - FAST UNSTRUCTURED 2-31
    - FIDAP 2-32
    - Fluent 2-33
    - HDF5 2-35
    - LS-DYNA 2-36
    - Medina bif/bof 2-19
    - Movie BYU 2-39
    - MPGS 2-40
    - N3S 2-43
    - NASTRAN 2-42
    - NetCDF 2-45
    - PLOT3D 2-46
    - Radioss 2-48
    - SCRYU 2-49
    - Silo 2-50
    - STL 2-52
    - supported formats 1-3
    - Tecplot 2-54
    - Translators 2-57
    - Vectis 2-56
- EnSight native data format 2-12
- loading tips 2-9
- overview 2-2

- quick load 2-2
- troubleshooting loading data 2-10
- two-step load
  - data part loader 2-6
  - data reader 2-4
- user defined 2-15
  - ens\_checker
- Record Button 7-3, 7-9, 7-39, 7-44, 7-74, 8-49
- Rectangular to Cylindrical Vector variable 4-35
- region selector
  - visibility toggle 6-29
- Relative Helicity variable 4-27
- Release Notes
  - opening 6-42
- reset
  - tools 9-7
  - viewports 9-7
- Reset Tools and Viewport(s) dialog 9-7
- restoring context files 6-3
- revolution tool
  - positioning 6-38
  - visibility toggle 6-31
- RGB 6-8
- rotation
  - frame 9-12
  - global 9-3
  - using function keys 9-3
- RTZ clip part
  - Feature Detail Editor for 7-47

## S

- save
  - animation 7-3, 7-9, 7-39, 7-44, 7-74, 8-49
  - commands from current session
  - context files 6-3
  - geometric entities in EnSight Gold format 6-3
  - geometric information in VRML format 6-3
  - keyframe
    - animation 7-19
  - open Print/Save Image dialog 6-3
  - queried data 7-24
  - Save Full Backup Archive dialog 6-3
  - Save Geometric Entities dialog 6-3
  - scenario files 6-3
  - window positions 6-11
- Saving commands from current session
- scale
  - frame 9-14
  - global 9-6
- Scenario Files 2-67
  - saving 6-3
  - Web Publishing/Project Management 12-8
- SCRYU reader 2-49
- Select Button 3-3, 3-9
- Separation/Attachement Line part
  - Feature Detail Editor for 7-102
- Separation/Attachment Lines 7-99

- access 7-101
  - algorithms 7-100
  - define variables 7-101
  - method 7-101
  - references 7-100
  - thresholding 7-100, 7-101
  - velocity gradient tensor 7-99
  - Server-of-Servers
    - Casefile format 11-146
    - overview 1-12
  - SGI RGB output 2-73
  - shaded surface
    - by part 8-9, 8-10
    - global 8-45
    - global toggle 6-24
    - troubleshooting 6-25, 8-46
  - shape parameter 7-105
  - Shock Plot3d variable 4-35
  - Shock Surfaces/Regions 7-93
    - access 7-96
    - algorithms 7-94
    - define variables 7-96
    - method 7-97
    - references 7-95
    - thresholding 7-93, 7-97
  - Silo reader 2-50
  - skin friction coefficient 7-105
  - solution time definition 7-2, 7-21
  - Solution Time Editor 7-3
  - Solution Time Icon 7-3
  - Sonic Speed variable 4-36
  - Sort Button 3-3
  - Spatial Mean variable 4-35
  - Speed (sonic) variable 4-36
  - Speed variable 4-36
  - sphere
    - tool positioning 6-36
    - tool visibility toggle 6-30
  - static lighting toggle 6-28
  - Stereo Display 13-14
  - STL reader 2-52
  - Stream Function variable 4-36
  - Subset Parts Creation Editor 7-80
  - Swirl variable 4-36
- T**
- TARGA output 2-73
  - Tecplot reader 2-54
  - telephone numbers for CEI 1-14
  - Temperature
    - Normalized 4-37
    - Normalized (log of) 4-37
    - Normalized Stagnation 4-38
    - Stagnation 4-38
    - variable 4-37
  - Temporal Mean variable 4-38
  - tensor
    - data location 3-6
    - EnSight per node variable files 11-105
    - EnSight per-element variable files 11-68, 11-109
    - glyph part
      - create/update 7-116
      - symbol 3-5
    - variable
      - Component 4-38
      - Determinate 4-39
      - Eigenvalue 4-39
      - Eigenvector 4-39
      - Make 4-39
      - Tresca 4-39
      - VonMises 4-39
    - variable type 4-3
  - Text Annotation Creation dialog 8-13, 8-15
  - Textures 6-8
  - thresholding
    - separation/attachment lines 7-100
    - shock surfaces/regions 7-93
    - vortex cores 7-89
  - TIFF output 2-73
  - time-dependent data 7-2
  - tool
    - box tool positioning 6-35
    - box visibility toggle 6-30
    - cone tool positioning 6-37
    - cone visibility toggle 6-31
    - cursor visibility toggle 6-29
    - cylinder tool positioning 6-36
    - cylinder visibility toggle 6-30
    - line tool positioning 6-33
    - line visibility toggle 6-29
    - plane tool positioning 6-34
    - plane visibility toggle 6-30
    - positioning cursor tool 6-32
    - quadric tool positioning 6-36, 6-37
    - quadric visibility toggle 6-30
    - reset 9-7
    - revolution tool positioning 6-38
    - revolution visibility toggle 6-31
    - sphere tool positioning 6-36
    - sphere visibility toggle 6-30
  - Tool Tips 5-4
  - Trace Animation Settings dialog 7-71
  - Tracking 13-9
  - transformation
    - frame 9-11
    - global band zoom 9-6
    - global definition 9-3
    - global rotate 9-3
    - global scale 9-6
    - global translate 9-4
    - global zoom 9-5
  - Transformation Editor dialog
    - opening 9-1



- transient data 7-2
  - translation
    - frame 9-13
    - global 9-4
  - translators 2-57
  - Tresca tensor variable 4-39
  - Tresca variable 4-39
- ## U
- Undefined variable 11-71
  - Ungroup 3-24
  - User Defined Input preferences 6-16
  - User Defined Readers 2-15
  - User Manual
    - opening 6-42
  - Utility Programs 12-1
- ## V
- variable
    - activation 4-4
    - boundary layer variables 7-103
    - color palette 4-5
    - color palette editing 4-6
    - created
      - Area 4-14
      - Calculator operations 4-42
      - Case Map 4-19
      - Coefficient 4-19
      - Complex 4-19
      - Complex Argument 4-19
      - Complex Conjugate 4-19
      - Complex Imaginary 4-19
      - Complex Modulus 4-19
      - Complex Real 4-19
      - Complex Transient Response 4-20
      - Curl 4-21
      - Density 4-21, 4-22
      - Divergence 4-22
      - Dynamic Pressure 4-32
      - Element to Node 4-22
      - Enthalpy 4-23
      - Entropy 4-24
      - Filter Relative Helicity 4-27
      - Flow 4-24
      - Flow Rate 4-25
      - Fluid Shear 4-25
      - Fluid Shear Stress Max 4-25
      - Force 4-26
      - Gradient 4-26
      - Gradient Approximation 4-26
      - Gradient Tensor 4-27
      - Gradient Tensor Approximation 4-27
      - Helicity Density 4-27
      - Iblanking Values 4-27
      - Kinetic Energy 4-23
      - Length 4-28
      - Line Integral 4-28
      - Log of Normalized Density 4-21
      - Log of Normalized Pressure 4-32
      - Log of Normalized Temperature 4-37
      - Mach Number 4-28
      - Make Vector 4-28
      - Massed Particle Scalar 4-28
      - Mass-Flux Average 4-29
      - Math functions 4-41
      - Max 4-29
      - Min 4-29
      - Moment about a point 4-29
      - Moment Vector 4-30
      - Momentum 4-30
      - Node to Element 4-30
      - Normal 4-30
      - Normal Constraints 4-30
      - Normalize Vector 4-30
      - Normalized Density 4-21
      - Normalized Enthalpy 4-23
      - Normalized Pressure 4-32
      - Normalized Stagnation Density 4-21
      - Normalized Stagnation Enthalpy 4-24
      - Normalized Stagnation Pressure 4-33
      - Normalized Stagnation Temperature 4-38
      - Normalized Temperature 4-37
      - Offset Field 4-31
      - Offset Variable 4-31
      - Pitot Pressure 4-34
      - Pitot Pressure Ratio 4-34
      - Pressure 4-31
      - Pressure Coefficient 4-31
      - Rectangular To Cylindrical Vector 4-35
      - Relative Helicity 4-27
      - Shock Plot3d 4-35
      - Sonic Speed 4-36
      - Spatial Mean 4-35
      - Speed 4-36
      - Stagnation Density 4-22
      - Stagnation Enthalpy 4-23
      - Stagnation Pressure 4-33
      - Stagnation Pressure Coefficient 4-33
      - Stagnation Temperature 4-38
      - Stream Function 4-36
      - Surface Integral 4-28
      - Swirl 4-36
      - Temperature 4-37
      - Temporal Mean 4-38
      - Tensor Component 4-38
      - Tensor Determinate 4-39
      - Tensor Eigenvalue 4-39
      - Tensor Eigenvector 4-39
      - Tensor Make 4-39
      - Tensor Tresca 4-39
      - Tensor VonMises 4-39
      - Total Pressure 4-35
      - Velocity 4-39
      - Volume 4-40
      - Volume Integral 4-28
      - Vorticity 4-40
    - creation of new 4-10
    - Extended CFD Settings dialog 4-4, 6-18
    - Feature Detail Editor 4-6

- query over distance 7-22
    - query over time 7-22
    - Query/Plot Editor 7-22
    - types of 4-1
  - Variables preferences 6-17
  - Vectis reader 2-56
  - Vector Arrow Create/Update Icon 7-60
  - Vector Arrow Editor 7-60
  - vector arrow part
    - creating and updating 7-60
    - definition 7-60
    - density 7-62
    - open Feature Detail Editor for 7-63
    - Tip Settings dialog 7-61
    - toubleshooting 7-64
  - velocity gradient tensor
    - separation/attachment lines 7-99
    - vortex cores 7-89
  - velocity magnitude gradient vector 7-104
  - Velocity variable 4-39
  - Version of EnSight in use 6-42
  - view
    - perspective/orthographic toggle 6-26
  - View preferences 6-19
  - view states
    - saving/restoring 2-72
  - viewport
    - 2D 8-30
    - background color 8-27
    - border color 8-29
    - creation 8-28
    - delete 8-33
    - description 8-25
    - move back 8-28
    - move forward 8-28
    - precise positioning 8-30
    - reset 9-7
    - special lighting 8-29
    - standard layouts 8-28
    - visibility 8-26
    - visual attributes 8-30
  - Viewport Background Color Attributes dialog 8-27
  - Viewport Border Attributes dialog 8-29
  - Viewport Location Attributes dialog 8-30
  - Viewport Special Attributes dialog 8-30
  - Virtual Reality 13-1
    - Annotations 13-13
    - Configuration File Format 13-2
    - dconfig 13-1
    - detached display 13-1
    - Display Walls 13-3
    - Immersive Displays 13-6
    - Muti-pipe Parallel Rendering 13-2
    - overview 1-12
    - Stereo Display 13-14
    - Tips 13-14
    - Tracking 13-9
  - Volume Integral variable 4-28
  - Volume variable 4-40
  - VonMises variable 4-39
  - Vortex Cores 7-89
    - access 7-91
    - algorithms 7-90
    - caveats 7-90
    - define variables 7-91
    - method 7-92
    - references 7-90
    - thresholding 7-89, 7-92
    - velocity gradient tensor 7-89
  - Vorticity variable 4-40
  - VPort Mode 8-25
  - VR setup 13-1
  - VRML format 6-3
- ## W
- Web Publishing 12-8
  - Window Position File format 10-2
- ## X
- XY Plot Data
    - File format 11-153
    - saving and loading 2-78
  - XYZ clip part
    - interactive creation 7-45
- ## Z
- Z-Clip 9-17
    - float with transform 9-18
  - zoom
    - band global 9-6
    - global 9-5

# ENSIght® VERSION 8 END USER LICENSE AGREEMENT

UNLESS A SEPARATE LICENSE OR TRIAL AGREEMENT DOCUMENT EXISTS BETWEEN THE LICENSEE AND CEI OR AN AUTHORIZED CEI DISTRIBUTOR, THE TERMS AND CONDITIONS OF THIS AGREEMENT SHALL GOVERN YOUR USE OF VERSION 8 OF THE EnSight SOFTWARE. READ THIS LICENSE CAREFULLY BEFORE USING THE EnSight SOFTWARE. BY USING THE EnSight SOFTWARE YOU AGREE TO BE BOUND BY THIS AGREEMENT. IF YOU DO NOT ACCEPT OR AGREE TO BE BOUND BY THE TERMS OF THIS AGREEMENT, PROMPTLY RETURN THE EnSight SOFTWARE UNUSED WITHIN THIRTY (30) DAYS OF PURCHASE FOR A REFUND.

1. LICENSE GRANT. The Licensee is hereby granted by Computational Engineering International, Inc. ("CEI") a single, non-transferable and non-exclusive license to use the EnSight Software under the terms and conditions set forth below, in binary form only, and at the major release level indicated on the media used to deliver the licensed EnSight Software.

## 2. DEFINITIONS.

"Ancillary Software" includes translators, user defined data readers, tools, or other software which may from time to time be delivered with, but separate from, the "EnSight Software".

"End User" means one individual running an EnSight process.

"EnSight Purchase Agreement" means the document provided by Licensee to CEI which describes the type of installation Licensee is authorized to make.

"EnSight Documentation" means manuals, release or installation notes related to the EnSight Software, including electronic versions thereof.

"EnSight Software" means all of the CEI computer programs that constitute standard EnSight or EnSight Gold, the EnSight Documentation, the Third-Party Libraries (if licensed through CEI), and any backups or other copies.

"Maximum Seats" means the maximum authorized number of End Users who may simultaneously use the licensed copy of the EnSight Software as identified in the EnSight Purchase Agreement.

"Major Release Level" means all versions of the EnSight Software which are denoted by the same integer number to the left of the first decimal point in the specification of the release. For example, all versions denoted as EnSight 8.x are regarded as the same Major Release Level.

3. USAGE LIMITATIONS. Licensee acknowledges that the EnSight Software is proprietary and shall remain the property of CEI. This License is not a sale. Title to and ownership of the EnSight Software and any copies thereof, any patents, trademarks or

copyrights incorporated therein and to the CEI Proprietary information shall at all times remain with CEI. No rights to rent, loan, transfer, relicense, distribute, or otherwise assign any or all of Licensee's rights in the EnSight Software are granted. All rights not specifically granted to Licensee by this license shall remain in CEI. CEI may include features in the EnSight Software which prevent unlicensed use or use after license expiration. The license granted herein does not include provision of support and maintenance service or future releases or versions of the EnSight Software.

4. INSTALLATION. EnSight may be installed and used by the Licensee only in the manner indicated in the EnSight Purchase Agreement. End User may use EnSight only at his immediate workplace, unless otherwise authorized by CEI. Subject to request of and approval by CEI, Licensee may permanently or temporarily change the systems and/or networks upon which Licensee is authorized to use the EnSight Software. In either case, such change may result in additional charges to the Licensee. Licensee may duplicate the EnSight Software for backup, archiving, or security, provided that each copy includes all of the copyright or proprietary notices of the original. Licensee shall not clone, reverse assemble, or reverse compile any part of the EnSight Software or adopt any part of the EnSight Software as its own. CEI reserves the right to charge an upgrade fee for future Major Release versions of the EnSight Software.

5. PATENTS AND COPYRIGHTS. EnSight is copyrighted under the laws of the United States and international treaty provisions. Notwithstanding the copyright, the EnSight Software contains trade secrets and proprietary information of CEI. Licensee acknowledges that CEI owns these copyrights and has the following exclusive rights with regard to the EnSight Software: to reproduce it; to adapt, transform or rearrange it; to prepare derivative works from it; and to control its distribution. Licensee agrees not to act in contravention of any of CEI's intellectual property rights.

6. EnSight DOCUMENTATION. Licensee may use the EnSight Documentation only in support of its use of the licensed EnSight Software and may print or duplicate the Documentation (except any marked as proprietary), but only for its internal use and provided that each copy includes all of the copyright or related notices of the original.

7. WARRANTY; DISCLAIMER. CEI warrants that for a period of thirty (30) days after delivery of the EnSight Software, it will substantially conform in all material respects to the specifications set forth in CEI's published EnSight Documentation. If the EnSight Software does not meet this requirement, and Licensee notifies CEI within thirty (30) days after delivery, CEI will, at its option, repair or replace the effected EnSight Software. This warranty

excludes problems caused by acts of Licensee, unauthorized use of or causes external to the EnSight Software, and items which would be covered under Support and Maintenance service. CEI specifically does not warrant, guarantee, or make any representations regarding the use, or the results of the use, of the EnSight Software or Documentation in terms of correctness, accuracy, reliability, currentness, or otherwise. The entire risk as to the result produced by and the performance of the EnSight Software is assumed by the End User. CEI does not warrant that the execution of the EnSight Software will be uninterrupted or error free.

CEI WARRANTS THE ANCILLARY SOFTWARE ACCORDING TO THE TERMS FOUND IN THE LICENSE\_AND\_WARRANTY\_AND\_SUPPORT FILE OF THE src DIRECTORY OF THE SOFTWARE INSTALLATION. THE ABOVE WARRANTIES ARE CEI'S ONLY WARRANTIES AND ARE IN LIEU OF ALL IMPLIED WARRANTIES, INCLUDING BUT NOT LIMITED TO THE IMPLIED WARRANTIES OF MERCHANTABILITY AND FITNESS FOR A PARTICULAR PURPOSE, AND THE ABOVE REMEDIES ARE THE EXCLUSIVE REMEDIES FOR ANY BREACH OF WARRANTY. NO ORAL OR WRITTEN INFORMATION OR ADVICE GIVEN BY CEI OR ITS EMPLOYEES SHALL CREATE A WARRANTY OR IN ANY WAY INCREASE THE SCOPE OF THIS WARRANTY, AND LICENSEE MAY NOT RELY ON SUCH INFORMATION OR ADVICE. LICENSEE'S SOLE REMEDY AND CEI'S SOLE OBLIGATION SHALL BE GOVERNED BY THIS AGREEMENT. LICENSEE EXPRESSLY AGREES THAT IN NO EVENT SHALL CEI BE LIABLE FOR ANY CONSEQUENTIAL, INCIDENTAL, OR SPECIAL DAMAGES ARISING FROM THE BREACH OF WARRANTY, NEGLIGENCE, OR ANY OTHER LEGAL THEORY, WHETHER IN TORT OR CONTRACT, EVEN IF CEI HAS BEEN APPRISED OF THE LIKELIHOOD OF SUCH DAMAGES OCCURRING, INCLUDING WITHOUT LIMITATION DAMAGES FROM INTERRUPTION OF BUSINESS, LOSS OF PROFITS OR BUSINESS OPPORTUNITIES, LOSS OF USE

OF SOFTWARE, LOSS OF DATA, COST OF RECREATING DATA, COST OF CAPITAL, COST OF ANY SUBSTITUTE PRODUCTS, OR LOSSES CAUSED BY DELAY. FURTHER, CEI SHALL NOT BE RESPONSIBLE FOR ANY DAMAGES OR EXPENSES RESULTING FROM ALTERATION OR UNAUTHORIZED USE OF THE EnSight SOFTWARE OR FROM THE UNINTENDED AND UNFORESEEN RESULTS OBTAINED BY LICENSEE AND RESULTING FROM SUCH USE. IN ANY EVENT, CEI'S MAXIMUM LIABILITY UNDER ANY LICENSE OR OTHERWISE FOR ANY REASON SHALL NOT EXCEED THE TOTAL AMOUNT PAID BY LICENSEE FOR THE CEI EnSight SOFTWARE, EXCLUSIVE OF ANY SUPPORT AND MAINTENANCE FEES PAID. THE

EXISTENCE OF MORE THAN ONE CLAIM WILL NOT ENLARGE OR EXTEND THE LIMIT.

8. **THIRD-PARTY RIGHTS AND LICENSE.** If Third-Party owned graphics libraries are sublicensed to Licensee by CEI, it will be so noted in the EnSight Purchase Agreement. All terms related to the EnSight Software, including and without limitation, terms related to limitation of remedies and restrictions on use, apply to the Third-Party Software.
9. **LICENSE MANAGER SOFTWARE.** If Licensee is authorized to install and use License Manager Software to enable the EnSight Software to execute on multiple computer systems on a network, it will be so noted in the EnSight Purchase Agreement. All terms related to the EnSight Software, including and without limitation, terms related to limitation of remedies and restrictions on use, apply to the License Manager Software. Licensees authorized to use License Manager Software may install multiple redundant license servers on the same network subnet node. Installation of multiple redundant license servers on different subnet nodes requires Licensee to submit a written request to CEI, stating that the use of multiple servers will not enable more than the maximum seats of the software to be used. Furthermore, Licensee agrees to submit License Manager log files upon request to CEI for verification. Use of EnSight on a network is restricted to one geographic location, unless otherwise authorized by CEI.
10. **U. S. GOVERNMENT RESTRICTED RIGHTS.** If the Licensee is the USA Department of Defense ("DOD"), the licensed EnSight Software is subject to "Restricted Rights" as that term is defined in the DOD Supplement to the Federal Acquisition Regulations ("DFARS") section 252.227-7013(c). If the Licensee is any unit or agency of the U.S. Government other than the DOD, the Government's rights in the EnSight Software will be defined in paragraph 52.227-19(c)(2) of the Federal Acquisition Regulations ("FAR"). Use, duplication, reproduction, or disclosure by the U.S. Government is subject to such restrictions. Contractor/ Manufacturer is: Computational Engineering International, Inc., 2166 N. Salem Street, Suite 101, Apex, NC 27523, USA.
11. **INVOICES; PAYMENT; TAXES.** Licensee agrees to pay the License Fee(s) owed for this Software License as shown on a separate Invoice(s) from CEI. All Payments will be in U. S. Dollars. Payment is due within thirty (30) days after the date of each Invoice. Payment is considered made when good funds are received by CEI. To those Licensees leasing an EnSight Software License, future Invoices for the EnSight Software Lease Fee will be issued yearly in the month prior to that in which the initial payment of the EnSight Software Lease Fee was made to CEI. Licensees located in the State of North Carolina, USA are responsible for payment to CEI of all applicable State and Local sales taxes.

Licensees located in any State other than North Carolina in the USA are directly responsible for payment of all State and Local sales taxes applicable at their location. Licensees located in any Country other than the USA are directly responsible for payment of all import and sales taxes to the responsible government(s) at their location. Licensees who have obtained a License through an authorized Distributor of CEI agree to comply with the Distributor's payment terms and conditions.

12. SEVERABILITY. If any provision of this Agreement shall be held by a court of competent jurisdiction to be contrary to law or not enforceable, the remaining provisions of this Agreement shall remain in full force and effect.
  13. EXPORT. This License and the rights granted hereunder are subject to compliance by Licensee with all laws, regulations, orders, or other regulations relative to export or redistribution of Licensed Software that may now or in the future be imposed by the government of the United States or any agency thereof or of any other country into which licensed EnSight Software may be transported and any act of noncompliance shall immediately terminate this License. If the Licensee imports the licensed copy of the EnSight Software into a country in which CEI has an authorized Distributor, then if the License was purchased the Licensee shall pay to CEI a Penalty Fee equal to one half the cost of the original Purchased License Fee.
  14. TERM. If a License for the EnSight Software was purchased by Licensee, then this license is valid upon the date of initial payment of the Purchase License Fee to CEI by Licensee and shall continue until an event of Termination. If a License for the EnSight Software was leased by Licensee, then this license is valid for twelve (12) months from the date of initial payment of the Lease License Fee to CEI by Licensee and shall renew for subsequent twelve (12) month periods from the date Licensee pays the amounts indicated on each yearly invoice, according to Section 11, unless an event of Termination occurs.
  15. TERMINATION. This Software License Agreement shall terminate upon occurrence of any of the following events: (i) the failure of Licensee to observe or perform any of the material covenants, terms, and conditions of this Agreement where such nonperformance is not fully remedied by Licensee within thirty (30) days after written notice by CEI; (ii) any breach of Sections 3, 4, 6, 7, 8, 9, or 10 hereof (effective immediately); (iii) the filing of a petition for Licensee's bankruptcy, whether voluntary or involuntary, or an assignment of Licensee's assets made for the benefit of creditors, or the appointment of a trustee or receiver to take charge of the business of Licensee for any reason, or Licensee's becoming insolvent or voluntarily or involuntarily being dissolved; or (iv) the use of a license purchased at an academic discount for purposes other than teaching or academic research.
- Termination of this Agreement under Section 15 shall be in addition to, and not a waiver of, any remedy at law or in equity. Notwithstanding the foregoing, the provisions of Sections 4, 6, 7, 8, 9, and 10 shall survive the termination of this agreement. Upon termination of this Software License Agreement, Licensee shall promptly cease to use and shall return to CEI all copies of the EnSight Software, the Ancillary Software, and EnSight Documentation.
16. GENERAL. Licensee may not assign or transfer its rights or obligations under this Agreement without the prior written consent of CEI. The parties agree that this Agreement shall be governed and construed by the laws of the State of North Carolina, USA, and that no conflict-of-laws provision shall be invoked to permit the laws of any other state or jurisdiction. Any legal action must be filed within one (1) year after the cause for such action arises with the court of jurisdiction in the State of North Carolina, USA. All preprinted additional or different terms on any purchase order forms or other documents received from Licensee are deemed deleted and Licensee agrees that such terms shall be void even if the Licensee's documentation indicates the terms therein take precedence over other documents. This Software License Agreement, together with the most recent EnSight Purchase Agreement delivered to CEI by Licensee, constitutes the entire agreement of the parties and supersedes any prior understandings relating to the subject matter, and may be amended or supplemented only in a written agreement signed by both an officer of CEI and the Licensee.
  17. RESTRICTION ON USE OF TrackdAPI SOFTWARE, developed and owned by VRCO Inc., an Delaware corporation, with principal place of business at 192 Ballard Ct. Suite 300, Virginia Beach, VA 23462; here after referred to as "VRCO". Licensee is prohibited from the distribution, transfer, modification, or alteration of the TrackdAPI software and associated written materials and/or documentation ("TrackdAPI Software") and shall abide by the following:
    - I. PROPRIETARY RIGHTS. Licensee agrees that its use of TrackdAPI Software is a license only and VRCO owns all right, title, and interest in the TrackdAPI Software including any patents, trademarks, trade names, inventions, copyrights, know-how and trade secrets relating to the design, manufacture, operation or service of the TrackdAPI Software. Nothing in this agreement should be construed as transferring any aspects of such rights to Licensee or any third party.
    - II. WARRANTY DISCLAIMER. THE LICENSED TrackdAPI Software IS PROVIDED "AS IS" WITHOUT WARRANTY OF ANY KIND, EXPRESS OR IMPLIED, INCLUDING BUT NOT LIMITED TO THE IMPLIED WARRANTIES OR

MERCHANTABILITY AND FITNESS FOR A PARTICULAR PURPOSE. THE ENTIRE RISK AS TO THE QUALITY AND PERFORMANCE OF THE LICENSED TrackdAPI Software IS ON THE LICENSEE.

III. LIMITATION OF LIABILITY. IN NO EVENT SHALL VRCO BE LIABLE FOR COSTS OF PROCUREMENT OF SUBSTITUTE GOODS OR SERVICES OR FOR ANY SPECIAL, CONSEQUENTIAL, INCIDENTAL, OR INDIRECT DAMAGES OR LOST PROFITS ARISING OUT OF THIS AGREEMENT OR USE OF THE TrackdAPI Software, HOWEVER CAUSED, ON ANY THEORY OF LIABILITY, AND EVEN IF VRCO HAS BEEN ADVISED OF THE POSSIBILITY OF SUCH DAMAGES. LICENSEE AGREES VRCO'S LIABILITY ARISING OUT OF CONTRACT, NEGLIGENCE, STRICT LIABILITY IN TORT OR WARRANTY SHALL NOT EXCEED ANY AMOUNTS PAID BY LICENSEE FOR THE TrackdAPI Software IDENTIFIED ABOVE.

# ENSI<sup>®</sup>GT VERSION 8 SUPPORT AND MAINTENANCE SERVICE AGREEMENT

UNLESS A SEPARATE AGREEMENT FOR SUPPORT AND MAINTENANCE SERVICES EXISTS BETWEEN THE LICENSEE AND CEI OR AN AUTHORIZED CEI DISTRIBUTOR, THE TERMS AND CONDITIONS OF THIS AGREEMENT SHALL GOVERN CEI'S PROVISION OF AND LICENSEE'S USE OF AND PAYMENT FOR SUCH SERVICES.

1. **GENERAL.** The EnSight Software Licensee and Computational Engineering International, Inc., ("CEI") agree that the following terms and conditions apply to the provision of Software Support and Maintenance Service.

2. **DEFINITIONS.**

"Ancillary Software" includes translators, user defined data readers, tools, or other software which may from time to time be delivered with, but separate from, the "EnSight Software".

"EnSight Purchase Agreement" means the document provided by Licensee to CEI which describes the type of installation Licensee is authorized to make.

"EnSight Documentation" means manuals, release or installation notes related to the EnSight Software including electronic versions thereof.

"EnSight Software" means all of the CEI computer programs that constitute standard EnSight or EnSight Gold, the EnSight Documentation, the Third-Party Libraries (if licensed through CEI, as called out on Schedule A), and any backup or copies thereof.

"Major Release Level" means all versions of the EnSight Software which are denoted by the same integer number to the left of the first decimal point in the specification of the release.

3. **SOFTWARE SUPPORT SERVICE.** During the term of this Agreement CEI will provide technical support as described below to the EnSight Software Licensee in its use of the EnSight Software, provided that Licensee has an active License to use the EnSight Software from CEI. CEI will provide telephone consultation on problems encountered in using the EnSight Software during the Prime Time period defined as Monday through Friday, from 8:00 AM to 5:00 PM, USA Eastern Standard Time or Eastern Daylight Time, excluding U. S. Holidays. Licensee is limited to five (5) hours per month of telephone consultation. Alternatively, support requests can be made to CEI via FAX or Electronic mail.

EnSight U.S. Support Telephone Number:(800) 551-4448  
Outside U.S. Support Telephone Number:(919) 363-0883  
EnSight Support FAX Number: (919) 363-0833  
EnSight Support Email address: support@ensight.com

4. **SOFTWARE MAINTENANCE SERVICE.** During the term of this Agreement CEI will maintain the

EnSight Software provided that Licensee has an active License to use the EnSight Software from CEI. CEI will distribute to Licensee one copy of new minor releases of the major release listed on the media used to deliver the EnSight Software including EnSight Documentation as they become available, subject to the terms and conditions of this Agreement. CEI may modify the terms, conditions, and prices for services applicable to future major releases.

5. **EXCLUDED SOFTWARE.** NO SUPPORT OR MAINTENANCE SERVICE FOR THE ANCILLARY SOFTWARE IS OFFERED OR PROVIDED BY THIS AGREEMENT EXCEPT AS NOTED IN THE LICENSE\_AND\_WARRANTY\_AND\_SUPPORT FILE OF THE src DIRECTORY OF THE SOFTWARE INSTALLATION.

6. **LICENSEE AGREEMENTS FOR SOFTWARE SUPPORT AND SOFTWARE MAINTENANCE.** In order to permit CEI to supply the Software Support and Software Maintenance specified above:

(i). If third party graphic libraries accompanied the EnSight Software delivered to Licensee, as noted in the EnSight Purchase Agreement, and such third party issues a new version of such library software which CEI incorporates into the Software, then Licensee must comply with any additional licensing or fee requirements imposed by such third party.

(ii). Licensee agrees to install minor releases, fixes, circumventions, and corrective code to the EnSight Software in a reasonable time after receipt thereof.

(iii). Licensee agrees to be responsible for the installation and administration of the EnSight Software.

(iv). Upon request by CEI, Licensee will provide the name, address, telephone and FAX number, and Email address (if available) of the Licensee's contact individual for communicating problems and solutions.

7. **FEES.** If Licensee is Leasing an EnSight Software License, then the cost of the Software Support and Maintenance Service is included in the annual EnSight Software License Lease Fee.

If Licensee has Purchased an EnSight Software license, then there is no separate fee for Software Support and Maintenance Service for a period of twelve (12) months from the date of the initial payment of the EnSight Software License Purchase Fee to CEI. Licensee agrees to subsequently pay the annual EnSight Software Support and Maintenance Service Fee(s) for subsequent twelve (12) month periods at the then current rates when invoiced. If an additional yearly charge for Support and Maintenance Service for third-party graphics libraries of license manager software accompanying the EnSight Software is required, Licensee agrees to pay the additional charges at the same time and at the then current rates.

Licensees located in any State other than North Carolina in the USA are directly responsible for

payment of all State and Local taxes applicable at their location for this Service. Licensees located in any Country other than the U.S. are directly responsible for payment of all taxes to the government(s) at their location for this Service. Licensees who have obtained a License through an authorized Distributor of CEI agree to comply with the Distributor's payment terms and conditions.

8. **LIMITATION OF REMEDY AND DISCLAIMER.** CEI WILL USE ITS DILIGENT EFFORTS TO PROVIDE THE SUPPORT AND MAINTENANCE SERVICES SPECIFIED HEREIN. CEI MAKES NO OTHER WARRANTY OF ANY KIND OR NATURE WITH REGARD TO THE SERVICES TO BE PERFORMED BY CEI UNDER THE TERMS OF THIS AGREEMENT AND ANY IMPLIED WARRANTIES, INCLUDING THE IMPLIED WARRANTIES OF FITNESS FOR A PARTICULAR PURPOSE AND MERCHANTABILITY, ARE HEREBY DISCLAIMED. THE REMEDIES SET FORTH IN THIS AGREEMENT ARE LICENSEE'S EXCLUSIVE REMEDIES FOR ANY BREACH OF THE TERMS OF THIS AGREEMENT. CEI WILL NOT BE LIABLE IN ANY EVENT FOR LOSS OF OR DAMAGE TO REVENUES, PROFITS, OTHER ECONOMIC LOSS OR GOODWILL OR OTHER CONSEQUENTIAL, SPECIAL, INCIDENTAL OR INDIRECT DAMAGES ARISING OUT OF OR IN CONNECTION WITH THE PERFORMANCE OF ITS OBLIGATIONS HEREUNDER, INCLUDING ANY LIABILITY FOR NEGLIGENCE WITH RESPECT TO SERVICE PROVIDED UNDER THIS AGREEMENT EVEN IF CEI HAS BEEN ADVISED OF THE POSSIBILITY OF SUCH DAMAGES. IN ANY AND ALL CASES, CEI'S MAXIMUM LIABILITY IN CONNECTION WITH OR ARISING OUT OF THIS AGREEMENT SHALL NOT EXCEED THE EQUIVALENT OF ONE (1) YEAR OF CHARGES FOR THE RELEVANT SERVICE. THE EXISTENCE OF MORE THAN ONE CLAIM WILL NOT ENLARGE OR EXTEND THE LIMIT.
9. **INVOICES AND PAYMENT.** To those Licensees who have purchased an EnSight Software License, future Invoices for the EnSight Software Support and Maintenance Fee(s) will be issued yearly in the month prior to that in which the initial payment of the EnSight Software License Purchase Fee was made to CEI. Invoices shall be due and payable within thirty (30) days of date of invoice. All payments will be in U. S. Dollars.
- Payment of invoice is considered made when good funds are received by CEI.
10. **OBSOLETE PRODUCTS.** CEI will continue to provide Software Support Service for the release prior to the most current release for a period of twelve (12) months after the release date of the most current release. At that time, the previous release is designated as Obsolete and Software Support Service for the Obsolete release shall thereafter be discontinued.
11. **TERM.** The Term of this Agreement shall be from

the date payment from Licensee is first received by CEI for the EnSight Software License Purchase Fee or the EnSight Software License Lease Fee, whichever is applicable, until an event of Termination.

12. **TERMINATION.** EnSight Software Support and Software Maintenance Service hereunder may be terminated as follows: (A) by Licensee or CEI to be effective during or after the first year of such Service upon giving ninety (90) days written notice; (B) by CEI with respect to Obsolete Products; (C) by CEI immediately and without notice, with respect to the EnSight Software, the license for which has expired or been terminated; (D) by CEI after ten (10) days subsequent to providing notice to Licensee upon either (i) nonpayment by Licensee of any Invoiced amount due under this Agreement or the EnSight End User License Agreement; or (ii) nonperformance by Licensee of any other material term or condition of this Agreement.
13. **ASSIGNMENTS.** The Licensee may not assign or transfer its rights or obligations under this Agreement, in whole or in part, without the written consent of CEI.
14. **APPLICABLE LAW.** The parties agree that this Agreement shall be governed and construed by the laws of the State of North Carolina, USA, and that no conflict-of-laws provision shall be invoked to permit the laws of any other state or jurisdiction. Any legal action must be filed within one (1) year after the cause for such action arises with the court of jurisdiction in the State of North Carolina, USA.
15. **GENERAL.** The terms and conditions stated in this Agreement constitute the complete and exclusive statement of the Agreement between Licensee and CEI and supersede all prior oral and written statements of any kind whatsoever made by either party or their representatives.
- All preprinted additional or different terms on any purchase order forms or other documents received from Licensee are deemed deleted and Licensee agrees that such terms shall be void even if the Licensee's documentation indicates the terms therein take precedence over other documents.
- Any waivers of or amendments to the terms and conditions of this Agreement, to be effective, must be in writing and signed by an officer of CEI and Licensee.
- CEI Address:  
Computational Engineering International, Incorporated  
2166 N. Salem Street, Suite 101, Apex, North Carolina  
27523  
USA